



CMT X Series

Fast x Smart x Reliable

cMT X Series

Full Featured Smart HMI

The cMT X Series is more than its outstanding performance. It is also the software focus on data integration, monitoring and the cloud that truly makes the cMT X the smart HMI to have.

✓ Performance

Quad-core CPU

✓ Display

178° Wide Viewing Angle

✓ Capacity

4GB Flash / 1GB RAM

✓ Connectivity

400+ Communication Drivers



Premium Protection⁺

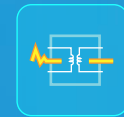

Power Isolation



PCB Coating



NEMA4/
IP66



CE / UL
Certification

01

Powerful Software Features

EasyBuilder Pro p.03

02

Data Integration

OPC UA / Database / MQTT p.05

03

Mobile Monitoring

WebView / cMT Viewer / VNC Viewer p.06

04

Weincloud

Dashboard / EasyAccess 2.0 p.07

05

Wireless Solution

cMT X Series+ M02 WiFi Module p.09

06

Headless HMI

cMT-FHDX / cMT-SVRX p.10

07

Programmable Control

CODESYS / iR Series p.11

cMT X Series Model Types

p.12

Specifications and Dimensions

p.13

Solution 01

Powerful Software Features

EasyBuilder Pro is an editing software that makes creating a unique HMI project easy for everyone, providing an intuitive and aesthetically pleasing UI, useful diagnostic tools, and abundant design resources.

Ribbon Style

An intuitive and aesthetically pleasing user interface.

Window Layers

Edit complex projects with ease.

Tool: cMT Diagnoser

Stay on top of your HMI, from data monitoring, communication testing, to code debugging.

Tool: Online Simulator

Verify communication and preview operation result without an actual HMI.



if Simplified Design Process: Condition Feature

Construct if/else logics with graphical UI instead of codes.

Simplified Design Process: Action Feature

Configure numerous actions with graphical UI to be triggered at once.

2000+ Picture Libraries

Make an eye-catching project with a variety of picture resources.

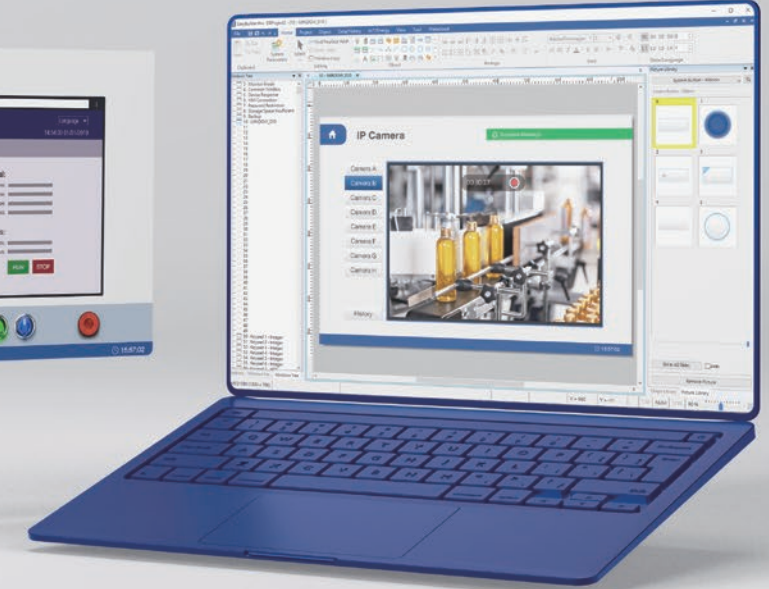
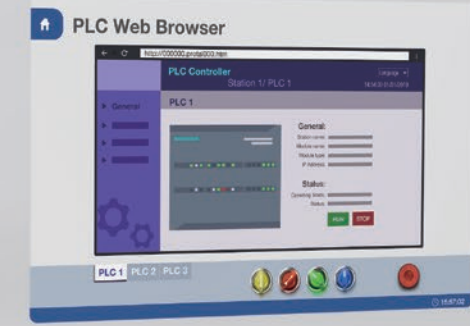
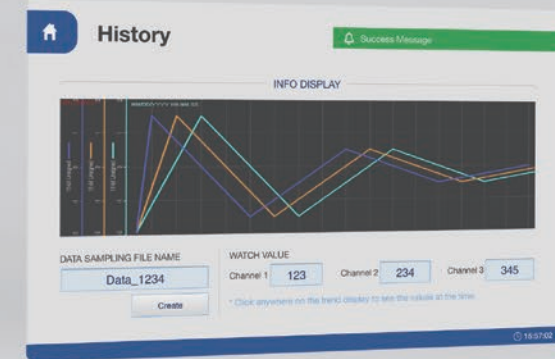

In addition to common objects such as shapes, buttons, switches, numeric displays, basic charts, and recipes, EasyBuilder Pro further empowers the HMI with advanced capabilities.

Multimedia Support

Watch IP/USB Camera feeds on HMI or use Media Player to play HD videos on HMI.

File Transfer and Access

Use FTP server access to send various files and screenshots on the HMI to the server, or download PDF files, images, and videos from the server to view on the HMI.

Web Browser

Access the webpages of a PLC, a controller, or an embedded device to adjust its system parameters or monitor its status.

Data Processing

Synchronize historical data of Data Log, Event Log, and Operation Log to an external database, and, where necessary, check for their data integrity.

Safety and Security

Login via the HMI's own security server, or via external server in LDAP mode which features centralized account administration for more effective security management.

Feature Customization

Use JavaScript to customize features beyond what is provided and connect to API to enable applications.



Solution 02

Data Integration

400+ device protocols as well as IIoT protocol support and database connectivity aid in data integration.



Industrial Protocol Integration

Supported industrial protocol standards include OPC UA and Modbus TCP/IP, interconnecting all onsite devices and facilitating integration with the hosts.

Why OPC UA?

OPC UA is the de-facto industrial communication standard. It features openness, interconnectivity, interoperability, security and reliability.



MQTT Cloud Integration

The cMT X Series supports MQTT, a lightweight protocol that makes it easy to send telemetry to cloud and big data systems.

Accelerating IoT Integration

In EasyBuilder Pro, MQTT connection setup to AWS, Azure, and Google IoT platforms are greatly simplified.



Database Integration

Send data to a database or an IT System where data can then be more efficiently processed using SQL commands.

Supported Databases

Database support includes MySQL, MS SQL and their related version: MariaDB, Azure SQL Database

Solution 03

Mobile Monitoring

Choose the best means of monitoring depending on your application.



VNC Viewer

Monitor the HMI with VNC Viewer.



WebView

Monitor the HMI on a web browser, be it Chrome or Safari.

EasyWeb

View historical datalog and event log in a webpage.



cMT Viewer App

Use the cMT Viewer for secure and efficient HMI monitoring featuring:

- Cross-platform support (PC/Mobile)
- Multi-HMI / multi-user monitoring
- Control Token safety mechanism

Monitor Mode

View up to 20 HMI screens concurrently within a screen for maximum efficiency.



Google Play



App Store

Solution 04

Weincloud

Dashboard × EasyAccess 2.0

With Dashboard and EasyAccess 2.0, begin remote monitoring or maintenance anywhere and anytime.



Dashboard Dashboard Monitoring

Dashboard visualization helps obtain status overview and gain insights instantly.

Easy Deployment

No server hosting required.

Intuitive UI

Build a dashboard with the web-based, drag and drop editor in no time.

Data Visualization

Aggregate data from different sources and display them on a single page.

Widget Variety

Create a dashboard of your own, choosing from a variety of widgets.

Secure Transmission

Data security backed by full SSL/TLS encryption.

Data Integrity

Data completeness ensured by the data retention feature in the event of network issue.



EasyAccess 2.0 Remote Connection Service

Remote connection, alarm push notifications, and PLC pass-through make it possible to monitor HMI or carry out maintenance anywhere, anytime.

Solution 05

Wireless Solution

Modular WiFi design enables wireless connectivity for more HMIs, helping to tackle situations where wiring may be difficult.



cMT1106X / cMT2108X2 / cMT3102X / cMT3108XH / cMT3108XP



cMT X Series + M02 WiFi Module

Less Delay | Higher Speed | Wider Range | Better Deployment

1. IEEE 802.11b/g/n with WPA/WPA2 security allows safe transmission of data in complex industrial environments.
2. The magnetic mount antenna can be installed at an optimal location to maximize signal strength.
3. WiFi hotspot makes it easy to access HMI.

Solution 06

Headless HMI

Compact and well-suited in a control cabinet, a headless HMI can be used with screens of various sizes or monitored with cMT Viewer on a tablet, mobile phone, or computer.

cMT-FHDX-820

Supporting video output via HDMI, its size and resolution is not limited by current HMI offerings. Software features are comparable to those of cMT X Advanced.



cMT-SVRX-820/822

The latest server-type HMI is the perfect manifestation of the cMT X architecture, and the cMT Viewer app is all it needs to start mobile monitoring.

* Other wireless models: cMT-SVR-200 / cMT-SVR-202

Solution 07

Programmable Control

HMI Integrated with CODESYS PLC Controller System + iR Series Module.



Controller

HMI + CODESYS

An HMI-CODESYS integrated controller, where the CODESYS runs independently on one CPU core; i.e., HMI and CODESYS do not affect each other.

cMT-CTRL01

An IIoT controller that integrates CODESYS and IIoT Gateway.



iR Series

iR-ETN40R / iR-ETN40P

A compact device that integrates an Ethernet coupler and Digital I/O, providing a one-piece, cost-effective solution.

I/O Module

Coupler protocol: MODBUS TCP/IP, EtherNet/IP, CANopen and EtherCAT
I/O Module: Digital and Analog I/O, Temperature Module, and Single-axis Motion Control Module.

Basic

meeting the essential needs

cMT X Basic features essential UI elements and 400+ PLC communication protocols for essential needs of industrial automation.

Standard

enhanced for smart applications

In addition to all the features on cMT X Basic, cMT X Standard also features enhancements in multimedia and mobile monitoring to meet the needs for a range of applications.

Advanced

all-around smart HMI

Supporting everything cMT X Basic and Standard have, cMT X Advanced also excels in cross-platform integration given its IIoT protocol capabilities.

Headless HMI

going beyond size boundaries

Headless HMI works independently without a screen and can be monitored on apps or on external screens of various sizes.



cMT X Series Model Types

cMT X Series is offered in multiple levels to address different requirements.

● Naming Convention ●

cMT 3 07 2 X *

Series Name
cMT X

Category

- 1 Basic
- 2 Standard
- 3 Advanced

Screen Size

- | | | | |
|----|-------|----|-------|
| 05 | 4.3" | 12 | 12.1" |
| 07 | 7" | 15 | 15" |
| 09 | 9.7" | 16 | 15.6" |
| 10 | 10.1" | | |

Ethernet Port

- 2 Dual Ethernet Ports
- 6 Single Ethernet Port
- 8 Dual Ethernet Ports

Others

- H High Resolution
- T Wide Temperature
- P Projected Capacitive Touch (PCAP)



Advanced Model

Specifications



Model		cMT3072X2	cMT3072XH2	cMT3072XH2	cMT3072XP	cMT3092X
Display	Display	7" TFT	7" WVA	7" WVA	7" WVA	9.7" WVA
	Resolution	800 x 480	1024 x 600	1024 x 600	1024 x 600	1024 x 768
	Brightness (cd/ m ²)	400	450	450	450	350
	Contrast Ratio	800: 1	800: 1	800: 1	800: 1	900:1
	Backlight Type	LED	LED	LED	LED	LED
	Backlight Life Time	> 30,000 hrs.	> 30,000 hrs.	> 30,000 hrs.	> 30,000 hrs.	> 30,000 hrs.
	Colors	16.7M	16.7M	16.7M	16.7M	16.2M
	LCD Viewing Angle (T/B/L/R)	80/60/80/80	85/85/85/85	85/85/85/85	85/85/85/85	89/89/89/89
	Pixel Pitch (mm)	0.1926(H) x 0.179(V)	0.1506(H) x 0.1432(V)	0.1506(H) x 0.1432(V)	0.1506(H) x 0.1432(V)	0.192(H) x 0.192(V)
Touch Panel	Type	4-wire Resistive Type	4-wire Resistive Type	4-wire Resistive Type	Tempered Glass, Capacitive Type	4-wire Resistive Type
	Accuracy	Active Area Length(X)±2%, Width(Y)±2%	Active Area Length(X)±2%, Width(Y)±2%	Active Area Length(X)±2%, Width(Y)±2%	N/A	Active Area Length(X)±2%, Width(Y)±2%
Memory	Flash	4 GB	4 GB	4 GB	4 GB	4 GB
	RAM	1 GB	1 GB	1 GB	1 GB	1 GB
Processor		Quad-core RISC	Quad-core RISC	Quad-core RISC	Quad-core RISC	Quad-core RISC
I/O Port	USB Host	USB 2.0 x 1	USB 2.0 x 1	USB 2.0 x 1	USB 2.0 x 1	USB 2.0 x 1
	Ethernet	LAN 1: 10/100 Base-T x 1 LAN 2: 10/100 Base-T x 1	LAN 1: 10/100 Base-T x 1 LAN 2: 10/100 Base-T x 1	LAN 1: 10/100 Base-T x 1 LAN 2: 10/100 Base-T x 1	LAN 1: 10/100 Base-T x 1 LAN 2: 10/100 Base-T x 1	LAN 1: 10/100/1000 Base-T x 1 LAN 2: 10/100 Base-T x 1
	COM Port	Con.A: COM2 RS-485 2W/4W, COM3 RS-485 2W Con.B: COM1 RS-232 4W, COM3 RS-232 2W*	Con.A: COM2 RS-485 2W/4W, COM3 RS-485 2W, CAN Bus Con.B: COM1 RS-232 4W, COM3 RS-232 2W*	Con.A: COM2 RS-485 2W/4W, COM3 RS-485 2W, CAN Bus Con.B: COM1 RS-232 4W, COM3 RS-232 2W*	Con.A: COM2 RS-485 2W/4W, COM3 RS-485 2W, CAN Bus Con.B: COM1 RS-232 4W, COM3 RS-232 2W*	Con.A: COM2 RS-485 2W/4W, COM3 RS-485 2W Con.B: COM1 RS-232 4W, COM3 RS-232 2W*
	CAN Bus	N/A	Yes	Yes	Yes	N/A
	Audio Output	N/A	N/A	N/A	N/A	Built-in Mono Speaker
RTC		Built-in	Built-in	Built-in	Built-in	Built-in
Power	Input Power	24±20%VDC	24±20%VDC	24±20%VDC	24±20%VDC	24±20%VDC
	Power Isolation	Built-in	Built-in	Built-in	Built-in	Built-in
	Power Consumption	820mA@24VDC	820mA@24VDC	820mA@24VDC	820mA@24VDC	1A@24VDC
	Voltage Resistance	500VAC (1 min.)	500VAC (1 min.)	500VAC (1 min.)	500VAC (1 min.)	500VAC (1 min.)
	Isolation Resistance	Exceed 50MΩ @ 500VDC	Exceed 50MΩ @ 500VDC	Exceed 50MΩ @ 500VDC	Exceed 50MΩ @ 500VDC	Exceed 50MΩ @ 500VDC
Specification	PCB Coating	Yes	Yes	Yes	Yes	Yes
	Enclosure	Plastic	Plastic	Aluminum	Plastic	Plastic
	Dimensions WxHxD	200.3 x 146.3 x 35.0 mm	200.3 x 146.3 x 35.0 mm	200.4 x 146.5 x 36.0 mm	200.3 x 146.3 x 36.9 mm	260.6 x 203.1 x 44.5 mm
	Panel Cutout	192 x 138 mm	192 x 138 mm	192 x 138 mm	192 x 138 mm	250 x 192 mm
	Weight	Approx. 0.6 kg	Approx. 0.6 kg	Approx. 0.8 kg	Approx. 0.7 kg	Approx. 1 kg
	Mount	Panel mount	Panel mount	Panel mount	Panel mount	Panel mount, VESA mount 75 x 75 mm
Environment	Protection Structure	UL Type 4X (indoor use only) / NEMA4 / IP66 Compliant Front Panel	UL Type 4X (indoor use only) / NEMA4 / IP66 Compliant Front Panel	UL Type 4X (indoor use only) / NEMA4 / IP66 Compliant Front Panel	NEMA4 / IP66 Compliant Front Panel	UL Type 4X (indoor use only) / NEMA4 / IP66 Compliant Front Panel
	Storage Temperature	-20° ~ 60° C (-4° ~ 140° F)	-20° ~ 60° C (-4° ~ 140° F)	-20° ~ 60° C (-4° ~ 140° F)	-20° ~ 60° C (-4° ~ 140° F)	-20° ~ 60° C (-4° ~ 140° F)
	Operating Temperature	0° ~ 55° C (32° ~ 131° F)	0° ~ 55° C (32° ~ 131° F)	-20° ~ 55° C (-4° ~ 131° F)	0° ~ 55° C (32° ~ 131° F)	0° ~ 50° C (32° ~ 122° F)
	Relative Humidity	10% ~ 90% (non-condensing)	10% ~ 90% (non-condensing)	10% ~ 90% (non-condensing)	10% ~ 90% (non-condensing)	10% ~ 90% (non-condensing)
	Vibration Endurance	10 to 25Hz (X, Y, Z direction 2G 30 minutes)	10 to 25Hz (X, Y, Z direction 2G 30 minutes)	10 to 25Hz (X, Y, Z direction 2G 30 minutes)	10 to 25Hz (X, Y, Z direction 2G 30 minutes)	10 to 25Hz (X, Y, Z direction 2G 30 minutes)
Certificate	CE	CE marked	CE marked	CE marked	CE marked	CE marked
	UL	cULus Listed	cULus Listed	cULus Listed	cULus Listed	cULus Listed
Software	Weincloud	EasyAccess 2.0 (Optional) Dashboard (Optional)	EasyAccess 2.0 (Optional) Dashboard (Optional)	EasyAccess 2.0 (Optional) Dashboard (Optional)	EasyAccess 2.0 (Optional) Dashboard (Optional)	EasyAccess 2.0 (Optional) Dashboard (Optional)
	CODESYS	Optional	Optional	Optional	Optional	Optional

*Only Tx & Rx (no RTS/CTS) may be used for COM1 RS-232 when COM3 RS-232 is also used.



Capacitive Type



Wide Viewing Angle

Advanced Model

Dimensions

cMT3072X2	cMT3072XH2	cMT3072XHT	cMT3072XP	cMT3092X
-----------	------------	------------	-----------	----------

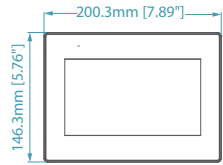

Front View

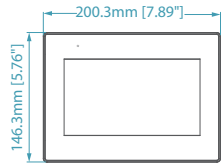

Front View

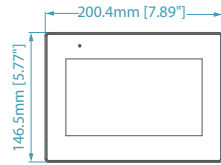

Front View

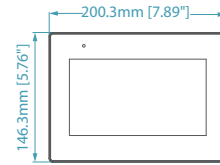

Front View

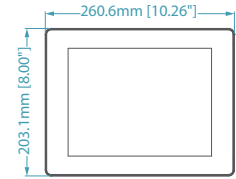

Front View

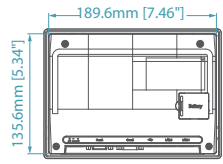

Rear View

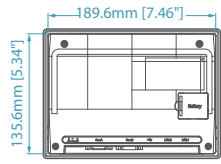

Rear View

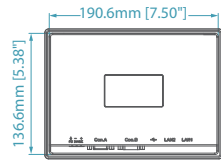

Rear View

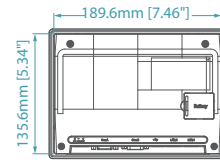

Rear View

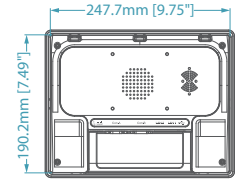

Rear View

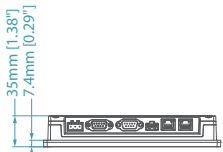

Bottom View

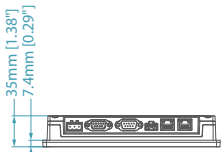

Bottom View



Bottom View

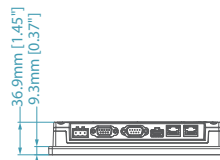

Bottom View

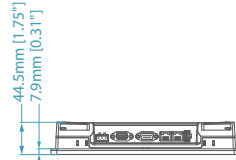

Bottom View

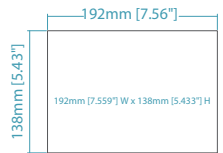

Cutout Dimensions

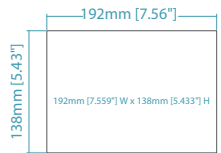

Cutout Dimensions

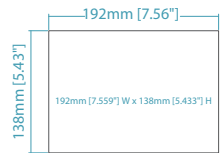

Cutout Dimensions

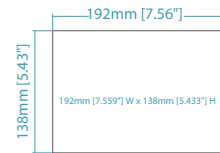

Cutout Dimensions

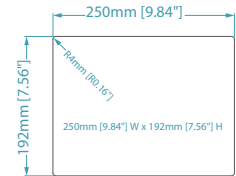

Cutout Dimensions

Advanced Model

Specifications



Model		cMT3108XH	cMT3108XP	cMT3102X	cMT3152X	cMT3162X	
Display	Display	10.1" WVA	10.1" WVA	10.1" WVA	15" WVA	15.6" WVA	
	Resolution	1280 x 800	1280 x 800	1024 x 600	1024 x 768	1920 x 1080	
	Brightness (cd/ m')	500	425	350	350	300	
	Contrast Ratio	800:1	800:1	1000:1	2500: 1	800: 1	
	Backlight Type	LED	LED	LED	LED	LED	
	Backlight Life Time	> 50,000 hrs.	> 50,000 hrs.	> 50,000 hrs.	> 70,000 hrs.	> 30,000 hrs.	
	Colors	16.7M	16.7M	16.7M	16.2M	16.2M	
	LCD Viewing Angle (T/B/L/R)	89/89/89/89	89/89/89/89	89/89/89/89	88/88/88/88	89/89/89/89	
	Pixel Pitch (mm)	0.1695 (H) x 0.1695 (V)	0.1695 (H) x 0.1695 (V)	0.2175 (H) x 0.2088 (V)	0.297(H) x 0.297(V)	0.17925(H) x 0.17925(V)	
	Touch Panel	Type	4-wire Resistive Type	Tempered Glass, Capacitive Type Hardness Scale 7H	4-wire Resistive Type	Tempered Glass, Capacitive Type Hardness Scale 7H	Tempered Glass, Capacitive Type Hardness Scale 7H
Accuracy		Active Area Length(X)±2%, Width(Y)±2%	N/A	Active Area Length(X)±2%, Width(Y)±2%	N/A	N/A	
Memory	Flash	4 GB	4 GB	4 GB	4 GB	4 GB	
	RAM	1 GB	1 GB	1 GB	1 GB	1 GB	
Processor		Quad-core RISC	Quad-core RISC	Quad-core RISC	Quad-core RISC	Quad-core RISC	
I/O Port	SD Card Slot	N/A	N/A	N/A	SD/SDHC	N/A	
	USB Host	USB 2.0 x 1	USB 2.0 x 1	USB 2.0 x 1	USB 2.0 x 1	USB 2.0 x 1	
	Ethernet	LAN 1: 10/100/1000 Base-T x 1 LAN 2: 10/100 Base-T x 1	LAN 1: 10/100/1000 Base-T x 1 LAN 2: 10/100 Base-T x 1	LAN 1: 10/100/1000 Base-T x 1 LAN 2: 10/100 Base-T x 1	LAN 1: 10/100/1000 Base-T x 1 LAN 2: 10/100 Base-T x 1	LAN 1: 10/100/1000 Base-T x 1 LAN 2: 10/100 Base-T x 1	LAN 1: 10/100/1000 Base-T x 1 LAN 2: 10/100 Base-T x 1
		WiFi	M02 WiFi Expansion Module (Optional)	M02 WiFi Expansion Module (Optional)	M02 WiFi Expansion Module (Optional)	N/A	N/A
	COM Port	Con.A: COM2 RS-485 2W/4W, COM3 RS-485 2W, CAN Bus Con.B: COM1 RS-232 4W, COM3 RS-232 2W*	Con.A:COM2 RS-485 2W/4W, COM3 RS-485 2W,CAN Bus Con.B: COM1 RS-232 4W, COM3 RS-232 2W*	Con.A: COM2 RS-485 2W/4W, COM3 RS-485 2W, CAN Bus Con.B: COM1 RS-232 4W, COM3 RS-232 2W*	Con.A: COM1 RS-485 2W/4W, COM3 RS-485 2W Con.B: COM1 RS-232 4W, COM3 RS-232 2W*	Con.A: COM1 RS-485 2W/4W, COM3 RS-485 2W Con.B: COM1 RS-232 4W, COM3 RS-232 2W*	Con.A: COM1 RS-485 2W/4W, COM3 RS-485 2W, CAN Bus Con.B: COM1 RS-232 4W, COM3 RS-232 2W*
		CAN Bus	Yes	Yes	Yes	N/A	Yes
	Audio Output	Built-in Mono Speaker	Built-in Mono Speaker	N/A	Built-in Mono Speaker Audio Line Out - 3.5 mm jack x 1	Built-in Mono Speaker	
	RTC		Built-in	Built-in	Built-in	Built-in	Built-in
	Power	Input Power	24±20%VDC	24±20%VDC	24±20%VDC	24±20%VDC	24±20%VDC
		Power Isolation	Built-in	Built-in	Built-in	Built-in	Built-in
Power Consumption		700mA@24VDC	700mA@24VDC	1A@24VDC	1.3A@24VDC	1.3A@24VDC	
Voltage Resistance		500VAC (1 min.)	500VAC (1 min.)	500VAC (1 min.)	500VAC (1 min.)	500VAC (1 min.)	
Isolation Resistance		Exceed 50MΩ @ 500VDC	Exceed 50MΩ @ 500VDC	Exceed 50MΩ @ 500VDC	Exceed 50MΩ @ 500VDC	Exceed 50MΩ @ 500VDC	
Specification	PCB Coating	Yes	Yes	Yes	Yes	Yes	
	Enclosure	Plastic	Plastic	Plastic	Front bezel: Plastic, Rear Enclosure: Aluminum	Front bezel: Plastic, Rear Enclosure: Aluminum	
	Dimensions WxHxD	266 x 196 x 40 mm	266 x 196 x 42.7 mm	271 x 213 x 38 mm	366 x 293 x 51.5 mm	400 x 263 x 27.6 mm	
	Panel Cutout	255 x 185 mm	255 x 185 mm	260 x 202 mm	352 x 279 mm	384 x 247 mm	
	Weight	Approx. 1.1 kg	Approx. 1.1 kg	Approx. 1.2 kg	Approx. 2.85 kg	Approx. 1.6 kg	
	Mount	Panel mount, VESA mount 75 x 75 mm	Panel mount, VESA mount 75 x 75 mm	Panel mount, VESA mount 75 x 75 mm	Panel mount, VESA mount 75 x 75 mm	Panel mount, VESA mount 100 x 100 mm	
Environment	Protection Structure	UL Type 4X (indoor use only) / NEMA4 / IP66 Compliant Front Panel	UL Type 4X (indoor use only) / NEMA4 / IP66 Compliant Front Panel	UL Type 4X (indoor use only) / NEMA4 / IP66 Compliant Front Panel	NEMA4 / IP66 Compliant Front Panel	NEMA4 / IP66 Compliant Front Panel	
	Storage Temperature	-20° ~ 60° C (-4° ~ 140° F)	-20° ~ 60° C (-4° ~ 140° F)	-20° ~ 60° C (-4° ~ 140° F)	-20° ~ 60° C (-4° ~ 140° F)	-20° ~ 60° C (-4° ~ 140° F)	
	Operating Temperature	0° ~ 55° C (32° ~ 131° F)	0° ~ 55° C (32° ~ 131° F)	0° ~ 50° C (32° ~ 122° F)	0° ~ 50° C (32° ~ 122° F)	0° ~ 50° C (32° ~ 122° F)	
	Relative Humidity	10% ~ 90% (non-condensing)	10% ~ 90% (non-condensing)	10% ~ 90% (non-condensing)	10% ~ 90% (non-condensing)	10% ~ 90% (non-condensing)	
	Vibration Endurance	10 to 25Hz (X, Y, Z direction 2G 30 minutes)	10 to 25Hz (X, Y, Z direction 2G 30 minutes)	10 to 25Hz (X, Y, Z direction 2G 30 minutes)	10 to 25Hz (X, Y, Z direction 2G 30 minutes)	10 to 25Hz (X, Y, Z direction 2G 30 minutes)	
Certificate	CE	CE marked	CE marked	CE marked	CE marked	CE marked	
	UL	cULus Listed	cULus Listed	cULus Listed	cULus Listed	cULus Listed	
	ATEX	ATEX Zone 2/22 Category 3 G/D	ATEX Zone 2/22 Category 3 G/D	ATEX Zone 2/22 Category 3 G/D	N/A	N/A	
Software	Weincloud	EasyAccess 2.0 (Optional) Dashboard (Optional)	EasyAccess 2.0 (Optional) Dashboard (Optional)	EasyAccess 2.0 (Optional) Dashboard (Optional)	EasyAccess 2.0 (Optional) Dashboard (Optional)	EasyAccess 2.0 (Optional) Dashboard (Optional)	
	CODESYS	Optional	Optional	Optional	Optional	Optional	

*Only Tx & Rx (no RTS/CTS) may be used for COM1 RS-232 when COM3 RS-232 is also used.



Vibration Alert



Capacitive Type



Wide Viewing Angle

Advanced Model

Dimensions

cMT3108XH	cMT3108XP	cMT3102X	cMT3152X	cMT3162X
-----------	-----------	----------	----------	----------

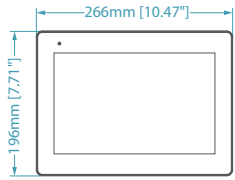

Front View

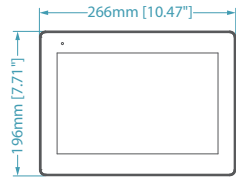

Front View

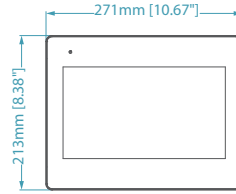

Front View

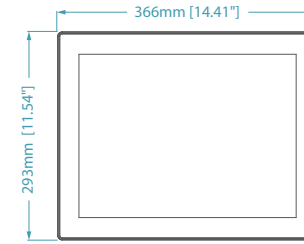

Front View

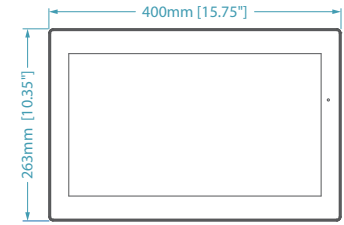

Front View

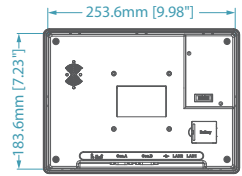

Rear View

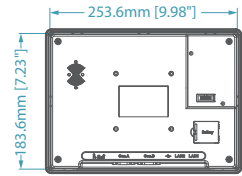

Rear View

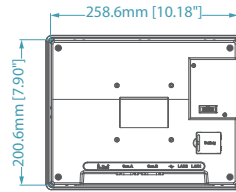

Rear View

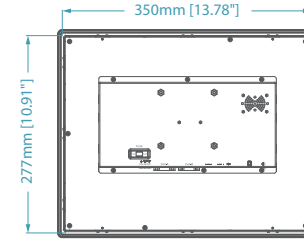

Rear View

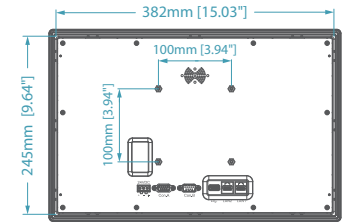

Rear View

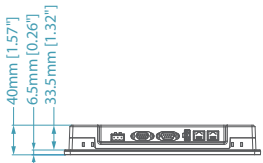

Bottom View

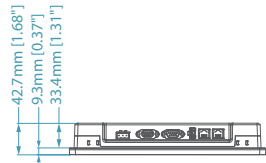

Bottom View

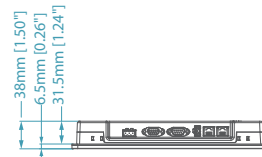

Bottom View

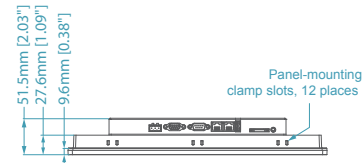

Bottom View

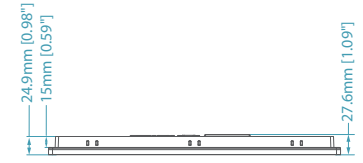

Bottom View

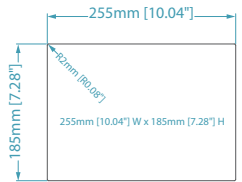

Cutout Dimensions

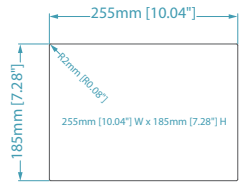

Cutout Dimensions

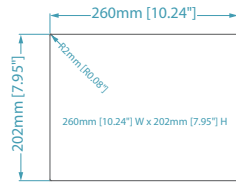

Cutout Dimensions

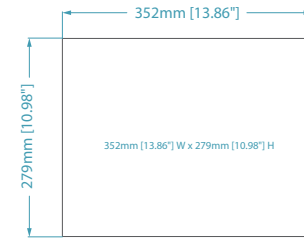

Cutout Dimensions

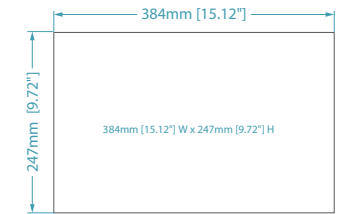

Cutout Dimensions

Standard Model

Specifications



Model		cMT2058XH	cMT2078X	cMT2108X2	cMT2128X	cMT2158X	cMT2166X	
Display	Display	4.3" WVA	7" TFT	10.1" WVA	12.1" WVA	15" WVA	15.6" WVA	
	Resolution	800 x 480	800 x 480	1024 x 600	1024 x 768	1024 x 768	1920 x 1080	
	Brightness (cd / m ²)	530	400	350	500	350	300	
	Contrast Ratio	800: 1	800: 1	1000:1	1000:1	2500: 1	800: 1	
	Backlight Type	LED	LED	LED	LED	LED	LED	
	Backlight Life Time	>30,000 hrs.	>30,000 hrs.	>50,000 hrs.	>30,000 hrs.	>70,000 hrs.	>30,000 hrs.	
	Colors	16.7M	16.7M	16.7M	16.7M	16.2M	16.2M	
	LCD Viewing Angle (T/B/L/R)	80/80/80/80	80/60/80/80	89/89/89/89	89/89/89/89	88/88/88/88	89/89/89/89	
Pixel Pitch (mm)	0.1188 (H) x 0.1122 (V)	0.1926(H) x 0.179(V)	0.2175 (H) x 0.2088 (V)	0.240 (H) x 0.240 (V)	0.297(H) x 0.297(V)	0.17925(H) x 0.17925(V)		
Touch Panel	Type	4-wire Resistive Type	4-wire Resistive Type	4-wire Resistive Type	4-wire Resistive Type	4-wire Resistive Type	Tempered Glass, Capacitive Type	
	Accuracy	Active Area Length(X)±2%, Width(Y)±2%	Active Area Length(X)±2%, Width(Y)±2%	Active Area Length(X)±2%, Width(Y)±2%	Active Area Length(X)±2%, Width(Y)±2%	Active Area Length(X)±2%, Width(Y)±2%	N/A	
Memory	Flash	4 GB	4 GB	4 GB	4 GB	4 GB	4 GB	
	RAM	512 MB	1 GB	1 GB	1 GB	1 GB	1 GB	
Processor		Quad-core RISC	Quad-core RISC	Quad-core RISC	Quad-core RISC	Quad-core RISC	Quad-core RISC	
I/O Port	SD Card Slot	N/A	N/A	N/A	Micro SD x 1	SD/SDHC	N/A	
	USB Host	USB 2.0 x 1	USB 2.0 x 1	USB 2.0 x 1	USB 2.0 x 1	USB 2.0 x 1	USB 2.0 x 1	
	Ethernet	LAN 1: 10/100/1000 Base-T x 1	LAN 1: 10/100 Base-T x 1	LAN 1: 10/100 Base-T x 1	LAN 1: 10/100/1000 Base-T x 1	LAN 1: 10/100/1000 Base-T x 1	LAN 1: 10/100/1000 Base-T x 1	10/100 Base-T x 1
		LAN 2: 10/100 Base-T x 1	LAN 2: 10/100 Base-T x 1	LAN 2: 10/100 Base-T x 1	LAN 2: 10/100 Base-T x 1	LAN 2: 10/100 Base-T x 1	LAN 2: 10/100 Base-T x 1	
	WiFi	N/A	N/A	M02 WiFi Expansion Module (Optional)	N/A	N/A	N/A	
	COM Port	COM1: RS-232/RS-485 2W/4W, COM3 RS-485 2W	Con.A: COM2 RS-485 2W/4W, COM3 RS-485 2W	Con.A: COM2 RS-485 2W/4W, COM3 RS-485 2W	Con.A: COM2 RS-485 2W/4W, COM3 RS-485 2W	Con.A: COM2 RS-485 2W/4W, COM3 RS-485 2W	Con.A: COM1 RS-485 2W/4W, COM3 RS-485 2W	Con.A: COM1 RS-485 2W/4W, COM3 RS-485 2W
		COM2: RS-232 4W, COM3 RS-232 2W*	Con.B: COM1 RS-232 4W, COM3 RS-232 2W*	Con.B: COM1 RS-232 4W, COM3 RS-232 2W*	Con.B: COM1 RS-232 4W, COM3 RS-232 2W*	Con.B: COM1 RS-232 4W, COM3 RS-232 2W*	Con.B: COM1 RS-232 4W, COM3 RS-232 2W*	Con.B: COM1 RS-232 4W, COM3 RS-232 2W*
RS-485 Dual Isolation	N/A	N/A	N/A	Yes	N/A	N/A		
Audio Output	N/A	N/A	N/A	N/A	Built-in Mono Speaker Audio Line Out - 3.5 mm jack x 1	Built-in Mono Speaker		
RTC		Built-in	Built-in	Built-in	Built-in	Built-in	Built-in	
Power	Input Power	24±20%VDC	24±20%VDC	24±20%VDC	24±20%VDC	24±20%VDC	24±20%VDC	
	Power Isolation	Built-in	Built-in	Built-in	Built-in	Built-in	Built-in	
	Power Consumption	510mA@24VDC	820mA@24VDC	1A@24VDC	1.2A@24VDC	1.3A@24VDC	0.9A@24VDC	
	Voltage Resistance	500VAC (1 min.)	500VAC (1 min.)	500VAC (1 min.)	500VAC (1 min.)	500VAC (1 min.)	500VAC (1 min.)	
	Isolation Resistance	Exceed 50MΩ @ 500VDC	Exceed 50MΩ @ 500VDC	Exceed 50MΩ @ 500VDC	Exceed 50MΩ @ 500VDC	Exceed 50MΩ @ 500VDC	Exceed 50MΩ @ 500VDC	
Specification	PCB Coating	Yes	Yes	Yes	Yes	Yes	Yes	
	Enclosure	Plastic	Plastic	Plastic	Plastic	Aluminum	Front bezel: Plastic, Rear Enclosure: Aluminum	
	Dimensions WxHxD	128 x 102 x 32 mm	200.3 x 146.3 x 35.0 mm	271 x 213 x 38 mm	317 x 243 x 41 mm	366 x 293 x 48.2mm	400 x 263 x 27.6 mm	
	Panel Cutout	119 x 93 mm	192 x 138 mm	260 x 202 mm	305 x 231 mm	352 x 279 mm	384 x 247 mm	
	Weight	Approx. 0.27 kg	Approx. 0.6 kg	Approx. 1.2 kg	Approx. 1.7 kg	Approx. 2.74 kg	Approx. 1.6 kg	
	Mount	Panel mount	Panel mount	Panel mount, VESA mount 75 x 75 mm	Panel mount, VESA mount 75 x 75 mm	Panel mount, VESA mount 75 x 75 mm	Panel mount, VESA mount 100 x 100 mm	
Environment	Protection Structure	NEMA4 / IP66 Compliant Front Panel	UL Type 4X (indoor use only) / NEMA4 / IP66 Compliant Front Panel	UL Type 4X (indoor use only) / NEMA4 / IP66 Compliant Front Panel	UL Type 4X (indoor use only) / NEMA4 / IP66 Compliant Front Panel	UL Type 4X (indoor use only) / NEMA4 / IP66 Compliant Front Panel	NEMA4 / IP66 Compliant Front Panel	
	Storage Temperature	-20° ~ 60° C (-4° ~ 140° F)	-20° ~ 60° C (-4° ~ 140° F)	-20° ~ 60° C (-4° ~ 140° F)	-20° ~ 60° C (-4° ~ 140° F)	-20° ~ 60° C (-4° ~ 140° F)	-20° ~ 60° C (-4° ~ 140° F)	
	Operating Temperature	0° ~ 50° C (32° ~ 122° F)	0° ~ 55° C (32° ~ 131° F)	0° ~ 50° C (32° ~ 122° F)	0° ~ 55° C (32° ~ 131° F)	0° ~ 50° C (32° ~ 122° F)	0° ~ 50° C (32° ~ 122° F)	
	Relative Humidity	10% ~ 90% (non-condensing)	10% ~ 90% (non-condensing)	10% ~ 90% (non-condensing)	10% ~ 90% (non-condensing)	10% ~ 90% (non-condensing)	10% ~ 90% (non-condensing)	
Vibration Endurance	10 to 25Hz (X, Y, Z direction 2G 30 minutes)	10 to 25Hz (X, Y, Z direction 2G 30 minutes)	10 to 25Hz (X, Y, Z direction 2G 30 minutes)	10 to 25Hz (X, Y, Z direction 2G 30 minutes)	10 to 25Hz (X, Y, Z direction 2G 30 minutes)	10 to 25Hz (X, Y, Z direction 2G 30 minutes)		
Certificate	CE	CE marked	CE marked	CE marked	CE marked	CE marked	CE marked	
	UL	cULus Listed	cULus Listed	cULus Listed	cULus Listed	cULus Listed	cULus Listed	
Software	Weincloud	EasyAccess 2.0 (Optional) Dashboard (Optional)	EasyAccess 2.0 (Optional) Dashboard (Optional)	EasyAccess 2.0 (Optional) Dashboard (Optional)	EasyAccess 2.0 (Optional) Dashboard (Optional)	EasyAccess 2.0 (Optional) Dashboard (Optional)	EasyAccess 2.0 (Optional) Dashboard (Optional)	
	CODESYS	Optional	Optional	Optional	Optional	Optional	N/A	

*Only Tx & Rx (no RTS/CTS) may be used for COM1 RS-232 when COM3 RS-232 is also used.

*The cMT2108X2 (V2) / cMT2158X (V2) product label indicates MPI support, while the original cMT2108X2 / cMT2158X label does not.



Capacitive Type



Wide Viewing Angle

Standard Model

Dimensions

cMT2058XH	cMT2078X	cMT2108X2	cMT2128X	cMT2158X	cMT2166X
-----------	----------	-----------	----------	----------	----------

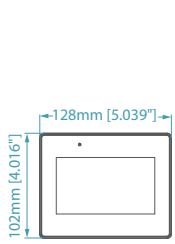

Front View

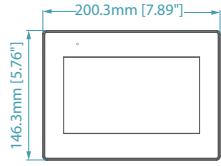

Front View

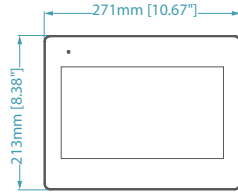

Front View

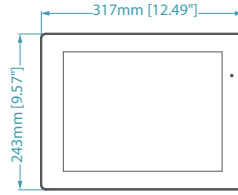

Front View

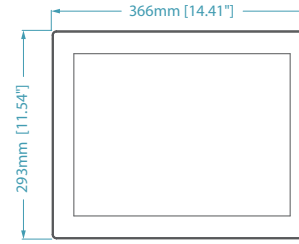

Front View

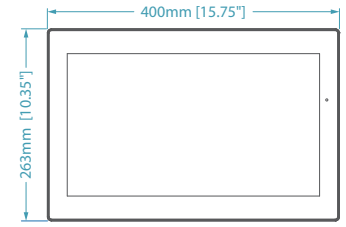

Front View

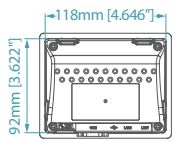

Rear View

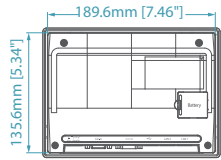

Rear View

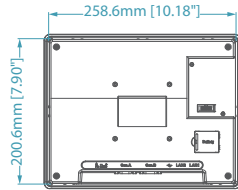

Rear View

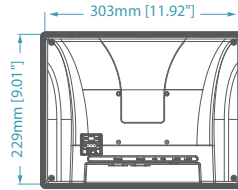

Rear View

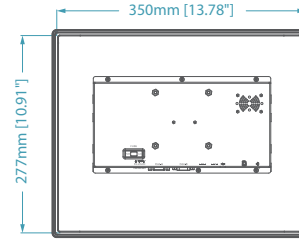

Rear View

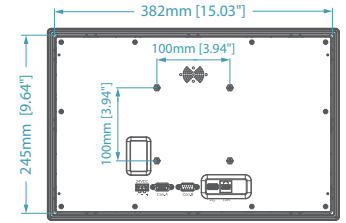

Rear View

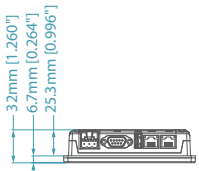

Bottom View

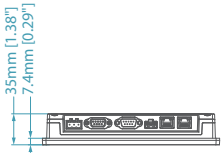

Bottom View

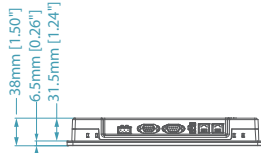

Bottom View

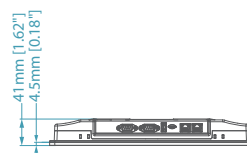

Bottom View

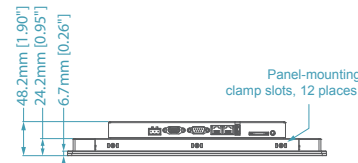

Bottom View

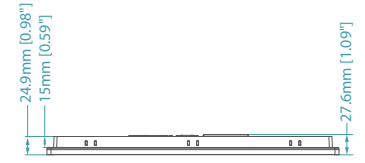

Bottom View

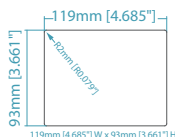

Cutout Dimensions

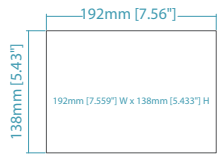

Cutout Dimensions

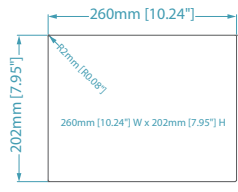

Cutout Dimensions

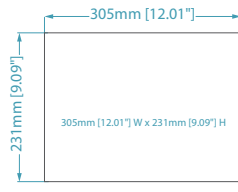

Cutout Dimensions

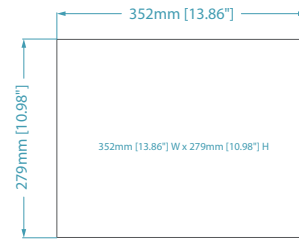

Cutout Dimensions

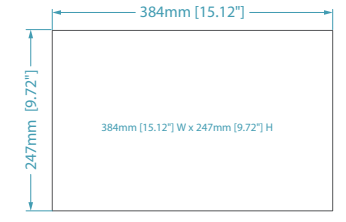

Cutout Dimensions

Basic Model

Specifications & Dimensions



Model		cMT1106X
Display	Display	10.1" WVA
	Resolution	1024 x 600
	Brightness (cd/ m')	350
	Contrast Ratio	1000 :1
	Backlight Type	LED
	Backlight Life Time	> 50,000 hrs.
	Colors	16.7M
	LCD Viewing Angle (T/B/L/R)	89/89/89/89
	Pixel Pitch (mm)	0.2175 (H) x 0.2088 (V)
	Touch Panel	Type
Accuracy		Active Area Length(X)±2%, Width(Y)±2%
Memory	Flash	4 GB
	RAM	1 GB
Processor		Quad-core RISC
I/O Port	USB Host	USB 2.0 x 1
	Ethernet	10/100 Base-T x 1
	WiFi	M02 WiFi Expansion Module (Optional)
COM Port		Con.A: COM2 RS-485 2W/4W, COM3 RS-485 2W
		Con.B: COM1 RS-232 4W, COM3 RS-232 2W*
RTC		Built-in
Power	Input Power	24±20%VDC
	Power Isolation	Built-in
	Power Consumption	720mA@24VDC
	Voltage Resistance	500VAC (1 min.)
	Isolation Resistance	Exceed 50MΩ @ 500VDC
Specification	PCB Coating	Yes
	Enclosure	Plastic
	Dimensions WxHxD	271 x 213 x 38 mm
	Panel Cutout	260 x 202 mm
	Weight	Approx. 1.2 kg
	Mount	Panel mount, VESA mount 75 x 75 mm
Environment	Protection Structure	NEMA4 / IP66 Compliant Front Panel
	Storage Temperature	-20° ~ 60° C (-4° ~ 140° F)
	Operating Temperature	0° ~ 50° C (32° ~ 122° F)
	Relative Humidity	10% ~ 90% (non-condensing)
	Vibration Endurance	10 to 25Hz (X, Y, Z direction 2G 30 minutes)
Certificate	CE	CE marked
Software	Weincloud	EasyAccess 2.0 (Optional) Dashboard (Optional)
	CODESYS	N/A

*Only Tx & Rx (no RTS/CTS) may be used for COM1 RS-232 when COM3 RS-232 is also used.

cMT1106X

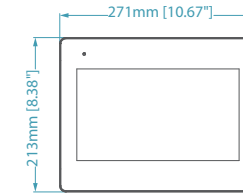

Front View

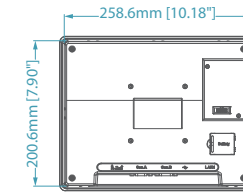

Rear View

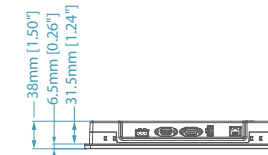

Bottom View

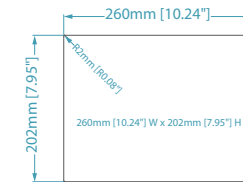

Cutout Dimensions

Accessories

Specifications & Dimensions



Model		M02
Network	WiFi	IEEE 802.11 b/g/n 802.11b: max 19.76 dBm 802.11g: max 19.93 dBm 802.11n: max 19.99 dBm
I/O Port	SMA Female Connector	1
	Male Connector to HMI	1
Power	Input Power	5VDC
	Power Consumption	900mA@5VDC (powered by HMI)
	Voltage Resistance	500VAC (1min.)
	Isolation Resistance	Exceed 50MΩ @ 500VDC
Specification	PCB Coating	N/A
	Enclosure	Plastic
	Dimensions WxHxD	54.5 x 80 x 24.1 mm
	Weight	Approx. 80 g
	Mount	HMI connector + diagonal screw fastening
	Environment	Protection Structure
	Storage Temperature	-20° ~ 60° C (-4° ~ 140° F)
	Operating Temperature	0° ~ 55° C (32° ~ 131° F)
	Relative Humidity	10% ~ 90% (non-condensing)
	Vibration Endurance	10 to 25Hz (X, Y, Z direction 2G 30 minutes)
Certificate	CE	CE marked
	UL	cULus Listed

M02

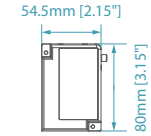

Front View

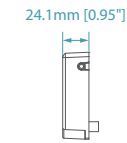

Side View

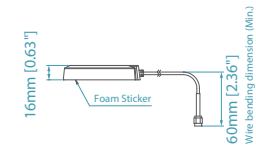
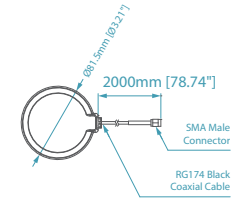

Antenna

Headless HMI

Specifications & Dimensions



Model		cMT-FHDX-820	cMT-SVRX-820 / 822
Memory	Flash	4 GB	4 GB
	RAM	1 GB	1 GB
Processor		Quad-core RISC	Quad-core RISC
I/O Port	SD Card Slot	N/A	Micro SD x1
	USB Host	USB 2.0 x 1	USB 2.0 x 1
	Ethernet	LAN 1: 10/100/1000 Base-T x 1 LAN 2: 10/100 Base-T x 1	LAN 1: 10/100/1000 Base-T x 1 LAN 2: 10/100 Base-T x 1
	COM Port	COM1: RS-232 2W COM2: RS-485 2W/4W COM3: RS-485 2W	COM1: RS-232 2W COM2: RS-485 2W/4W COM3: RS-485 2W
	HDMI	Customizable (max. resolution 1920 x 1080)	N/A
Recommended Resolutions (Please use these recommended screen resolutions to avoid compatibility issues.)		720x480 / 720x576 / 800x600 1024x768 / 1280x720 1366x768 / 1920x1080	N/A
Audio Output		HDMI Audio Output	N/A
RTC		Built-in	Built-in
Power	Input Power	24±20%VDC	24±20%VDC
	Power Isolation	Built-in	Built-in
	Power Consumption	850mA@24VDC	850mA@24VDC
	Voltage Resistance	500VAC (1 min.)	500VAC (1 min.)
Isolation Resistance		Exceed 50MΩ @ 500VDC	Exceed 50MΩ @ 500VDC
Specification	PCB Coating	Yes	Yes
	Enclosure	Plastic	Plastic
	Dimensions WxHxD	29.8 x 130 x 115 mm	29.8 x 130 x 115 mm
	Weight	Approx. 0.24 kg	Approx. 0.24 kg
Mount		35 mm DIN rail mounting	35 mm DIN rail mounting
Environment	Protection Structure	IP20	IP20
	Storage Temperature	-20° ~ 60° C (-4° ~ 140° F)	-20° ~ 60° C (-4° ~ 140° F)
	Operating Temperature	0° ~ 50° C (32° ~ 122° F)	0° ~ 50° C (32° ~ 122° F)
	Relative Humidity	10% ~ 90% (non-condensing)	10% ~ 90% (non-condensing)
	Vibration Endurance	10 to 25Hz (X, Y, Z direction 2G 30 minutes)	10 to 25Hz (X, Y, Z direction 2G 30 minutes)
Certificate	CE	CE marked	CE marked
	UL	cULus Listed	cULus Listed
Software	Weincloud	EasyAccess 2.0 (Optional) Dashboard (Optional)	EasyAccess 2.0 (Optional) Dashboard (Optional)
	CODESYS	Optional	Optional

cMT-FHDX-820

cMT-SVRX-820 / 822

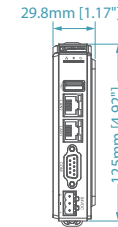

Front View

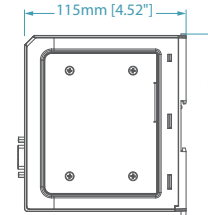

Side View



Top View



Bottom View

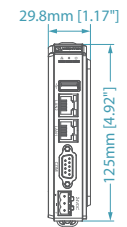

Front View

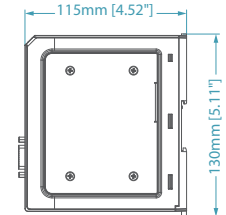

Side View



Top View







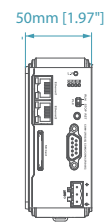

Bottom View

Other Model

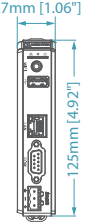
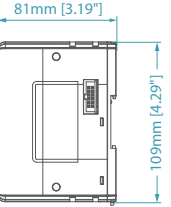
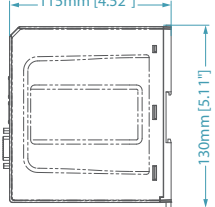
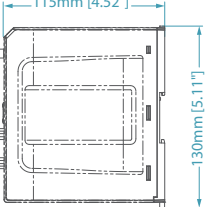
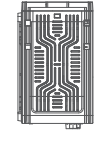
Specifications & Dimensions

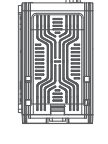
Model		cMT-CTRL01	cMT-SVR-100 / 102	cMT-SVR-200 / 202
Memory	Flash	4 GB	256 MB	256 MB
	RAM	512 MB	256 MB	256 MB
	Data, Memory, Code	3 MB	N/A	N/A
	Retain area	16 KB (every minute) (Kept after reboots)	N/A	N/A
	Persistent area	16 KB (every minute) (Kept after downloads)	N/A	N/A
	File system	8MB	N/A	N/A
Processor		Dual-Core 32 bits RISC 1GHz	32-bit RISC 600MHz	32-bit RISC 600MHz
I/O Port	SD Card Slot	SD/SDHC	SD/SDHC	SD/SDHC
	USB Host	N/A	USB 2.0 x 1	USB 2.0 x 1
	Ethernet	Ethernet 1: 10/100/1000 Base-T x 1 Ethernet 2: 10/100 Base-T x 1	10/100/1000 Base-T x 2	10/100/1000 Base-T x 1
	WiFi	N/A	N/A	IEEE 802.11 b/g/n 802.11b: max 18.01 dBm 802.11g: max 11.02 dBm 802.11n: max 12.20 dBm
	COM Port	COM1: RS-232 2W COM2: RS-485 2W/4W COM3: RS-485 2W	COM1: RS-232 COM2: RS-485 2W/4W COM3: RS-485 2W	COM1: RS-232 2W COM2: RS-485 2W/4W COM3: RS-485 2W
	Local bus	iBus	N/A	N/A
CODESYS	Protocol	Modbus TCP/IP Master, EtherCAT Master	N/A	N/A
RTC		Built-in	Built-in	Built-in
Power	Input Power	24±20%VDC	24±20%VDC	10.5~28VDC
	Power Isolation	Built-in	Built-in	Built-in
	Current for Internal Bus	Max 2A@5VDC	N/A	N/A
	Current Consumption	550mA@5VDC	N/A	N/A
	Power Consumption	Nominal 310mA@24VDC	230mA@24VDC	1A@12VDC ; 450mA@24VDC
	Voltage Resistance	500VAC (1 min.)	500VAC (1 min.)	500VAC (1 min.)
Isolation Resistance	Exceed 50MΩ @ 500VDC	Exceed 50MΩ @ 500VDC	Exceed 50MΩ @ 500VDC	
Specification	PCB Coating	Yes	Yes	Yes
	Enclosure	Plastic	Plastic	Plastic
	Dimensions WxHxD	50 x 109 x 81 mm	27 x 130 x 115 mm	27 x 130 x 115 mm
	Weight	Approx. 0.24 kg	Approx. 0.18 kg	Approx. 0.18 kg
Environment	Mount	35 mm DIN rail mounting	35 mm DIN rail mounting	35 mm DIN rail mounting
	Protection Structure	IP20	IP20	IP20
	Storage Temperature	-20° ~ 70° C (-4° ~ 158° F)	-20° ~ 70° C (-4° ~ 158° F)	-20° ~ 70° C (-4° ~ 158° F)
	Operating Temperature	-10° ~ 50° C (14° ~ 122° F)	-20° ~ 55° C (-4° ~ 131° F)	-10° ~ 55° C (14° ~ 131° F)
	Relative Humidity	10% ~ 90% (non-condensing)	10% ~ 90% (non-condensing)	10% ~ 90% (non-condensing)
	Vibration Endurance	10 to 25Hz (X, Y, Z direction 2G 30 minutes)	10 to 25Hz (X, Y, Z direction 2G 30 minutes)	10 to 25Hz (X, Y, Z direction 2G 30 minutes)
Certificate	CE	CE marked	CE marked	CE marked
	UL	cULus Listed	cULus Listed	cULus Listed
Software	Weincloud	EasyAccess 2.0 (Optional)	EasyAccess 2.0 (Optional)	EasyAccess 2.0 (Optional)
	CODESYS	Built-in	N/A	N/A

cMT-CTRL01	cMT-SVR-100 / 102	cMT-SVR-200 / 202
		
50mm [1.97"]	27mm [1.06"] 125mm [4.92"]	27mm [1.06"] 125mm [4.92"]
Front View	Front View	Front View
		
81mm [3.19"] 109mm [4.29"]	115mm [4.52"] 130mm [5.11"]	115mm [4.52"] 130mm [5.11"]
Side View	Side View	Side View
		
Top View	Top View	Top View
		
Bottom View	Bottom View	Bottom View

Communication Interface

iR Series Specifications



Model		iR-ETN	iR-COP	iR-ECAT
Expansion I/O Module	Number of Bus Terminals	Depends on Power Consumption	Depends on Power Consumption	Depends on Power Consumption
	Digital Input Point	Max. 256	Max. 256	Max. 256
	Digital Output Point	Max. 128	Max. 128	Max. 128
	Analog Input Channel	Max. 64	Max. 64	Max. 64
	Analog Output Channel	Max. 64	Max. 64	Max. 64
Data Transfer Rate	10/100 Mbps	50k~1 Mbps	100 Mbps	
Max. Number of TCP/IP Connections	8 Connections	-	-	
Protocol	Modbus TCP/IP Server, EtherNet/IP adapter	CANopen Slave	EtherCAT Slave	
Isolation	Network to Logic Isolation : Yes	CAN bus Isolation : Yes	Network to Logic Isolation : Yes	
Power	Power Supply	24 VDC (-15%/+20%)	24 VDC (-15%/+20%)	24 VDC (-15%/+20%)
	Power Consumption	Nominal 100mA@24VDC	Nominal 100mA@24VDC	Nominal 100mA @ 24VDC
	Current for Internal Bus	Max 2A@5VDC	Max 2A@5VDC	Max 2A@5VDC
	Current Consumption	220mA@5VDC	170mA@5VDC	270mA@5VDC
	Power Isolation	Yes	Yes	Yes
	Back-up Fuse	≤ 1.6A Self-recovery	≤ 1.6A Self-recovery	≤ 1.6A Self-recovery
	PCB Coating	Yes	Yes	Yes
Specification	Enclosure	Plastic	Plastic	Plastic
	Dimensions WxHxD	27 x 109 x 81 mm	27 x 109 x 81 mm	27 x 109 x 81 mm
	Weight	Approx. 0.15 kg	Approx. 0.15 kg	Approx. 0.15 kg
	Mount	35mm DIN rail mounting	35mm DIN rail mounting	35mm DIN rail mounting
Environment	Protection Structure	IP20	IP20	IP20
	Storage Temperature	-20° ~ 70° C (-4° ~ 158° F)	-20° ~ 70° C (-4° ~ 158° F)	-20° ~ 70° C (-4° ~ 158° F)
	Operating Temperature	0° ~ 55° C (32° ~ 131° F)	0° ~ 55° C (32° ~ 131° F)	0° ~ 55° C (32° ~ 131° F)
	Relative Humidity	10% ~ 90% (non-condensing)	10% ~ 90% (non-condensing)	10% ~ 90% (non-condensing)
Certification	EMC Immunity	Conforms to EN 55032: 2012+AC: 2013, Class A EN 61000-6-4: 2007+A1:2011 EN 55024: 2010+A1: 2015 EN 61000-6-2:2005	Conforms to EN 55032: 2012+AC: 2013, Class A EN 61000-6-4: 2007+A1:2011 EN 55024: 2010+A1: 2015 EN 61000-6-2:2005	Conforms to EN 55032: 2012+AC: 2013, Class A EN 61000-6-4: 2007+A1:2011 EN 55024: 2010+A1: 2015 EN 61000-6-2:2005
	UL	cULus Listed	cULus Listed	cULus Listed

Communication Interface

Specifications



	Model	iR-ETN40R	iR-ETN40P
Expansion I/O Module	No. of Bus Terminals	Depends on Power Consumption	Depends on Power Consumption
	Digital Input Point	Max. 224	Max. 224
	Digital Output Point	Max. 112	Max. 112
	Analog Input Channel	Max. 64	Max. 64
	Analog Output Channel	Max. 64	Max. 64
Communication Interface Specifications	Data Transfer Rate	10/100 Mbps	10/100 Mbps
	Max. Number of TCP/IP Connections	8 connections	8 connections
	Protocol	Modbus TCP Server, EtherNet/IP adapter	Modbus TCP Server, EtherNet/IP adapter
	Network to Logic Isolation	Yes	Yes
	No. of Ports	1	1
Digital Output	Total Number of Outputs	16	16
	Output Type	Relay	Source
	Output Voltage	250VAC/30VDC	11~28VDC
	Output Current	2A per channel (Max 8A)	0.5A per channel (Max 4A)
	Response Time	10 ms	OFF->ON: 100 μs, ON->OFF: 600 μs
High-speed Output	Isolation	Yes, electromagnetic isolation	Yes, optocoupler isolation
	Total Number of Outputs	0	2
	Output Type	N/A	Source
	Output Voltage	N/A	5VDC
	Output Current	N/A	50mA per channel
Digital Input	Max. Output Frequency	N/A	40KHz
	Isolation	N/A	Yes, optocoupler isolation
	Total Number of Inputs	24	24
	Isolation	Yes, optical isolation	Yes, optical isolation
	Total Number of Inputs	20	20
General Input	Input Type	Sink or Source	Sink or Source
	Logic 1 Input Voltage	15~28 VDC	15~28 VDC
	Logic 0 Input Voltage	0~5 VDC	0~5 VDC
	Response Time	OFF->ON: 5 ms, ON->OFF: 1 ms	OFF->ON: 5 ms, ON->OFF: 1 ms
	Total Number of Inputs	4	4
High-speed Input	Input Type	SINK INPUT (PNP)	SINK INPUT (PNP)
	Logic 1 Input Voltage	15~28VDC	15~28VDC
	Logic 0 Input Voltage	0~5VDC	0~5VDC
	Max. Input Frequency	20KHz	20KHz
	Power	Power Supply	24 VDC (-15%/+20%)
Specification	Power Consumption	Nominal 255mA@24VDC, Max. 540mA@24VDC	Nominal 100mA@24VDC, Max. 530mA@24VDC
	Current for-Internal Bus	Max. 2A@5VDC	Max. 2A@5VDC
	Current Consumption	520mA@5VDC	350mA @ 5VDC
	Electrical Isolation	Logic to Field Power Isolation: Yes	Logic to Field Power Isolation: Yes
	Back-up Fuse	≤ 1.6A Self-recovery	≤ 1.6A Self-recovery
	PCB Coating	Yes	Yes
	Enclosure	Plastic	Plastic
	Dimensions WxHxD	64x 109 x 81 mm	64x 109 x 81 mm
	Weight	Approx. 0.27 kg	Approx. 0.27 kg
	Mount	35mm DIN rail mounting	35mm DIN rail mounting
Environment	Protection Structure	IP20	IP20
	Storage Temperature	-20° ~ 70° C (-4° ~ 158° F)	-20° ~ 70° C (-4° ~ 158° F)
	Operating Temperature	-10° ~ 60° C (14° ~ 140° F)	-10° ~ 60° C (14° ~ 140° F)
	Relative Humidity	10% ~ 90% (non-condensing)	10% ~ 90% (non-condensing)
Certification	CE	CE marked	CE marked
	EtherNet/IP	ODVA Conformance Test	
	UL	cULus Listed	

Digital Input/Output

Specifications



Model		iR-DI16-K	iR-DM16-P	iR-DM16-N	iR-DQ16-P	iR-DQ16-N	iR-DQ08-R
Input Logic		Sink or Source	Sink or Source	Sink or Source	N/A	N/A	N/A
Number of Inputs		16	8	8	0	0	0
Output Logic		N/A	Source	Sink	Source	Sink	Relay
Number of Outputs		0	8	8	16	16	8
Current Consumption		83mA@5VDC	130mA@5VDC	130mA@5VDC	196mA@5VDC	205mA@5VDC	220mA@5VDC
HIGH Level Input Voltage		15~28VDC	15~28VDC	15~28VDC	N/A	N/A	N/A
LOW Level Input Voltage		0~5 VDC	0~5 VDC	0~5 VDC	N/A	N/A	N/A
Output Voltage		N/A	11~28VDC	11~28VDC	11~28VDC	11~28VDC	250VAC/ 30VDC
Output Current		N/A	0.5A per channel (Max 4A)	0.5A per channel (Max 4A)	0.5A per channel (Max 4A)	0.5A per channel (Max 4A)	2A per channel (Max 8A)
Isolation		Input: Optical Isolation Output: N/A	Input: Optical Isolation Output: Optical Isolation	Input: Optical Isolation Output: Optical Isolation	Input: N/A Output: Optical Isolation	Input: N/A Output: Optical Isolation	Input: N/A Output: Electromagnetic Isolation
Specification	Enclosure	Plastic	Plastic	Plastic	Plastic	Plastic	Plastic
	Dimensions WxHxD	27 x 109 x 81 mm	27 x 109 x 81 mm	27 x 109 x 81 mm	27 x 109 x 81 mm	27 x 109 x 81 mm	27 x 109 x 81 mm
	Weight	Approx. 0.12 kg	Approx. 0.12 kg	Approx. 0.12 kg	Approx. 0.12 kg	Approx. 0.12 kg	Approx. 0.13 kg
	Mount	35mm DIN rail mounting	35mm DIN rail mounting	35mm DIN rail mounting	35mm DIN rail mounting	35mm DIN rail mounting	35mm DIN rail mounting
Environment	Protection Structure	IP20	IP20	IP20	IP20	IP20	IP20
	Storage Temperature	-20° ~ 70° C (-4° ~ 158° F)	-20° ~ 70° C (-4° ~ 158° F)	-20° ~ 70° C (-4° ~ 158° F)	-20° ~ 70° C (-4° ~ 158° F)	-20° ~ 70° C (-4° ~ 158° F)	-20° ~ 70° C (-4° ~ 158° F)
	Operating Temperature	0° ~ 55° C (32° ~ 131° F)	0° ~ 55° C (32° ~ 131° F)	0° ~ 55° C (32° ~ 131° F)	0° ~ 55° C (32° ~ 131° F)	0° ~ 55° C (32° ~ 131° F)	0° ~ 55° C (32° ~ 131° F)
	Relative Humidity	10% ~ 90% (non-condensing)	10% ~ 90% (non-condensing)	10% ~ 90% (non-condensing)	10% ~ 90% (non-condensing)	10% ~ 90% (non-condensing)	10% ~ 90% (non-condensing)
Connection	Cross-section	AWG 28-16	AWG 28-16	AWG 28-16	AWG 28-16	AWG 28-16	AWG 24-16
Certification	EMC Immunity	Conforms to EN 55032: 2012+AC: 2013, Class A; EN 61000-6-4: 2007+A1:2011; EN 55024: 2010+A1: 2015; EN 61000-6-2:2005	Conforms to EN 55032: 2012+AC: 2013, Class A; EN 61000-6-4: 2007+A1:2011; EN 55024: 2010+A1: 2015; EN 61000-6-2:2005	Conforms to EN 55032: 2012+AC: 2013, Class A; EN 61000-6-4: 2007+A1:2011; EN 55024: 2010+A1: 2015; EN 61000-6-2:2005	Conforms to EN 55032: 2012+AC: 2013, Class A; EN 61000-6-4: 2007+A1:2011; EN 55024: 2010+A1: 2015; EN 61000-6-2:2005	Conforms to EN 55032: 2012+AC: 2013, Class A; EN 61000-6-4: 2007+A1:2011; EN 55024: 2010+A1: 2015; EN 61000-6-2:2005	Conforms to EN 55032: 2012+AC: 2013, Class A; EN 61000-6-4: 2007+A1:2011; EN 55024: 2010+A1: 2015; EN 61000-6-2:2005
	UL	cULus Listed	cULus Listed	cULus Listed	cULus Listed	cULus Listed	cULus Listed

Analog Input/Output

Specifications



Model		iR-AI04-VI	iR-AM06-VI	iR-AQ04-VI
Number of Analog Inputs		4 (±10V/ ±20mA)	4 (±10V/ ±20mA)	0
Number of Analog outputs		0	2 (±10V/ ±20mA)	4 (±10V/ ±20mA)
Current Consumption		70mA@5VDC	70mA@5VDC	65mA@5VDC
Analog Power Supply		24 VDC(20.4 VDC~28.8 VDC) (-15%~+20%)	24 VDC(20.4 VDC~28.8 VDC) (-15%~+20%)	24 VDC(20.4 VDC~28.8 VDC) (-15%~+20%)
Specification	PCB Coating	Yes	Yes	Yes
	Enclosure	Plastic	Plastic	Plastic
	Dimensions WxHxD	27 x 109 x 81 mm	27 x 109 x 81 mm	27 x 109 x 81 mm
	Weight	Approx. 0.12 kg	Approx. 0.12 kg	Approx. 0.12 kg
	Mount	35mm DIN rail mounting	35mm DIN rail mounting	35mm DIN rail mounting
Environment	Protection Structure	IP20	IP20	IP20
	Storage Temperature	-20° ~ 70° C (-4° ~ 158° F)	-20° ~ 70° C (-4° ~ 158° F)	-20° ~ 70° C (-4° ~ 158° F)
	Operating Temperature	0° ~ 55° C (32° ~ 131° F)	0° ~ 55° C (32° ~ 131° F)	0° ~ 55° C (32° ~ 131° F)
	Relative Humidity	10% ~ 90% (non-condensing)	10% ~ 90% (non-condensing)	10% ~ 90% (non-condensing)
Connection	Cross-section	AWG 28-16	AWG 28-16	AWG 24-16
Certification	EMC Immunity	Conforms to EN 55032: 2012+AC: 2013, Class A; EN 61000-6-4: 2007+A1:2011; EN 55024: 2010+A1: 2015; EN 61000-6-2:2005	Conforms to EN 55032: 2012+AC: 2013, Class A; EN 61000-6-4: 2007+A1:2011; EN 55024: 2010+A1: 2015; EN 61000-6-2:2005	Conforms to EN 55032: 2012+AC: 2013, Class A; EN 61000-6-4: 2007+A1:2011; EN 55024: 2010+A1: 2015; EN 61000-6-2:2005
	UL	cULus Listed	cULus Listed	cULus Listed

Temperature

Specifications



	Model	iR-AI04-TR
Number of Input Channels		4 (RTD/Thermocouple)
Current Consumption		65mA@5VDC
Analog Power Supply		24 VDC(20.4 VDC~28.8 VDC) (-15%~+20%)
Specification	PCB Coating	Yes
	Enclosure	Plastic
	Dimensions WxHxD	27 x 109 x 81 mm
	Weight	Approx. 0.12 kg
	Mount	35mm DIN rail mounting
Environment	Protection Structure	IP20
	Storage Temperature	-20° ~ 70° C (-4° ~ 158° F)
	Operating Temperature	0° ~ 55° C (32° ~ 131° F)
	Relative Humidity	10% ~ 90% (non-condensing)
Connection	Cross-section	AWG 28-16
Certification	EMC Immunity	Conforms to EN 55032: 2012+AC: 2013, Class A; EN 61000-6-4: 2007+A1:2011; EN 55024: 2010+A1: 2015; EN 61000-6-2:2005
	UL	cULus Listed

Motion Control

Specifications



	Model	iR-PU01-P
		Digital input/ output
		Differential input/ output
Input Logic		Sink Input
Number of Inputs		4
Output Logic		Source Output
Number of Outputs		4
HIGH Level Input Voltage		15~28 VDC
LOW Level Input Voltage		0~5 VDC
Input current		24 VDC, 5 mA
Input Impedance		3 KΩ
Indicators		Red LED Input State
Output Voltage		24VDC
Output Current		50 mA
Max. input frequency		200KHz
Max. Output frequency		40KHz
Number of Axis		1- Axis
Specification	PCB Coating	Yes
	Enclosure	Plastic
	Dimensions WxHxD	27 x 109 x 81 mm
	Weight	Approx. 0.12 kg
	Mount	35mm DIN rail mounting
Environment	Protection Structure	IP20
	Storage Temperature	-20° ~ 70° C (-4° ~ 158° F)
	Operating Temperature	0° ~ 55° C (32° ~ 131° F)
	Relative Humidity	10% ~ 90% (non-condensing)
Connection	Cross-section	AWG 28-16
Certification	EMC Immunity	Conforms to EN 55032: 2012+AC: 2013, Class A; EN 61000-6-4: 2007+A1:2011; EN 55024: 2010+A1: 2015; EN 61000-6-2:2005
	UL	cULus Listed

*The terms HDMI, HDMI High-Definition Multimedia Interface, and the HDMI Logo are trademarks or registered trademarks of HDMI Licensing Administrator, Inc.

*CODESYS® is a trademark of CODESYS GmbH.

*Other company names and product names in this document are the trademarks or registered trademarks of their respective companies.

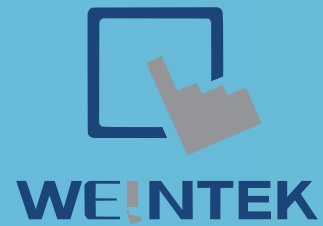

Weintek, as a world-class HMI (Human Machine Interface) manufacturer, is devoted to pioneering cutting-edge solutions that meet dynamic market demands. Our extensive product portfolio consists of HMI, smart gateway devices, automation control equipment, and cloud-based remote monitoring solutions. With our focus on research and development, commitment to quality, and comprehensive after-sales service, we strive to deliver solutions tailored for various industries.

Website: www.weintekiiot.com

Tel: +886-2-22286770 | Fax: +886-2-22286771

Sales: salesmail@weintek.com | Product Support: servicemail@weintek.com

Address: 14F., No. 11, Qiaohe Rd., Zhonghe Dist., New Taipei City 235029, Taiwan, R.O.C.

ENG / 2024.04.15

The contents in this catalog are current as of the publication date. For any updates, please refer to our website for the latest information.

WEINTEK and the WEINTEK logos are trademarks or registered trademarks of Weintek Labs., Inc. in many countries.

© 2023 All rights reserved.