

# Table of Contents

---

Safety Precautions .....	iii
Classification .....	iv
General Cleaning Tips .....	iv
Scrap Computer Recycling .....	vi
<b>SECTION 1 INTRODUCTION.....</b>	<b>1</b>
1.1    General Description .....	1
1.2    System Specifications .....	2
1.2.1    CPU .....	2
1.2.2    BIOS .....	2
1.2.3    System Memory .....	2
1.2.4    Display .....	2
1.2.5    Ethernet Ports .....	3
1.2.6    Storages.....	3
1.2.7    Wireless .....	3
1.2.8    USB .....	3
1.2.9    COM.....	4
1.2.10    Power .....	4
1.2.11    WatchDog Timer (WDT) .....	4
1.2.12    Restore BIOS Optimal Defaults (Clear CMOS) .....	5
1.2.13    System LED.....	5
1.2.14    Operation Temperature.....	5
1.2.15    Storage Temperature .....	5
1.2.16    Humidity .....	5
1.2.17    Weight.....	5
1.2.18    Dimensions .....	6
1.2.19    System I/O Outlets.....	6
1.2.20    DIO .....	6
1.3    Dimensions .....	7
1.4    I/O Outlets.....	8
<b>SECTION 2 HARDWARE INSTALLATION .....</b>	<b>9</b>
2.1    Installing the Memory Module.....	9
2.2    Installing the mSATA module.....	11
2.3    Installing Wireless module .....	12
2.4    Installing the Hard Disk Drive .....	17
2.5    Installing Din-rail Mounting .....	19
2.6    Installing Wall Mounting (optional).....	20
<b>SECTION 3 AMI UEFI BIOS UTILITY .....</b>	<b>21</b>
3.1    Entering Setup .....	21
3.2    The Main Menu .....	21
3.3    Advanced Features .....	22
3.4    Chipset Feature.....	39
3.5    Security.....	41
3.6    Boot Type .....	42
3.7    Save & Exit .....	46
<b>APPENDIX A WATCHDOG TIMER .....</b>	<b>0</b>
About Watchdog Timer .....	0
How to Use Watchdog Timer .....	0

# SECTION 1

## INTRODUCTION

This chapter contains general information and detailed specifications of the . The Chapter 1 includes the following sections:

- General Description
- System Specification
- Dimensions
- I/O Outlets

### 1.1 General Description

Din-rail fanless embedded system is suitable for communications control and for protocol converter applications in critical environments. Built for rugged work environments, features an extra low power consumption Intel® Celeron® N3350(1.1GHz) or N4200 (1.1GHz) processors supporting industrial temperature range of -40°C to +70°C. Its front accessible I/O cabling is very convenient for wiring and maintenance. ICO300 offers a HDMI output, making it particularly well-suited for communication control, SCADA and industrial automation. Its compact size with Din-rail mounting allows for easy installation into control cabinet. Pre-installed with Linux, Windows® 10 embedd , provides programmers with a friendly environment for developing application software at a lower cost.

is robust industrial-grade hardware design and adopts the advanced cooling system, besides, supporting the mSATA and SATA SSD (or HDD), which makes it especially suitable for field control & monitoring system solution for following markets:

Utility Industries (Water; Energy; Chemical Plant; Mining...)

Public Transportation Industries (Traffic/ Highway Control; Train/Bus Control...)

Homeland Security (Weather Monitoring/Alarm System...)

#### ● Checklist

- |                |                            |
|----------------|----------------------------|
| ✓ Screws       | ✓ Power terminal block x 1 |
| ✓ CF Mylar x 1 | ✓ DVD x 1 (for Driver)     |
| ✓ Cable Tie x1 | ✓ Din-rail Kit x1          |
|                | ✓ SATA+Power HDD cable x1  |



**Note:** Please contact your local vendors if any damaged or missing items.

- **Features**

- Fanless design
- Wide temperature operation of -40°C - +70°C
- 2 10/100/1000 Base-T Ethernets with Magnetic Isolated Protection
- 4 COM Ports support RS-232/422/485
- 2 Wireless (USB and PCIe Interface)
- Support one 2.5" SATA drive bay (or mSATA )
- Wide range 12–24V DC-in with terminal block
- 1 DI/DO (8-bit programmable, DB9 female connector)
- Din-rail mounting
- Wall mounting (optional)
- Passed CE with FCC testing

- **Embedded O.S. Supported**

- not only supports Windows<sup>®</sup> 10, but also supports embedded OS, such as Windows<sup>®</sup> 10 embedded and Linux package support. For storage device, supports one SATA SSD (or HDD) and one mSATA.

## 1.2 System Specifications

### 1.2.1 CPU

- Onboard Intel<sup>®</sup> Celeron<sup>®</sup> N3350 (1.1GHz) or N4200 (1.1GHz)

### 1.2.2 BIOS

- AMI (American Megatrends Inc.) UEFI (Unified Extensible Firmware Interface) BIOS.

### 1.2.3 System Memory

- One DDR3L 204-pin SO-DIMM (1.35V) slot.
- Supports 1333/1600 MHz up to 8GB.

### 1.2.4 Display

- 1 x HDMI (up to 1920 x 1200 @60Hz)

### 1.2.5 Ethernet Ports

- LAN Chip: Intel Ethernet Controller I211-AT.
- LAN 1 and LAN 2

The board has dual RJ-45 connectors, support 10/100/1000 Base-T with 1.5KV magnetic isolated protection.

### 1.2.6 Storages

- 1 x 2.5" SATA drive bay.
- 1 x mSATA.

### 1.2.7 Wireless

- 2 x Full size Mini Card slot supports module with USB and PCIe Interface.
- 1 x SIM Card Socket.
- 3 x Antenna holes.

### 1.2.8 USB

- 4 x USB3.0
- USB Pin Define :

Pin	Signal USB Port 0/1	Pin	Signal USB Port 2/3
1	VCC	10	VCC
2	D-	11	D-
3	D+	12	D+
4	GND	13	GND
5	SSRX-	14	SSRX-
6	SSRX+	15	SSRX+
7	GND	16	GND
8	SSTX-	17	SSTX-
9	SSTX+	18	SSTX+

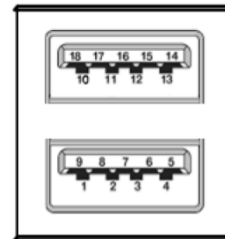

### 1.2.9 COM

- 4 ports DB9 support RS-232/422/485 which can be selected by BIOS.
- Supports Auto Flow Control in RS485 mode.
- Serial Port Pin Define: (DB9 Male) as below

#### COM1~4

Pin	RS-232	RS-422	RS-485
1	DCD	TX-	Data-
2	RXD	TX+	Data+
3	TXD	RX+	--
4	DTR	RX-	--
5	GND	GND	GND
6	DSR	--	--
7	RTS	--	--
8	CTS	--	--
9	RI	--	--

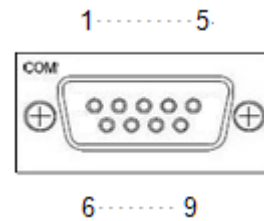

### 1.2.10 Power

- Wide-range 12 - 24V DC power input with terminal block.
- OVP and Reverse protection.

Pin	Signal
1	+
2	NC
3	-

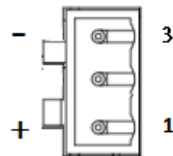

### 1.2.11 WatchDog Timer (WDT)

- 1~255 seconds or minutes; up to 255 levels.

### 1.2.12 Restore BIOS Optimal Defaults (Clear CMOS)

- Press the tact switch can restore BIOS optimal defaults.

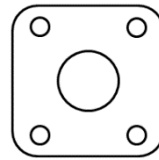
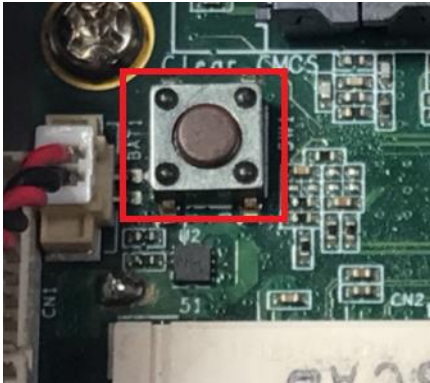

### 1.2.13 System LED

- There are showed the LED's indicators and functional descriptions.

LED Name	Description	Color
ACT	Indicate the storage status and it's flashing when storage access.	Green
PWR	Indicate the Power status. When the DC input is acceptable, the LED will ON.	Yellow

### 1.2.14 Operation Temperature

- $-40^{\circ}\text{C} \sim +70^{\circ}\text{C}$

### 1.2.15 Storage Temperature

- $-40^{\circ}\text{C} \sim +85^{\circ}\text{C}$

### 1.2.16 Humidity

- 10% ~ 95% (non-condensation)

### 1.2.17 Weight

- 1 kg

### 1.2.18 Dimensions

- 48mm(1.88") (W) x110mm(4.33") (D) x155mm(6.1") (H)

### 1.2.19 System I/O Outlets

- Four 9-pin D-Sub male connectors, COM1~COM4.
- One HDMI.
- Two 10/100/1000 Base-T RJ-45 with 1.5KV magnetic isolated protection.
- Four USB 3.0 connectors.
- One DC Power Input with terminal block.
- Three Antenna holes.

### 1.2.20 DIO

- One DB9 female connector supports 8 bits TTL level programmable digital input/output
- The voltage of TTL is 5V
- The programming is as follow:
  - I/O sink current is 8~10mA
  - Input/Output can be programmed

Pin	Signal
1	DIO0
2	DIO1
3	DIO2
4	DIO3
5	DIO4
6	DIO5
7	DIO6
8	DIO7
9	GND

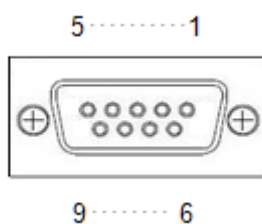

### 1.3 Dimensions

The following diagrams show you dimensions and outlines of the

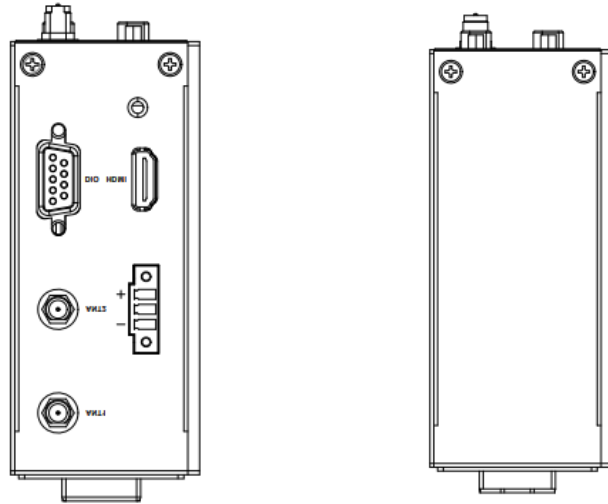



## 1.4 I/O Outlets

The following figures show you I/O outlets on front view and top view of the

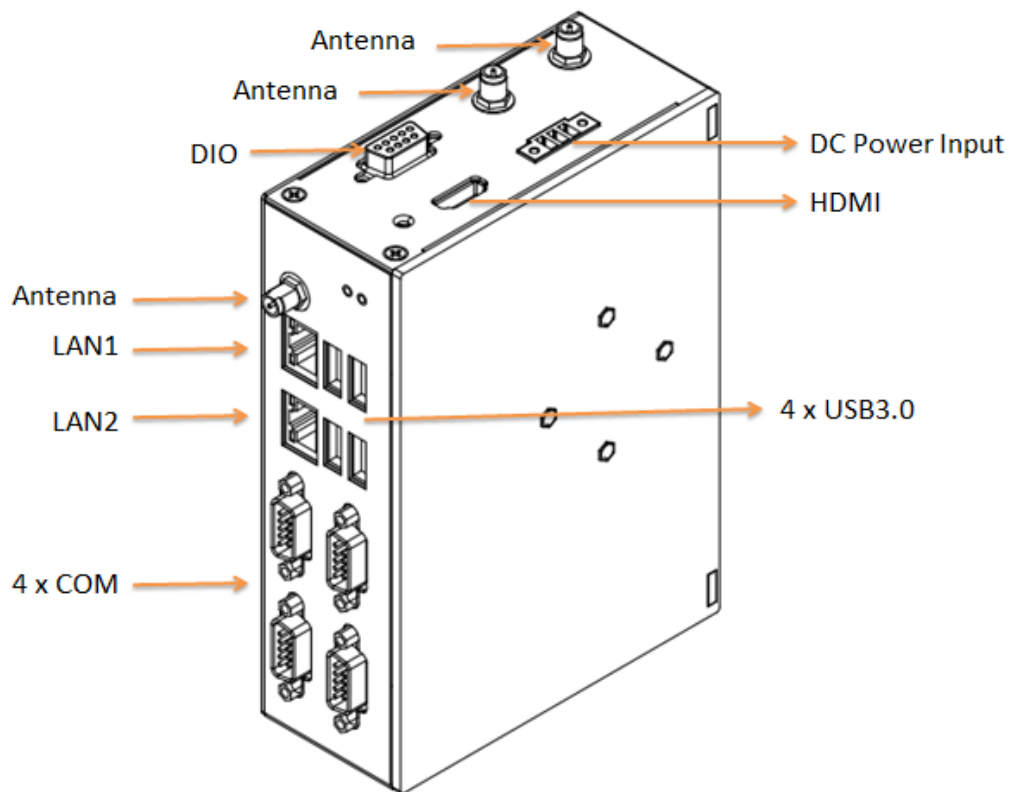

## SECTION 2 HARDWARE INSTALLATION

is convenient for your various hardware configurations, such as Memory Module and Hard Disk Drive. The chapter 2 will show you how to install the hardware. It includes:

### 2.1 Installing the Memory Module

**Step 1** Turn off the system.

**Step 2** Loosen all screws of the cover and remove the cover from the system.

**Step 3** Use two fingers to hold the memory module, and insert the gold figure into the slot and push the module down.

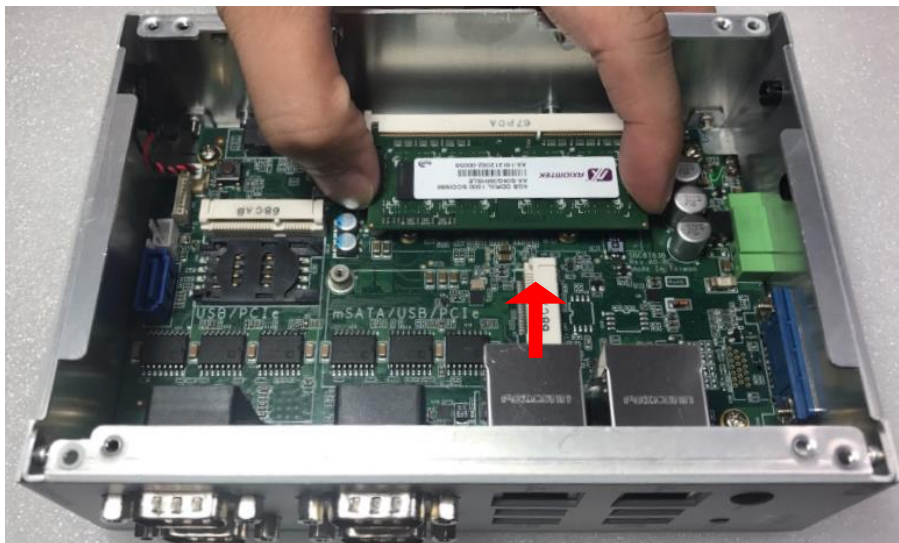

- Step 4** The memory module is locked by two latches on the sides. We strongly recommend using “LDC737” silicone on the two sides of the memory for good ability of vibration.



- Step 5** Put the cover back to the system, and fasten screws tight close the chassis.

## 2.2 Installing the mSATA module

**Step 1** Turn off the system.

**Step 2** Loosen all screws of the cover and remove the cover from the system.

**Step 3** Insert the mSATA into the slot which marking with “mSATA / USB / PCIe ” and fasten screws.

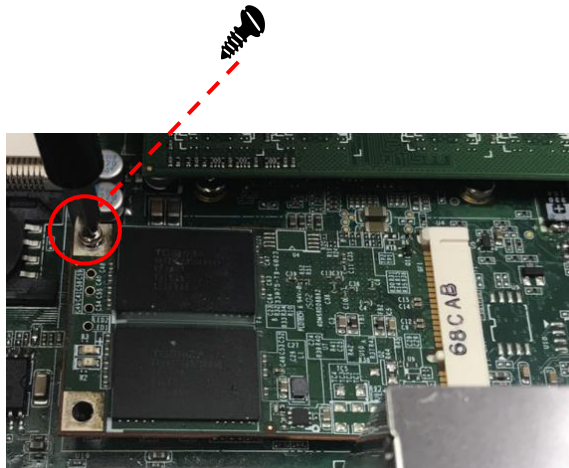

**Step 4** Put the cover back to the system, and fasten screws tight close the chassis.

## 2.3 Installing Wireless module

**Step 1** Turn off the system.

**Step 2** Loosen all screws of the cover and remove the cover from the system.

**Step 3** Following(Figure 3-1) push the SIM slot back to unlock SIM slot, inserting the SIM card and put it back(Figure 3-2), and lock the SIM slot(Figure 3-3).



Figure 3-1

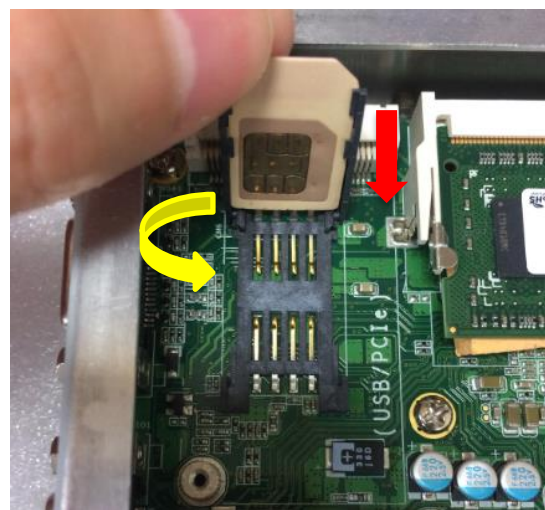

Figure 3-2

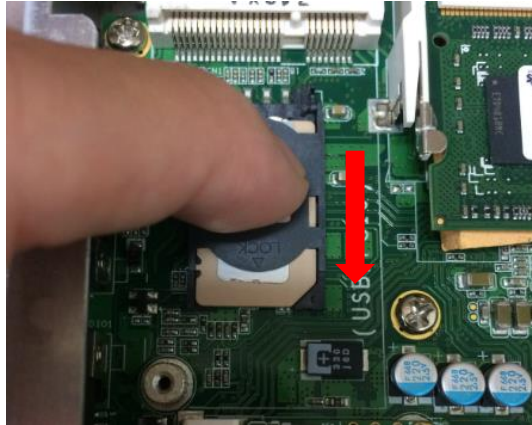

Figure 3-3

**Step4.** Insert the wireless module into the slot which marking with “USB/PCIe”.





**Step 5** Insert the 3G module and screws it tight.



**Step 6** Removing the plug cover from the chassis.

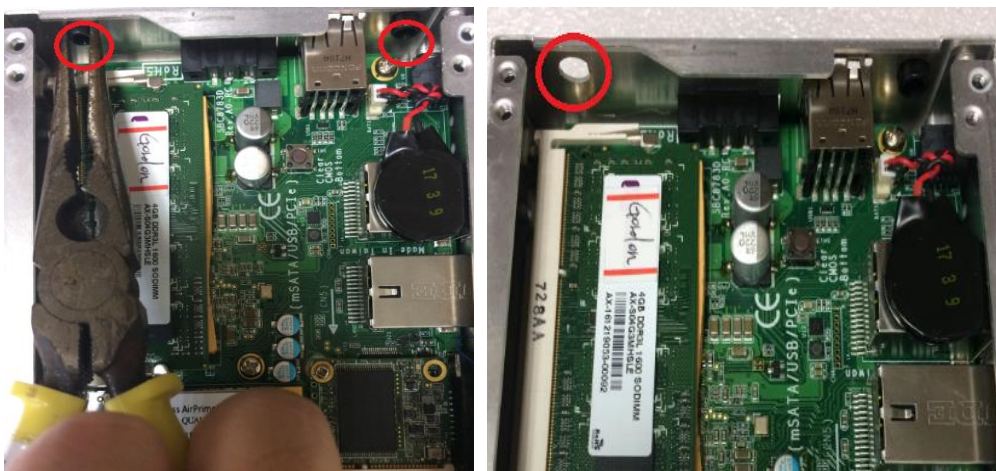

**Step 7** Connect the RF cable to the connector of 3G module which “MAIN”.



**Step 8** Taking out the parts from the 3G kit package (Figure 8-1) and make the RF cable through the antenna hole (Figure 8-2). Finally, screw it tight(Figure 8-3).



Figure 8-1



Figure 8-2



Figure 8-3



**Step 9** Screwing the RF antenna tight.



**Step 10** Put the cover back to the system, and fasten screws tight close the chassis.



*Note: SIM Card only can use the standard size as the following pictures.*

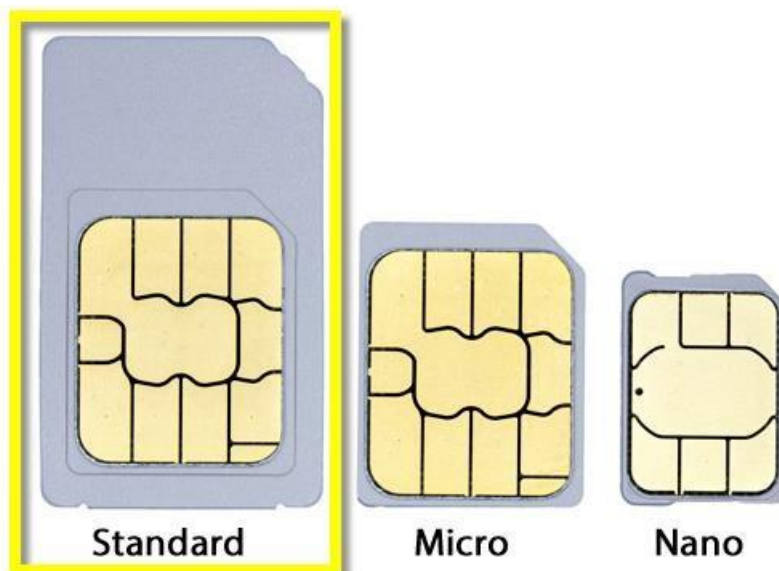

## 2.4 Installing the Hard Disk Drive

**Step 1** Turn off the system.

**Step 2** Loosen all screws of the cover and remove the cover from the system.



**Step 3** Loosen 4pcs screws of the cover, and put the HDD into the HDD bracket and fix the HDD by 4pcs of screws in the accessory bag.

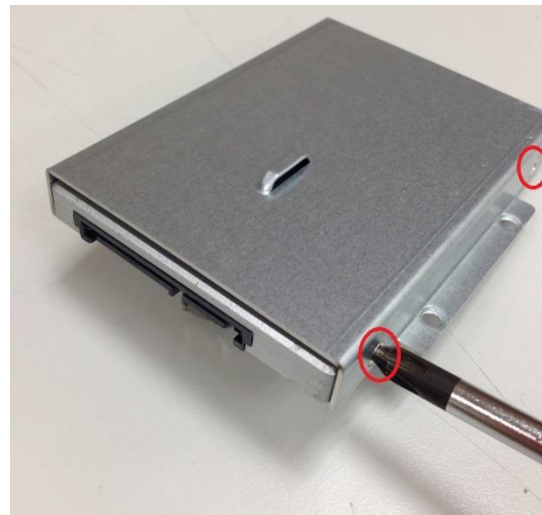
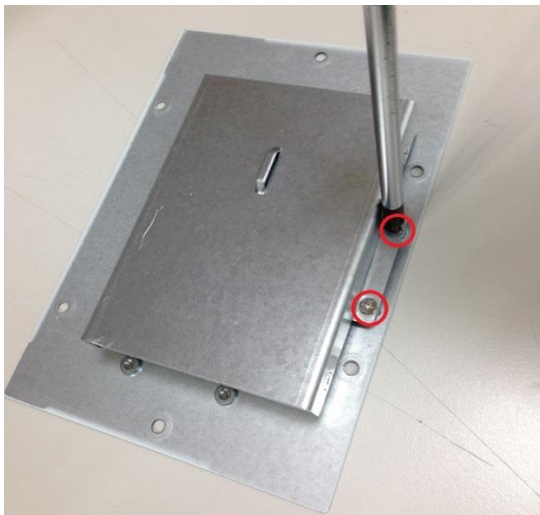

- Step 4** Put the HDD bracket on the cover and use 4pcs screws to fix tightly. Taes the HDD SATA+Power HDD cable and Cable Tie out from the accessory bag and connect SATA+Power HDD cable to HDD then use Cable Tie to fix it on the HDD bracket, cut off the lengthy Cable Tie.

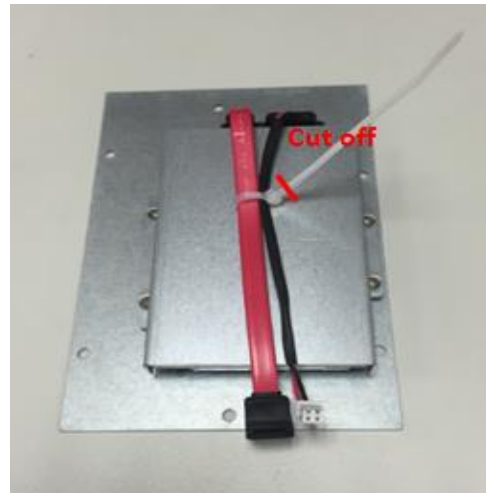

- Step 5** Connect SATA+Power HDD cable to the board connector, SATA side first then power side second.

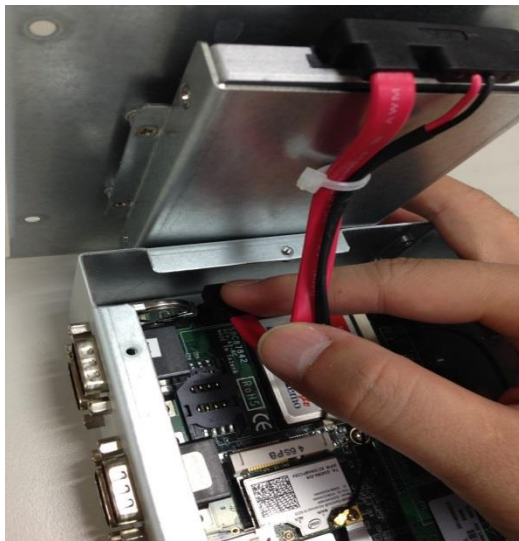

- Step 6** Put the cover back to the system, and fasten screws tight close the chassis.

## 2.5 Installing Din-rail Mounting

The provides Din-rail Mount for 2 methods that customers can install as below:

**Step 1 Prepare Din-rail Mount assembling components (screws and bracket) ready.**



**Step 2 Assembly the bracket to the system and fasten screws tight.**

**Method 1:**



## 2.6 Installing Wall Mounting (optional)

The \_\_\_\_\_ provides Wall Mounting that customers can install as below:

**Step 1** Prepare Wall Mount assembling components (screws and bracket) ready.



**Step 2** Assembly the bracket to the system, and fasten screws tight.



## SECTION 3

# AMI UEFI BIOS UTILITY

The AMI UEFI BIOS provides users with a built-in Setup program to modify basic system configuration. All configured parameters are stored in a flash-backed-up to save the Setup information whenever the power is turned off.

### 3.1 Entering Setup

To enter the setup screens, follow the steps below:

1. Turn on the computer and press the <Del> key immediately.
2. After you press the <Del> key, the main BIOS setup menu displays. You can access the other setup screens from the main BIOS setup menu, such as the Advanced and Chipset menus.

### 3.2 The Main Menu

Once you enter the AMI BIOS Aptio Setup Utility, the Main Menu appears on the screen. In the Main Menu, there are several Setup functions and a couple of Exit options for your selection. Use Select Screen Keys (or Move Keys) to select the Setup Page you intend to configure then press <Enter> to accept or enter its sub-menu.

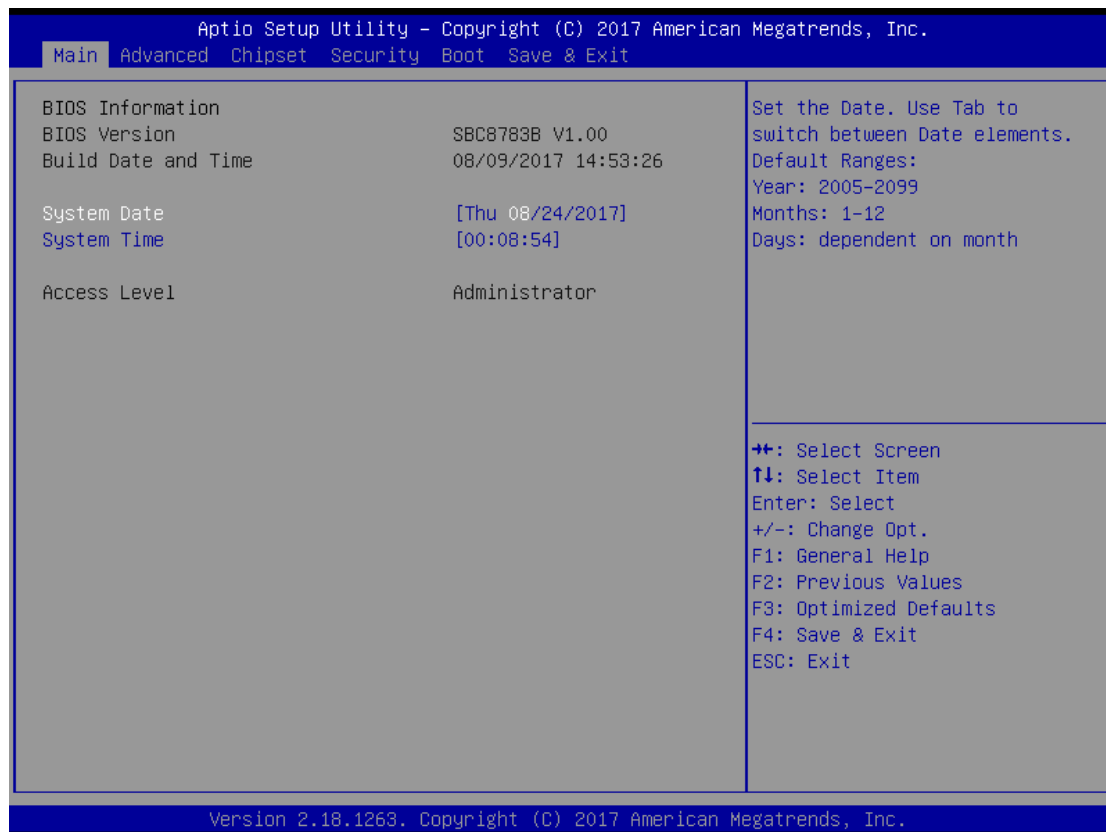

#### System Date

The date format is <day> <month> <date> <year>.

#### System Time

This item shows current time of your system with the format <hour> <minute> <second>. The time is calculated based on the 24-hour military-time clock. For example, 1 p.m. is 13:00:00.

### 3.3 Advanced Features

This Advanced section allows users to configure and improve your system, to set up some system features according to your preference. You can select any of the items in the left frame of the screen to go to the sub menus:

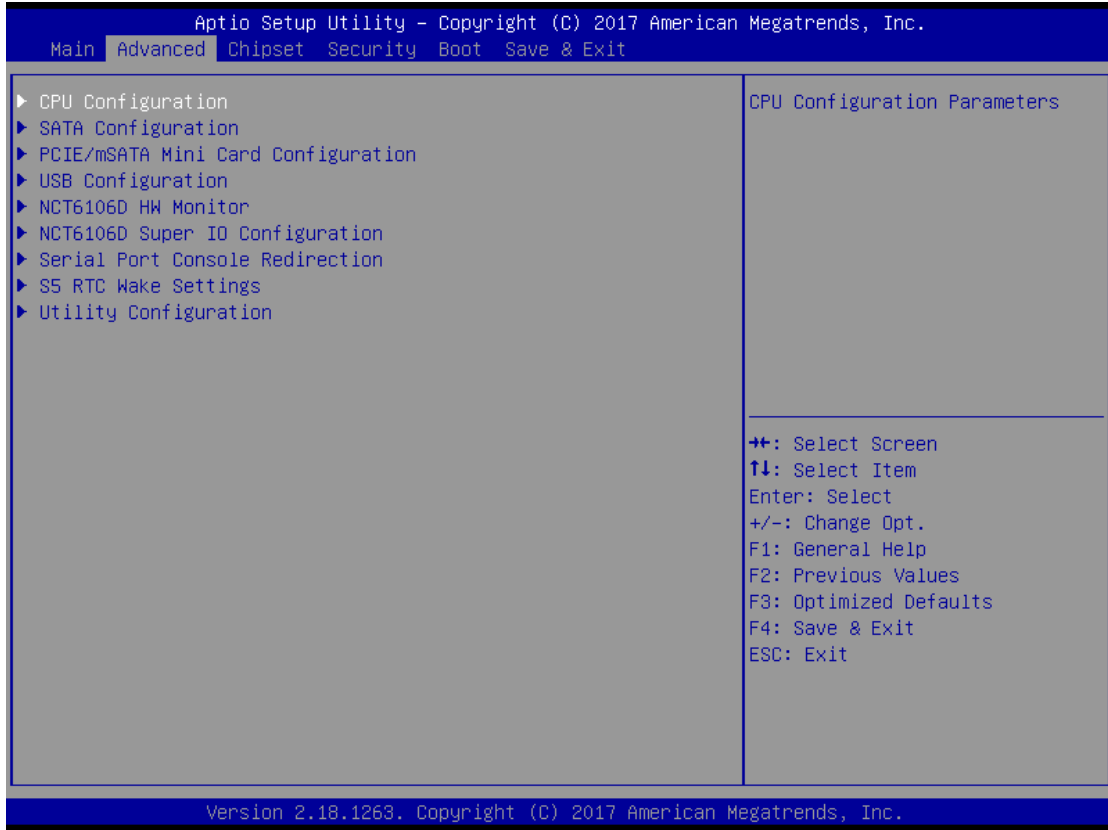



- **CPU Configuration**

Scroll to this item and press <Enter> to view the CPU Configuration informations.

(Please refer below graphics.)

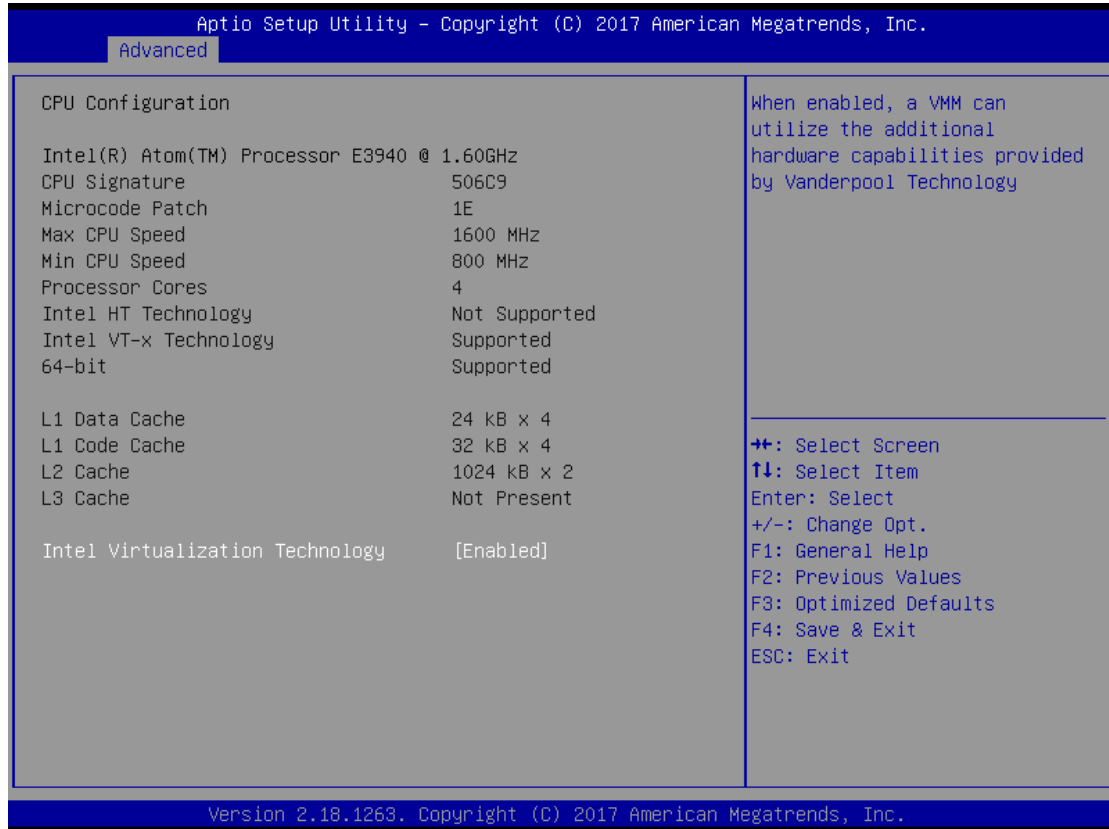



- **SATA Configuration**

Scroll to this item and press <Enter> to view the SATA Configuration informations.

(Please refer below graphics.)

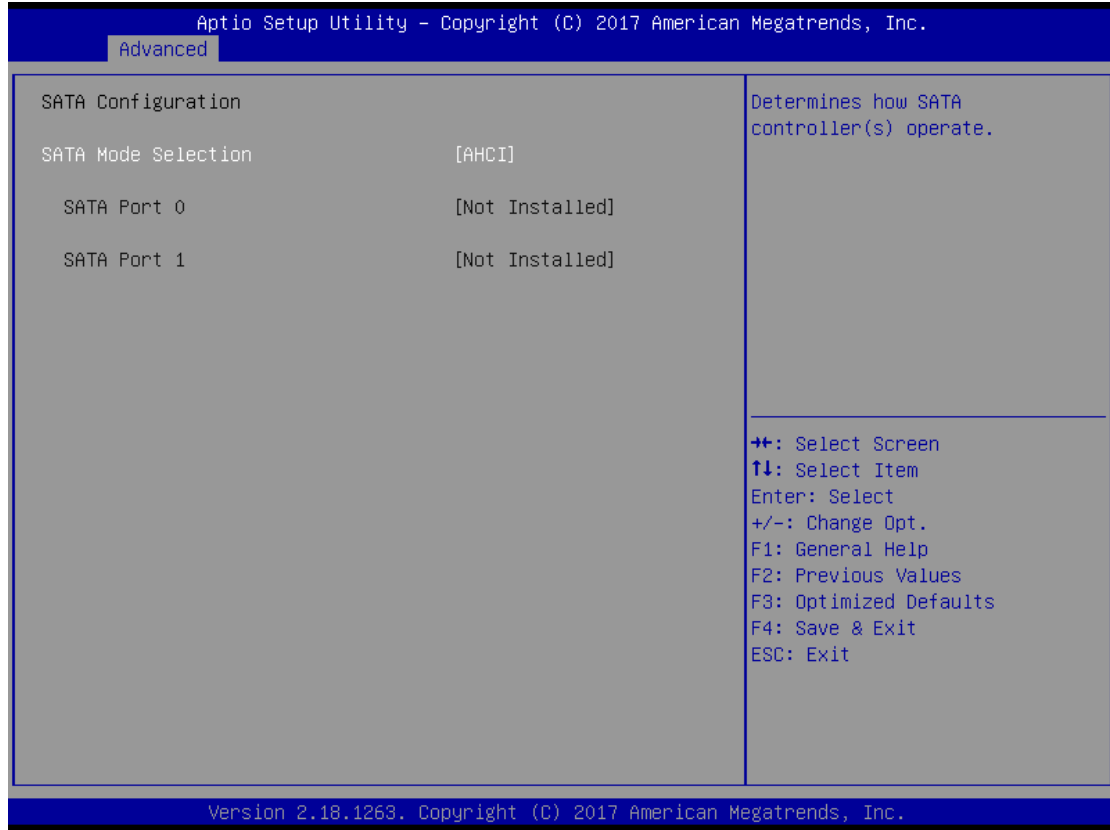

- **PCIe/mSATA Mini Card Configuration**

You can choose the PCIe or mSATA function, it can be select by BIOS menu.

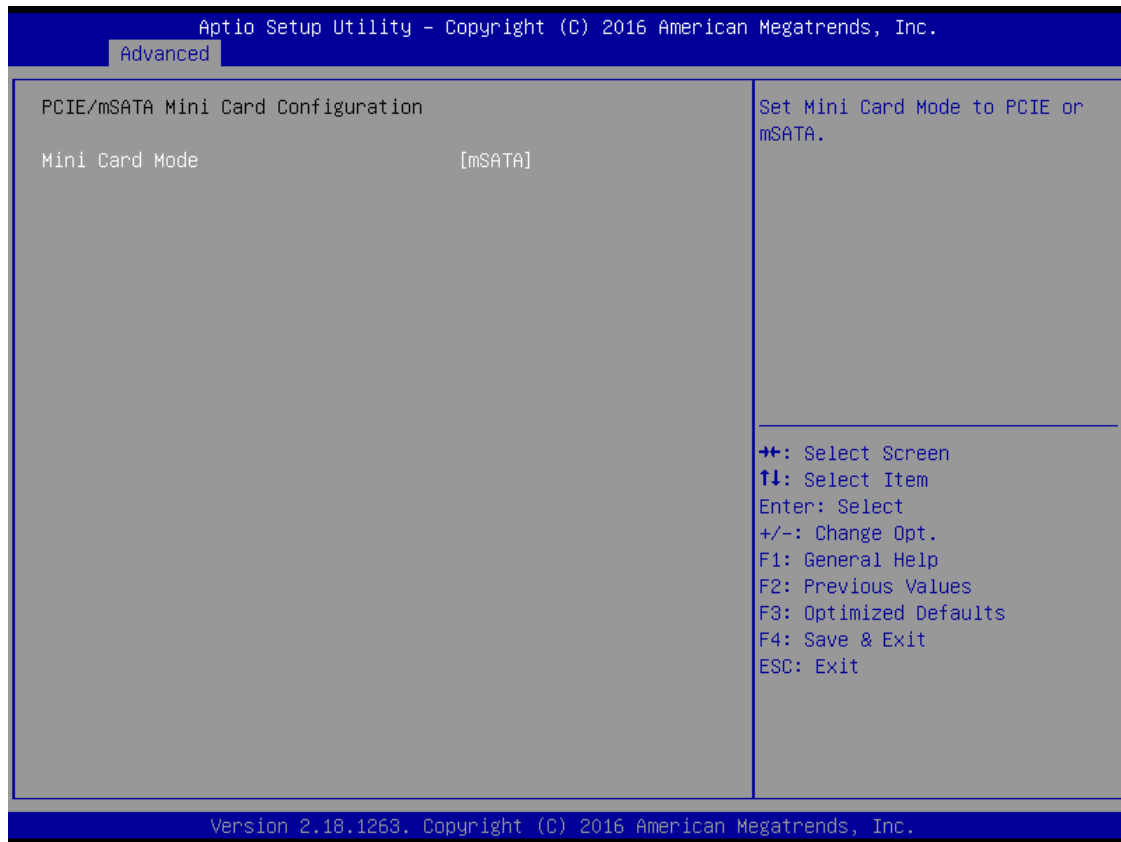

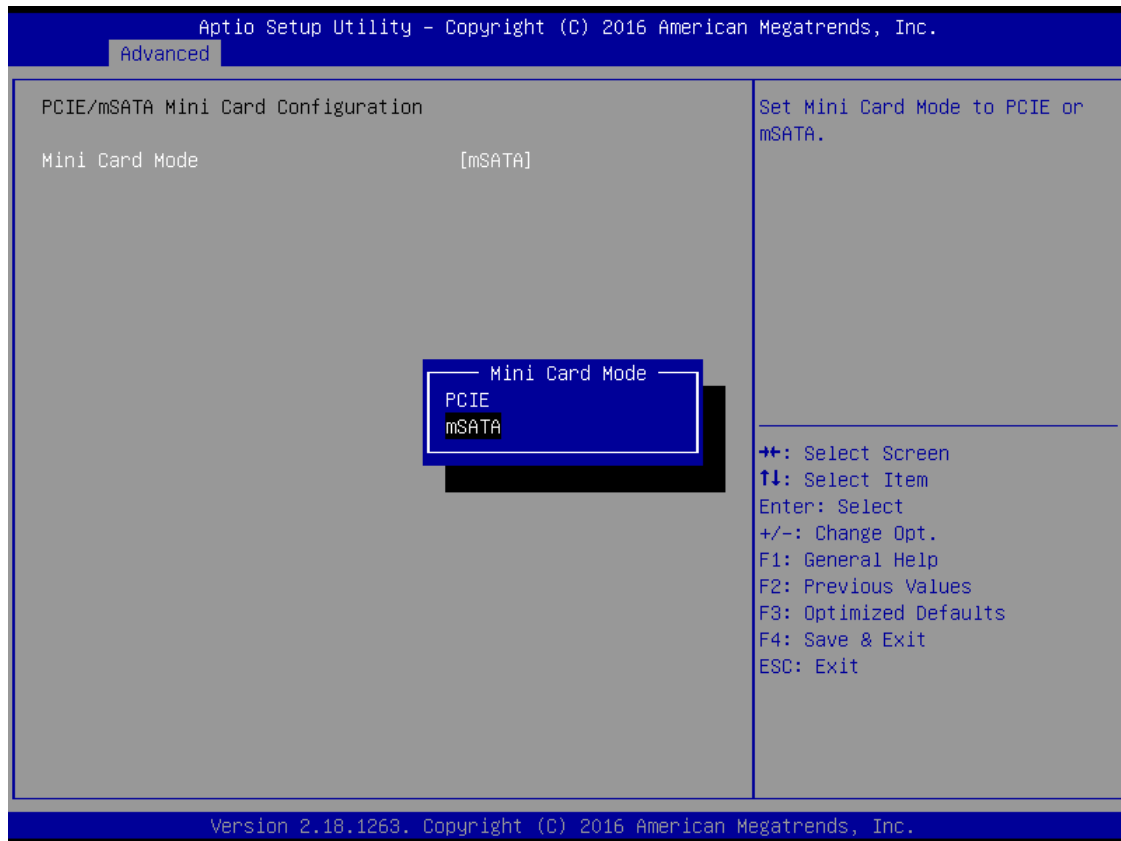

- **USB Configuration**

Scroll to this item and press <Enter> to view the USB Configuration informations.

(Please refer below graphics.)

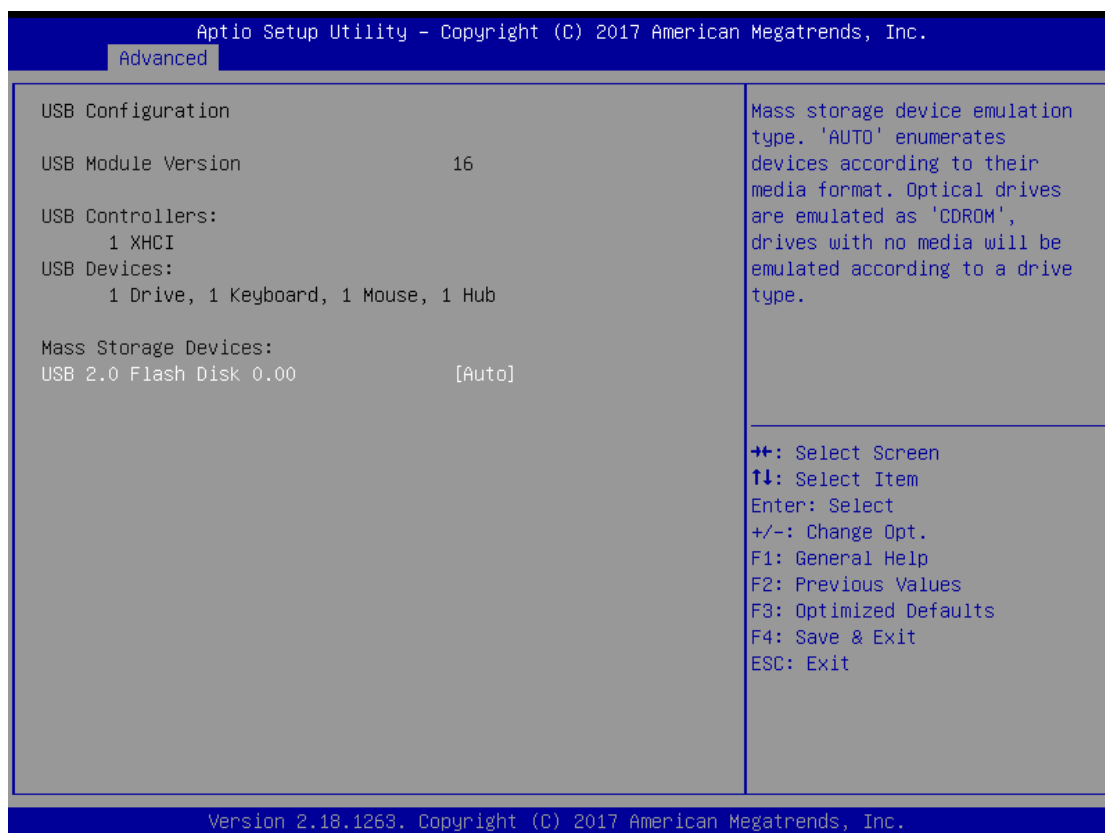

- **H/W Monitor**

Scroll to this item and press <Enter> to view the monitor hardware status.

(Please refer below graphics.)

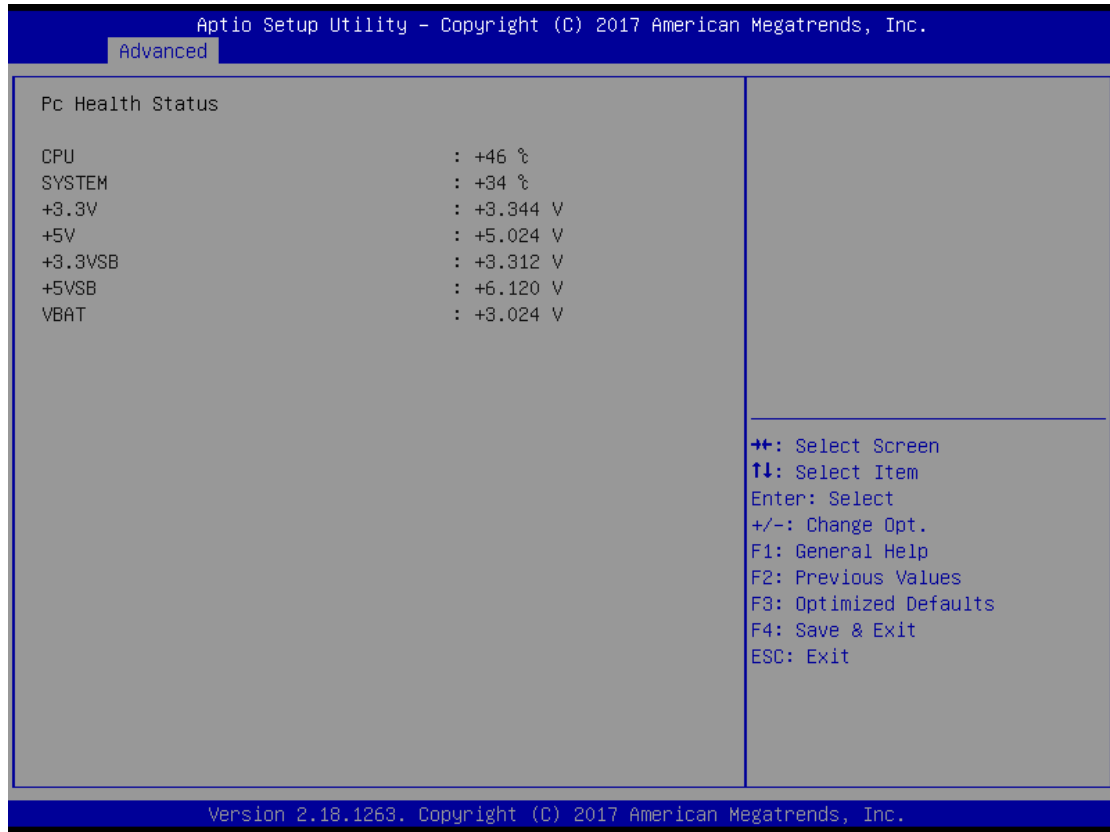

- **NCT6106D Super IO Configuration**

The default setting for all Serial Ports are RS232.

You can change the setting by selecting the value you want in each COM Port Type.

Supports RS422 & RS485 mode.

(Please refer below graphics.)

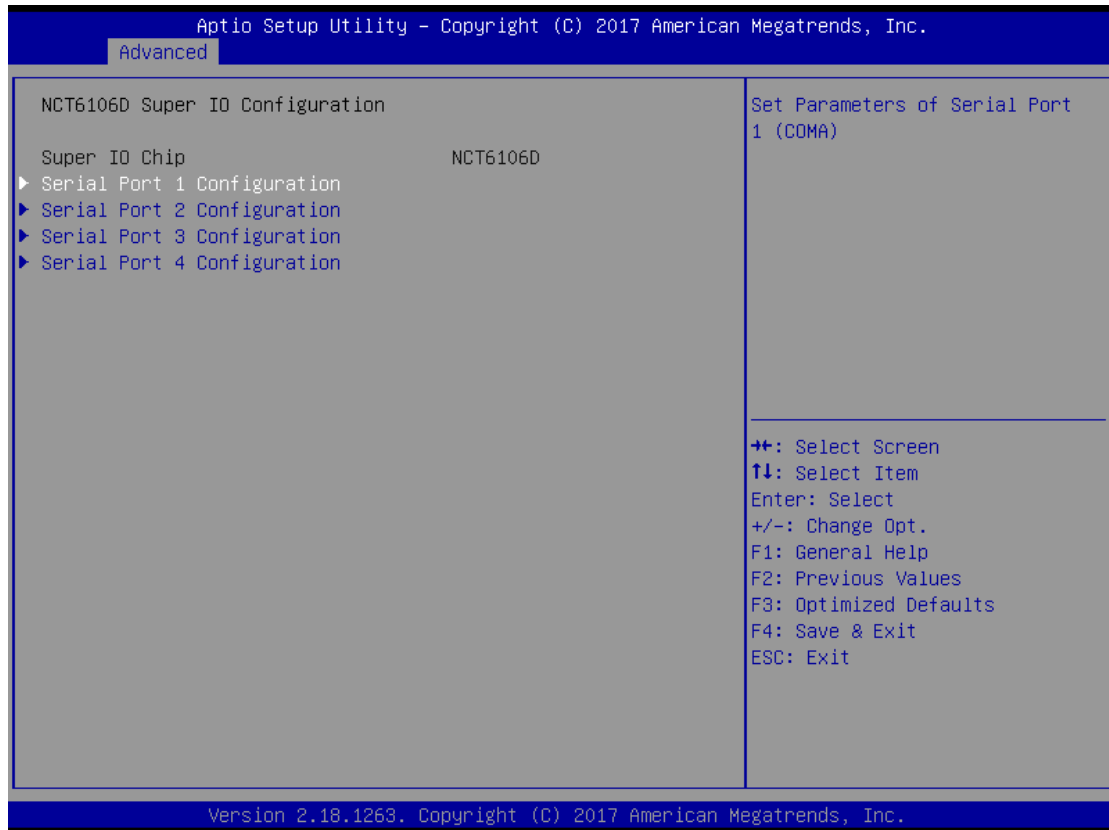

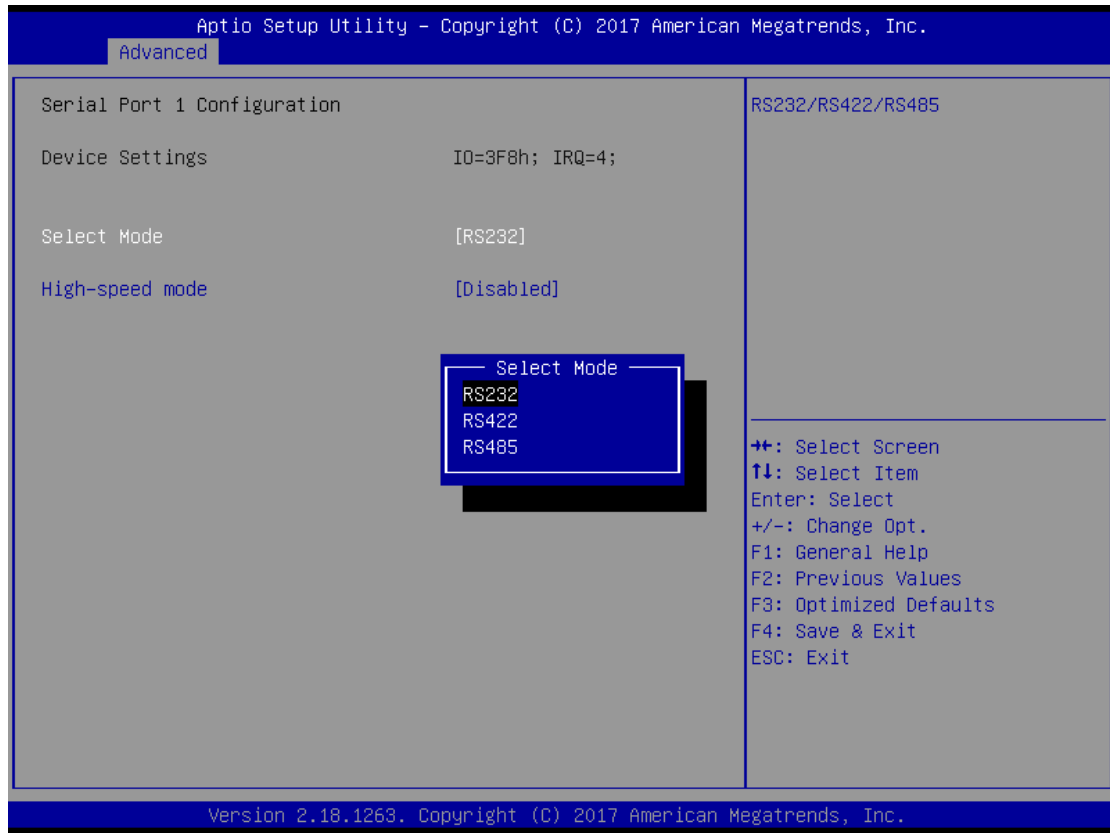

You can enable COM port High-speed mode to support higher speed com port board rate.

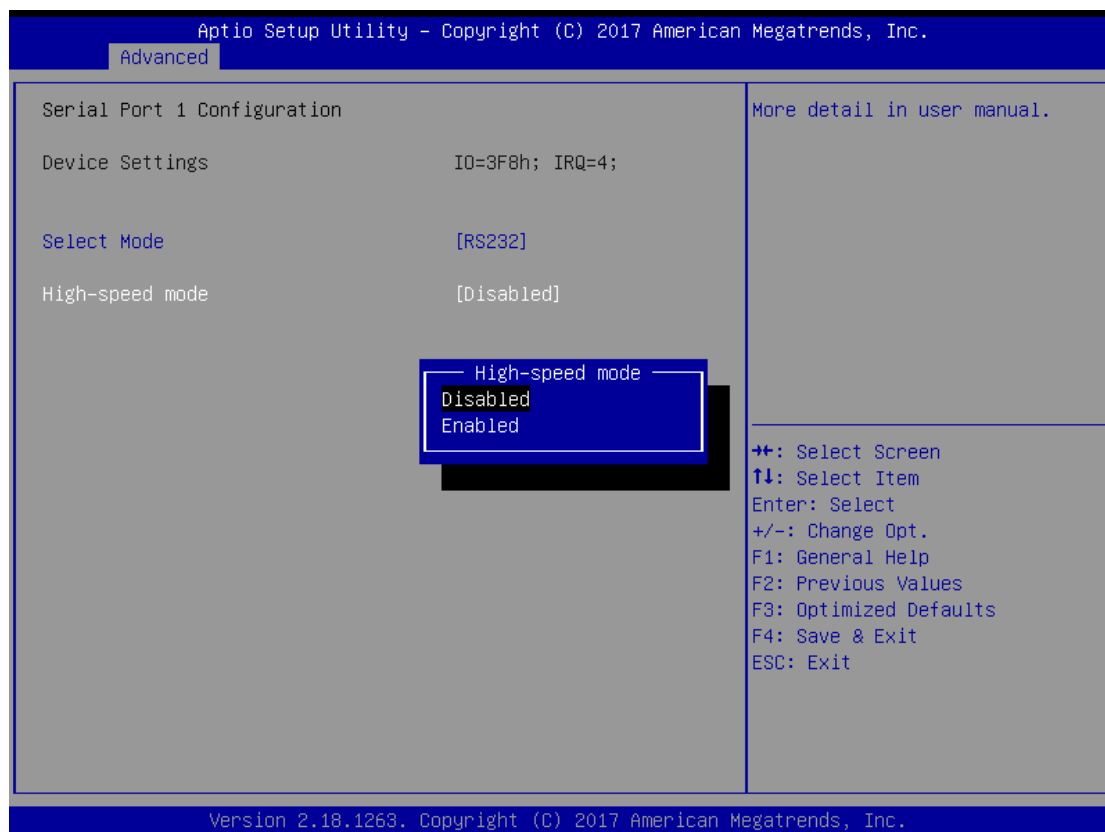

Disable	Enable
50	650
75	975
110	1430
134.5	1478.5
150	1950
300	3900
600	7800
1200	15600
1800	23400
2000	26000
2400	31200
3600	46800
4800	62400
7200	93600
9600	124800
19200	249600
38400	499200
57600	748800
115200	1497600



### Serial Port Console Redirection

Only COM1 has the console redirection function.

The default setting for the console redirection function is [Disabled]

(Please refer below graphics.)



And you can further change the setting by selecting or setting the value you want in each function as the following pictures.

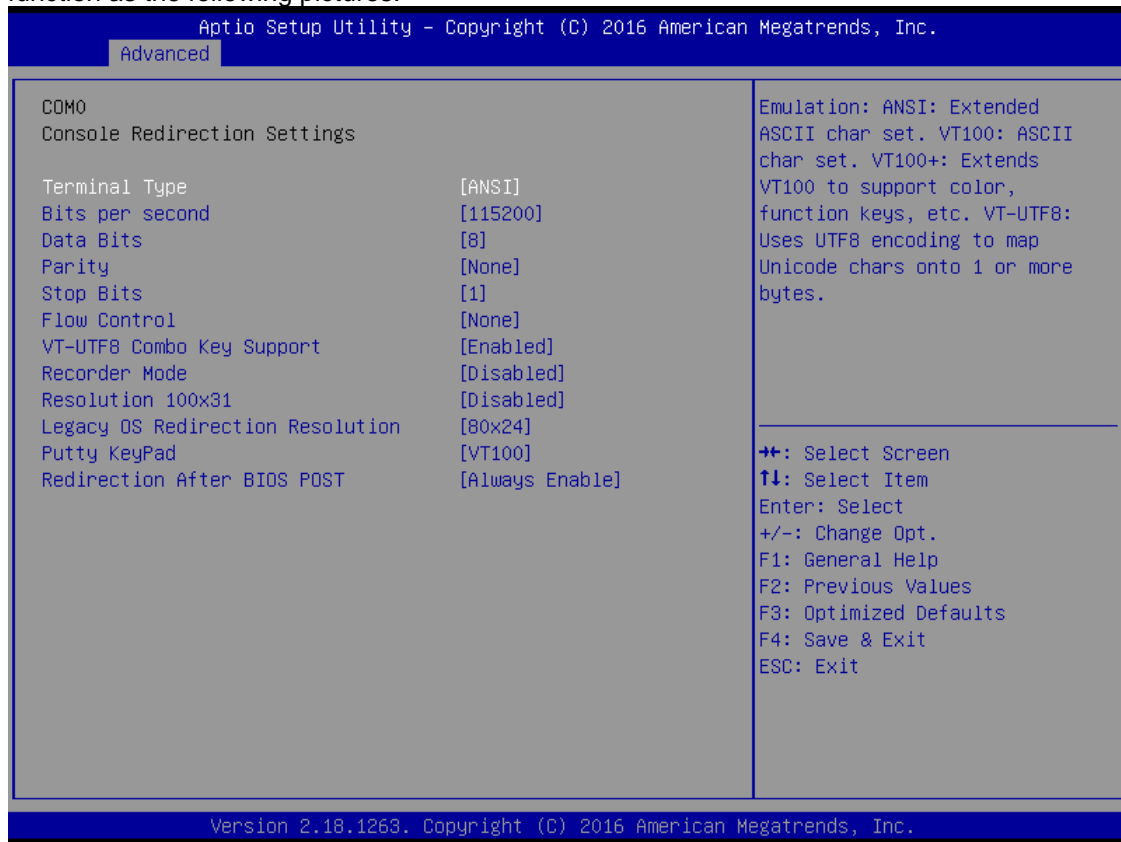

- **RTC Wake Settings**

The default setting is “disable”.

If the setting is changed for “enable”, you can set up the fixed time to boot up automatically.

(Please refer below graphics.)

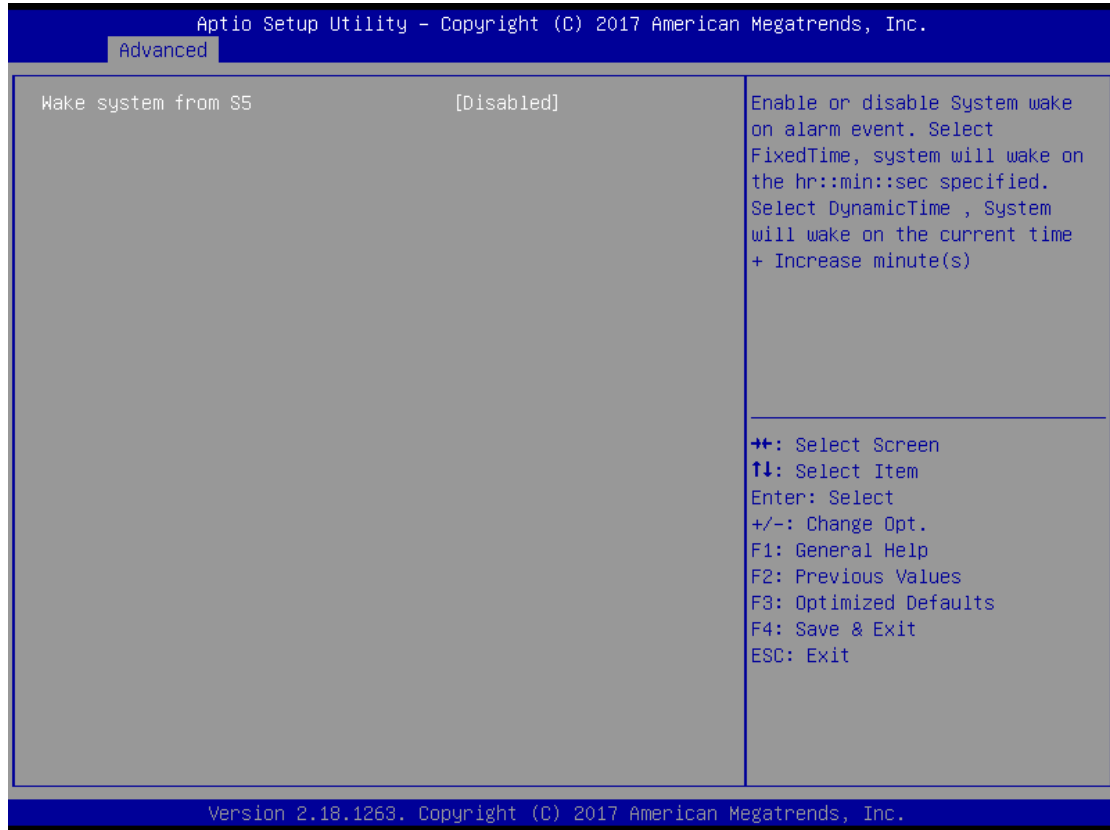

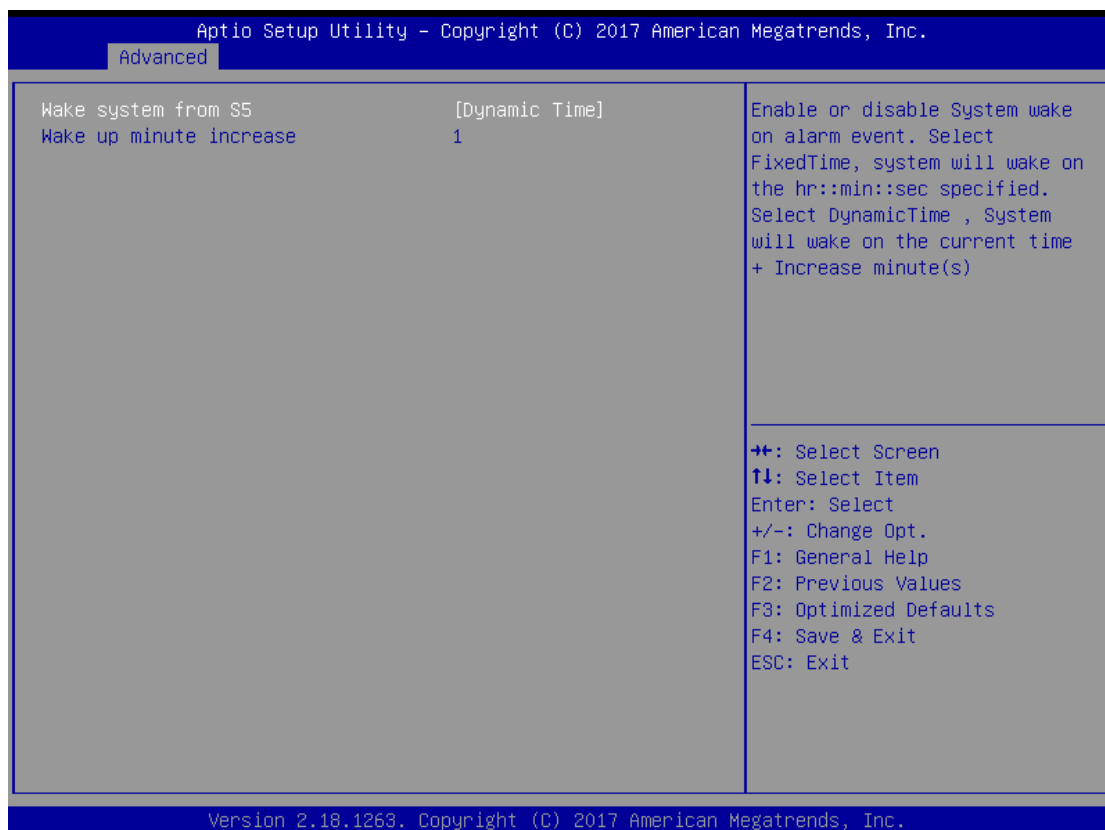
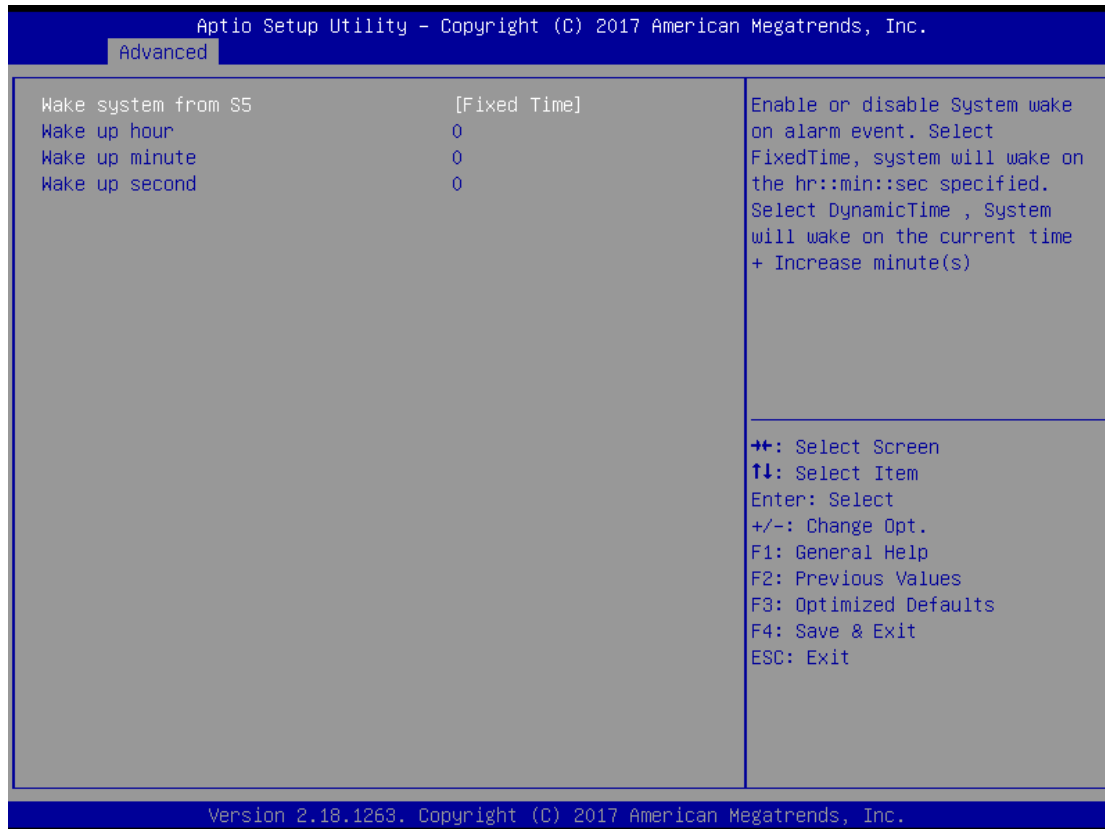

- **Utility Configuration**

BIOS flash utility is a tool for flash BIOS on setup menu, follow the step to flash BIOS.

1. Create a folder and rename to Axiomtek on the root of USB storage (Ex: X:\
2. Copy BIOS file to the Axiomtek folder (Ex: X:\ \SBC8783BV.100)  
(Note : BIOS file name must contain the word SBC8783B)
3. Enter the BIOS flash utility and locate the BIOS file
4. Push "Start flash system BIOS"



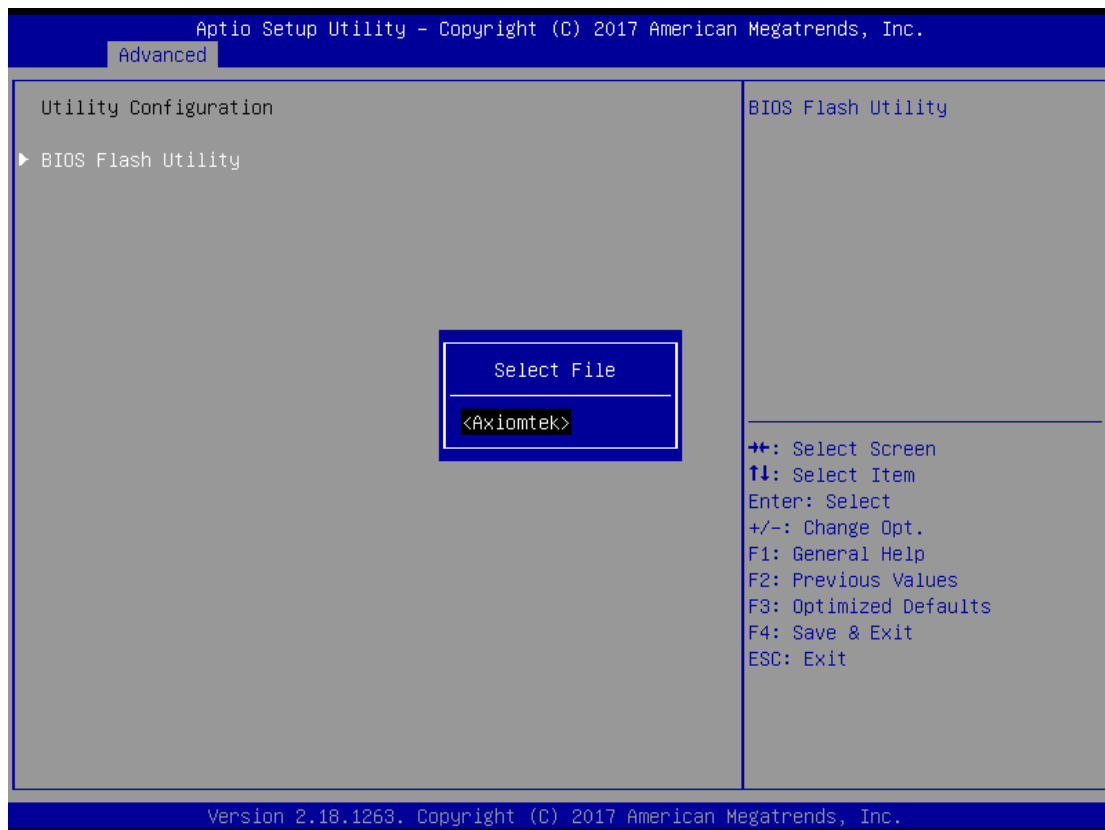
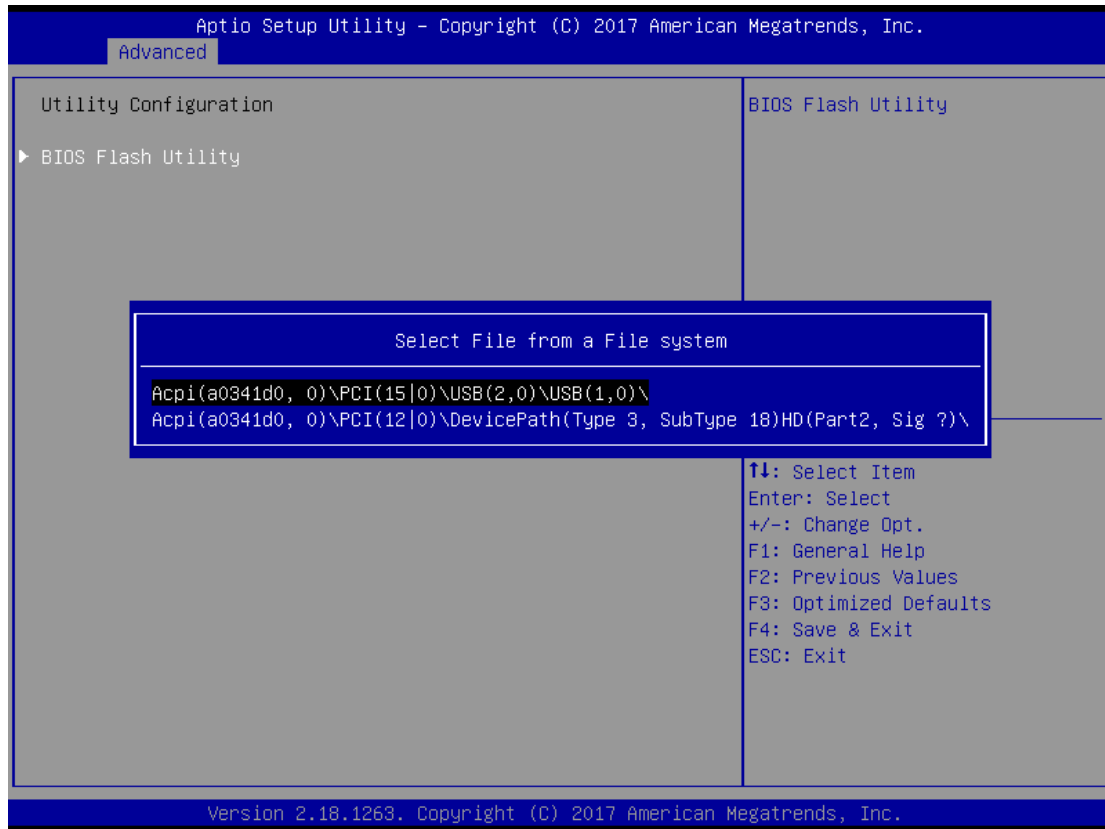

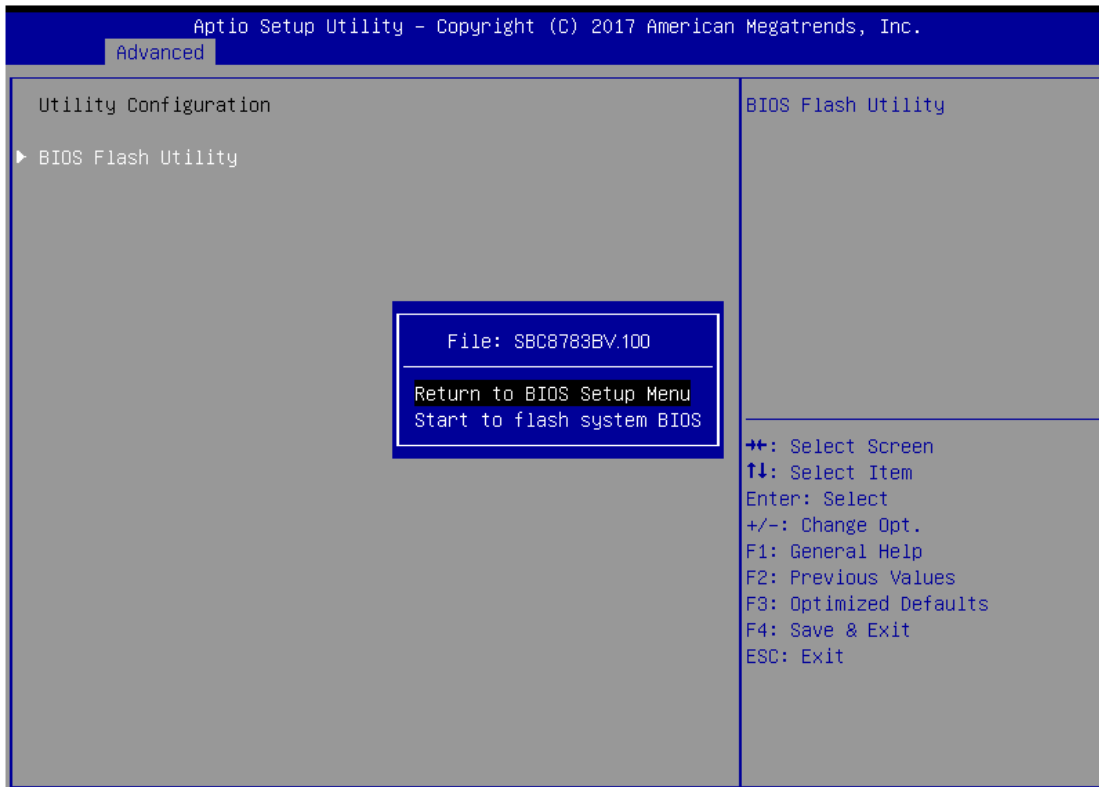
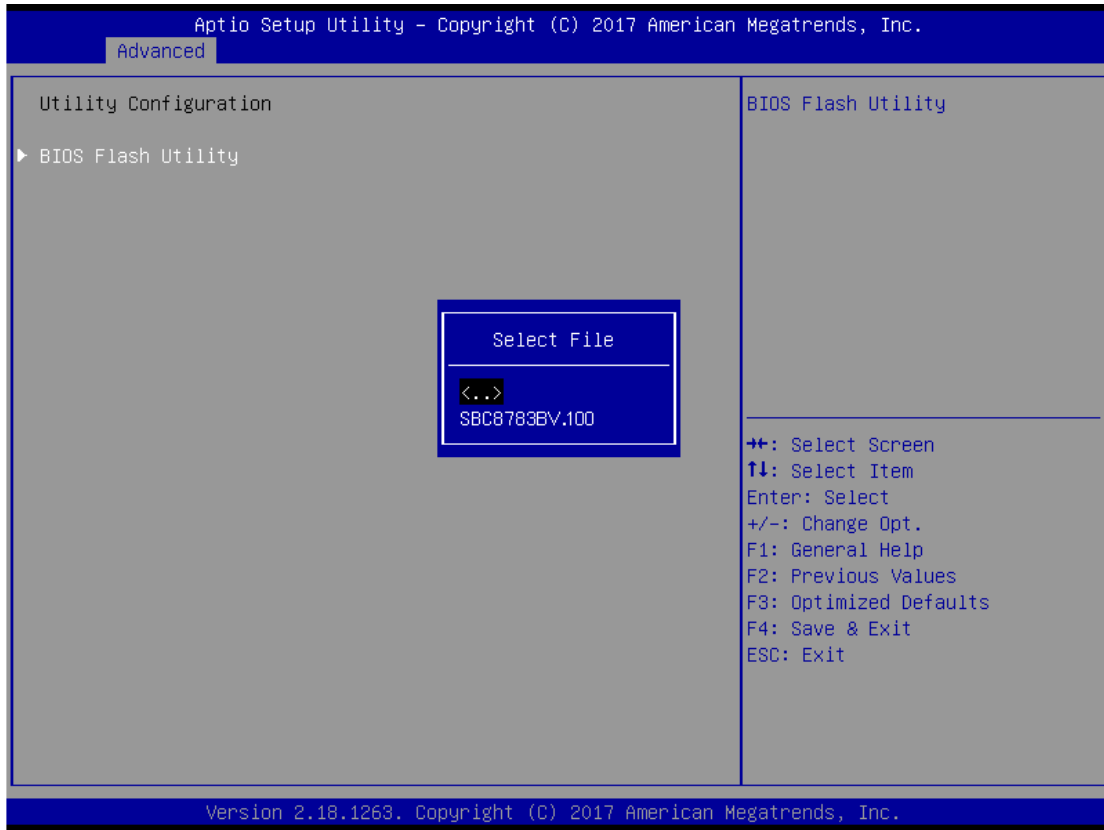

### 3.4 Chipset Feature

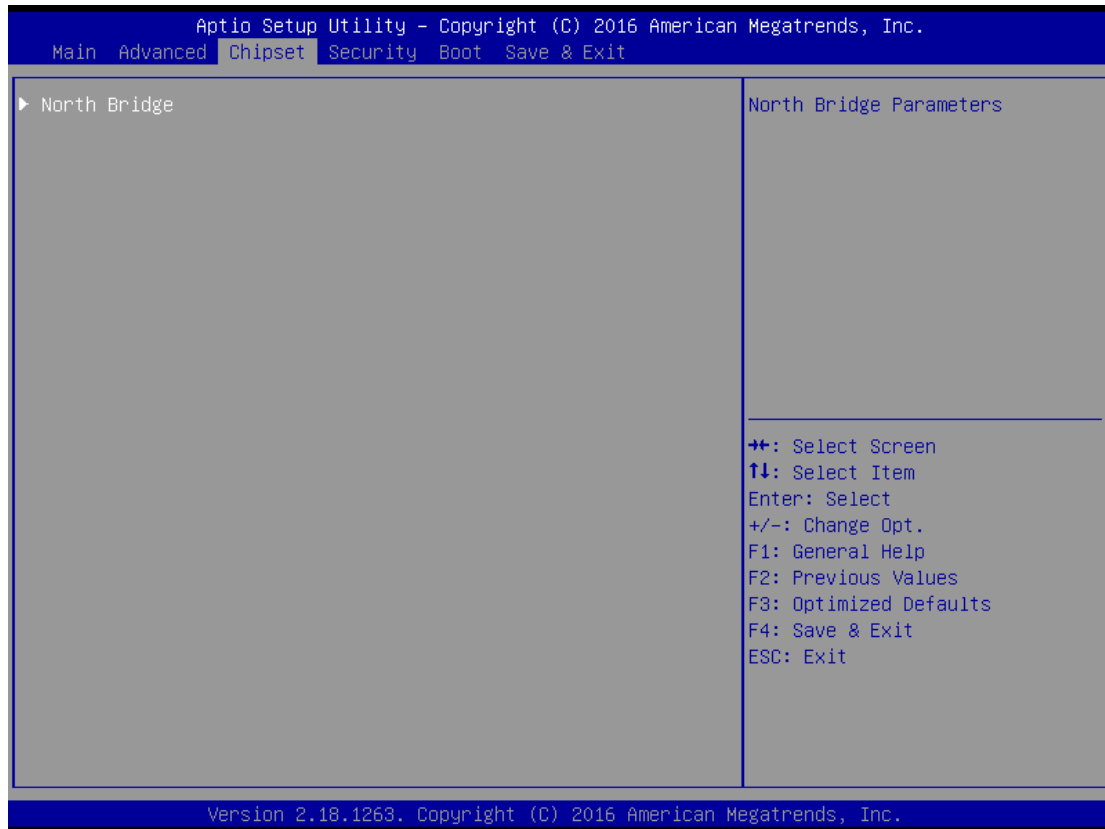



Aptio Setup Utility - Copyright (C) 2016 American Megatrends, Inc.

Chipset

Memory Information	
Total Memory	8192 MB (LPDDR3)
Memory Slot0	8192 MB (LPDDR3)

⚡: Select Screen  
↑↓: Select Item  
Enter: Select  
+/-: Change Opt.  
F1: General Help  
F2: Previous Values  
F3: Optimized Defaults  
F4: Save & Exit  
ESC: Exit

Version 2.18.1263. Copyright (C) 2016 American Megatrends, Inc.

### 3.5 Security

The default setting for Administrator Password is "Not setting passwords".

The Security menu allows users to change the security settings for the system.

You can set the password for both Administrator Password and User Password.

(Please refer below graphics.)

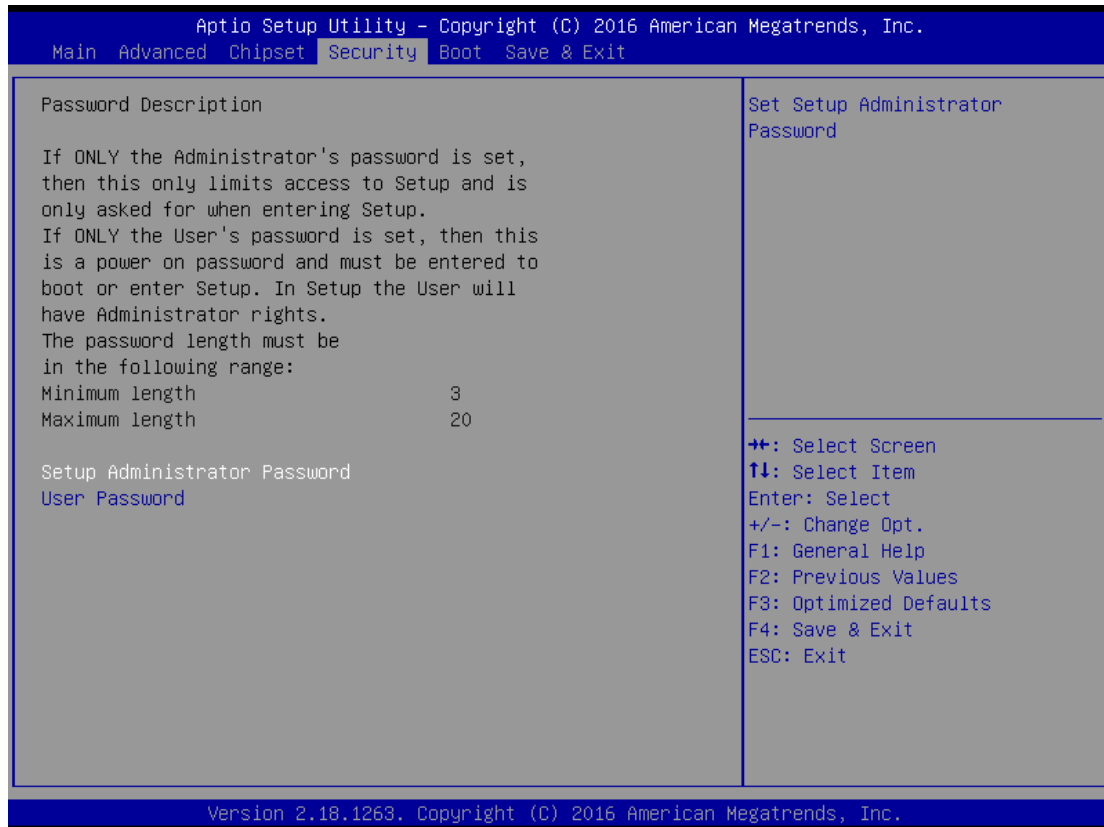

**Note:** The BIOS default has no password, when user created the password, please remember the password number, if users forget password the RMA is the only solution.

### 3.6 Boot Type

The default setting of boot mode is [UEFI],

UEFI – support to boot any UEFI-capable OS and option rom

Legacy - support to boot any legacy-capable OS and option rom

Compatible – customize boot mode of uefi/legacy of specific item

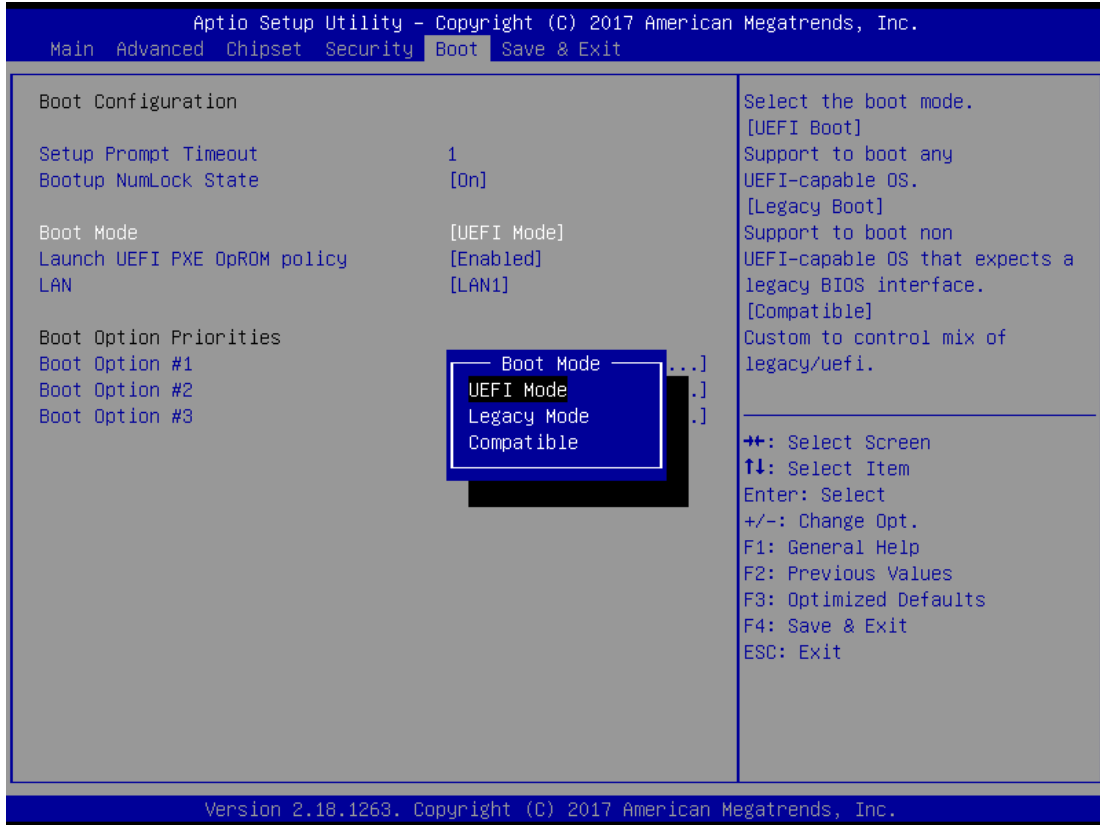

The default setting boot from onboard LAN PxE Rom is [Disabled]

(Please refer below graphics.)

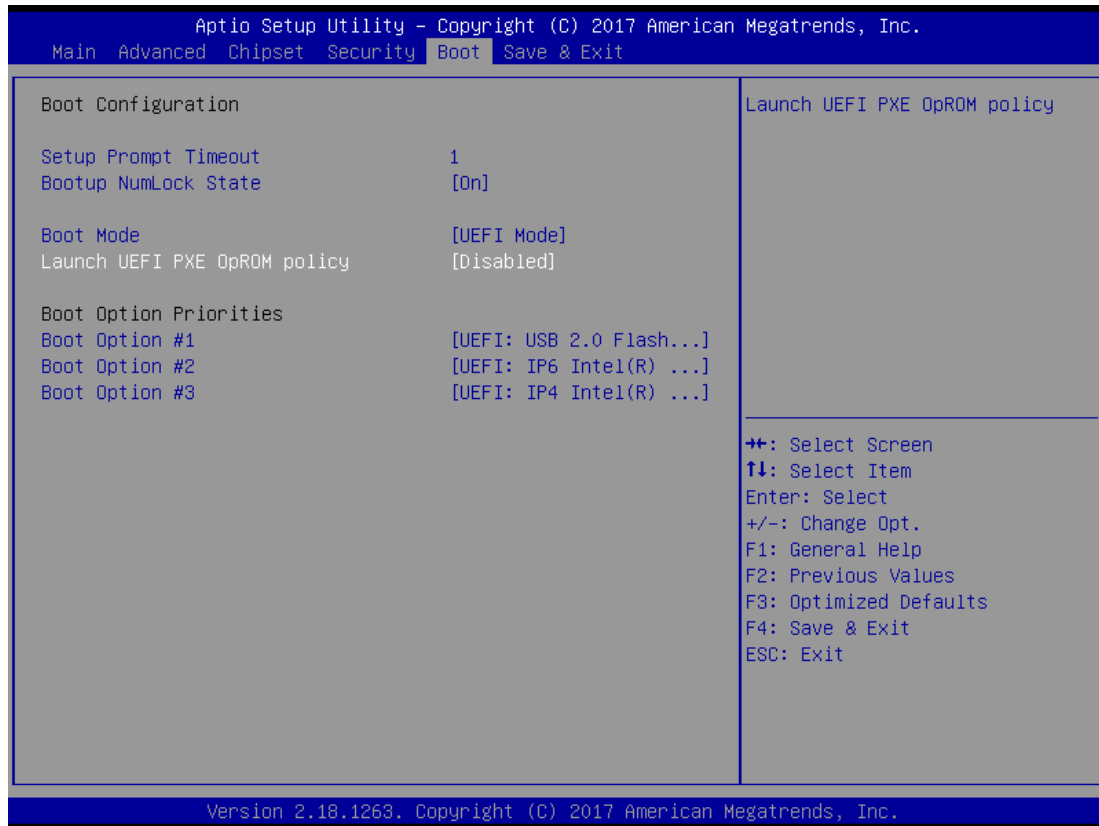

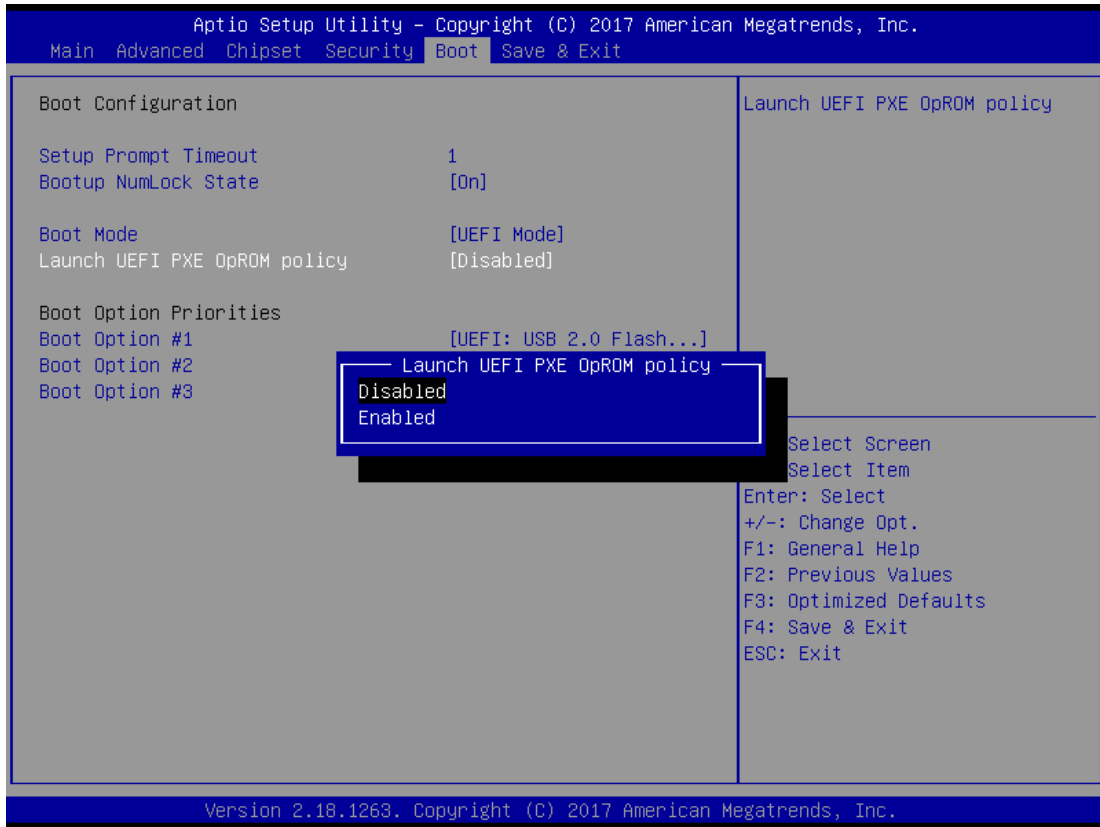

The Boot Option Priorities can select by Boot Option #1, #2..., If user is using a USB Device.  
(Please refer below graphics.)

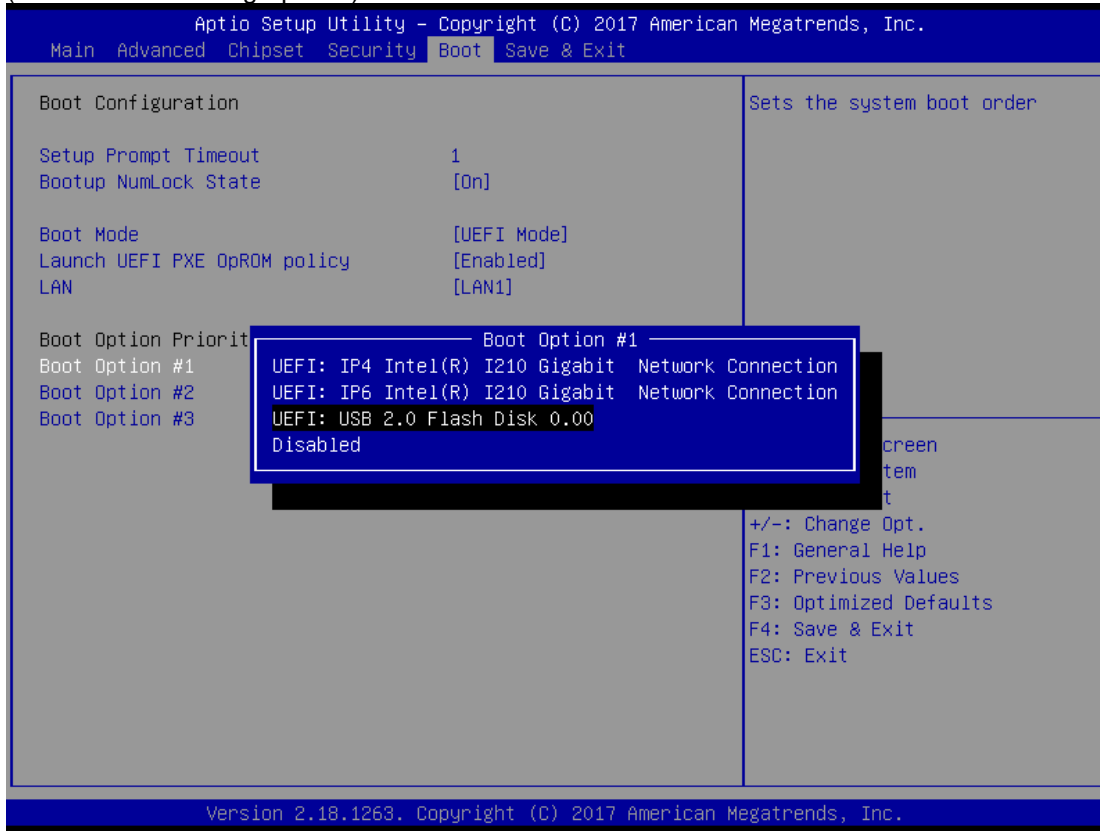







## APPENDIX A WATCHDOG TIMER

### About Watchdog Timer

After the system stops working for a while, it can be auto-reset by the watchdog timer. The integrated watchdog timer can be set up in the system reset mode by program.

### How to Use Watchdog Timer

The following example enables configuration using debug tool.

Enable WDT

↓

Enable configuration:

O 2E 87 ; Un-lock super I/O

O 2E 87

↓

Select logic device:

O 2E 07

O 2F 08

↓

WDT device enable:

O 2E 30

O 2F 01

↓

Set timer unit:

O 2E F0

O 2F 00 ; (00: Sec; 08:Minute)

↓

Set base timer:

O 2E F1

O 2F 0A ; Set reset time (where 0A (hex) = 10sec)

**Disable WDT**



**Enable configuration:**

**O 2E 87 ; Un-lock super I/O**

**O 2E 87**



**Select logic device:**

**O 2E 07**

**O 2F 08**



**WDT device disable:**

**O 2E 30**

**O 2F 00**