



TouchWin Pro software

User manual

Wuxi Xinje Electric Co., Ltd.

Data No. HSC02 20231123EN 1.4

Basic description

- ◆ Thank you for purchasing the Xinje TS series HMI.
- ◆ This manual mainly introduces the use of TouchWin Pro editing software of TS series HMI.
- ◆ Before using the product, please read this manual carefully and use it on the premise of fully understanding its contents.
- ◆ Please deliver this manual to the end user.

Notice to users

- ◆ Only operators with certain electrical knowledge can conduct wiring and other operations on the human-computer interface. If there is any ambiguity, please consult the relevant technical department of the company.
- ◆ The examples listed in the manual and other technical materials are only for users' understanding and reference, and certain actions are not guaranteed.
- ◆ When using HMI with other products, please confirm whether it conforms to relevant specifications and principles.
- ◆ When using the HMI, please confirm whether it meets the requirements and safety by yourself. For the possible machine failure or loss caused by product failure, please set backup and security functions by yourself.
- ◆ Please avoid using HMI in the environment of high radiation and strong magnetic field to avoid interference.

Declaration of responsibility

- ◆ Although the contents in the manual have been carefully checked, errors are inevitable, and we cannot guarantee that all the data are completely consistent.
- ◆ We will often check the contents of the manual and make corrections in the subsequent versions. We welcome your valuable suggestions.
- ◆ The contents introduced in the manual are subject to change without notice.

Related manual

Refer to the following manuals for TS hardware and connection with other communication devices.

- ◆ TS series HMI user manual [hardware]
- ◆ TS series HMI user manual [connection]

WUXI XINJE ELECTRIC CO., LTD. All rights reserved

Without explicit written permission, this material and its contents shall not be copied, transferred or used.

Violators shall be liable for the losses caused. All rights provided in patent license and registration, including utility modules or designs, are reserved.

Aug. 2021

CATALOG

1. TOUCHWIN PRO SOFTWARE.....	1
1-1. TOUCHWIN PRO INSTALLATION.....	1
1-2. TOUCHWIN PRO SOFTWARE UNINSTALLATION	3
2. MAKE A SIMPLE PROGRAM	4
2-1. NEW PROGRAM.....	4
2-2. SCREEN EDIT	6
2-3. OFFLINE SIMULATOR	8
2-4. ONLINE SIMULATION	9
2-5. PROGRAM DOWNLOAD	11
2-5-1. Download overview	11
2-5-2. USB download	12
2-5-3. LAN download	13
2-5-4. Remote download.....	13
2-5-5. U disk download	14
2-6. UPLOAD PROJECT	15
2-7. SCADA PROJECT	18
3. SOFTWARE SCREEN AND WINDOW	23
3-1. SOFTWARE STRUCTURE	23
3-2. PROJECT AREA.....	24
3-2-1. Add.....	24
3-2-2. Copy paste	28
3-2-3. Delete.....	29
3-3. MENU.....	30
3-3-1. File.....	30
3-3-2. Edit.....	48
3-3-3. Parts.....	50
3-3-4. Mapping.....	51
3-3-5. Tool	51
3-3-6. View	56
3-3-7. Help	56
3-4. TOOL BAR.....	57
3-5. SCREEN EDITING AREA	58
3-6. FUNCTION AREA	59
3-7. COMPONENT AREA	59
3-8. OUTPUT WINDOW	59
3-9. STATUS AREA.....	60
3-10. SYSTEM SETTING.....	61
3-10-1. Parameter	61
3-10-2. Monitor	62
3-10-3. Interaction.....	63

3-10-4. User permission	64
3-10-5. Clock.....	68
3-10-6. Device.....	70
3-10-7. Printer.....	71
3-10-8. Project.....	72
4. COMPONENTS.....	73
4-1. DRAWING	73
4-1-1. Straight line	73
4-1-2. Circular.....	76
4-1-3. Rectangle	78
4-1-4. Arc.....	80
4-1-5. Polygon.....	82
4-1-6. Form	84
4-1-7. Scale.....	86
4-1-8. QR code	88
4-1-9. Picture.....	91
4-1-10. Dynamic picture.....	93
4-1-11. Translating animation	97
4-1-12. Function canvas.....	99
4-2. PARTS.....	104
4-2-1. Static text	104
4-2-2. Dynamic text.....	106
4-2-3. Numeric input	109
4-2-4. Numerical display.....	121
4-2-5. Character input.....	125
4-2-6. Character display	130
4-2-7. Chinese input	132
4-2-8. Chinese display.....	137
4-2-9. Indicator light.....	140
4-2-10. Indicator button	142
4-2-11. Multi-state indicator	148
4-2-12. Key.....	153
4-2-13. Multi state key.....	157
4-2-14. Character key.....	161
4-2-15. Function key.....	164
4-2-16. Function domain.....	181
4-2-17. Sliding input.....	194
4-2-18. Drop down menu.....	200
4-2-19. File browse	204
4-3. DEVICE.....	207
4-3-1. Time	207
4-3-2. Date	209
4-3-3. Pipe.....	210
4-3-4. Dashboard	213
4-3-5. Electric machinery.....	218
4-3-6. Bar chart.....	220

4-3-7. Buzzer	225
4-3-8. Backlight.....	228
4-3-9. Fan.....	230
4-3-10. Agitator.....	233
4-3-11. Water pump.....	236
4-3-12. Valve.....	239
4-4. ALARM.....	242
4-4-1. Alarm entry.....	242
4-4-2. Alarm display.....	248
4-4-3. Alarm bar.....	256
4-5. DATA PROCESSING.....	260
4-5-1. Data sampling.....	260
4-5-2. Trend map.....	266
4-5-3. XY line chart.....	274
4-5-4. XY trend chart.....	279
4-5-5. Report form.....	284
4-5-6. Pie chart.....	291
4-5-7. Data table.....	294
4-6. RECIPE.....	300
4-6-1. Recipe edit.....	300
4-6-2. Recipe table.....	302
4-6-3. Recipe transfer.....	307
4-6-4. Recipe transfer application.....	312
4-6-5. Event button.....	317
4-7. OPERATION RECORD.....	321
4-7-1. Operation record setting.....	321
4-7-2. Operation record display.....	324
4-8. HIRE PURCHASE.....	329
4-8-1. Static installment payment.....	329
4-8-2. Dynamic installment payment.....	331
4-9. SPECIAL COMPONENT.....	335
4-9-1. Timer.....	335
4-9-2. Scrolling text.....	339
4-9-3. Camera.....	341
5. LIBRARY DESCRIPTION.....	346
5-1. Label multilingual.....	346
5-1-1. Label multilingual introduction.....	346
5-1-2. Label library.....	347
5-1-3. Label table.....	349
5-1-4. Examples of Multilingual Usage of Labels.....	350
5-2. Address label library.....	354
5-2-1. HMI internal address.....	354
5-2-2. System label.....	355
5-2-3. Custom label.....	366
5-2-4. Equipment label.....	370
5-3. Resource material library.....	370

5-4. Audio resource library	372
6. FUNCTION BLOCK.....	374
6-1. FUNCTION BLOCK INTRODUCTION	374
6-1-1. Function block operating conditions	374
6-1-2. Build a function block.....	374
6-1-3. Function block compilation	375
6-1-4. Run the function block	377
6-2. FUNCTION BLOCK EXPLANATION	380
6-2-1. Writing method.....	380
6-2-2. Function type	380
6-2-3. Predefined data types.....	381
6-2-4. Predefined macro instructions	382
6-2-5. API function.....	382
6-3. PROJECT EXAMPLE	393
6-3-1. Data compare	393
6-3-2. Clear the data block.....	396
6-3-3. Four arithmetic operations of floating point	398
6-3-4. Data type cast	400
7. HMI SYSTEM SETTINGS.....	403
7-1. SYSTEM SETTING INTRODUCTION	403
7-2. KEYBOARD.....	403
7-3. DEVICE INFORMATION	404
7-4. SETTING	404
7-4-1. Name.....	405
7-4-2. Password.....	406
7-4-3. Network.....	407
7-4-4. Time	407
7-4-5. VNC	408
7-4-6. System	408
7-5. SYSTEM MENU.....	409
7-5-1. Native information	409
7-5-2. Time setting.....	410
7-5-3. HMI IP setting	411
7-5-4. Password setting.....	411
7-5-5. Informatization settings	412
8. INFORMATIONIZATION SETTINGS	416
8-1. INFORMATION CONFIGURATION LOGIN	416
8-2. STATE INFORMATION	419
8-3. NETWORKING SETTINGS	420
8-3-1. TouchwinPro software configuration.....	420
8-3-2. HMI (lower computer) configuration	422
8-3-3. User project configuration.....	422
8-4. REMOTE SETTINGS (VNC).....	423
8-4-1. TouchwinPro software connection.....	423

8-4-2. Boxmanger software connection	424
8-4-3. PC connection.....	425
8-4-4. Mobile connection	427
8-5. ONLINE TRANSMISSION	429
8-5-1. Serial port transparent transmission	429
8-5-2. VPN transparent transmission	431
8-6. DATA RELEASE	433
8-6-1. Data release configuration	433
8-6-2. Xinje cloud server	436
8-6-3. Custom MQTT server.....	441
8-6-4. Aliyun server.....	442
8-6-5. MQTT Data Explanation	449

1. TouchWin Pro software

1-1. TouchWin Pro installation

1. PC hardware configuration

CPU above INTEL Pentium II, More than 64MB memory. Hard disk with more than 2.5GB and at least 1GB of disk space. 32-bit true color display with resolution above 800 x 600.

2. Operation system

Windows 10/windows11.

3. Installation steps

- (1) Find "setup. exe" in the installation file package and right click to run as an administrator. A dialog box as shown below appears. Select the language to install: (Note: Please close the anti-virus software during installation!)

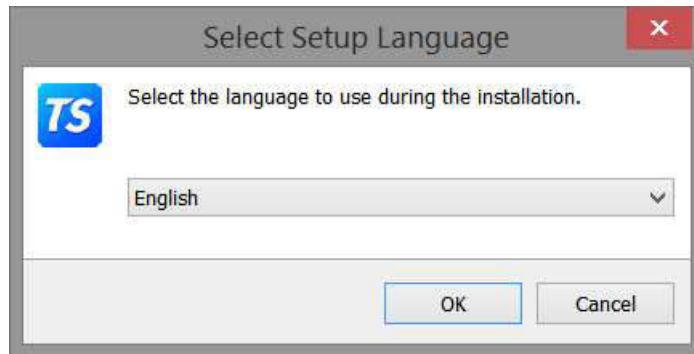

- (2) Click OK, select "I accept the agreement", click next.

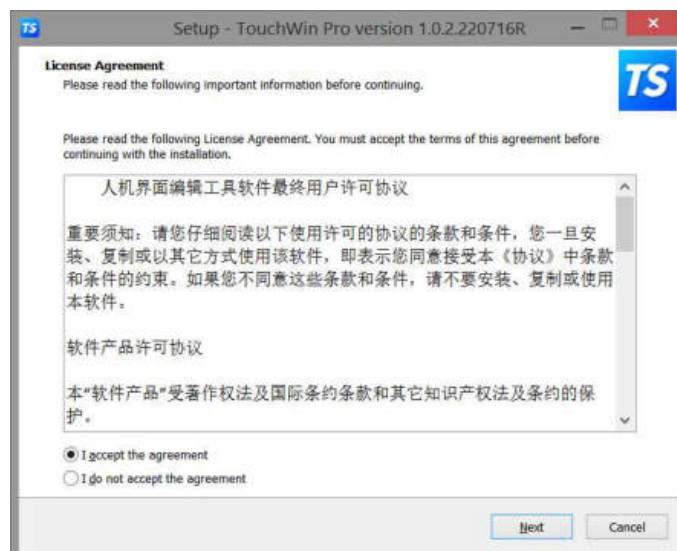

- (3) Select the software installation folder. It is recommended to install the software on a non system disk and in the English path. (%!/@ and other special characters cannot exist in the installation path name)

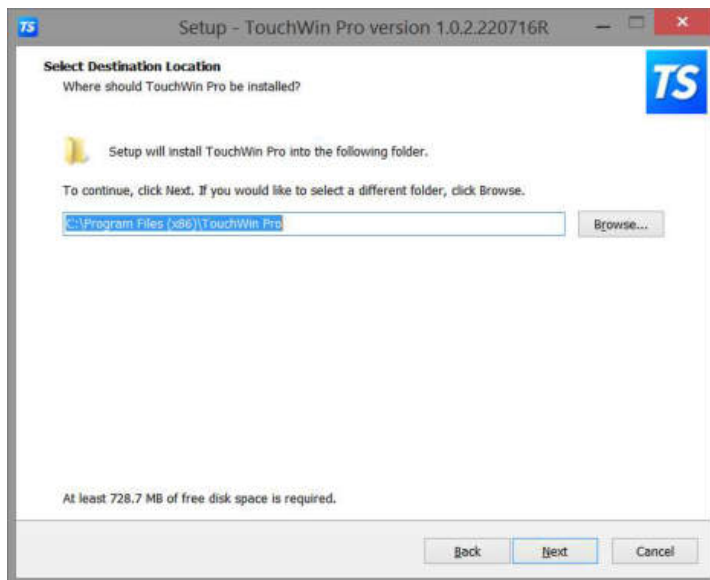

(4) Choose whether to add shortcuts.

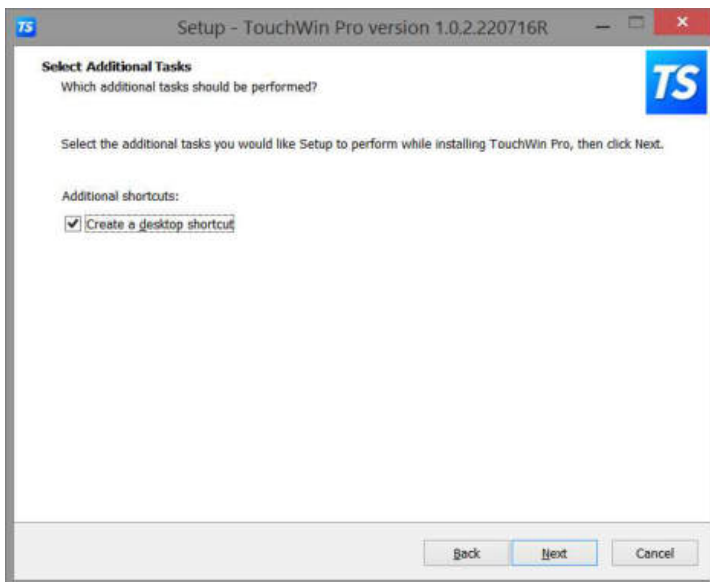

(5) Click Install to finish the installation.

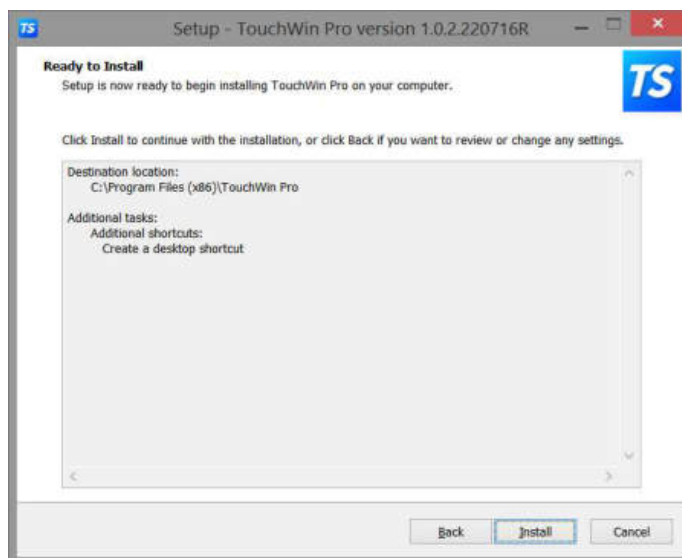

To install two or more different versions of editing software on the computer, you must select different

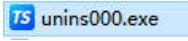

installation paths, otherwise overwriting the installation will cause the software to run abnormally or even fail to run. After installation is completed, if you modify the software installation directory, the directory name cannot contain%//@ Wait for special characters.

1-2. TouchWin Pro software uninstallation

1. Find out “unins000.exe”  in the software installation folder, double click it to uninstall the software.



2. Click Yes to uninstall.
3. After the software uninstallation is completed, it will automatically exit the uninstallation program, and finally delete the installation directory folder by manual.

名称	修改日期	类型	大小
 HMI	2021/8/28 8:55	文件夹	
 Log	2021/8/27 15:13	文件夹	
 Temp	2021/8/27 17:19	文件夹	

2. Make a simple program

TouchWin Pro editing software is simple and fast, and provides an ideal editing platform for beginners or users with a certain foundation. This chapter introduces the use of HMI editing software through a simple project production.



Please confirm the model of HMI and the type of communication equipment before making the program, which is the prerequisite for the normal operation of the screen program and equipment

2-1. New program



1. Click  to build a new program.
2. Select correct HMI model, for example TS3-700-E. Click next page.

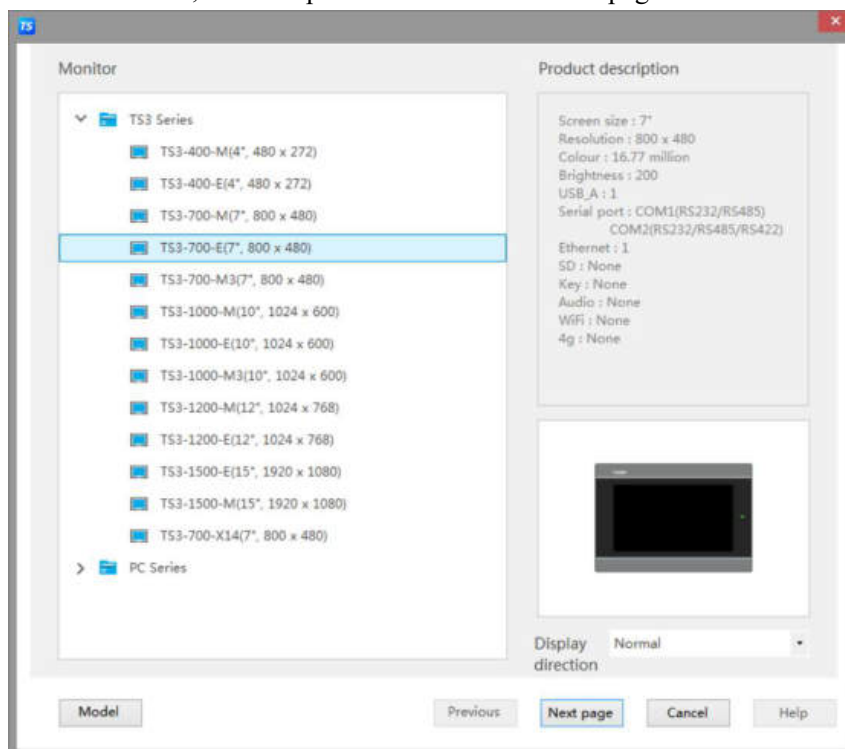

3. Set the COM port, the COM port has no equipment by default. You need to select the PLC brand through the pull-down menu. After selecting the correct PLC type in the list, click the "New Equipment" button, and set the equipment name and its communication parameters in the pop-up window

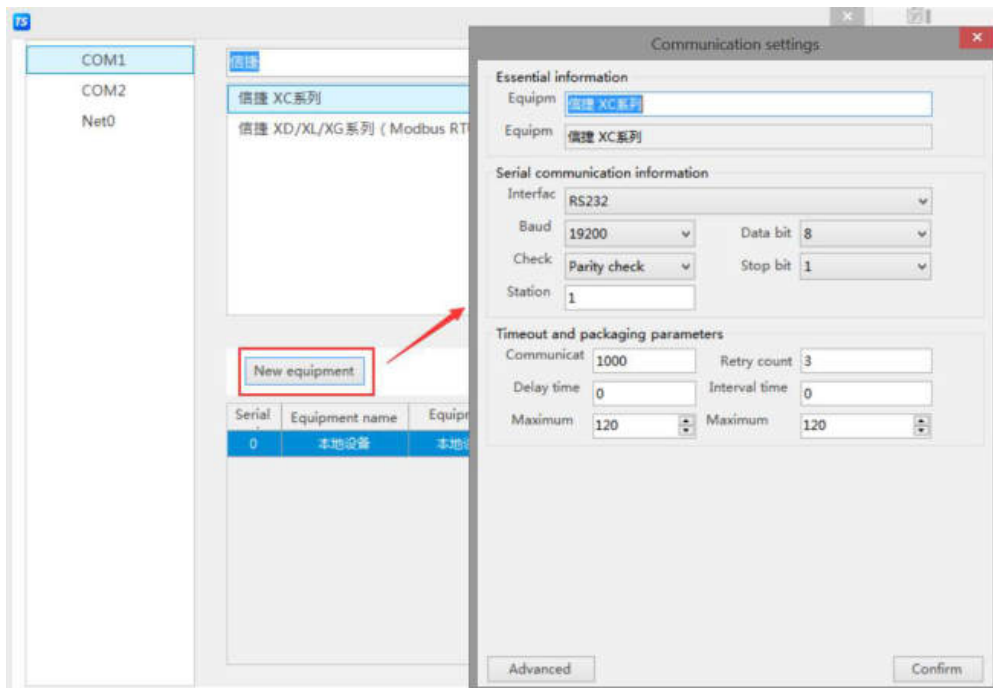

4. Set the Ethernet port (Net0), select the PLC brand through the pull-down menu, select the correct PLC type in the list, click the "New equipment" button, and set the communication parameters such as device name and IP address in the pop-up window.

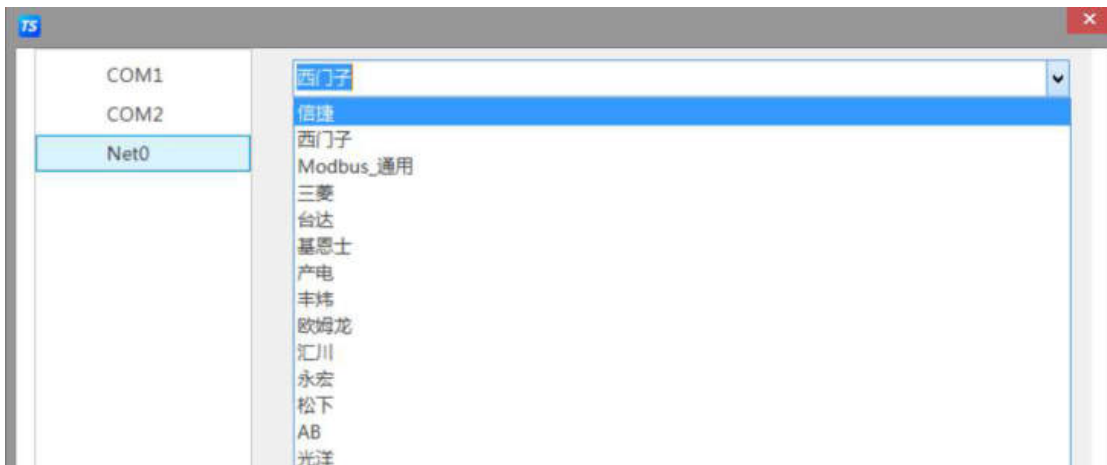

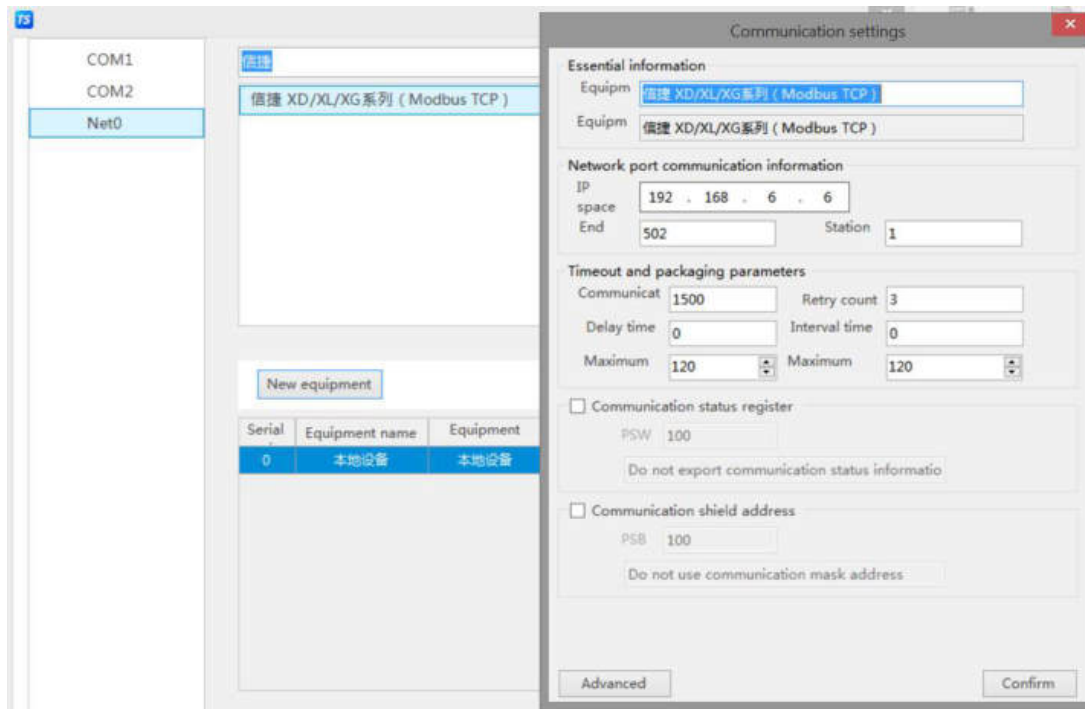

Click the "Set native IP" button, and set the HMI native IP address parameters in the pop-up window (you can choose to automatically obtain the IP address or customize the IP address)

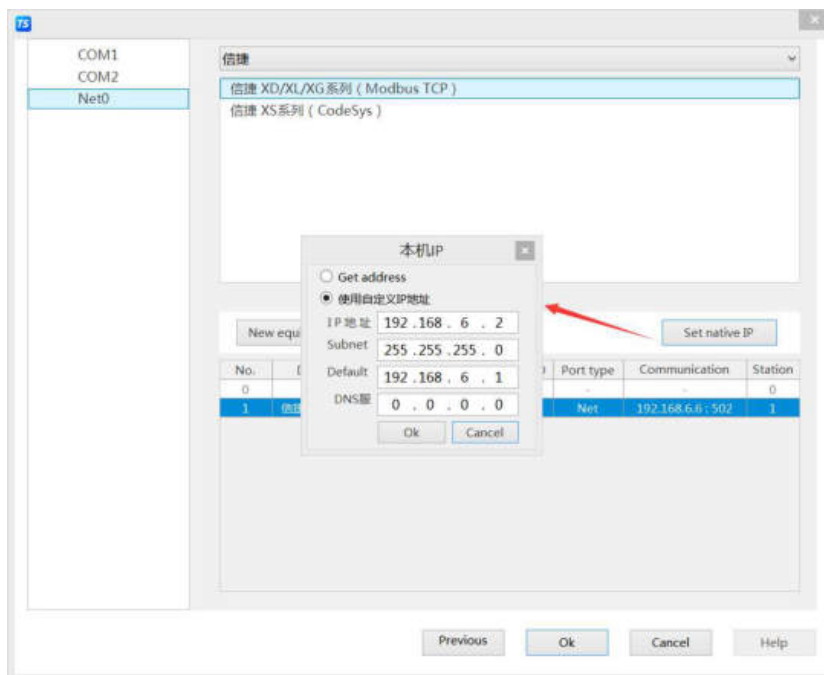

5. Click ok to finish the building.



- (1) TouchWin Pro software cannot support TG series HMI.
- (2) -E series HMI can support Ethernet devices.

2-2. Screen edit

Realize the reverse operation of digital value Y0, and display the output status of Y0 through the indicator on

the HMI.

1. Make the button



Click the menu Parts/key/key or key icon in control window. Click on the editing screen to set its properties in the pop-up properties dialog box.

■ Basic properties

Write address: set to Y0.

Action: set to reverse.

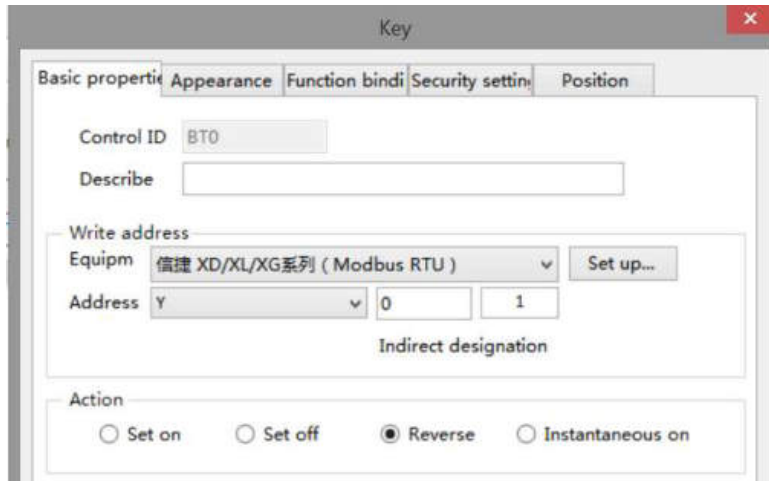

Text: enter reverse Y0.

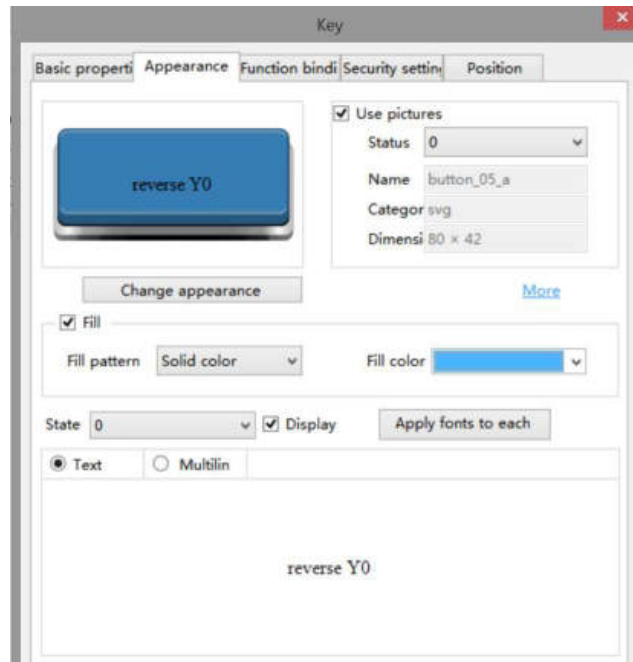

You can click "Change appearance" to enter the resource material library of the system and select an appropriate appearance, or click "More" to select a custom picture as the appearance of the component.

2. Indicator light



Click the menu Parts/key/indicator light or click the indicator icon in control window. Click on the editing screen to set its properties in the pop-up properties dialog box.

■ Basic properties

Read address: set to Y0.

Logic: set to positive logic.

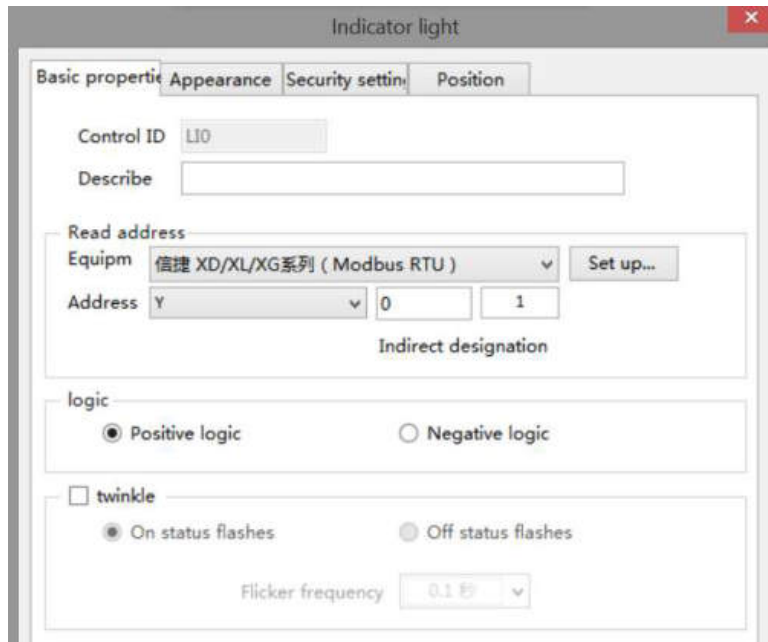

■ Appearance

Set the appearance display of its ON status and OFF status respectively.



2-3. Offline simulator

In order to facilitate the user to debug and edit the screen, the actual operation of HMI and PLC can be simulated on the computer (no need to connect PLC).

1. Click the menu File/offline simulator or offline simulator icon



2. The following prompt window will pop up in the interface, and it is recommended to select all of them, otherwise the simulation will be abnormal.

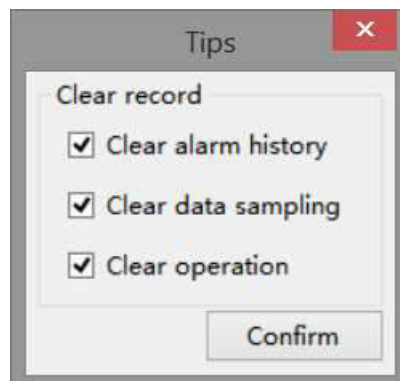

3. Click the "Reverse Operation" button to directly observe the output state of Y0 through the indicator light



ON status



OFF status

2-4. Online simulation

Simulate the actual operation of HMI and PLC on the computer to realize the monitoring function of the lower computer equipment (PLC must be connected to the computer, and the effective operation time of online simulation is within 2 hours).

1. Click the menu File/online simulation or online simulation icon  in control window.

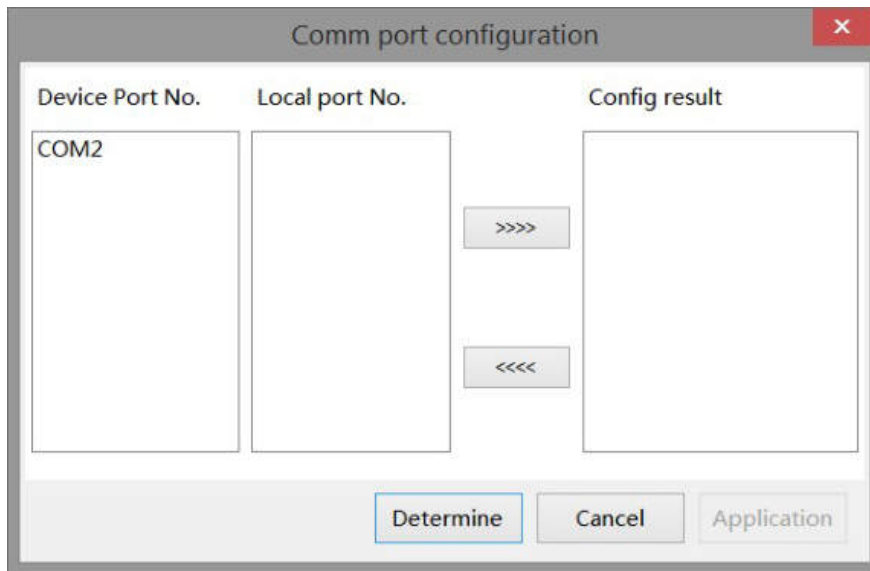

2. At this time, you need to configure the port. Configure the device port with the local port. First click to select the device port number, then click to select the local port number, and then click the middle button. The right side will display the configuration results.

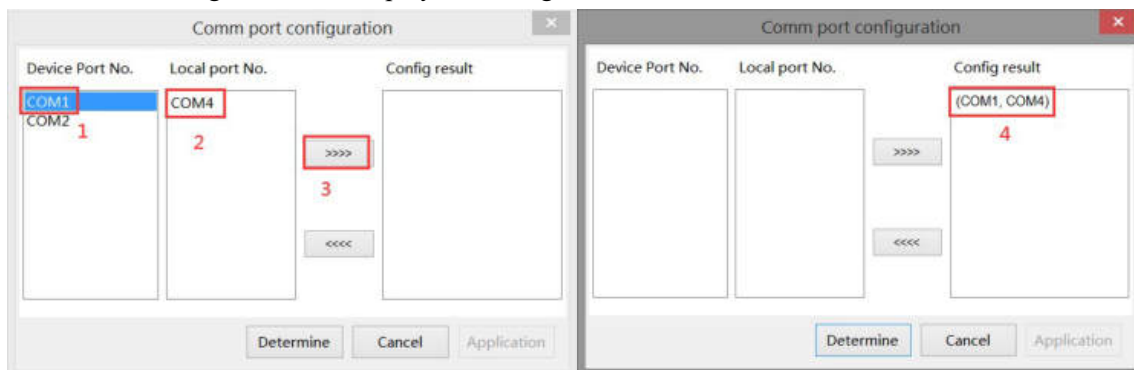

Device port number	Select the HMI port number, that is, the COM port selected when adding a device for a new project, which can be viewed by clicking "File/System Settings - Equipment"
Local port number	Select the port number of the PLC connected to the computer, which can be viewed through the computer device manager

Configuration result	Display port configuration results
----------------------	------------------------------------

- The following prompt window will pop up in the interface, and it is recommended to select all of them, otherwise the simulation will be abnormal.

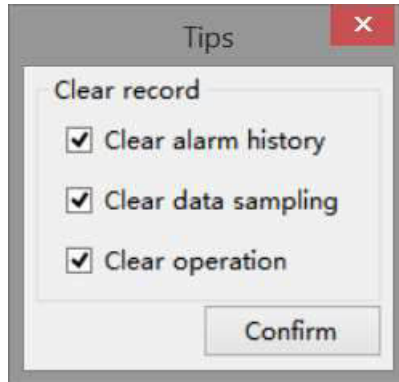

- After the above operations are completed, click "OK" to enter the online simulation screen, which can realize the function of the computer monitoring the PLC. In the figure, Y0 output is achieved through reverse operation, as shown in the indicator light



If the prompt window of "communication timeout" appears on the online simulation interface, first check whether the port is correctly selected and configured, and then check whether the serial port in the computer is occupied by other software.

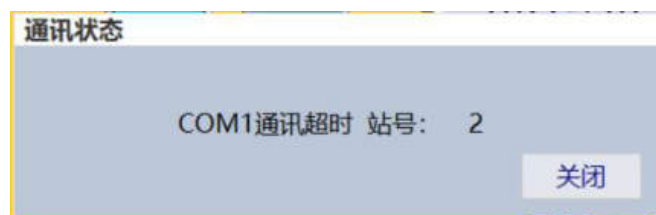

2-5. Program download

2-5-1. Download overview

There are three download methods for TS series HMI: USB, LAN and Remote. LAN and Remote require (- E) series models.

The project downloaded by default does not support upload. If you need to support project upload, please select "Allow project upload" on the download page. Then, you can set the "upload password".

Click the menu File/download or the download icon  to show the following window.

Communication settings	Set the download connection mode and corresponding parameter settings
Connection	Refers to the way to connect the HMI. You can select USB, LAN and remote
Download password	To set the download password of the project, it must be consistent with the password set in the HMI, otherwise it will not be downloaded. The default download password is 123456. For the modification of the password in the HMI, refer to chapter 7-2 Password
Allow project upload	Set whether the current project can be uploaded
Upload password	When Allow Project Upload is selected, you can choose to set the upload password
User defined boot screen	After checking, click "Browse", and select the file as the HMI boot loading screen

	(the current version only supports images with 800 * 480 pixels and BMP format)
Synchronize PC time	The time information of the computer is synchronously downloaded to the HMI to synchronize the HMI clock with the computer
Hide menu system	There is a system menu at the lower right corner of the HMI by default, here you can set whether the menu is displayed
Enable installment	This download will enable the installment function
Clear alarm record	This download will delete the alarm information stored in HMI
Clear operation	This download will delete the operation record information stored in HMI
Clear data acquisition	This download will delete the data collection information stored in HMI
Overwrite recipe data	This download will overwrite the original recipe data in HMI with the recipe data set in the current project
Download fonts to	Download the fonts of the computer to the HMI to synchronize the HMI fonts with the computer
Clear PFW data	This download will delete PFW data stored in HMI
Download	Execute the download operation, and download the project to the HMI
Upload	Read the project in HMI to the computer, and check "Allow project upload" is selected when downloading the project in HMI, otherwise it will prompt that the project does not support upload
Close	Close the window

2-5-2. USB download

When USB connection mode is selected, it can be used after successful connection, and no other parameter setting is required.

(Note: TS5 series HV2 and above versions are not supported);

USB refresh: Identify the currently available USB. If no USB is identified, the "communication" cannot be clicked.

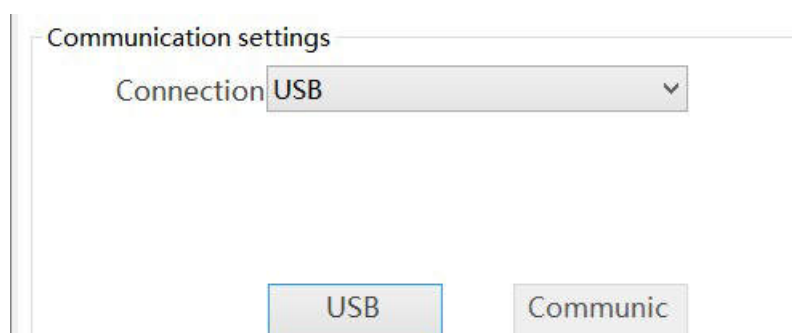

Communication: It is used to test whether the HMI is successfully connected to the computer. After clicking, the connection status will be displayed on the right side of the button, including "connection succeeded, connection failed, connection timeout.

2-5-3. LAN download

When the LAN connection mode is selected, IP and ID settings will be displayed below. You need to enter the correct IP or ID address to download the program.

(Note: - E model supported, you need to first change the network adapter IP of the computer to a manually specified IP, and it should be in the same network segment as the HMI's IP);



Device IP discovery: Input the IP address of the connected HMI, or select the last input address through the drop-down box

Device ID lookup: Input the ID address of the connected HMI, or select the last input address through the drop-down box. The touch screen ID can be viewed on the label on the back of the HMI.

Scan IP: When the IP address is uncertain or multiple HMIs are connected, click this button to scan the device IP connected to the computer, select the IP address to download from the scanned IP addresses, and click it to pop up the window below.

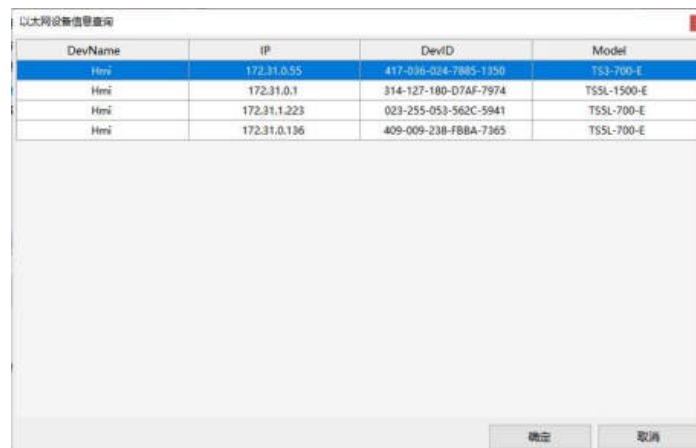

DevName	IP	DevID	Model
Hmi	172.31.0.55	417-016-024-7805-1350	TSS3-700-E
Hmi	172.31.0.1	314-127-180-D7AF-7974	TSSL-1500-E
Hmi	172.31.1.223	023-255-053-562C-5941	TSSL-700-E
Hmi	172.31.0.136	409-009-238-FB8A-7365	TSSL-700-E

Communication: It is used to test whether the touch screen is successfully connected to the computer. After clicking, the connection success, connection failure or connection timeout will be displayed on the right side of the button.

2-5-4. Remote download

When remote connection is selected, the HMI needs to be connected to the network, and the correct ID number and password need to be input, as shown in the following figure (not supported in the current version).

(Note: TS5 or above models are required and maintain network connection. Remote system updates are sensitive operations and should be operated with caution. When network connection is abnormal, it may cause downloading failure or even system update failure. HMI needs to be updated on the local area network to recover.);

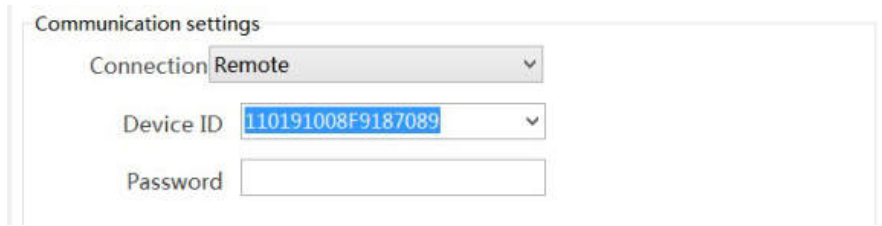

Device ID: Input the ID address of the connected HMI, or select the last input address through the drop-down box. The HMI ID can be viewed on the label on the back of the product.

Password: User defined remote connection password.

2-5-5. U disk download

When selecting a USB drive to download, it is necessary to prepare a USB drive and generate a USB drive file through the upper computer. Then, select and import the download from the lower computer;

USB file generation: Export and store the project as .dat file, with a customizable file name but .dat suffix. Copy the generated file to the root directory of the USB drive and connect it to the HMI. The file can be directly downloaded to the TS series HMI.

The operation steps are as follows:

1. Open the "File" menu, select "Generate USB Flash disk File", and a dialog box for selecting the save path will appear, as shown in the following figure. Click "...", select the path to save in the pop-up window, enter the name of the USB drive project file to be saved, and note that the file save type must be dat.
2. After selecting the path, select the HMI hardware version number to download, and then click the "Export" button.

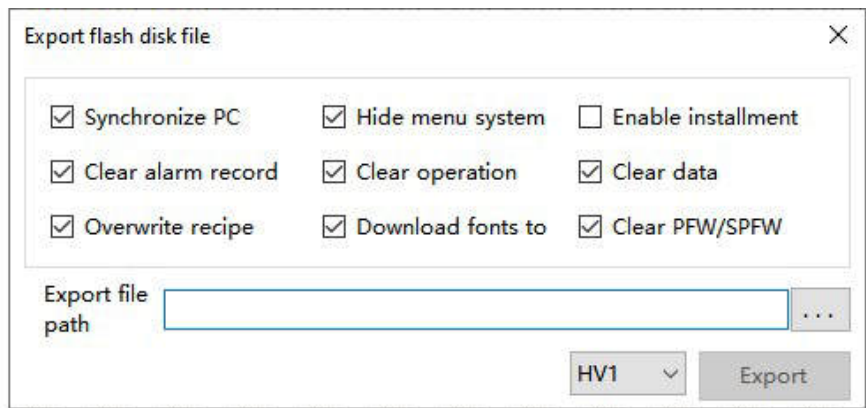

Note: HV1 is an old version, HV2 is a new version. The old version of the HMI can only select HV1, and the new version of the HMI can only select HV2. Otherwise, it will prompt that the firmware is incorrect. Please refer to 7-3 for the current hardware version of the HMI.

3. If the export is successful, a prompt will appear as shown in the following figure, and a file must be generated in the save path. The file type must be .dat (do not modify the file suffix). Copy the file to the root directory of the USB drive for later use.

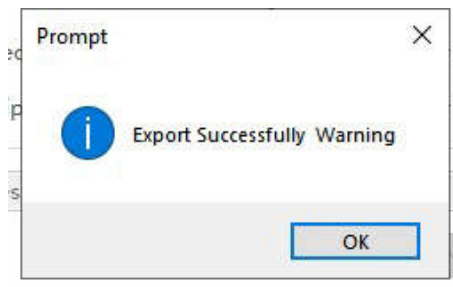

4. Insert the USB drive into the USB port of the HMI, and a "USB Drive Update" pop-up window will pop up in the upper left corner of the HMI. Click "Update Hmi Project" to pop up a file selection window, as shown in the following figure.
5. Select the project to be imported from the list, click the "OK" button in the bottom right corner, and the system will automatically execute the import of the project file. The progress bar of the imported project will be displayed on the screen. After the import is completed, remove the USB flash drive.

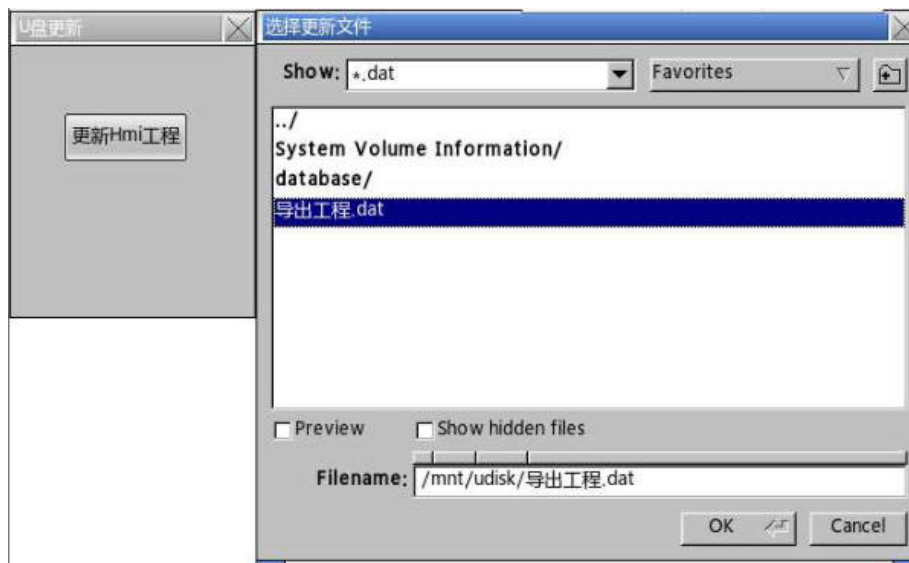

The "Allow Project Upload" setting on the software download interface after updating the project using a USB drive does not take effect, meaning that the updated project through the USB drive is not allowed to be uploaded.

2-6. Upload project

The HMI supports the upload function of engineering data, which is convenient for data resource management.

Click the menu File/download or download icon , click the "Upload" button at the bottom of the pop-up window. The precondition for uploading is that "Allow Project Upload" is selected when downloading the project to the HMI. If the upload password is set, you need to enter the correct password to upload the project successfully.



Password input range: 1-8 digits and characters.

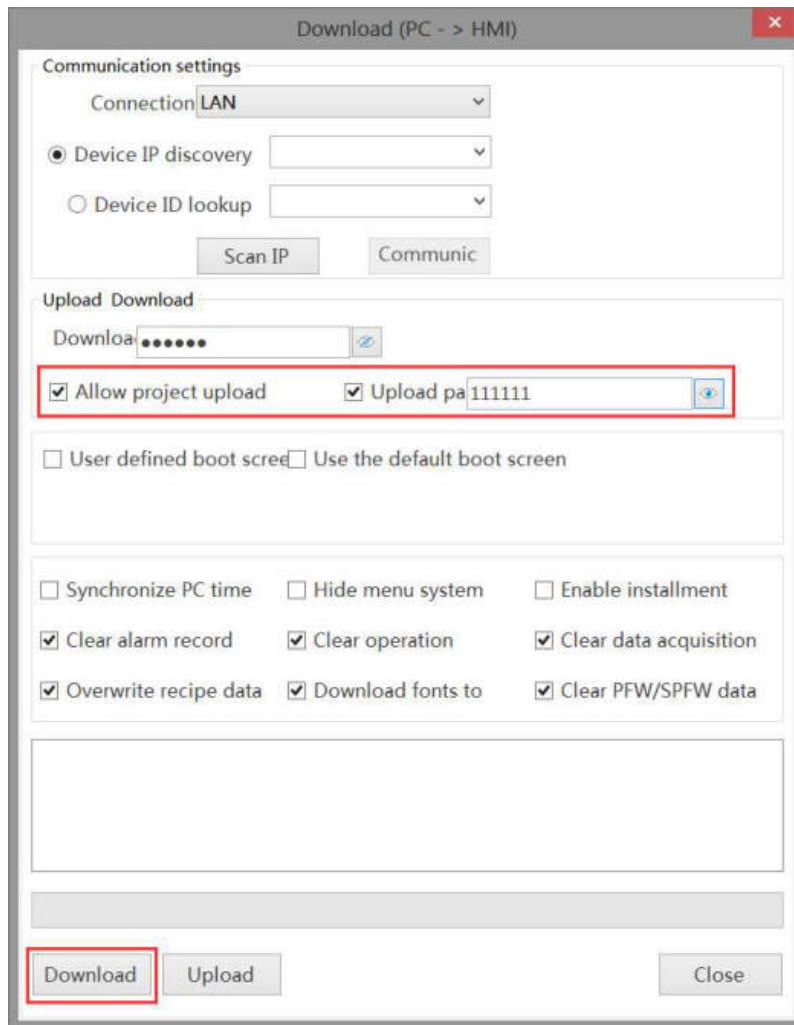

When the download is successful, the steps to upload the project are as follows:

1. Complete steps 1~3 as shown in the figure below

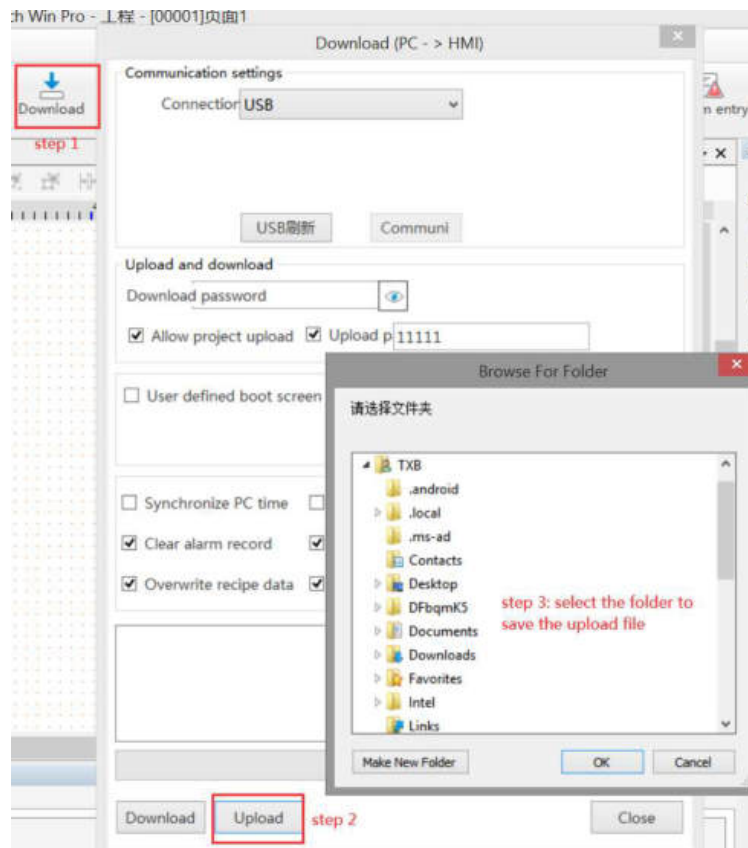

2. Click OK to pop up the password input dialog box. Enter the upload password set during download, and click OK. (If the upload password is not selected, this step is not available)

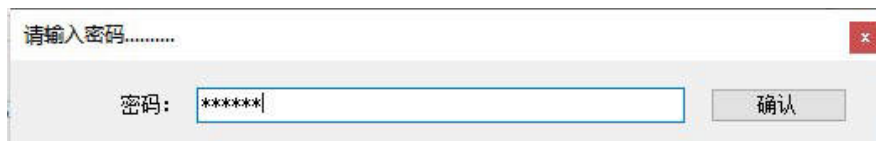

3. After clicking OK, the progress bar of file upload will be displayed, and the words "upload succeeded" will be displayed.



4. Open the path saved by the upload project, and you can see a Hmi.xjp file



If Allow Project Upload is not selected, a window prompt of "No Upload" will appear when clicking upload.

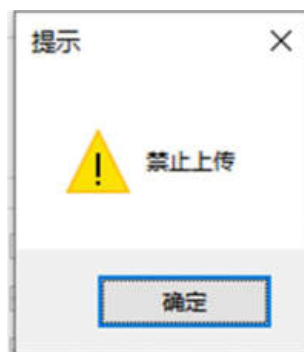

2-7. SCADA project

The SCADA project needs to be used in conjunction with the secret dog Autowin Pro.



1. Open the editing software, click the "New" icon on the toolbar or "New" under the "File" menu.
2. Select the TS-PC series and select the corresponding resolution based on the display.

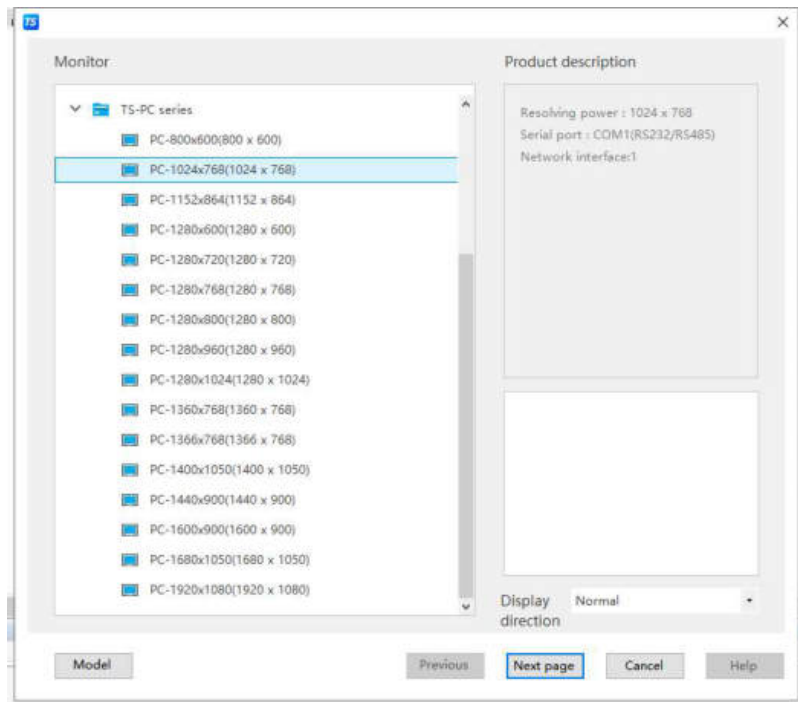

- Set the COM port. By default, there is no device for the COM port. You need to select the PLC brand through the drop-down menu, select the correct PLC type in the list, and click the "New Equipment" button. In the pop-up window, set the device name and its communication parameters.

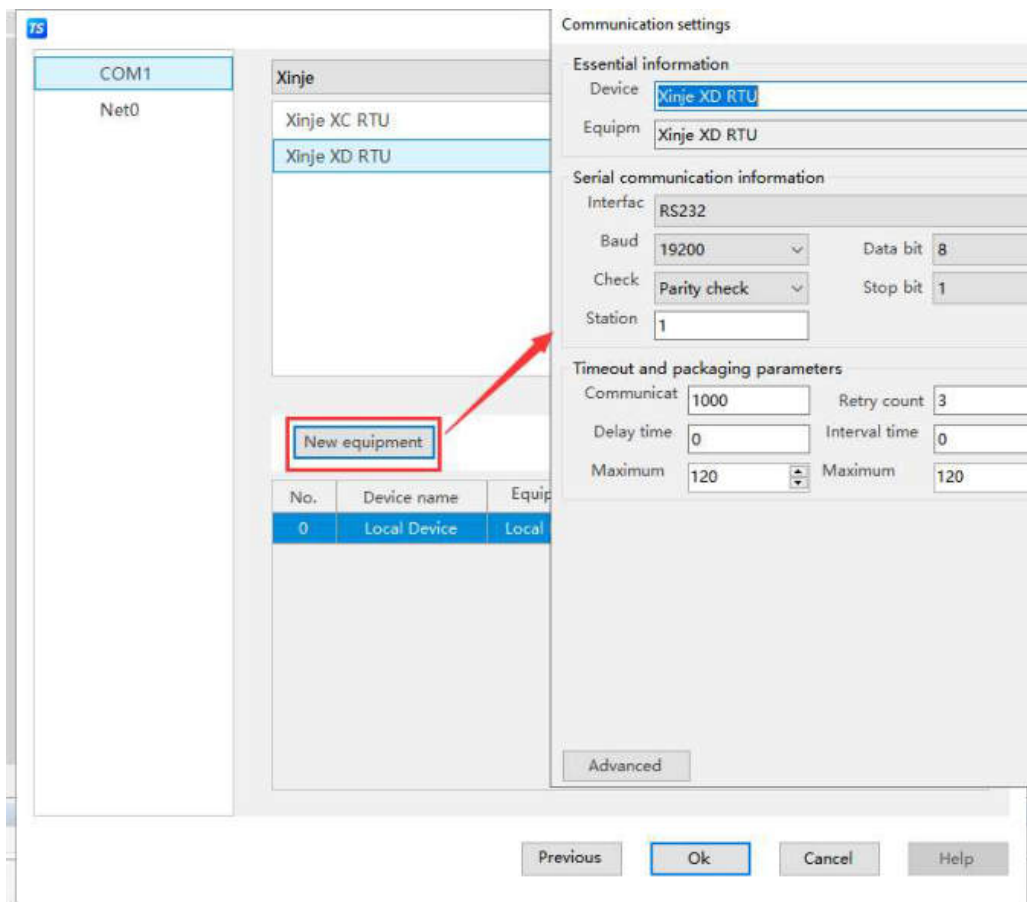

- Set the Ethernet port, select the PLC brand through the drop-down menu, select the correct PLC type in the list, and click the "New Equipment" button. In the pop-up window, set communication parameters such as

device name and IP address.

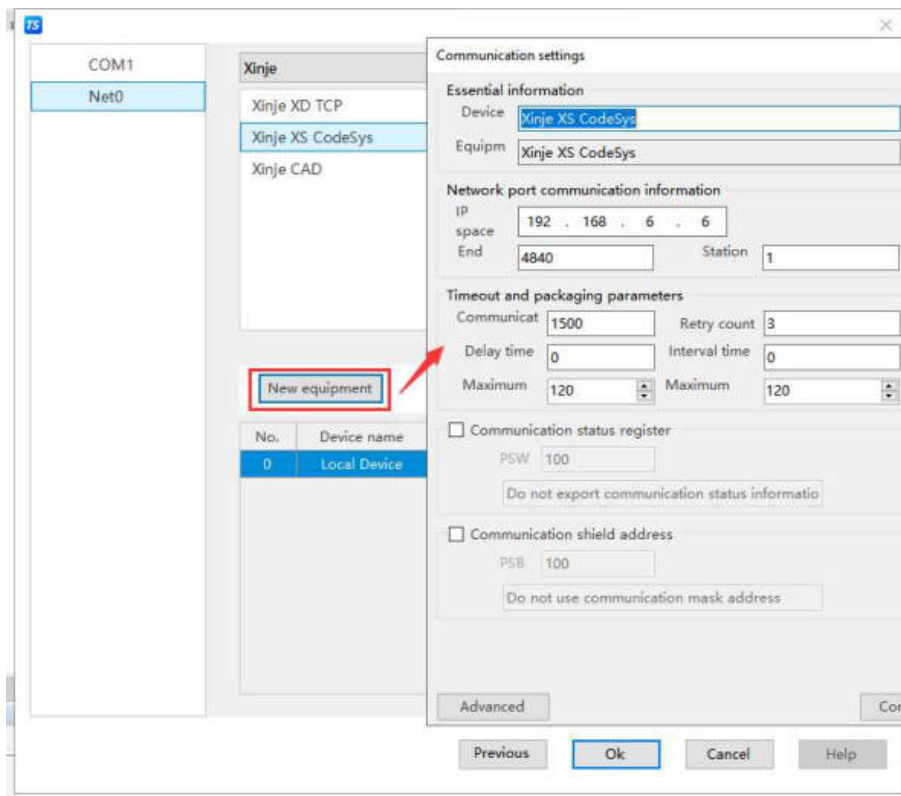

Click “set native IP”, set the IP address parameter in the pop-up window (set to be in the same network segment as the local network card).

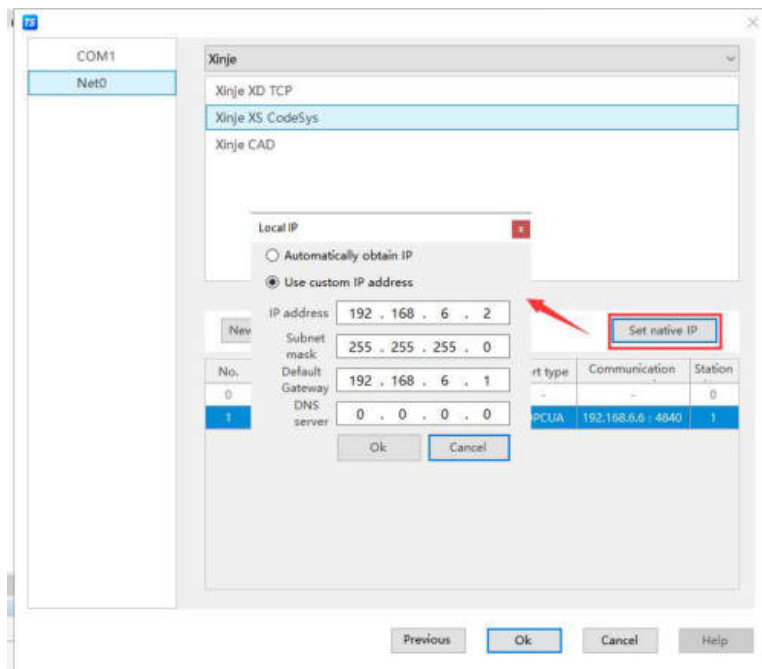

5. Click OK to finish the setting.

6. Generate configuration, click "Generate Configuration" under the "File" menu, and a window will pop up.

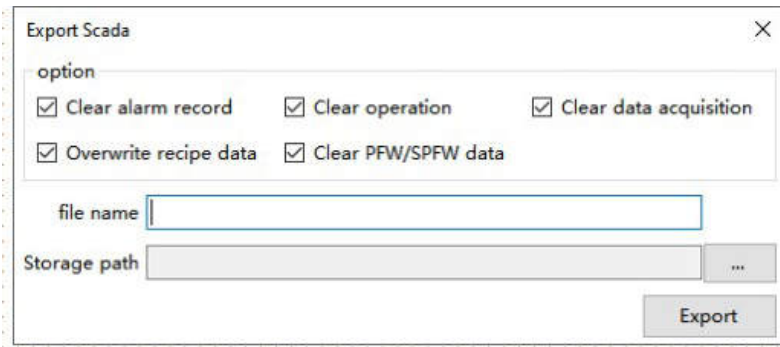

7. Fill in the configuration file name, select the corresponding path, click export, and complete the configuration generation.

8. Open the corresponding folder and run it by double clicking on the corresponding file.

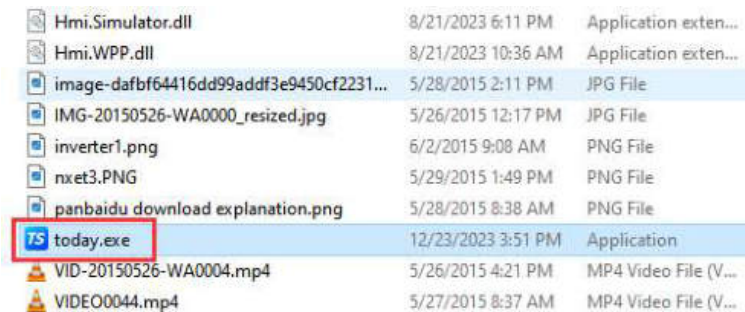

9. Open the corresponding folder, double-click the corresponding file to run it, and a dialog box will pop up as shown in the following figure.



10. At this point, it is necessary to configure the port and connect the device port with the local port. First, click to select the device port number, then click to select the local port number, and then click the middle button. The configuration result will be displayed on the right side.

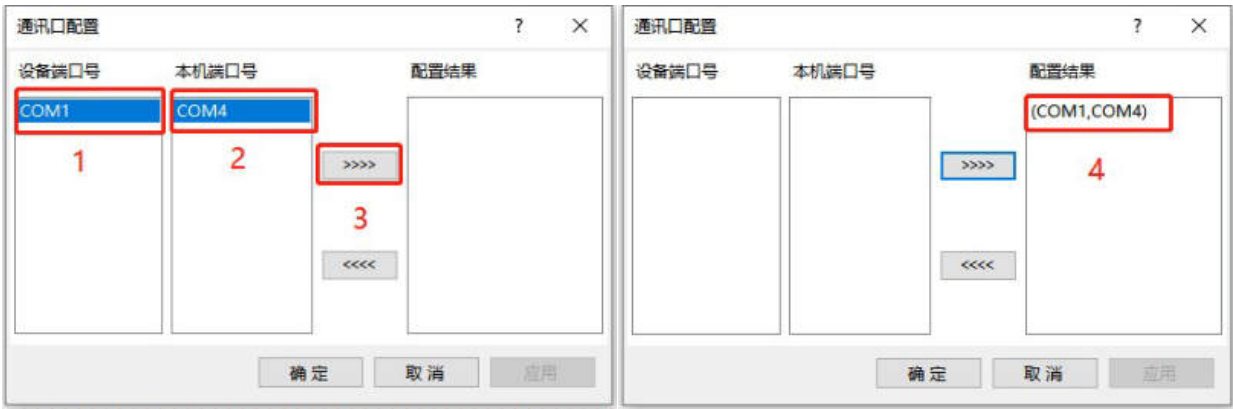

Device port number	Select the HMI port number, which is the COM port selected when creating a new project or adding a device. This can be viewed by clicking on "File/System Settings - Device".
Local port number	Select the port number for connecting the PLC to the computer, which can be viewed through the computer device manager.
Configuration Results	Display port configuration results.

10. After completing the above operations, click "OK" to enter the online simulation screen, which can realize the monitoring function of the computer on the lower computer PLC.



If you need to start up and run automatically, you can add the application to the startup automatic run list.

3. Software screen and window

This chapter gives an overall description of the TouchWin Pro editing tool.



The software part of this manual is based on the status of the primary function software.

3-1. Software structure

Open TouchWin Pro, build a new project.

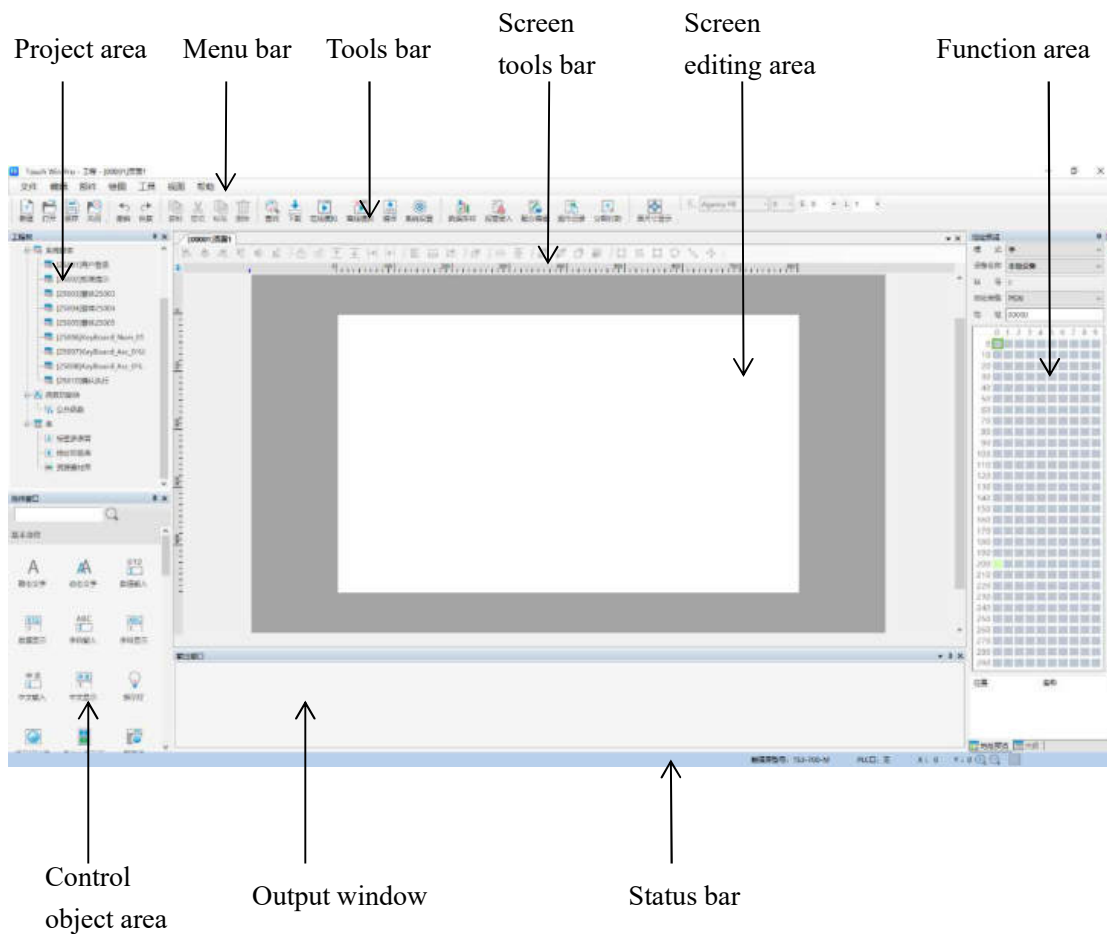

Project area	It involves basic operations such as creating, deleting, copying and cutting pictures and windows, and editing and using function blocks and libraries
Menu bar	There are 7 menus, including File, Edit, Part, Mapping, Tool, View, Help
Tools bar	Some common tools, including creating, saving, copying, cutting, searching, downloading, simulating, etc
Screen tools bar	Some tools for operating the contents of the screen during the screen editing, including alignment, centering, equal width, equal height, combination, etc
Screen editing area	Project screen editing area
Function area	Display and switching of function window can be freely set, including address preview and outline

Control object area	Control list window for screen editing, including basic components, equipment, drawing, data processing and special components
Output window	When the project reports an error, the error message will be displayed here, and the compilation information and results will also be displayed here when the project is simulated or downloaded
Status bar	Display HMI model, PLC port connection device, download port connection device, etc

3-2. Project area

It is mainly used to add, cut, copy, paste and delete images, windows, function blocks and libraries.

3-2-1. Add

1. Add the screen

Select "User Screen" in the project area, right-click and select "Add to", and the following property dialog box will pop up:

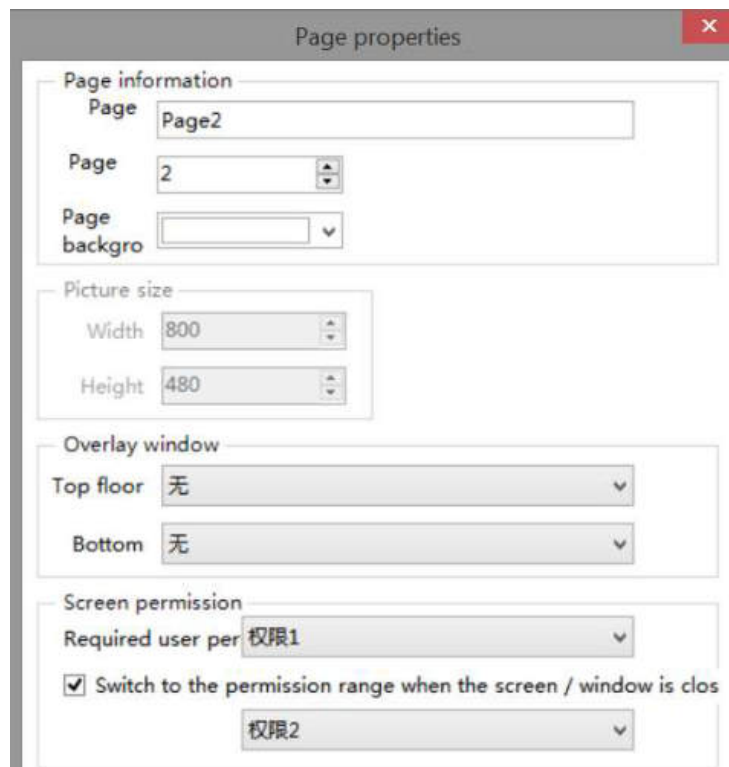
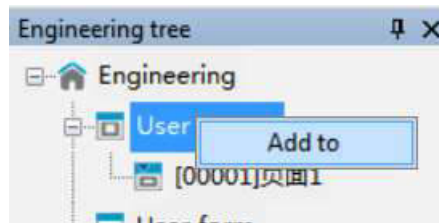

Page name	Customize the name of this screen
Page no.	Set the number of the screen, which is incremented by default. After clicking "OK", the screen number cannot be changed
Page background	Set the background color of the project screen
Picture size	Set the width and height of the screen. If it is a user screen, the picture size is the resolution by

	default and cannot be changed. The user window can freely adjust the width and height
Overlay window	Set the overlapping display window of the picture. Overlapping windows can be set at the top and bottom layers. After setting, the set picture will be displayed on the top or bottom layer of the picture, but the superimposed picture can only be displayed and cannot be operated. For example, if the bottom overlay screen 1 is set in the properties of screen 2, the content of screen 1 will be displayed in screen 2 like the background. The overlay screen will be displayed in gray during project editing to distinguish between the two screens, and will be displayed normally when simulated or downloaded into the HMI. See the following case description for specific use methods
Screen permission	Set operation permission for the current screen
Switch permission range	After checking, when the screen/window is closed, the permission becomes another permission set (As shown in the figure above, when it is closed, the current screen permission is switched from permission 1 to permission 2)

When the screen properties needs to be modified, select "Project Area/Object Screen Number", double-click the mouse left button directly, or click the mouse right button to select "properties".



For the use of overlapping windows, the following is an example.

(1) Add 4 screens

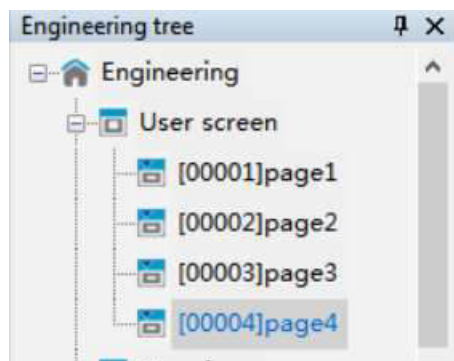

The four pages are shown as below:



- (2) Set Page 2 as the top layer of Page 1. Operating Steps: Right click on Page 1, click Attribute, and select Page 2 at the top level under the overlapping window. At this time, the entire screen tone of Page 1 will darken, making it easy to distinguish between superimposed images. All components of Page 2 will be displayed on Page 1 and the tone will darken, and will be displayed normally when simulated or downloaded into the touch screen.

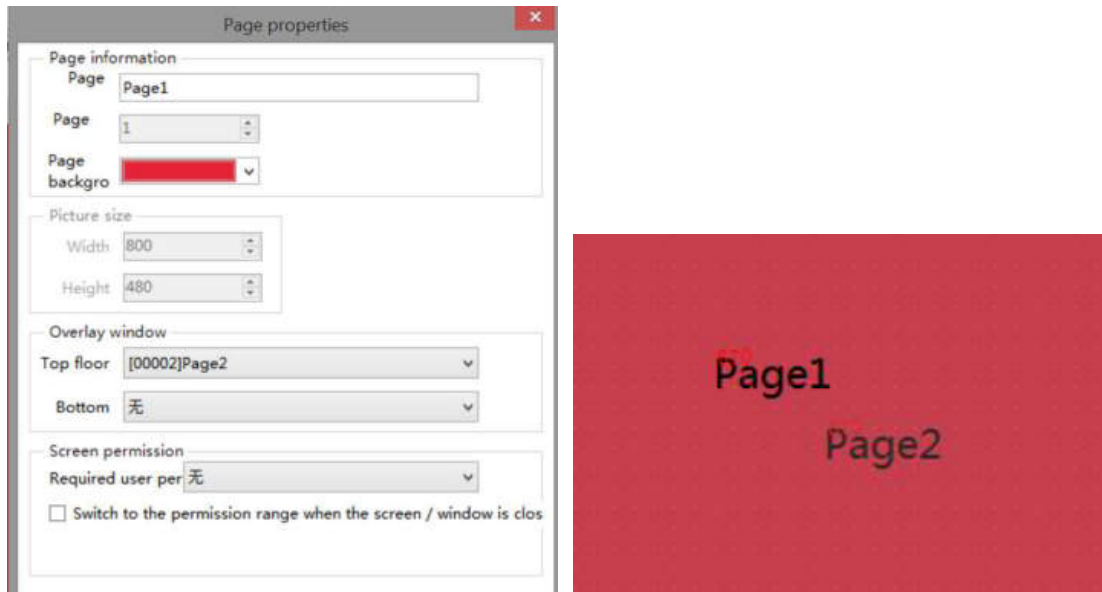

- (3) You cannot open/switch from the current page to a window or page with the current page as the top/bottom layer. Take offline simulation as an example. Set the starting screen as Page 1. Page 1 that jumps from Page 3, 4 will display the superimposed screen, as shown in the figure below.

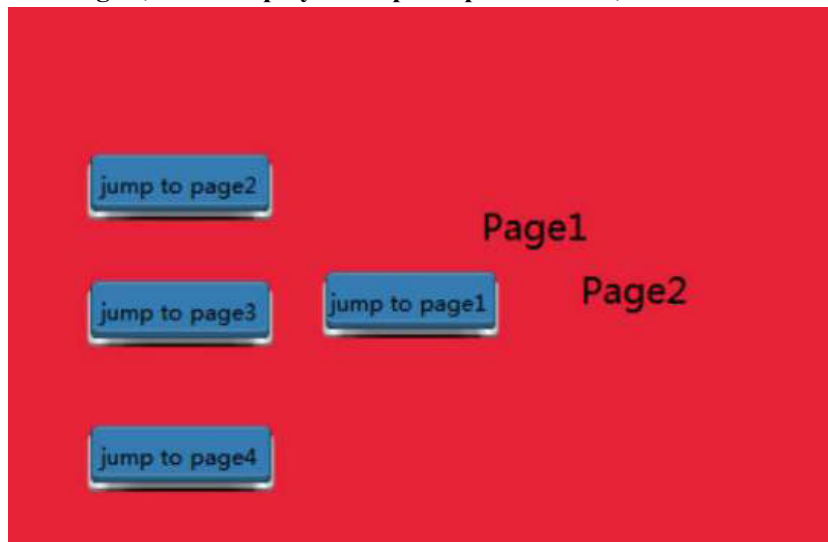

If you click the function key of "Jump to page 2" on page 1, the current screen will still be displayed (that is, the superimposed page 1).

If you click the function key "Jump to page 3/4" on page 1, the screen of page 3/4 will be displayed.

If you click the function key of "Jump to page 1" on page 3/4, the superimposed page 1 will be displayed.

If you click the function key of "Jump to page 1" on page 2, page 1 before superimpose will be displayed.

The same is true for the bottom layer.

If the top layer and bottom layer are set at the same time, the superposition order of screen elements

is current page -> top layer -> bottom layer, and the elements of the current page will be displayed at the top. (As shown in the following figure, the current page is Page 1, Page 2 is the top layer, and Page 4 is the bottom layer)

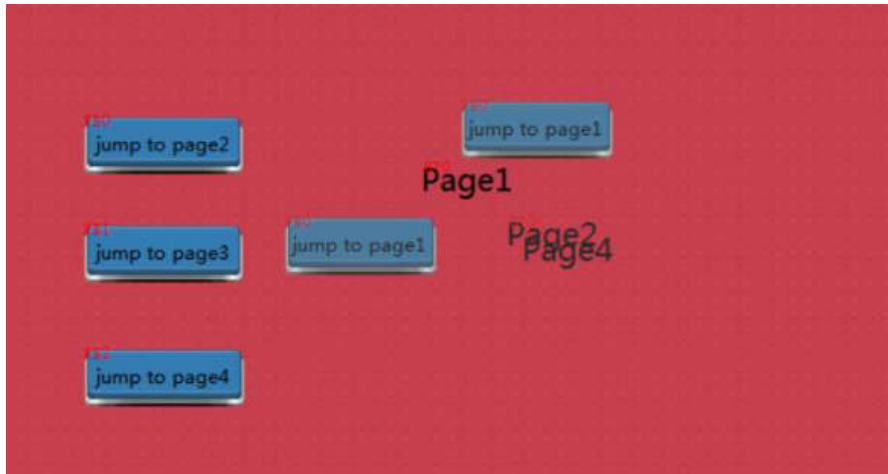

2. Add window

Select "User Form" in the project area, right-click and select "Add to", and the following property dialog box will pop up:

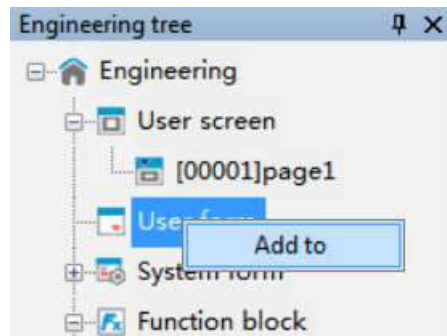

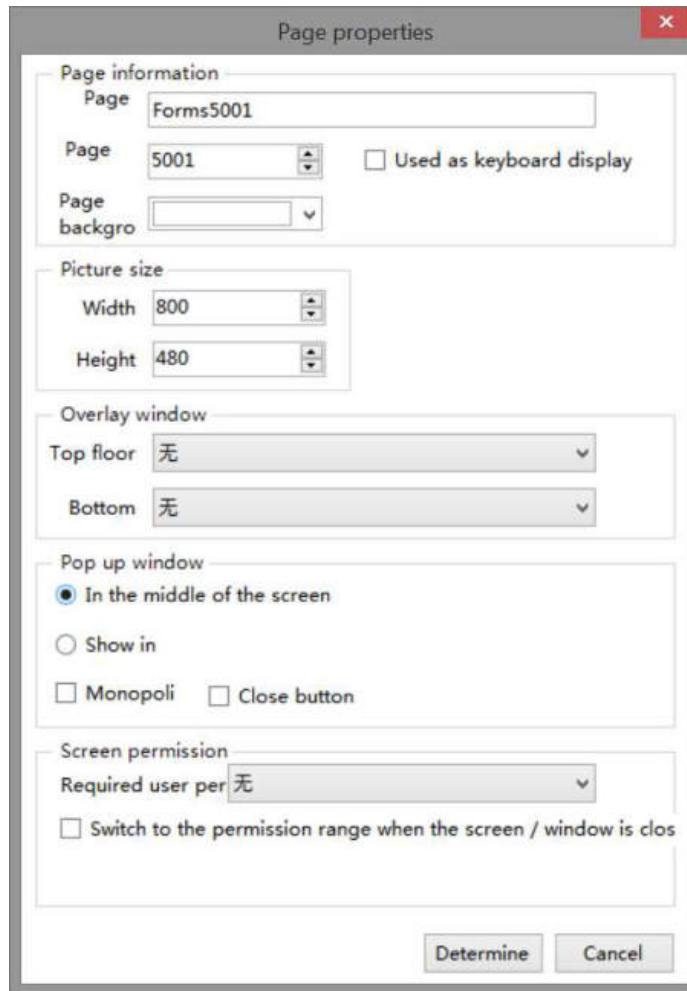

The properties interface of the new form is basically the same as that of the new screen. The following only describes the differences:

Page number	Set the number of the current form, which is incremented by default. After clicking OK, the form number cannot be changed. Different from the screen, the number of the form starts from 5001
Picture size	Set the width and height of the form. The width and height can be adjusted freely
In the middle of the screen	Place the form in the center of the entire screen
Show in	The customizable form is located in the whole screen
Monopoly	When monopoly is checked, as long as this window is called, no other components in the screen can be clicked except the components in this window. When this window is closed, other components can be clicked normally, which is usually used in conjunction with the "close button"
Close button	After checking, the user does not need to do the close button alone, and there will be "×" close button

3-2-2. Copy paste

1. Select the screen to be operated, right-click and select copy.
2. Select the user screen in the project area, right-click and select "Paste" to complete the operation.

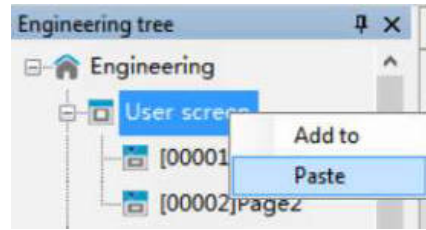
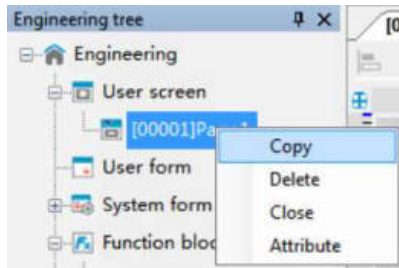

3-2-3. Delete

Select the screen to delete, right-click and select Delete to delete the screen.

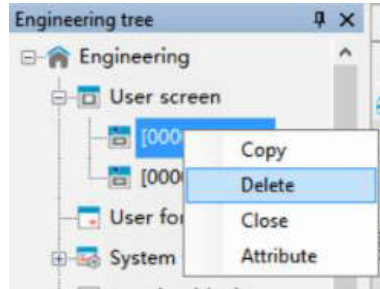

The operations of adding, copying, pasting and deleting "user window and function block" are the same as above.

3-3. Menu

The menu bar includes 7 groups of menus: File, Edit, Parts, Drawing, Tool, View and Help.

3-3-1. File

The file includes various operations on the project, such as new, open, close, save as, download, simulation, encryption save project.

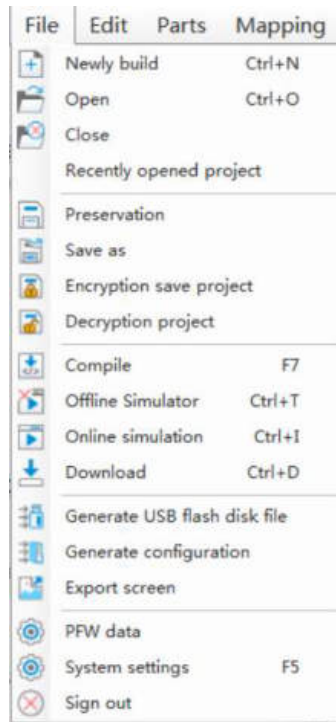

1. New



Create a new program, set the display and communication equipment, press Ctrl+N, and refer to section 2-1 for details.

2. Open



Click File/open or open icon in the tool bar, or press Ctrl+O, it will show below dialog box, select a project and click Open or double-click the project directly.

3. Close



Click File/close or close icon in the tool bar to close the project. But it will not exit the software. If the project is not saved, the following prompt window will pop up.

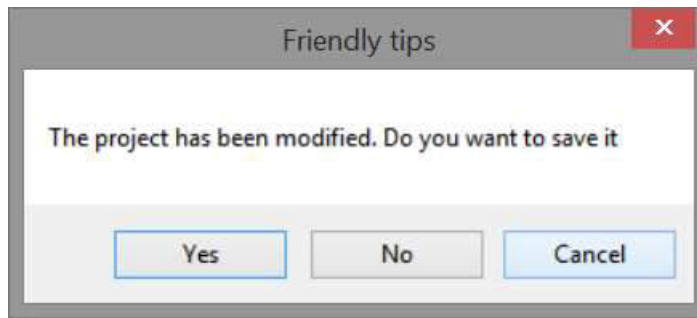

Yes	Save the project. Then exit project editing
No	Do not save. Then exit project editing
Cancel	Return to screen editing status

4. Recently opened project

If the user has opened or edited some projects recently, the software will automatically remember the path and name of these projects, so that the user can find these projects more quickly without having to re-find the project path. Move the mouse to File/Recently Opened Project, and the recently opened project will be displayed on the left. Click to open the corresponding project.

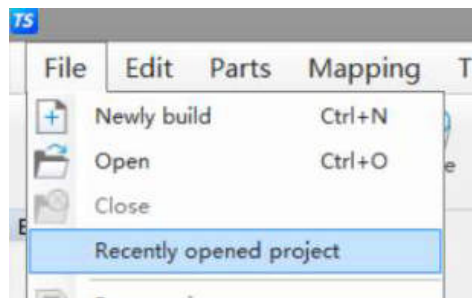

5. Save

Click File/save or save icon . Open the save dialog box, select the save path, enter the project name, and click Save.



In the process of editing the project screen, the user should save at any time to avoid data loss.

6. Save as

This operation is different from Save. Save uses a new file to replace the old one based on the original project. Save As saves the current project as a new project. After the Save dialog box pops up, select the storage path, enter the file name, and click Save.

7. Encryption save project

When the programmer needs to protect his own program and must give the program to the customer to download, the programmer can choose to encrypt and save it. After the file saved in this way is opened with editing software, the content of the screen cannot be seen, and no parameters can be modified. Only downloading and simulation can be done.

Operation steps:

- ① Open the project to be encrypted and click File - Encryption Save Project.

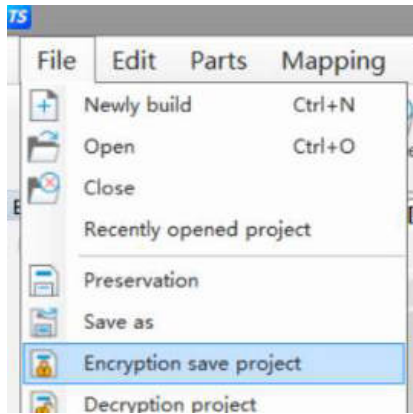

② After clicking, the pop-up window for entering password will appear, please set the encryption password (the password cannot be less than 6 digits)



③ After entering the password, set the save path of the encryption project. The file default is the xep format, which cannot be changed

④ Open the path where the encryption project is located, and you can see an encrypted file ending in xep



⑤ The encrypted file can only be opened for decryption, download, online simulation, offline simulation, compilation and other operations, and the project content cannot be modified in any way.

8. Decryption project

It is used to decrypt the encrypted project. The decrypted project can be edited and downloaded normally.

Operation steps:

① Open the encrypted project. Refer to "7. Encryption save the project" above for the operation steps. Click File - Decryption Project.

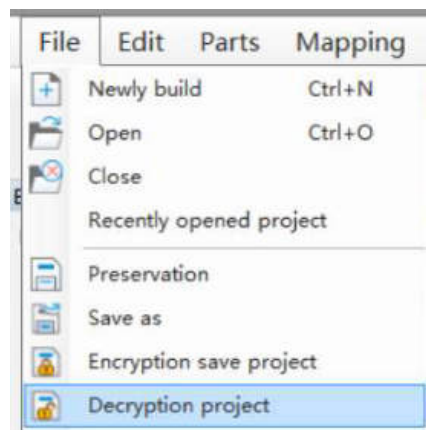

② Enter the password set during encryption and click OK.



- ③ Select the save path of the decryption project and click Save to generate a project that can be edited and downloaded normally.
- ④ There will be a pop-up prompt after saving successfully.

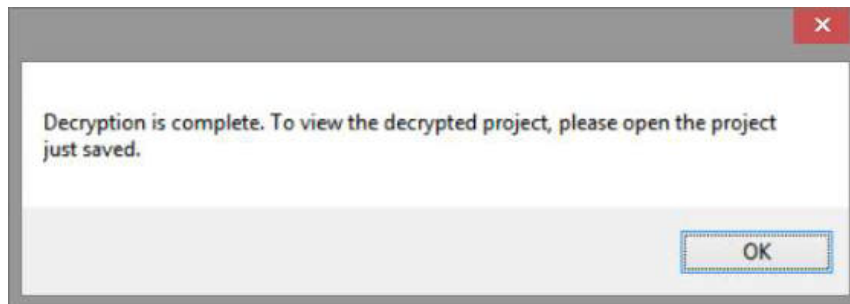

- ⑤ Open the save path of the decryption project. After the project is opened, it can be edited or downloaded normally.

9. Compile



Click File/compile or . The system will check whether all control properties in each screen and window have errors. Compilation is a prerequisite operation for simulation and download. When you click Online Simulation, Offline Simulation or Download, the system will automatically execute the compilation operation. When compiling, a pop-up window as shown in the left figure will pop up in the center of the software, and the compilation information and results will be displayed in the output window

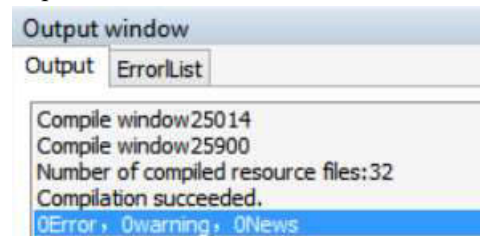
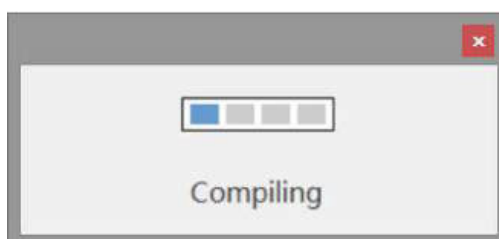

10. Offline simulation

In order to facilitate the user to debug and edit the screen, simulate the actual operation of HMI and PLC on the computer (no need to connect PLC). Click File/offline simulation or  to perform offline simulation.

11. Online simulation

Simulate the actual operation of HMI and PLC on the computer to realize the monitoring function of the lower computer equipment (PLC must be connected to the computer). Click File/online simulation or  to perform online simulation.

12. Download

Realize downloading the editing screen data to the HMI, click File/download or  or press Ctrl+D to perform downloading function.



For detailed operations of offline simulation, online simulation and download, please refer to chapter 2-3, 2-4 and 2-5.

13. Generate USB flash disk file

Export and store the project as dat file. The file name can be customized, but the suffix must be Dat, copy the generated file to the root directory of the USB flash disk, connect the HMI with the USB flash disk, and download the file directly to the TS series HMI.

Operation steps:

- Click File/Generate USB flash disk file, it will show path selection dialog box. Click , select the path to be saved in the pop-up window, and enter the name of the USB flash drive project file to be saved. Please note that the file must be saved as .dat.

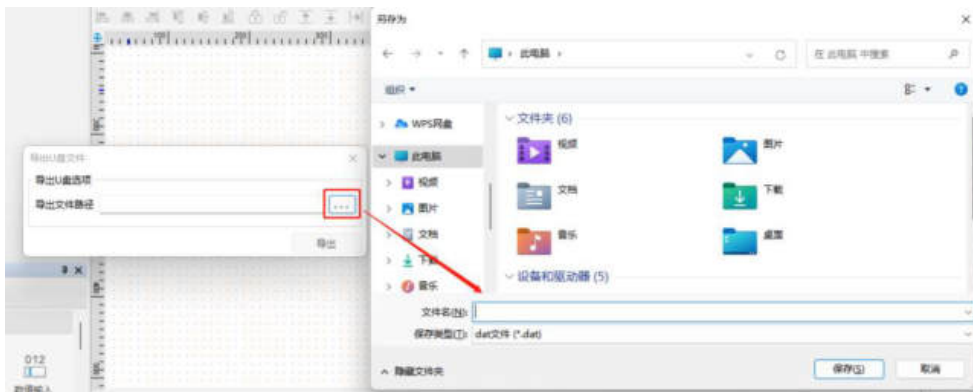

- After selecting the path, click the "Export" button.



Note: HV1 is an old version and HV2 is a new version. Only HV1 can be selected for the old version of the touch screen, and only HV2 can be selected for the new version of the touch screen. Otherwise, the firmware will be prompted as incorrect. Please refer to 7-3 for the hardware version of the touch screen currently used Device information.

- If the export is successful, you will be prompted as shown in the following figure, and a file will be generated in the saved path. The file type must be .dat (do not modify the file suffix). Copy the file to the root directory of USB flash drive for later use.

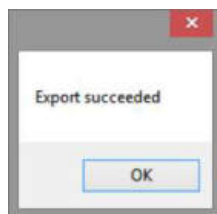

- Insert the U disk into the U disk port of the HMI, and the "U disk update" pop-up window will pop up in the upper left corner of the HMI. Click "Update HMI Project", and the file selection window will pop up, as shown in the following figure on the right. Select the project to be imported in the list, and click "OK" button at the lower right corner. The system will automatically import the project file, and the progress bar of the import project will be displayed on the screen. After the import is completed, remove the U disk.

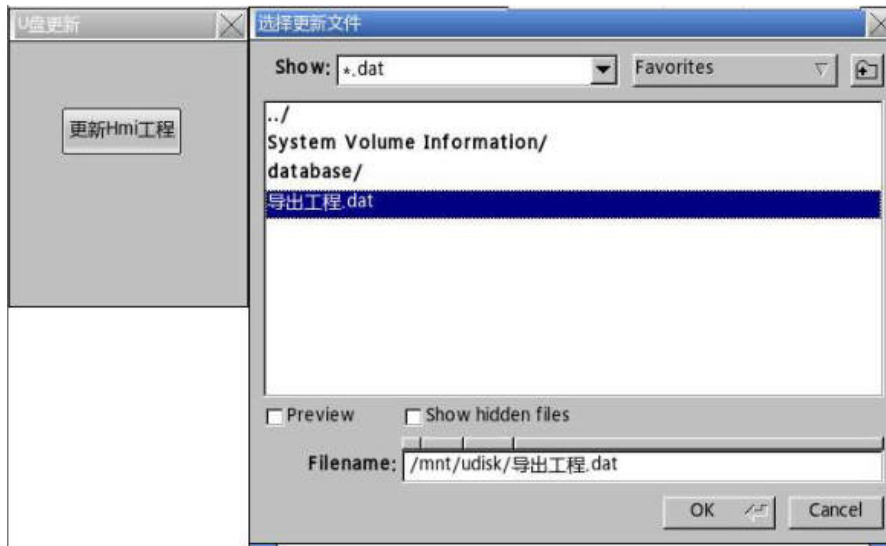

⑤ Import is successful.

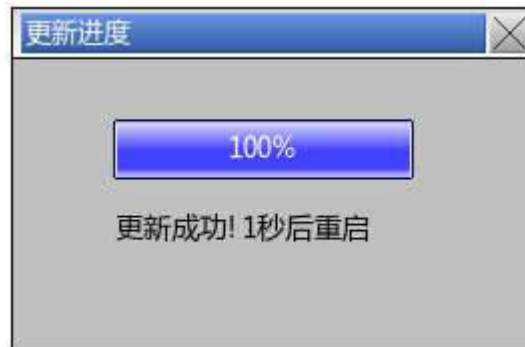

The "Allow project upload" set in the software download interface does not take effect after the project is updated with a USB flash drive, that is, the project updated with a USB flash drive is not allowed to upload.

14. Generate SCADA

The SCADA generation let the computer replaces the HMI and communicates directly with PLC and other external communication devices. The difference between its function and the online simulation function is: when the online simulation function is implemented, the user needs to install TouchWin Pro editing software. The user does not need to install TouchWin Pro editing software when the SCADA is running.

Operation steps:

- ① Click File/generate SCADA
- ② Set the saving path and file name

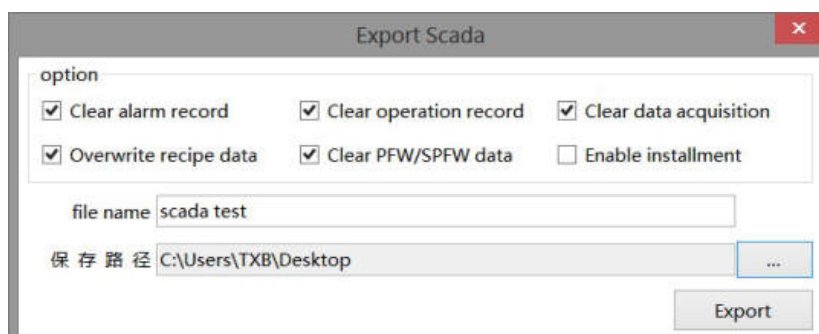

③ Generate SCADA is successful.

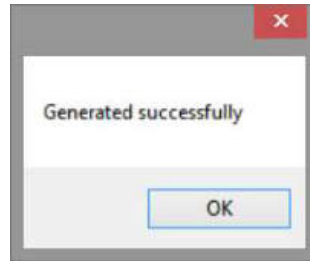

④ Generate four files in the saved path, click the SCADA name .exe file, and configure the communication port to run normally.

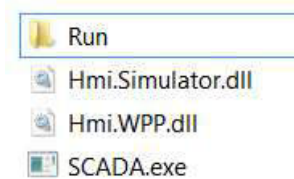

Refer to chapter 2-4 for the configuration interface of communication port.

15. Export screen

The function of screen export is to save screens in the form of pictures or PDFs for document writing or picture preview. The name is picture name+ID. Click the "File" menu and select "Export Screen", and the following window will pop up:

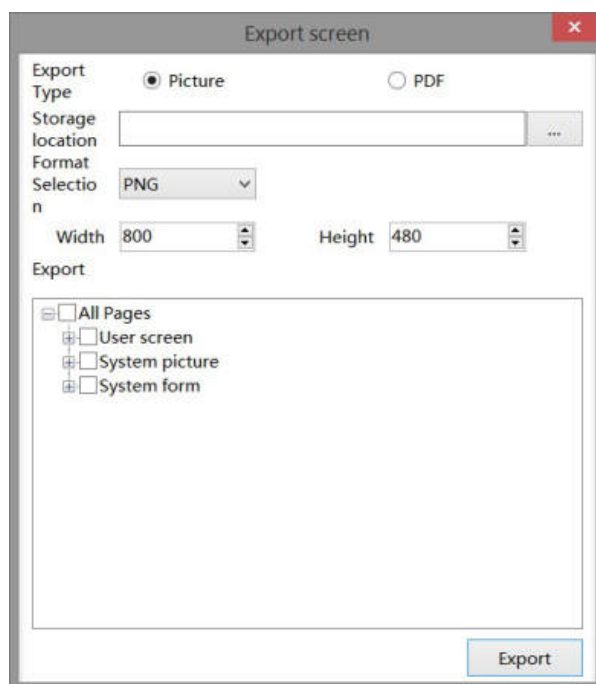

Export type	Select the format of screen export. The default export is picture format, or PDF format can be selected as required. After selection, the screens in the project will be exported in the form of pictures or PDF
Screen selection	Select the screen to be exported. You can select a screen or window to export, or select all to export
Format	Select the export format. If the export type is a picture, the optional formats here are png, jpg and bmp. If the export type is PDF, there is no optional format here
Storage	Set the export path, click "Select Folder", and set the target path in the pop-up window. The selected image or PDF will be saved in the path set by the user
Size	When selecting an image for export type, you need to set the width and length of the generated image. The default is the display size of the selected HMI model for the current project. You can customize the width and length of the exported image according to your needs

After setting the parameters, click Export. The system will automatically perform the export task. If the export is successful, the export successfully window will pop up.

16. PFW data

This operation is to modify the system parameters of the project. After the program is downloaded again, the PFW data is initialized. Generally, when the recipe function needs to set the initial value, it can be modified after being downloaded to the HMI.

- Set PFW address range

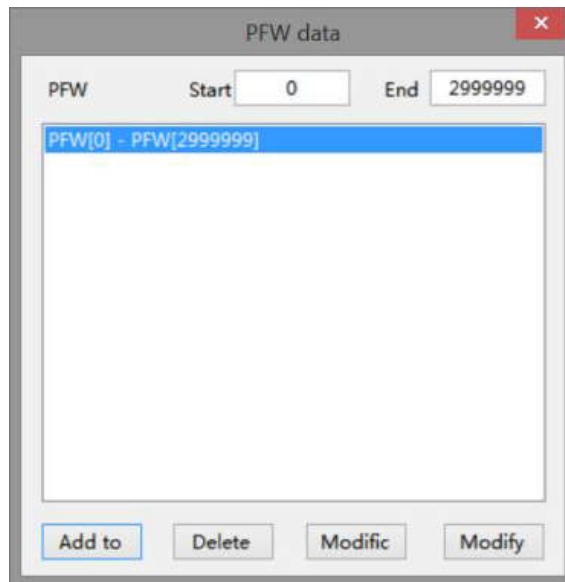

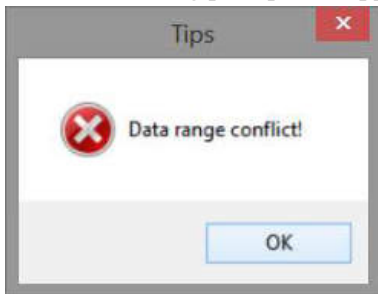
Start PFW	Set PFW register data starting address
End PFW	Set PFW register data end address  The terminal PFW address is not greater than the number of system settings - monitor - parameter – number of PFW
Add to	After setting the start and end addresses, click Add to list the data segments in the data setting list
Delete	Delete the added data segment. After selecting it, the row becomes blue. Click Delete to delete it
Modific	When the start/end address needs to be modified, select the data segment, modify the address range, and click Modific. When the set data segments conflict, the following prompt will appear. 
Modify	Modify the register value within the set address range
Set PFW value	Select the PFW data segment, click Modify, or double-click the PFW data segment to open the data setting window as shown in the following figure

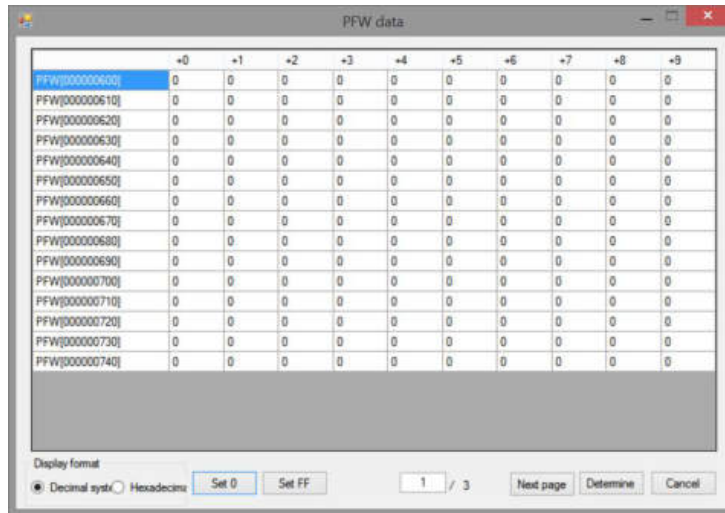

- Decimal: data display in decimal format
- Hex: data display in hex format
- Set 0: set all data in the setting segment to 0
- Set FF: Set all data in the setting segment to FFFF
- OK: make the settings effective
- Cancel: not effective

17. System settings

This operation is to modify the system parameters of the project.

■ Parameter

Click "Parameters" to directly set the startup screen, screen saver, mouse cursor and sound parameters.

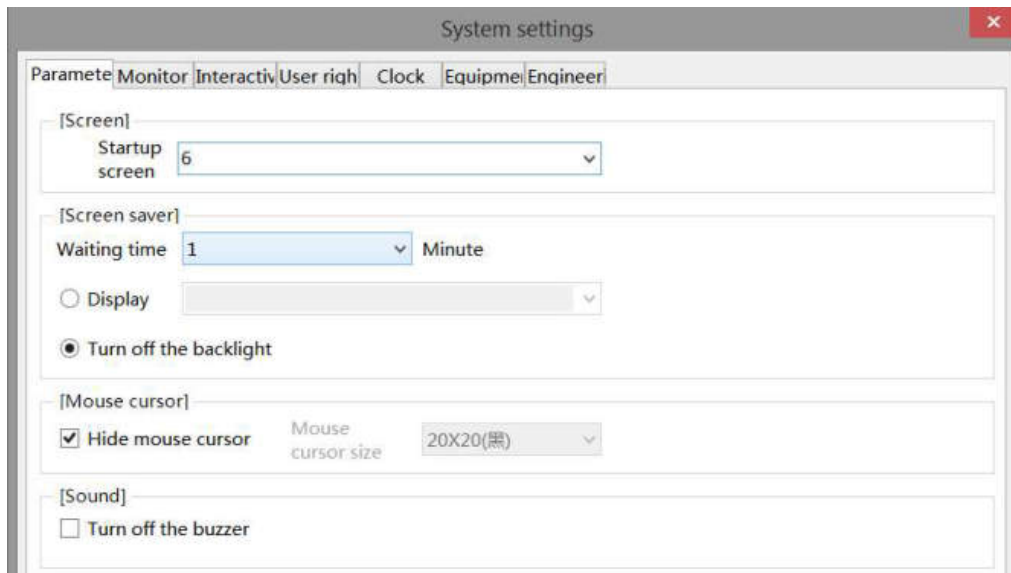

Screen	Input the startup screen number, that is, when the HMI is powered on after downloading the program, the screen that runs first is usually the main screen of the program or the screen with the highest frequency of use
Screen saver	This function is an automatic measure when the HMI is not triggered for a long time. After a period of no trigger operation, the touch screen can turn off the backlight or jump to the specified screen according to the settings
Waiting time	Select time or no screen saver according to user requirements

Display	When the time conditions are met, jump to the target screen
Turn off the backlight	Turn off the backlight when the time conditions are met Note: Only one operation can be selected between turning off the backlight and display screen
Hide mouse cursor	When checked, the mouse cursor will not be displayed when the touch area is clicked
Mouse cursor size	Set the size and color when the mouse cursor is displayed. The color can only be black or white
Sound	It is used to set whether the screen will emit sound when the HMI is working normally. The default is that there is sound output. If "Close buzzer" is checked here, no sound will be emitted when the HMI is working, whether the screen is clicked or the alarm is triggered

■ Monitor

Modify the HMI model and display direction.

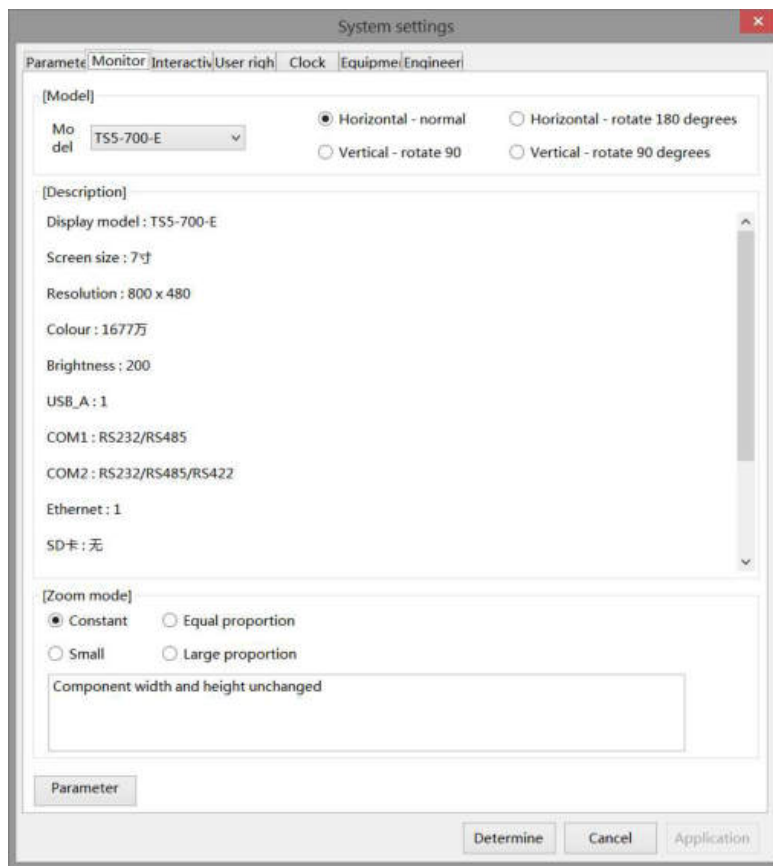

Model	Display the current HMI model and display direction. If you want to modify the display model, you can click OK to take effect after selecting a new display model and setting the display direction correctly. The display direction defaults to normal horizontal display. In order to adapt to various occasions, we provide the options of 180° rotation, 90° clockwise rotation and 90° counterclockwise rotation. The rotation options are appropriate according to the actual use situation. (The default is horizontal display. If it is switched to other display directions, it will automatically jump to the calibration screen after downloading, requiring the user to calibrate again)
Description	Display the current screen size, resolution, color, brightness, USB port, COM port and other information
Zoom mode	When changing the display model, the proportional relationship between the width and height of components in the screen and the display size

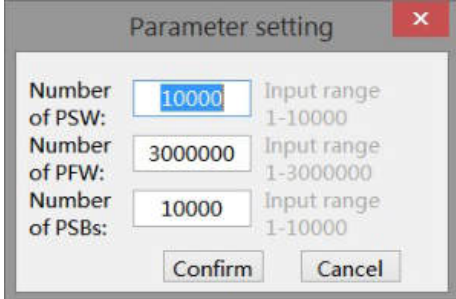
Constant	Component width and height remain the same
Equal proportion	The width and height of components are scaled according to the width and height of the display
Small	The component width and height values are scaled according to the small value of the display width and height ratio
Large proportion	The width and height of components are scaled according to the large value of the width and height ratio of the display
Parameter	Set the number of system registers 

■ Interactive

It mainly realizes the attribute relation between the screen and the register. Click Interact, and the settings shown in the following figure appear:

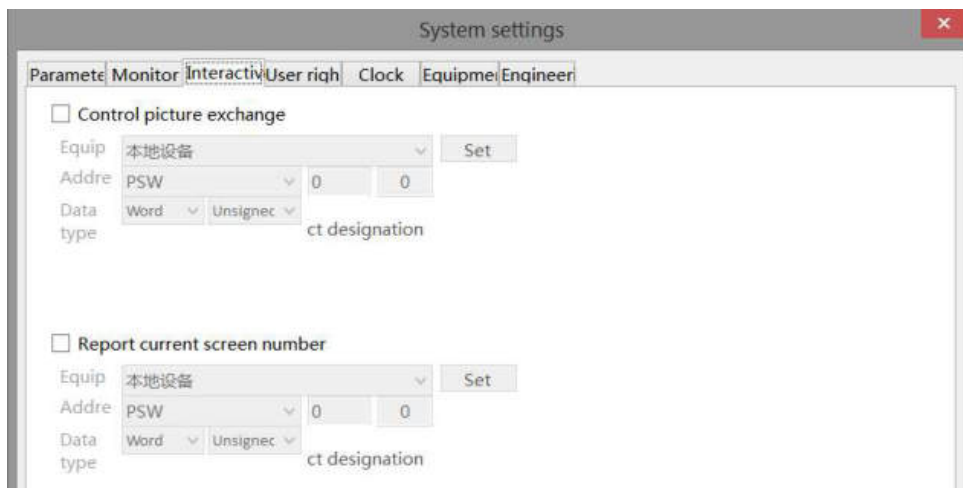

Control picture exchange	Jump to the screen according to the value of the current register. If the register value is 10, it means jump to the screen No. 10. Use the PLC register to control the screen switching. It is recommended to use the rising edge or falling edge signal for the triggering conditions.
Report current screen number	The screen number of the current operation screen is displayed. If the current operation interface is screen 7, the register will display 7
Equipment	Current equipment port for communication
Set	Click to enter address setting, and select to use system register or user-defined label in the pop-up window
Address	Set the object type and address of the current register
Data type	Set the data type of the register selected in the previous item. Byte represents 8 bits, Word represents 16 bits, DWord represents 32 bits, and DDWord represents 64 bits. In the second box, you can select decimal, hexadecimal, unsigned number, floating point number, etc
Indirect designation	The current register address changes with the indirectly specified register value, that is, $Dx[Dy]=D[x+Dy \text{ value}]$ (x, y=0, 1, 2, 3...)

■ User rights

The user authority function plays the role of engineering and data protection to improve program security. Authority settings are usually used for hiding and encrypting parts or pictures. Relevant operations can only be performed when the password is correctly entered.

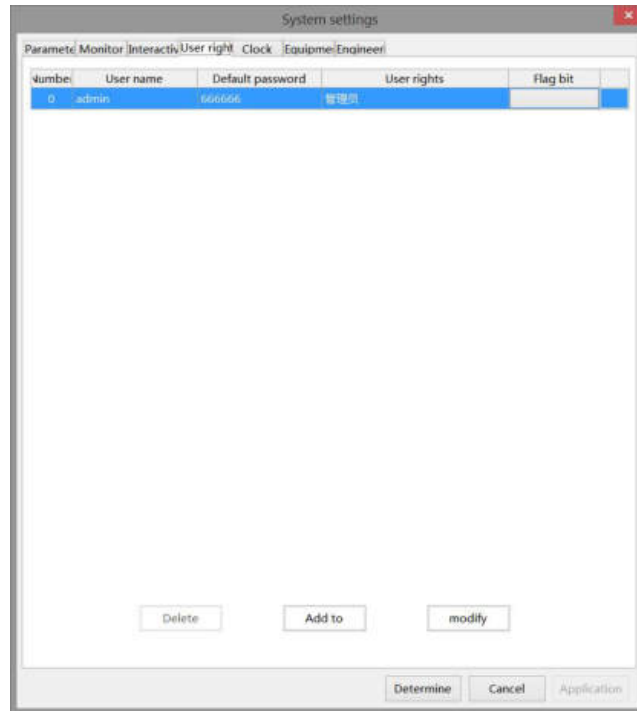

There are 30 permissions from "Permission 1 to Permission 30" set here, each of which is an equal level. Click the "Add to" button to add a user when using it. When adding a user, check the range of permissions that the user can operate, as shown in the following figure. After entering the password of the user "User1", you can operate the password protection functions of Permission 1, Permission 2 and Permission 3. At the same time, the corresponding flag is ON.



Password input range: 1-8 digits and characters.

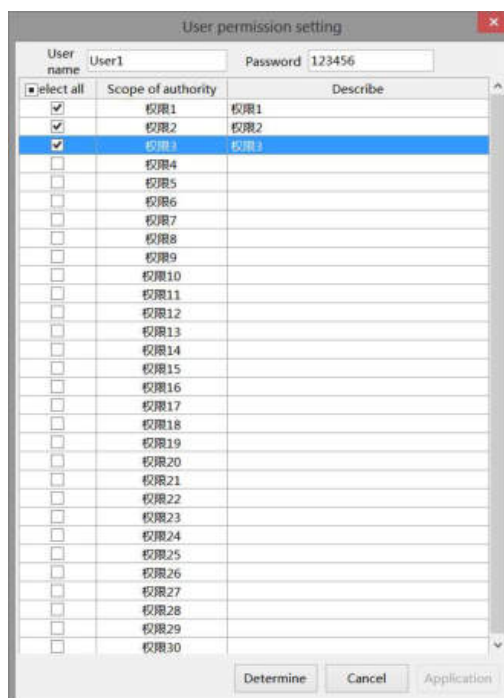

If multiple users need different permissions, you can add users according to the above operations and select corresponding permissions. By default, the project has an administrator permission of Admin. The administrator permission level is the highest, and all permission protection functions can be operated.

Here are two ways to log in:

- (1) Call the user login interface through the function key

See the following figure for operation steps:

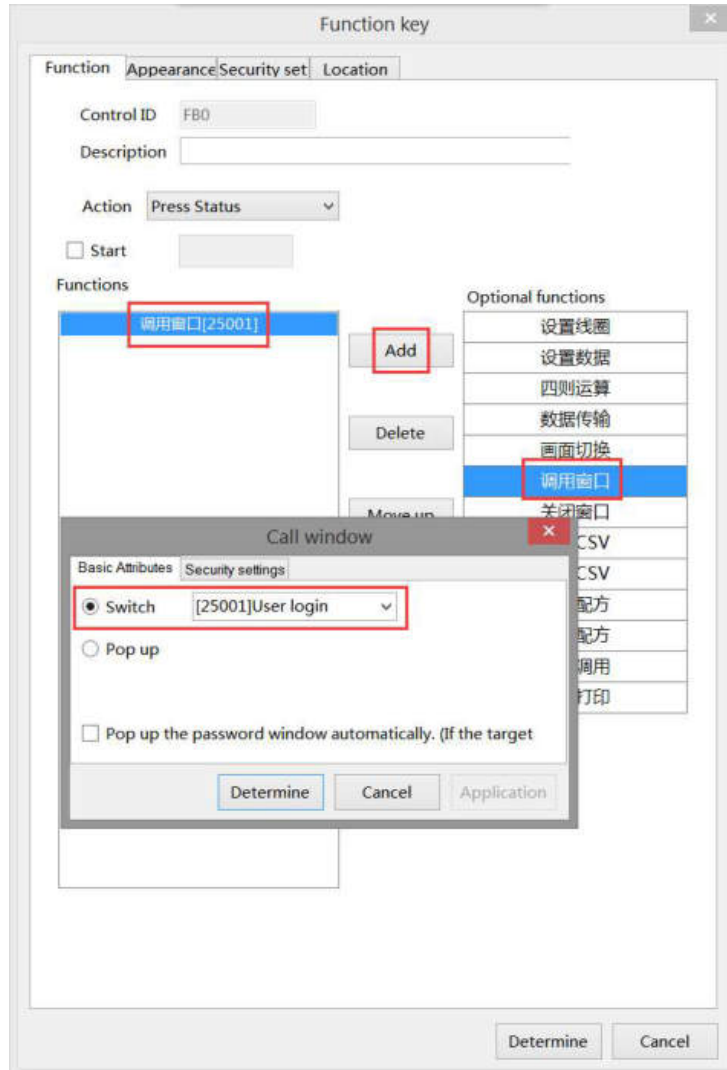

Click the function key to call up the user login window (see the figure below), select the user name to log in, enter the password correctly, and the lower left corner will display the login successfully, if the password is entered incorrectly, the login failure will be displayed.

Take user1 as an example.

Select the user name of User1 from the drop-down list, enter the correct login password 123456, and click the "Login" button to display that the login is successful (see the left figure). At the same time, the password will be cleared. After the login is successful, you will have permissions 1, 2, and 3 at the same time. To log out, also select User1's user name in the drop-down list, enter the correct login password 123456, and click the "logout" button to display that the logout was successful (see the right figure). At the same time, the password will be cleared, or you can quickly log out by turning the flag position OFF. After the logout is successful, the user will have no rights (1, 2, 3).



(2) Select "When the user has no permission, a prompt window will pop up"

Taking the indicator button as an example, the settings are shown in the figure below

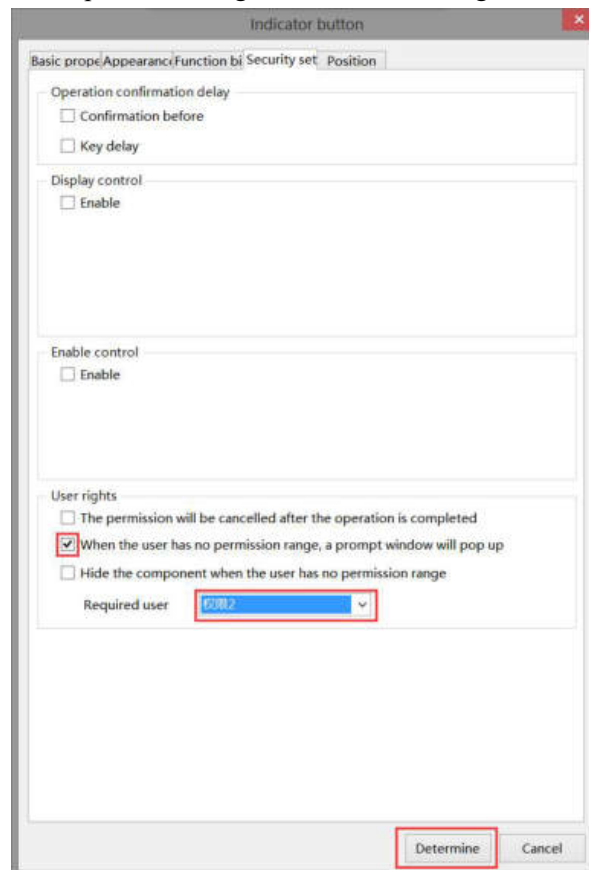

Download to the screen, click the indicator button, and the following window will pop up



Click "User Login" to enter the user login interface. Refer to User1 login introduction above for the operation steps. Click "OK" to close this pop-up window

■ Clock

The HMI is equipped with the clock function as standard, which is mainly used to set the clock source and transmit the touch screen clock to externally connected PLC and other devices.

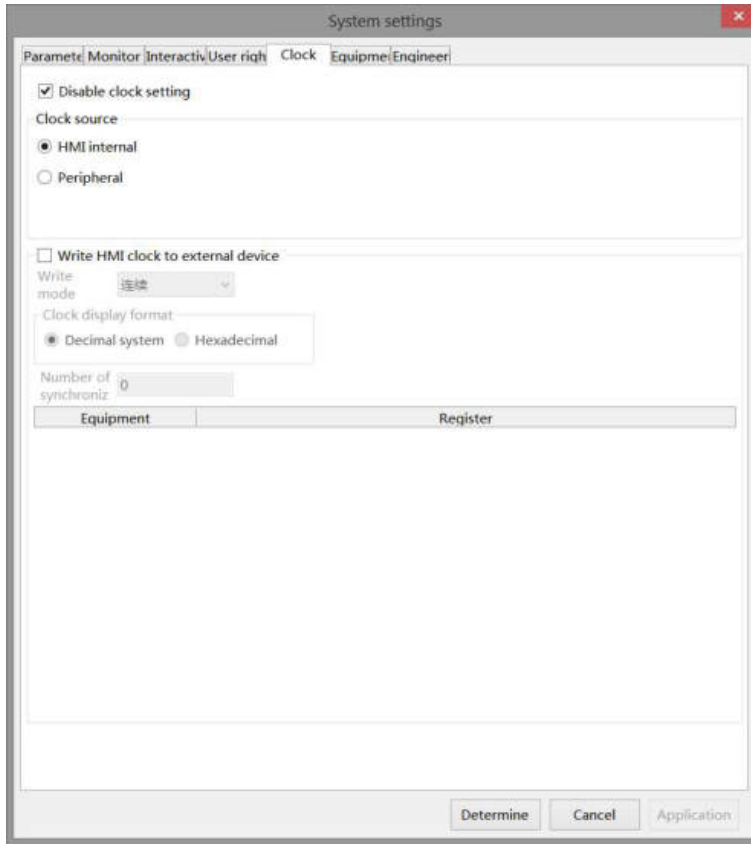

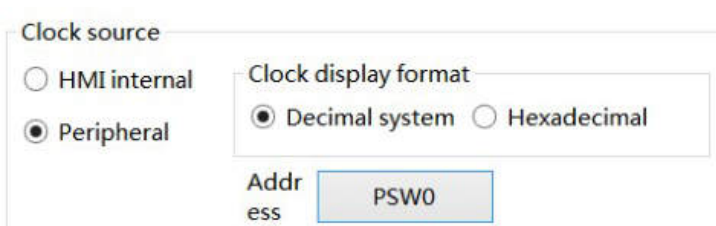
Disable clock setting	If selected, the HMI internal clock cannot be modified, which is used for installment payment and other time encryption projects to prevent the clock modification from affecting the function
Clock source	<p>To set the clock source of the HMI, you can choose to use the HMI internal clock or import from an external device. The default is the HMI internal clock. When you select an external device, the following settings will appear</p> 
Clock display format	<p>When setting to read from an external device. You can select decimal or hexadecimal format.</p> <p>For example: when HMI communicates with Xinje PLC, if you choose to read the clock from the external device, and Xinje PLC clock format is hexadecimal, so the clock display format here should also be hexadecimal.</p>
Address	<p>Set the first address of clock reading, that is, read the time from the set address, and set it as the time of HMI. The address requires that year, month, day, hour, minute and second each occupy a single word (16 bit) register, excluding week. For example, if the address is set to D0, the values of 6 registers D0~D6 will be read from D0, which will be used as year, month, day, hour, minute and second in turn</p>
Write mode	<p>After checking "Write HMI clock to external register", you can set the HMI clock export mode. You can select continuous, trigger or cycle. The default is continuous, that is, every second change can be written to the external address in real time. When you select trigger or cycle, you need to set the transmission conditions, as shown in the following figure. Note that when the writing mode is cycle, the minimum cycle cannot be less than 100 milliseconds.</p>

Write clock to peripheral
Write mode: Trigger
Read: PSB0 Mode: Rising edge

Write clock to peripheral
Write mode: Cycle
Cycle: 1 0.1 secor Register PSW0

Number of synchronization

Customize the number of HMI clocks written to external devices. If the touch screen is connected to multiple devices at the same time, the number of multiple devices can also be set here. The number of rows corresponding to the number set here will appear in the table below, and the first address corresponding to each device needs to be set in the table below. The same as the external reading above, when writing to the external device, there are 6 registers, including year, month, day, hour, minute and second, excluding week. Example: If the address is set as D0, D0~D5 will display year, month, day, hour, minute and second in turn, occupying 6 register addresses.

Number of synchroniz: 2

Equipment	Register
设备0	设置
设备1	设置

■ Equipment

It mainly sets the communication parameters between HMI and PLC and other external equipment

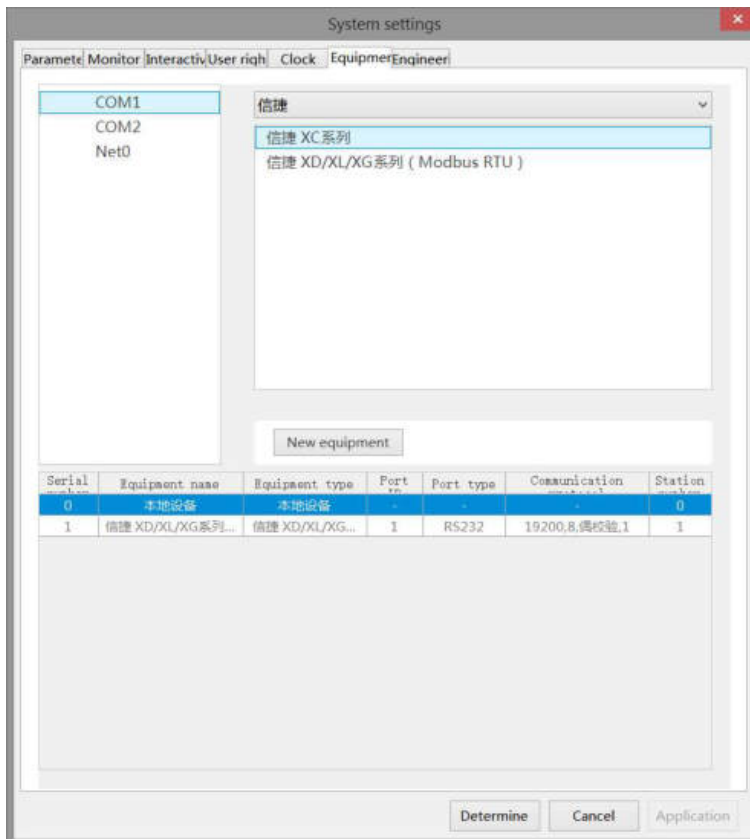

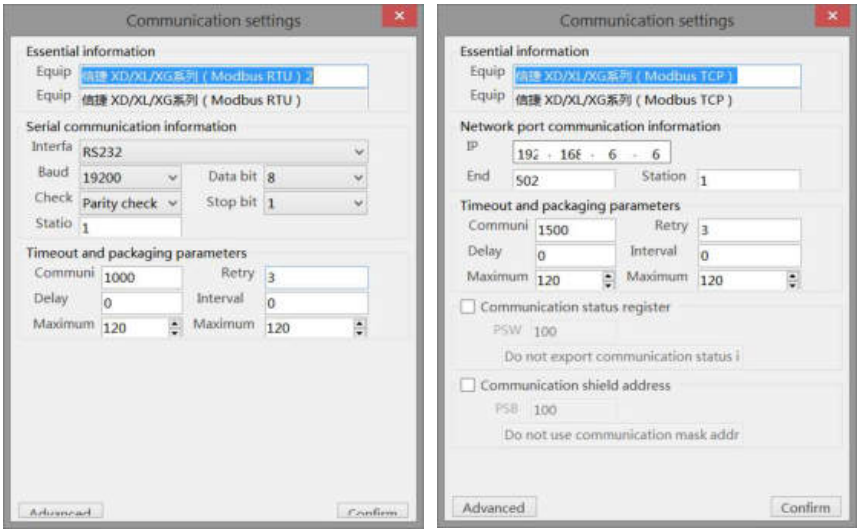
New equipment	Add different device types. Select COM1/COM2/Net0 on the left and click "New equipment" to add a new device
Equipment name	The name of a user-defined device. When multiple devices are added to the same serial port, the name cannot be duplicate
Equipment type	The protocol name
Port ID	The COM port where the device is located is automatically generated by the system, no need to set
Port type	The interface type selected when creating a new device is generally RS232, RS485, RS422 or Net
Communication protocol	<p>When it is on the serial port, the baud rate, data bit, parity mode, stop bit and other parameters are displayed here.</p> <p>When it is on the Ethernet port, the IP address and port number of the device are displayed here. Double click to modify the parameters.</p>
	
Station no.	Device station number. When multiple devices are added to the same serial port, the station number cannot be duplicate

■ Project

This item is used to set the name, author and comments of the current project. If the current project has been saved, the name item displays the name of the project and cannot be modified.

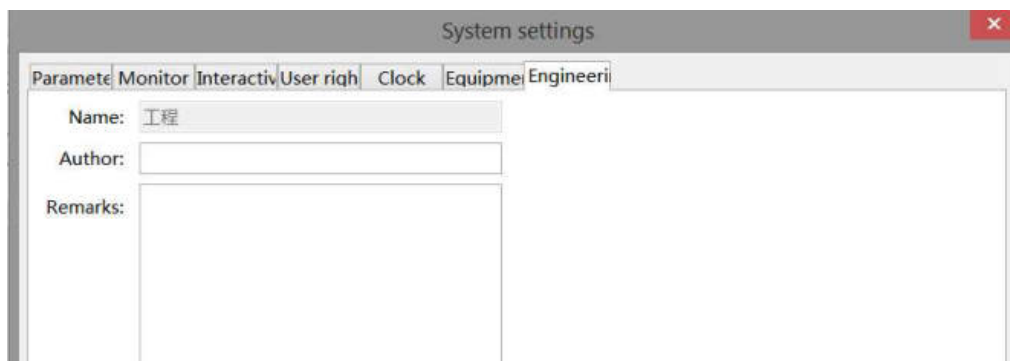

16. Sign out

This function is used to exit the TouchWin Pro editing software, which is different from the "Close" operation. If the user does not save the project, a save window will pop up to avoid losing the operation

3-3-2. Edit

The Edit menu is mainly used to edit components. The corresponding shortcut keys can be found in the toolbar for the functions in editing, as shown below:

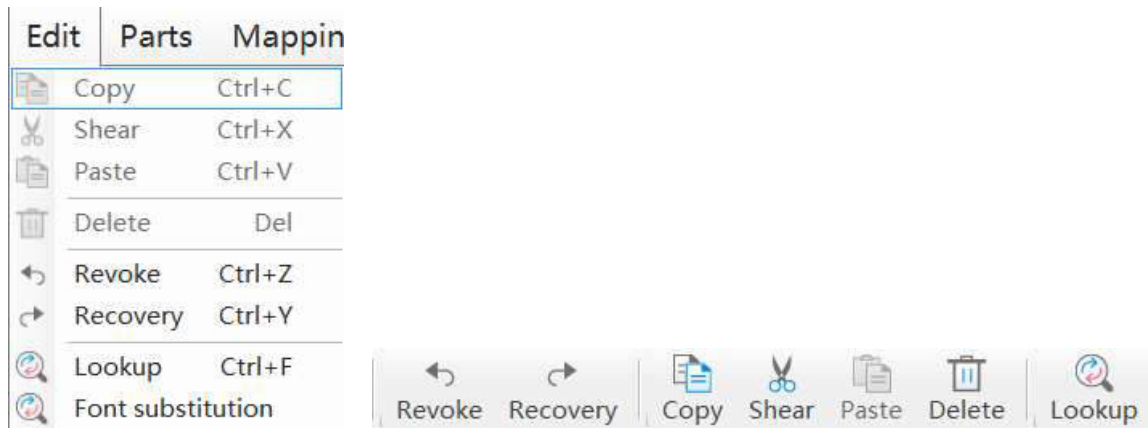

Copy	Select the target component and copy the component. The difference between the cutting operation and the cutting operation is that the original component no longer exists, but after the copy operation, the original component still exists. The shortcut key is Ctrl+C
Cut	Select the target object, cut it to the clipboard, shortcut keys Ctrl+X
Paste	It is the subsequent operation of "Cut" and "Copy". After cutting or copying the object component, execute the "Paste" operation to successfully transfer or copy the target component, shortcut keys Ctrl+V
Delete	Delete target object, shortcut keys Delete
Undo	Undo history operation, shortcut keys Ctrl+Z
Redo	Restore the history operation that was undone, shortcut keys Ctrl+Y

■ Lookup

This function is used to find and replace addresses in the project.

① Lookup

It is used for address search in the project. Enter the target address and click "Search" to display the screen, control ID and address number of the target address found in the lower blank area (as shown in the right figure below).

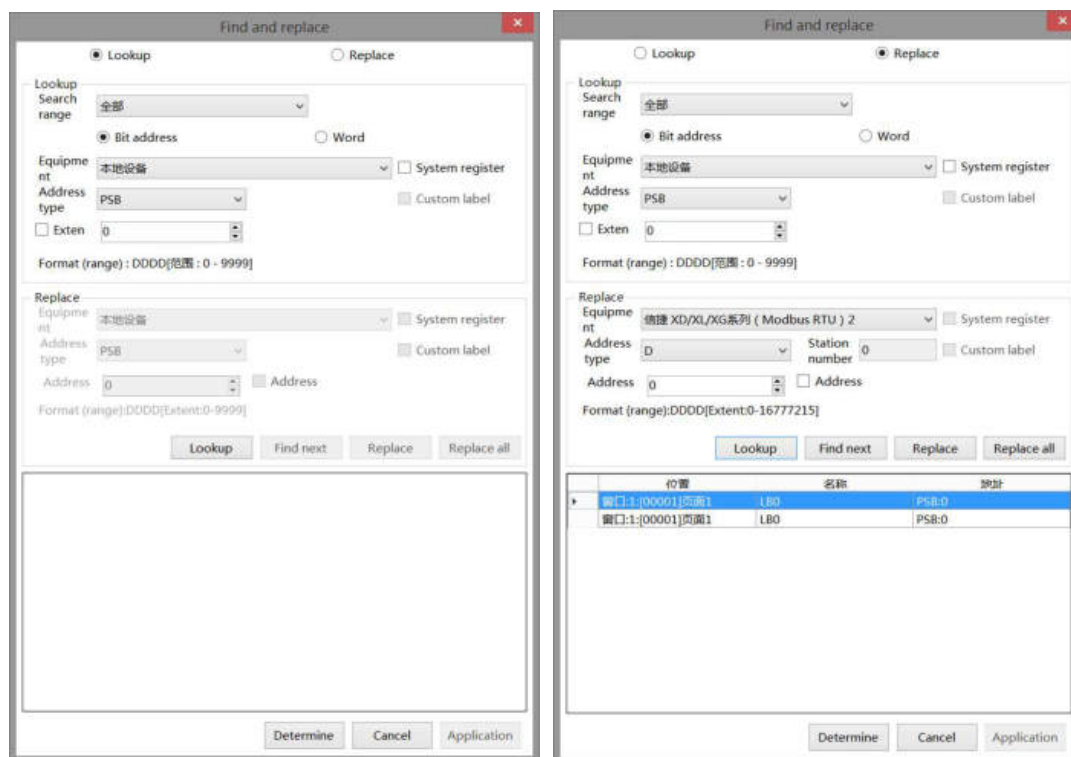

Look up search range	Select the search range. You can select a screen/window, or search in all the screens/windows. After selection, you will search within the selected range
Bit address	Set the search target as bit address
Word address	Set the search target as word address. Please note that only one of word address and bit address can be selected
Equipment	Select the name of the device to be searched, which can be selected from the local device (HMI internal) and the newly added devices in the COM port and Ethernet port devices
Address type	Select the address type. The address type here will change with the bit address or word address selected in the above search range. If the bit address is selected above, the address types displayed here are all bit address types. If the word address is selected above, the address type displayed here is the word address type.
Range	Set the detailed address number or address range to search. If "Range" is not checked, you only need to enter the address number to be searched in the rear input box, such as 0x0 under the modbus address; If "Range" is checked, two input boxes will appear. Enter the start address in the first input box and the end address in the second input box, such as 0x0~0x10. When the system performs the search task, it will search in 0x0~0x10, including the first and last addresses
System register	After checking, the address can only be selected from the HMI system address, the device must select "local device", and the specific system register name must be selected from the address type
Custom label	Select the address to find in the customized address label

② Replace

It is used to replace the address used in the project. It is usually used to change the address. The replacement needs to be used together with the search, and will be replaced in the found address. During operation, you need to first set the target address to be replaced in the search, and then set the replaced address in the replacement. Click "lookup". If you only need to replace one or more of them, you can click to select the control to be replaced in the search results, and click "Replace" to replace the selected control address with a new address. If you need to replace all controls, you can click Replace All to replace all the found controls with new addresses.

It should be noted that when "Range" is checked in the search, when using range search, an "Address Offset" option will appear in the replacement, as shown in the left figure below; After checking, the location of the original address will become "offset", as shown in the right figure below:

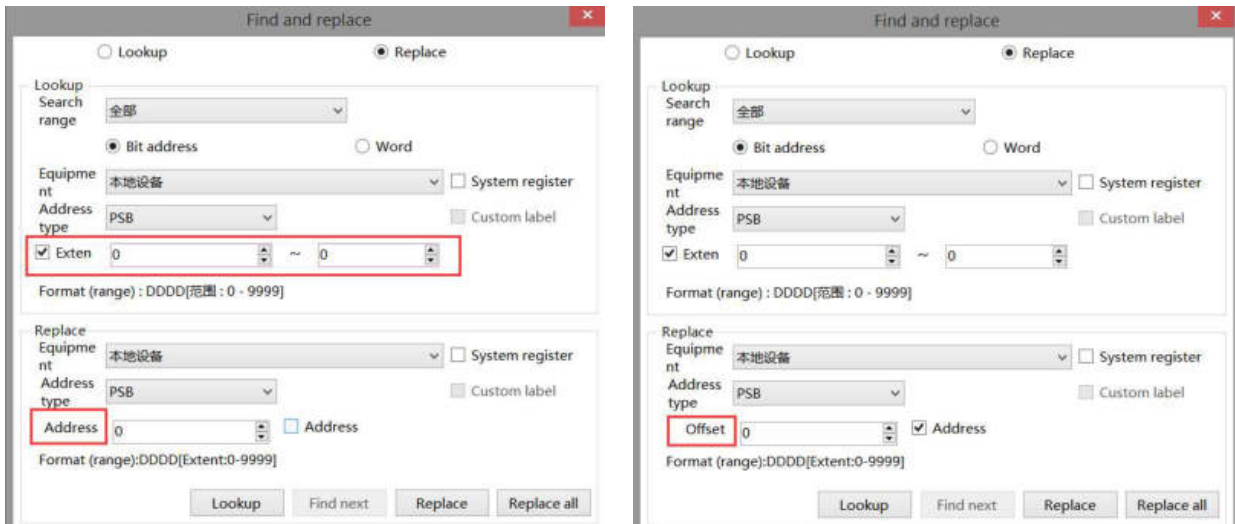

Case 1: When the range is checked and the address offset is not checked, all the addresses found in the range will be replaced with replacement addresses. If the search target is a~b and the replacement target is c, the replacement result is a~b replaced by c. For example, if the search range is set to 0x0~0x10 and the replacement address is 1x0, then all 0x0~0x10 addresses found will be replaced or replaced with 1x0.

Case 2: When the range is checked and the address offset is checked, there is an offset setting, that is, offset by the set offset in the search range. If the search target is a~b and the replacement offset is d, the replacement result is a+d~b+d. For example, if the search range is set to 0x0~0x10, and the replacement address type is set to 1x, then if the offset is set to 0, 0x0 will be replaced with 1x0, 0x1 with 1x1,..., 0x10 with 1x10. If the offset is set to 1, 0x0 will be replaced with 1x1, 0x1 with 1x2,..., 0x10 with 1x11. If the offset is set to a different value, the analogy will follow.

3-3-3. Parts

The component menu is mainly used for component editing, corresponding to the icon in the control window. Please refer to Chapter 4 for details.

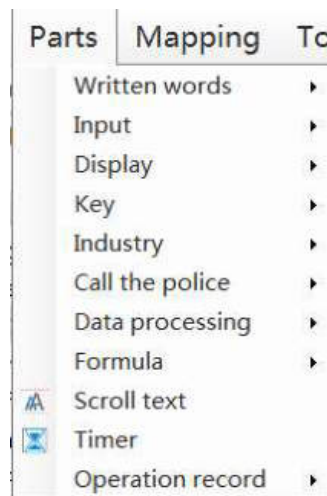

3-3-4. Mapping

This item includes basic tools such as straight line, circle, rectangle, arc, polygon, table, scale, QR code, picture, dynamic picture, and function canvas. There are corresponding shortcut icons in the control window, which can be realized through icons in the control window. Please refer to 4-1. drawing for specific use.

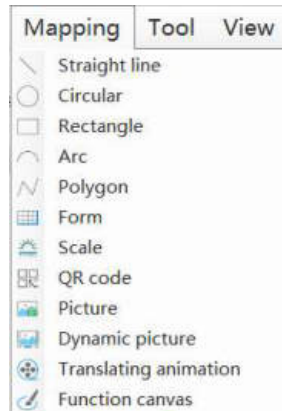

3-3-5. Tool

Used for address tag library settings and preferences.

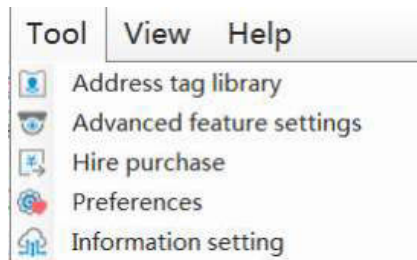

1. Address tag library

It is used to customize the address label, and can also view the meaning and address correspondence of the HMI internal system address in the library.

■ System register

It is used to display HMI system address information for users to view and use.

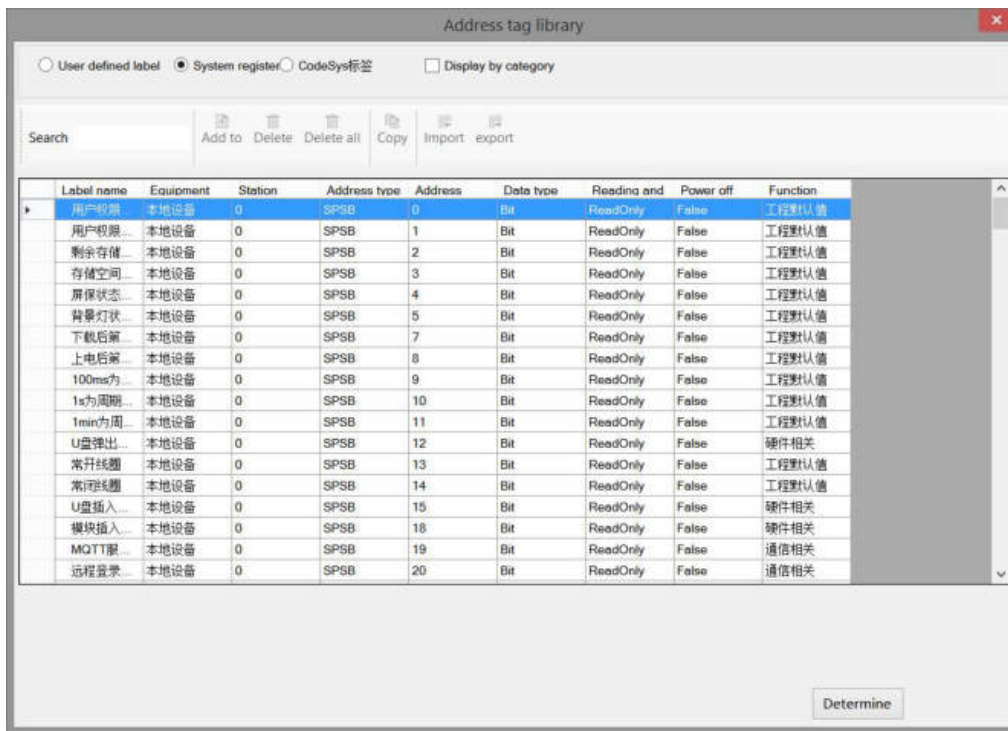

■ User defined label

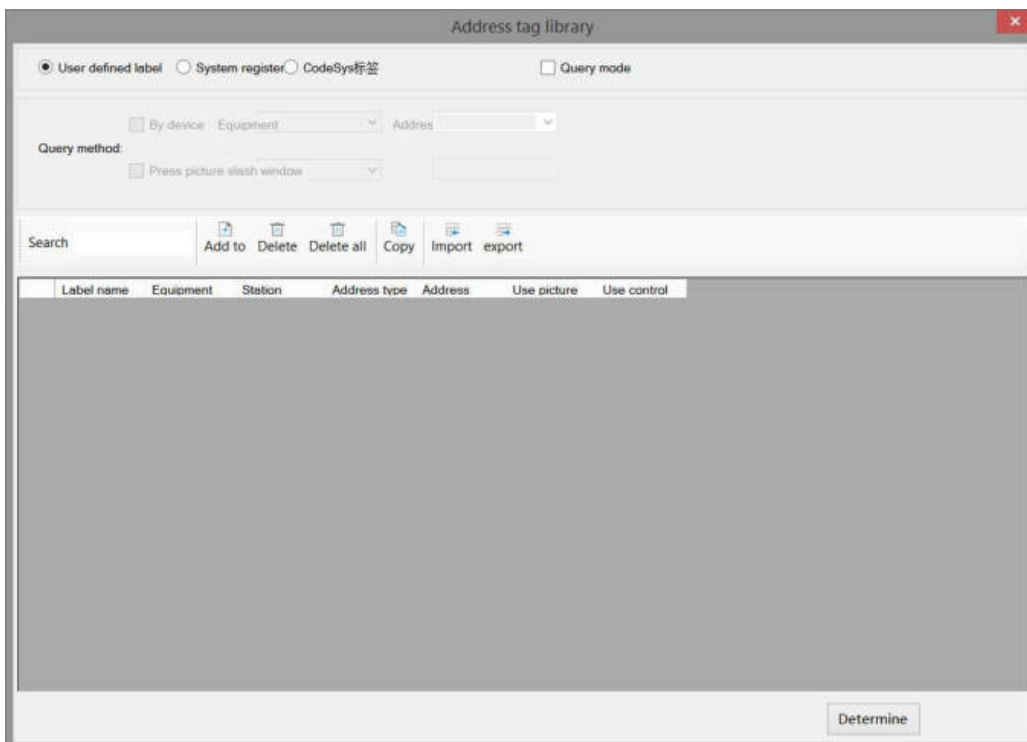

According to personal usage habits, create labels for HMI internal address or device address, and view the usage of each label address in this window. Refer to chapter 5-2 for specific usage methods.

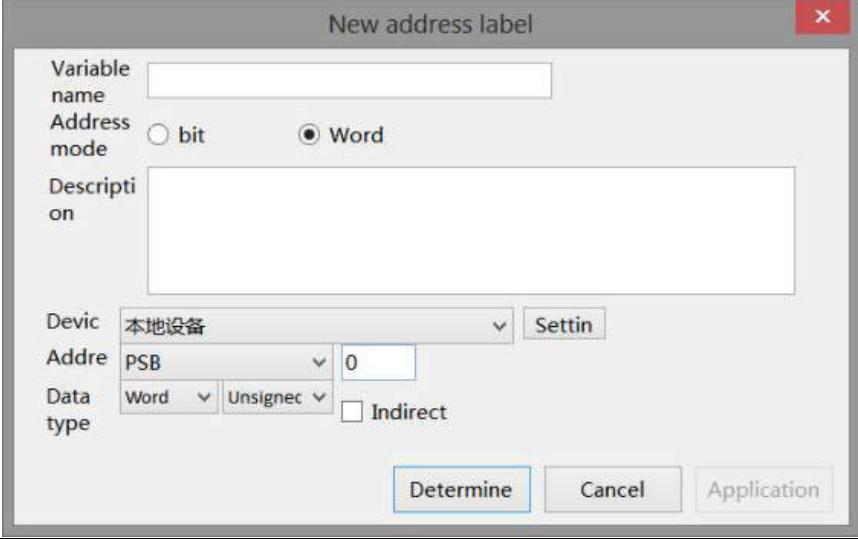
Add to	To add new address tag	
		
	Variable name	Set the label name for the address to be created
	Address mode	Select whether the address is a bit address or a word address
	Description	Set description information for the current address tag, which is optional
	Equipment	Select the device where the address is located. You can select the local device or the new device for the communication port
	Address	Set the address corresponding to the current label
Data type	Set the data type of the current address	
Delete	Delete the specified address label	
Delete all	Delete all added address labels	
Copy	Copy the specified address label	
Paste	This item will be displayed only when there is copied content. It is used to paste the copied address label at the specified location	
Import	Import the address table in CSV format of the path specified by the computer into HMI	
Export	Export the currently added address label to the specified path of the computer in CSV form	

2. Advanced feature settings

This function is not supported in the current version.

3. Hire purchase

Implement the installment payment of the equipment and lock the equipment for encryption. Refer to chapter 4-7-4. Installments for details.





4. Preferences

This section covers some preferences during project editing, including component address/ID display, grid and backup settings.

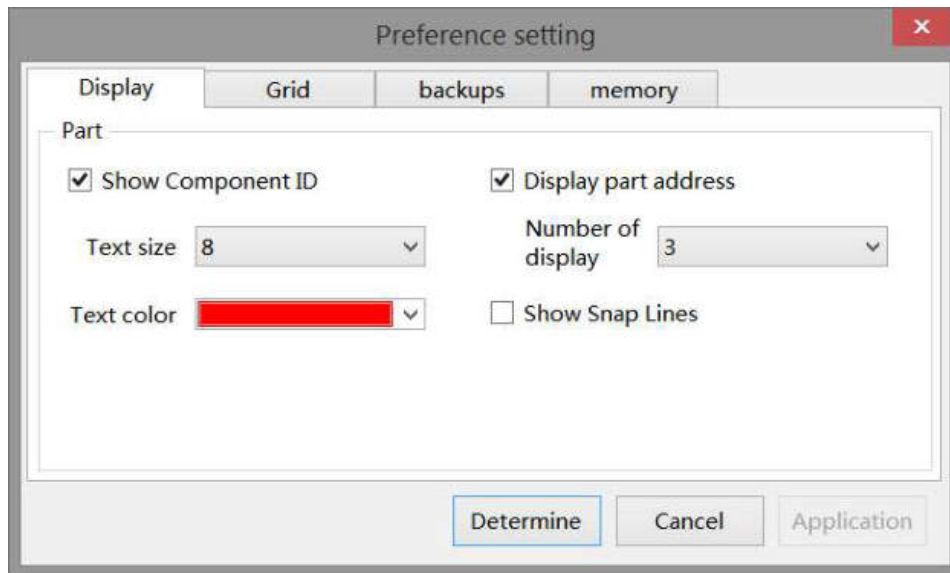
■ Display

It is used to set whether the component ID, address and text color used in the control are displayed.



<p>Display component ID</p>	<p>Set whether to display ID on the component. The ID content is fixed and cannot be modified. When checked, the ID will be displayed in the upper left corner of the component in the form of a corner mark. The difference between checking and not checking is as follows:</p> <p>Display the ID:  Not display the ID: </p>
<p>Character size</p>	<p>Set the text size of component ID. The larger the value, the larger the text</p>
<p>Display component address</p>	<p>Set whether to display the component address on the component. If checked, the address used by the component will be displayed in the upper left corner in the form of a subscript. The difference between checking and not checking is as follows</p> <p>Display the address:  Not display the address: </p>
<p>Text color</p>	<p>Set the display text color of component ID and component address, which is red by default and can be changed according to usage habits</p>
<p>Show alignment lines</p>	<p>When checked, when the mouse drags the component to move, the alignment line will be displayed when passing the aligned component. The dotted line box in the following figure represents the moving component, and the red line represents the alignment line aligned with the top of the button. If not checked, it will not be displayed</p> 

■ Grid

It is used to set the grid color and spacing in the screen editing area.

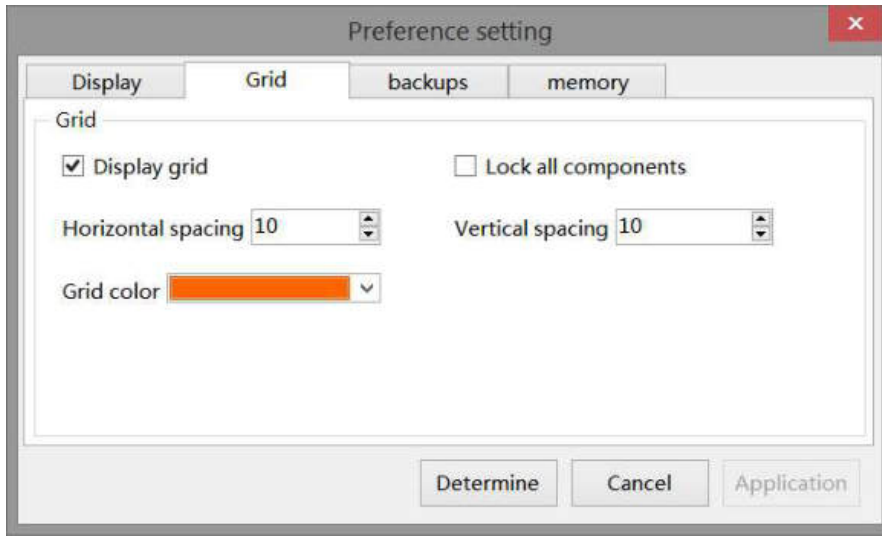

Display grid	Set whether to display grid in the screen editing area. By default, it is checked, that is, the grid is displayed. If you do not need to display grid, you can uncheck it. Or click  in the status bar.
Horizontal space	Set the density of the horizontal grid in the screen. The smaller the number, the denser the grid
Vertical space	Set the density of the vertical grid in the screen. The smaller the number, the denser the grid
Grid color	Set the color of the grid according to usage habits
Lock all the components	After checking, the component positions placed in all the pictures and windows of the current project will be locked. After locking, you cannot drag the mouse to move the position, but you can adjust the position by pressing up, down, left and right on the keyboard

For example, when the horizontal and vertical spacing is changed from "20" to "5", the difference is as follows:



Space: 20

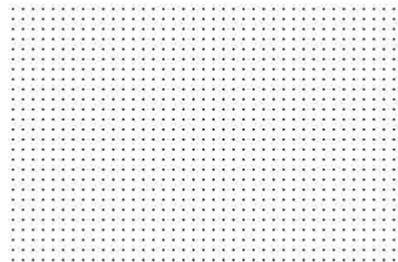

space: 5

■ Backup

It is used for backup and scheduled saving of project files.

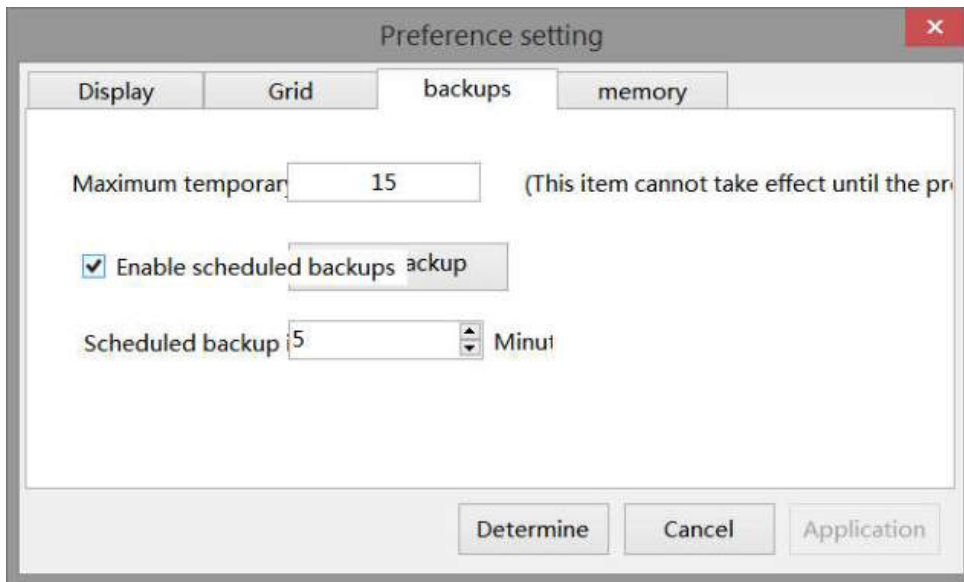

Maximum temporary files	Every time a project is saved, a backup file will be generated in the Temp folder of the installation path. When the maximum number of files set by the user is reached, the first backup project will be automatically overwritten. Click "Open Backup Folder" at the bottom right to view the backup program
Enable scheduled backups	After starting this item, you can set the automatic saving time in the "Scheduled Backup Interval" below to prevent data loss. When this item is not enabled, you need to manually save the project data

5. Information setting

- Download and upload program of PLC and HMI through the TS series HMI
- LAN and WAN VNC function
- Realize MQTT communication with Xinje Cloud, Alibaba Cloud, etc

Refer to chapter 8 for details.

3-3-6. View

The view menu is used to display various tools and columns. The blue box in front of each item name indicates that it is activated, while the box is not displayed, indicating that the item is not activated. Click "Restore Default" to restore the original interface of the software.

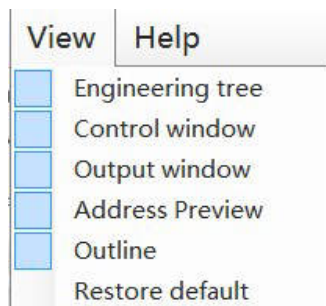

3-3-7. Help

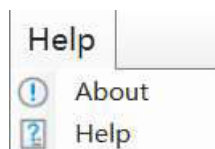

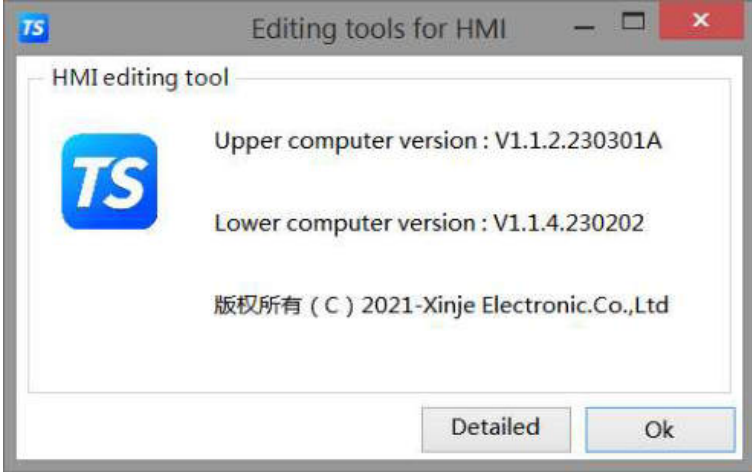

About	Version description and copyright description of HMI editing software 
-------	---

3-4. Tool bar

Toolbars are divided into software toolbars and picture toolbars, which involve some operations on components and pictures. When the mouse moves over relevant components during operation, relevant text prompts will appear. The specific allocation is as follows:



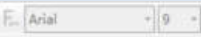



1. Software toolbar: it includes new, open, save, close, download, compile, online simulation, offline simulation and system settings for project related operations. For details, please refer to Section 3-3-1. It is used to undo, restore, copy, cut, paste, delete and search operations related to project editing. For details, please refer to chapter 3-3-2. As well as data sampling, alarm input, formula editing, and operation records for global operation of the project, please refer to chapter 4 for details.























 Full size display	When the screen editing area is enlarged or reduced, the default size can be restored by pressing this key
	Set the display font and size of the specified object
	Select different states for multi state controls such as indicators, dynamic text strings, multi state indicators, and buttons
	Select different languages for text display in multilingual label library

2. Screen toolbar: used to operate the selected component during screen editing. When the tool is gray, it is inoperable.



	Left aligned, horizontal left aligned
	Align Center, align Horizontal Center
	Right aligned, horizontal right aligned
	Top alignment, horizontal top aligned
	Middle alignment, horizontal middle aligned
	Bottom alignment, horizontal bottom aligned
	Lock: lock the specified compontnt to the position, which cannot be moved by dragging the mouse

	Unlock to move the specified component
	Move up one unit, where one unit is the vertical spacing of the grid in the preferences
	Move down one unit, where one unit is the vertical spacing of the grid in the preferences
	Move right one unit, where one unit is the vertical spacing of the grid in the preferences
	Move left one unit, where one unit is the vertical spacing of the grid in the preferences
	Vertical equal distance, set the vertical spacing of multiple selected components to be consistent
	Horizontal equal distance, set the horizontal spacing of multiple selected components to be consistent
	Combination
	Ungroup
	Equal width, based on the first selected component, set the width of all selected components to be consistent
	Equal height, based on the first selected component, set the height of all selected components to be consistent
	Move the specified part to the top
	Move the specified part to the bottom
	Move the specified part to the previous layer
	Move the specified part to the next layer
	Rectangle arrangement, multiple selected components are arranged according to the set rectangle
	Point arrangement
	Rectangle linear arrangement
	Circular linear arrangement
	Linear arrangement
	Polyline arrangement

3-5. Screen editing area

On the project screen editing platform, the user can right-click the selected part as follows:

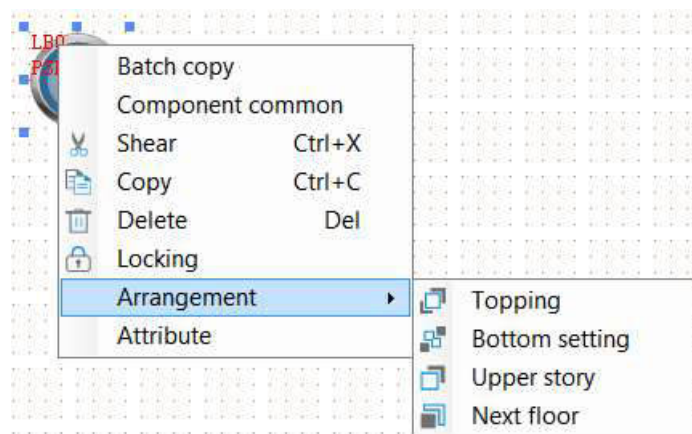

Batch copy	Batch copy the selected parts according to certain rules
Component common	Perform global common operations on the selected components, and realize special attributes through "component specific"
Cut	Cut the selected part
Copy	Copy the selected part

Delete	Delete the selected part
Locking	The relative position is locked, and the element cannot be moved after operation. The movement function can be realized by "unlocking"
Layer	When 2 or more parts are stacked, the display layer of the target part can be adjusted through the layer adjustment
Top	Move the part to the top layer
Bottom	Move the part to the bottom layer
Previous layer	Move the part to the previous layer
Next layer	Move the part to the next layer
Attribute	View or change "Display", "Font", "Color", "Position" and other operations of object components

3-6. Function area

You can drag the commonly used window here to switch to use. By default, this is the commonly used address preview and outline.

The address preview is used to view the usage of the device address added in the HMI or the communication port, so that you can intuitively check which addresses are used. Green in the address table indicates used, while gray indicates unused. Click to select an address, and you can see which pictures and controls the address is used in below. Click any component below to get its position. Double click to open the component properties directly.

The outline is used to display the Chinese names and English IDs of all components in the current screen. You can set the lock, unlock, hide and display of components here.

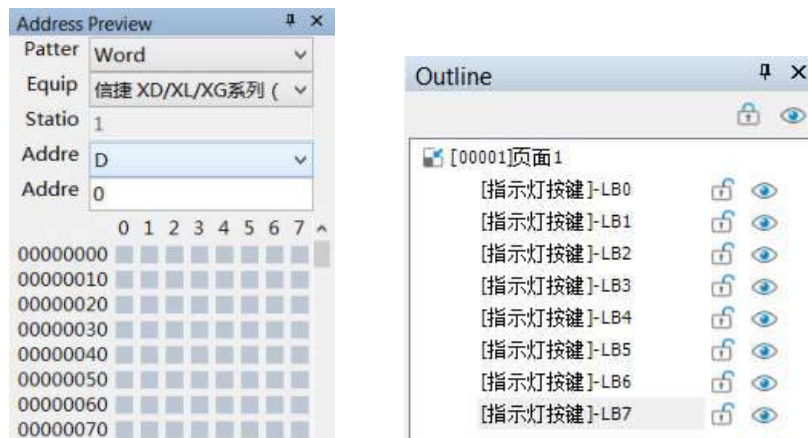

3-7. Component area

Display components and all components under the drawing menu, they are used for screen editing. For details, please refer to Chapter 4.

3-8. Output window

Display the compilation process and results of the current project.

If the project is compiled successfully, it can be downloaded normally.



If the project compilation fails, "Error occurred in compilation" will be displayed, and the cause of the error will be displayed in the error list, which can quickly locate the problem.



3-9. Status area

Display the current HMI model, COM port communication device, Ethernet port communication device, the coordinate position of the current mouse in the editing screen, the size of the zoom screen editing area, and the control grid display.



	Enlarge the screen editing area proportionally
	Scale down the screen editing area
	Whether to display grid

3-10. System setting

3-10-1. Parameter

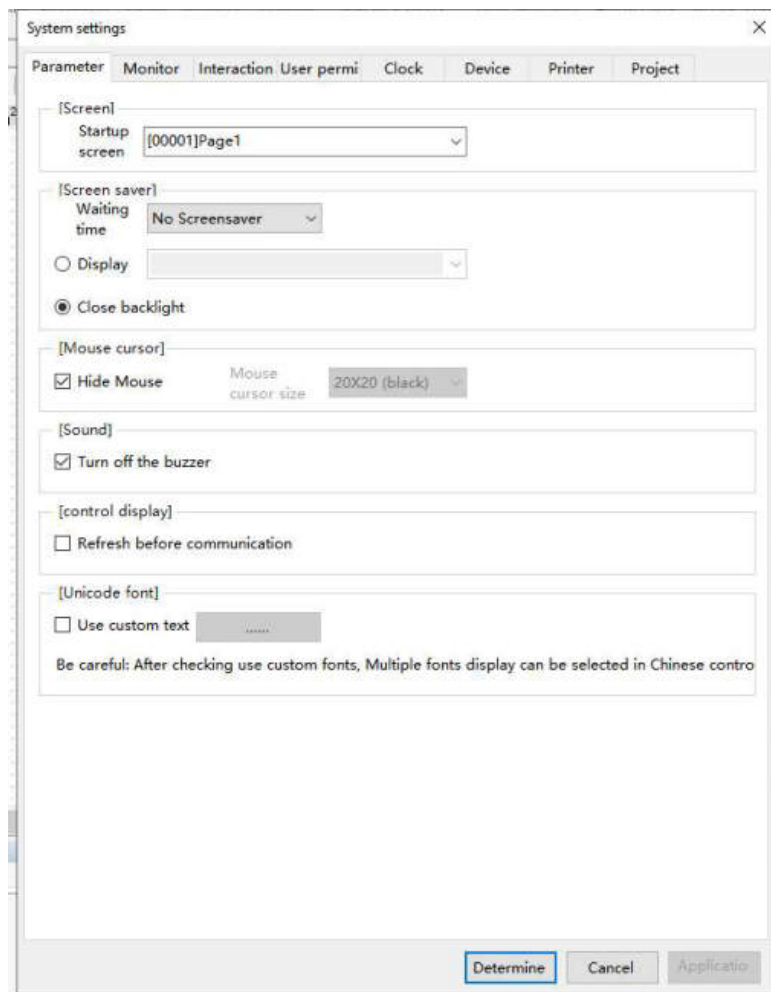

Screen	Enter the startup screen number, which is the screen that runs first when the HMI downloads the program and powers it on. It is usually the main screen of the program or the screen with the highest usage frequency.
Screen saver	This function is an automatic measure when the HMI is not triggered for a long time. After a period of non triggering operation, the touch screen can execute the setting to turn off the background light or jump to the designated screen.
Waiting time	Choose a time or choose no screen saver based on user needs.
Display	When the time conditions are met, jump to the object screen.
Close backlight	When the time conditions are met, turn off the background light. Note: Only one operation can be selected when turning off the background light and displaying the screen.
Hide mouse	When checked, the mouse cursor will not be displayed when clicking on the touch area
Mouse cursor size	Set the size and color of the mouse cursor display, and only black or white can be selected as the color.
Sound	Used to set whether clicking on the screen produces sound when the HMI is working normally. By default, there is sound output. If "Turn off the buzzer" is checked here, no sound will be

	emitted when clicking on the screen or triggering an alarm when the HMI is working.
Control display	Control loading logic, default not checked to communicate before loading control, checked to load control before refreshing data
Unicode font	After checking, users can use a custom Unicode font library. For the fonts needed in the lower computer, they can import the text after importing.

3-10-2. Monitor

Implement modification of human-machine interface model and display direction.

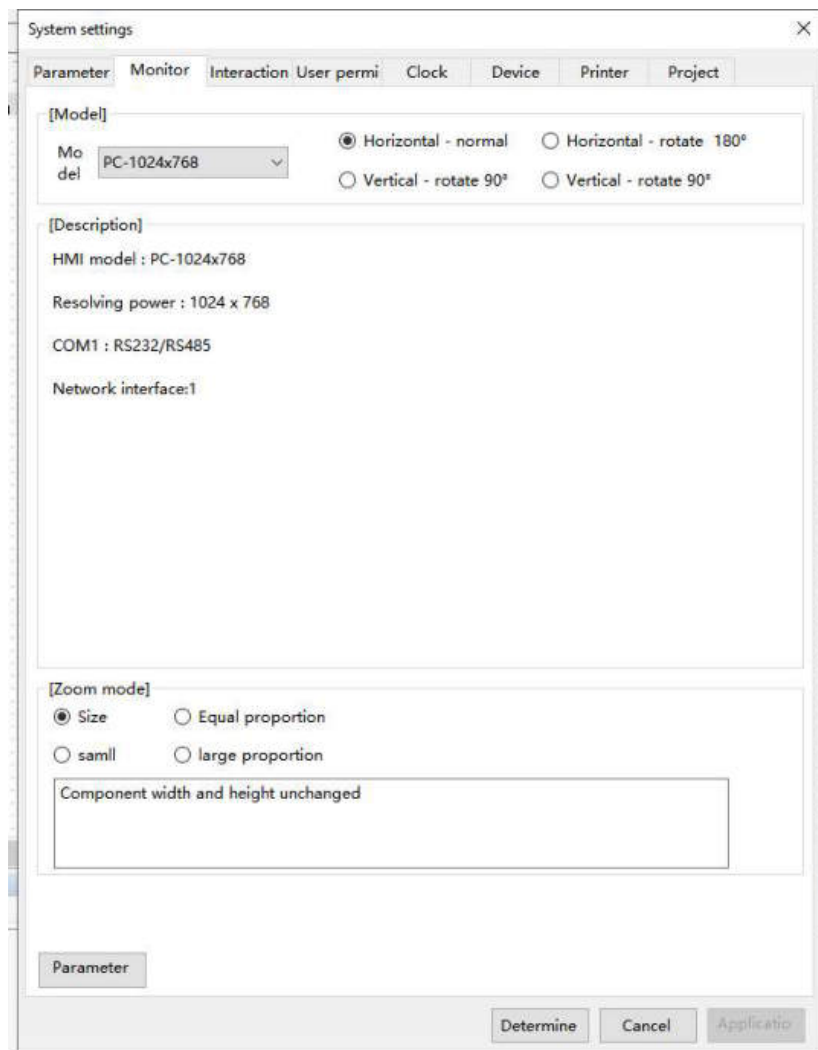

Model	Display the current HMI model and display direction; If you want to modify the monitor model, you can click "OK" to take effect after selecting a new monitor model and setting the display direction correctly; The default display direction is horizontal and normal. In order to adapt to various situations, we provide options such as rotating 180°, clockwise rotating 90°, and counterclockwise rotating 90°. Rotate the appropriate options according to the actual usage situation; (Default horizontal display. If switched to a different display direction, it will automatically jump to the calibration screen after downloading and require the user to recalibrate.).
Description	Display parameter information such as current screen size, resolution, brightness, color, memory, storage, USB port, COM port, etc

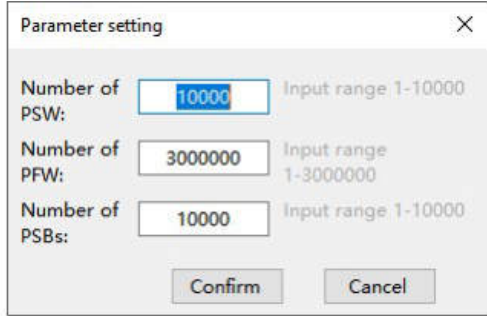
Zoom mode	When changing the monitor model, the ratio between the width, height, and size of the components in the screen and the size of the monitor.
Size	The width and height values of the components remain unchanged.
Equal proportion	The width and height values of the components are scaled according to the display's width and height ratio.
Small proportion	The component width and height values are scaled according to the small value of the display width to height ratio.
Large proportion	The component width and height values are scaled according to the large value of the display width to height ratio.
Parameter	Set the number of system registers and check the range of system registers. 

3-10-3. Interaction

Mainly realize the attribute connection between the screen and registers. Click "Interaction" and the settings item shown in the following figure will appear.

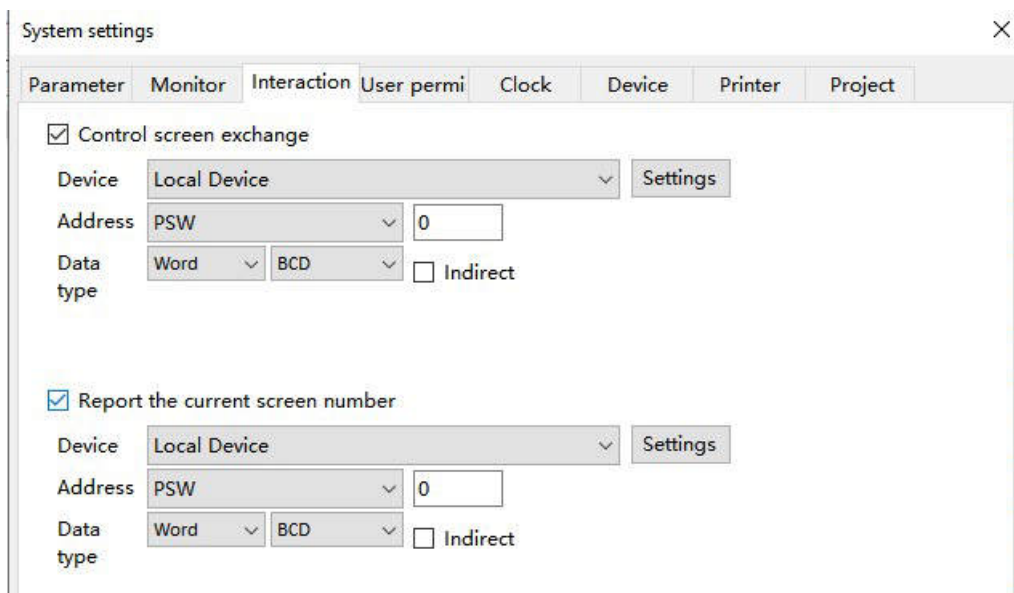

Control screen exchange	Jump to the screen based on the current register value. If the register value is 10, it indicates a jump to the screen number 10; Use PLC registers to control screen switching, and assign values to the registers to achieve screen switching.
Report the current screen number	Display the screen number of the current running screen. If the current operation interface is screen number 7, the register will display 7.
Device	The device port currently in communication.

Settings	Click to enter the address settings, and in the pop-up window, you can choose to use system registers or user-defined tags.
Address	Set the current register object type and address number.
Data type	Set the data type of the previously selected register, Byte represents 8-bit, Word represents 16-bit, DWord represents 32-bit, and DDWord represents 64 bits; In the second checkbox, you can select decimal, hexadecimal, unsigned numbers, floating-point numbers, etc.
Indirect	The current register address changes with the indirectly specified register value, i.e. $Dx[Dy]=D[x+Dy \text{ value}]$ ($x, y=0, 1, 2, 3\dots$), which is generally not used here.

3-10-4. User permission

The user permission function plays a role in project and data protection, improving program security; Permission settings are usually used for hiding and encrypting components or screens, and related operations are only carried out when the password is correctly entered.

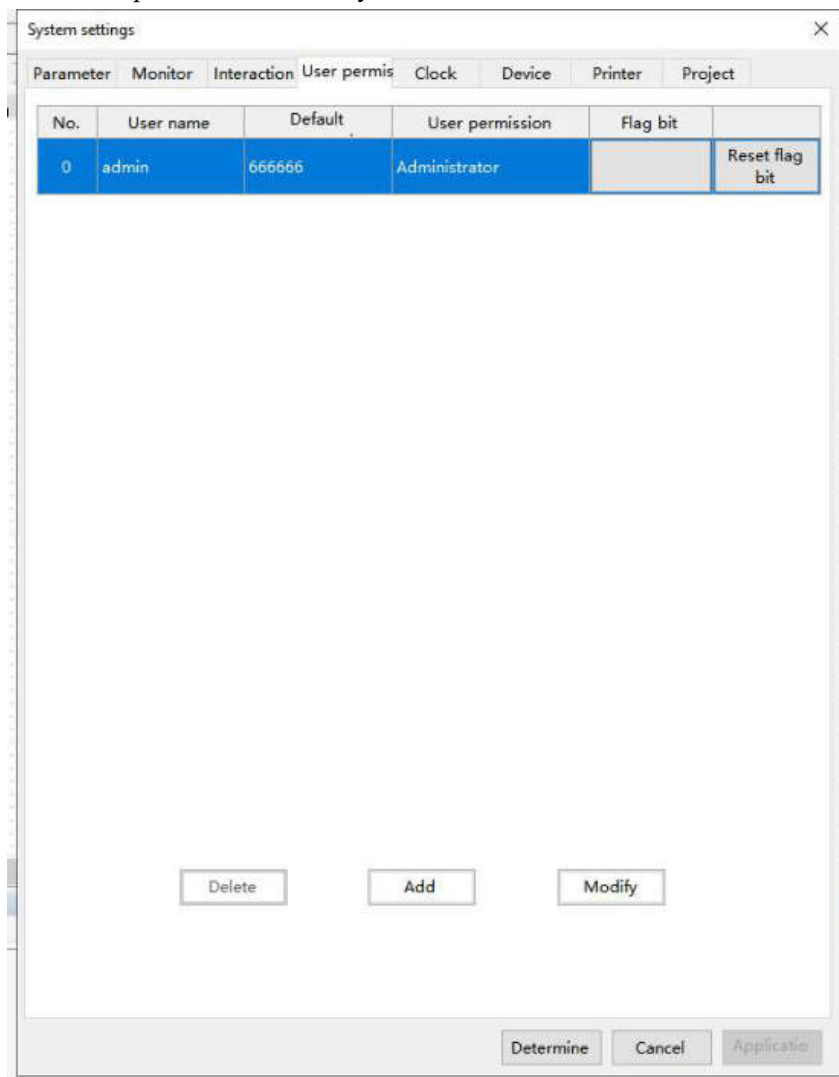

- User
Users are set up for their login accounts, and each user can set corresponding account name and password permissions, which are equivalent to a "password lock". Once a user has the corresponding permissions, they have the corresponding "password". A user can have a maximum of 30 permissions,

ranging from "permissions 1 to 30". Each permission is of equal level, and when adding a new user, the user can check the range of permissions that the user can operate according to their needs.

No.	User ID, mainly representing the current user ID
User name	The set user name
Password	The user password
User permission	The current user's permission level and the permissions they can operate on;
Flag bit	The corresponding permission flag for the user is set to ON after binding, and to OFF when not logged in. The user's login status can be operated by manipulating the flag.
Reset flag bit	Reset the bound flags.

- Permission

Permissions are operation items specific to the page/control. Taking the screen as an example, permissions are equivalent to a "password lock" for this page. When the user selects the corresponding permission, it is equivalent to locking the corresponding page. When the user wants to jump to the corresponding page or operate the corresponding control, the corresponding user must have this permission, otherwise they cannot operate.

- This collection explains the usage methods for the page/control security section.

(1) Screen/window security setting

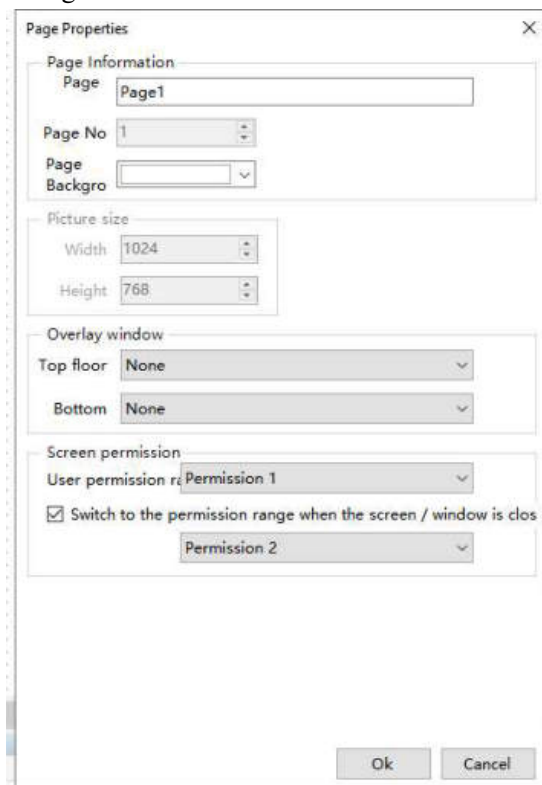

User permission range	Set controlled permission levels; To set the permissions for this component, you need to enter the password for the set permission level before the component can be used normally
Switch to the permission range when the screen/window is closed	After checking, when the screen is closed, the permission changes to the permission below. For example, opening this page for the first time requires permission 1. When the screen is closed, the permission for this screen switches from permission 1 to permission 2, and opening this page requires permission 2.

(2) Control related permission settings

User permission

Cancel permission after operation

A prompt window pops up when the user has no permission range

Hide this component when the user has no permission scope

User permission Permission1

Cancel permission after operation	After checking, when the operation is completed, the permission is cancelled and can be opened without permission
A prompt window pops up when the user has no permission range	After checking, when the permissions are insufficient, a corresponding window for insufficient permissions will pop up;
Hide this component when the user has no permission scope	When checked, the control will be hidden when the permissions are insufficient;



Password input range: 1-8 digits or character combinations.

- Instructions for use

If multiple users require different permissions, they can be added and corresponding permissions can be selected according to the above operation. The project has an administrator permission Admin by default, which has the highest level of administrator permission and can operate all permission protection functions. The following are two ways for users to log in:

- (1) Use function keys to call the user login interface for login

The operation steps are shown in the following figure:

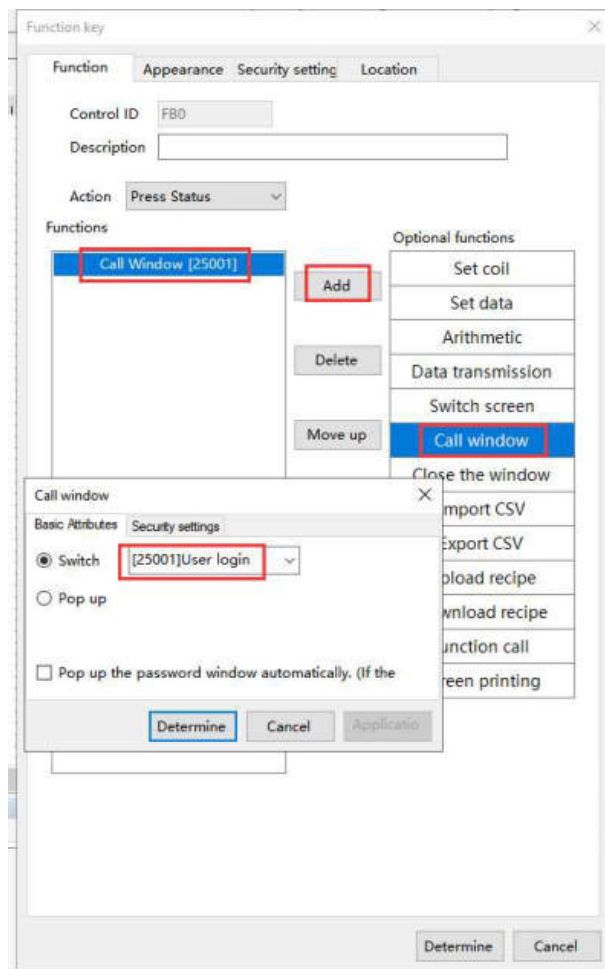

Click on the function key to call the user login window (as shown in the figure below), select the username to log in, enter the password correctly, and the login success will be displayed in the bottom left corner. If the password is entered incorrectly, the login failure will be displayed.

Using User1 as an example for introduction.

Select the username of User1 from the drop-down list, enter the correct login password 123456, and click the "Login" button to display the login successful (see left figure). At the same time, the password will be cleared. When the login is successful, permissions 1, 2, and 3 will be granted simultaneously; If you want to log out, you can also select the username of User1 from the drop-down list, enter the correct login password 123456, and click the "log out" button to display the successful logout (see the right figure). At the same time, the password will be cleared, or you can quickly log out by directly turning off the flag position. After successful logout, the user will not have the permissions they have (1, 2, 3).

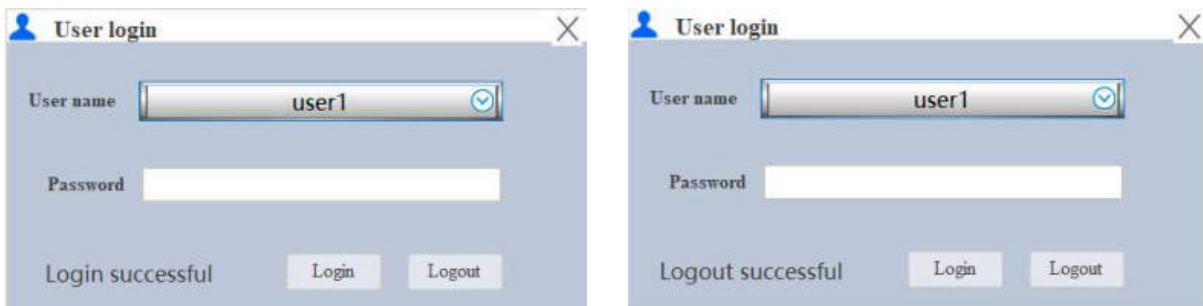

(2) Check "a prompt window pops up when the user has no permission range";

Taking the indicator key as an example, the settings are shown in the following figure:

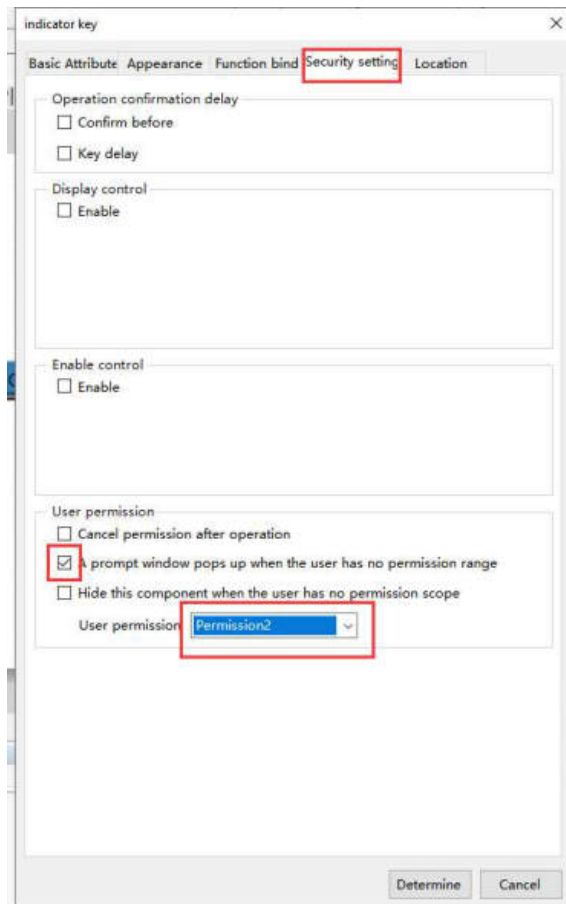

Download to the screen, click on the indicator key, and the following window will pop up:



Click "User Login" to enter the user login interface. The operation steps can be found in the login introduction of User1 above. If you click "OK", you can close this pop-up window.

- Use cases
 - Operator/administrator/manufacture type (permission level)

Having multi-level user names, operators can set partial screens, administrators have operator permissions and partial screens, and manufacturers can set all screens;

For the permission binding section of the screen/control: only the operator can operate the screen/control and set it to permission 1; Administrators and manufacturers can set the screen/control to permission 2; Only the manufacturer can operate the screen/control and set it to permission 3;

The corresponding user permission binding is: operator corresponds to check permission 1; Administrator checks permission 1 and permission 2; The manufacturer selects permission 1, permission 2, and permission 3;

- Single user permissions (independent of each other)

Having independent user names, corresponding permissions can be set and directly bound independently.

3-10-5. Clock

The touch screen comes standard with a clock function, which is mainly used to set the clock source and transmit the touch screen clock to externally connected PLC and other devices.

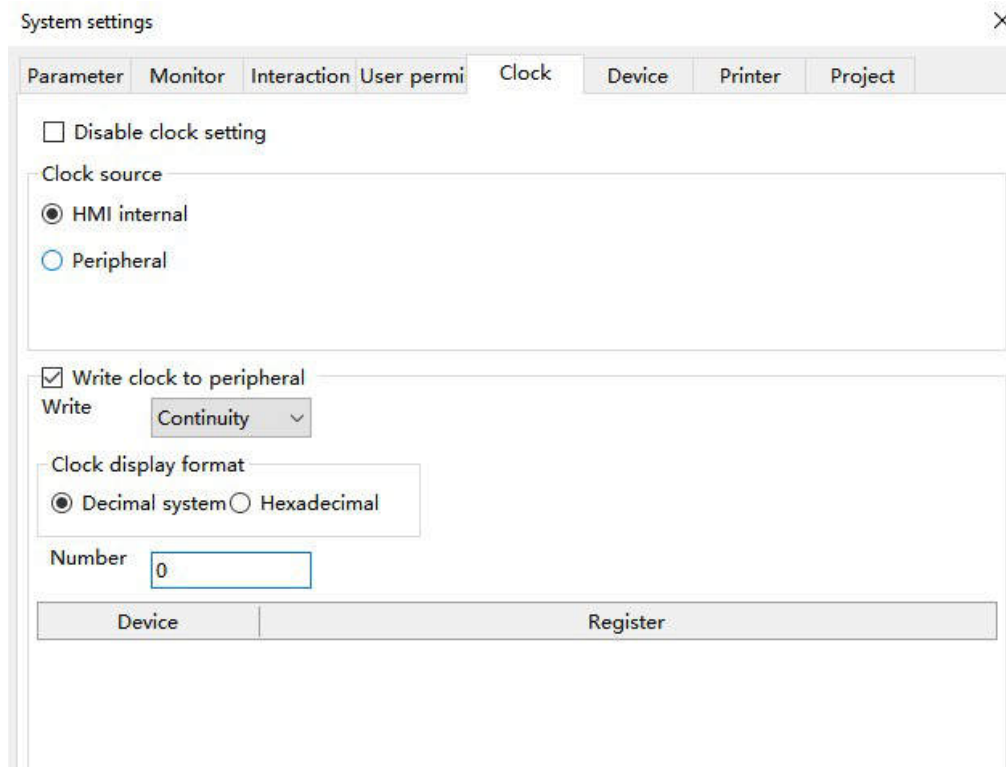

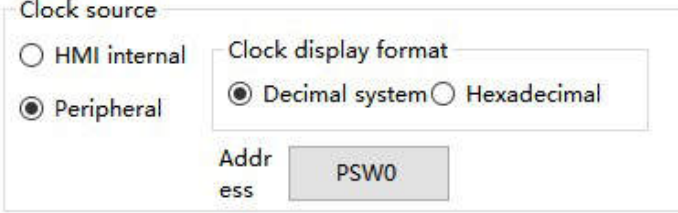
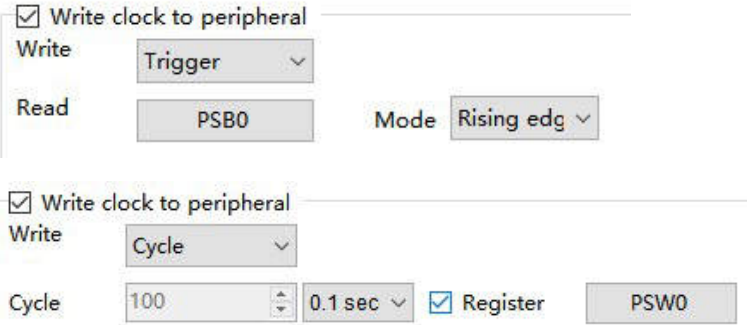
Disable clock setting	After checking, it will not be possible to modify the HMI internal clock for installment payments and other time encryption projects to prevent any impact on functionality after modifying the clock.
Clock source	<p>To set the clock source for the HMI, you can choose to use the HMI internal clock or import it from an external device. The default is the HMI internal clock. When selecting an external device, the following settings will appear.</p> 
Clock display format	<p>When setting the format for reading the clock from external devices, decimal or hexadecimal can be selected.</p> <p>Example: When communicating with the Xinje PLC through HMI, if the clock is selected to be read from an external device, and the Xinje PLC clock format is decimal, the clock display format here should also be selected as hexadecimal.</p>
Address	Set the first address for clock reading, set it to the HMI time, and the address requires one single word (16 bits) register each for year, month, day, hour, minute, and second, excluding the week. Example: If the address is set to D0, the values of the six registers from D0 to D6 will be read from D0 onwards, and used sequentially as year, month, day, hour, minute, and second.
Write mode	<p>After selecting "Write clock to peripheral", the method of exporting HMI clock can be set, which can be continuous, trigger, or cycle. The default is continuous transmission, which means that every second change can be written to the external address in real time; When selecting trigger or cycle, the transmission conditions need to be set, as shown in the following figure. It should be noted that when the writing method is cycle, the minimum cycle cannot be less than 100 milliseconds.</p> 
Clock display format	There are two ways to write the HMI internal clock: decimal and hexadecimal, so it is necessary to choose the external format based on the actual situation. After selecting, it will be written to the target register in the corresponding format.
Number of synchronization devices	Customize the number of HMI clocks written to external devices. If multiple devices are connected to the HMI simultaneously, the number of devices can also be set here. The table below will display the corresponding number of rows based on the number set here. The first address corresponding to each device needs to be set in the table below; Similar to reading from external sources above, writing to external devices is also divided into six registers: year, month, day, hour, minute, and second, excluding weeks. Example: If the address is set

to D0, D0~D5 will display year, month, day, hour, minute, and second in sequence, occupying 6 register addresses.

Write clock to peripheral

Write Continuity

Clock display format
 Decimal system Hexadecimal

Number 2

Device	Register
Device0	Settings
Device1	Settings

3-10-6. Device

Mainly set communication parameters between HMI and external devices such as PLC.

System settings

Parameter Monitor Interaction User permi Clock Device Printer Project

COM1 Xinje

COM2

Xinje XC RTU

Xinje XD RTU

New equipment

No	Device name	Equipment type	Port ID	Port type	Communication protocol	Station No.
0	Local Device	Local Device	-	-	-	0

Determine Cancel Applicatio

New equipment	Add different device types, select COM1/COM2/Net0 on the left, and click "New Equipment" to add a new device.
Device name	Customize the name of the added device. When adding multiple devices to the same serial port, the name cannot be duplicated.
Equipment type	The selected protocol name.
Port ID	The COM port where the device is located is automatically generated by the system and does not need to be set
Port type	The interface type selected when creating a new device is generally RS232, RS485, RS422, or Net.
Communication protocol	When in the serial port, parameters such as baud rate, data bits, parity, stop bit, etc. are displayed here; When in the Ethernet port, the IP address and port number of the device are displayed here. Double click to modify the parameters.
Station no.	The device station number cannot be duplicated when adding multiple devices to the same serial port.

3-10-7. Printer

The Xinje TS series HMI currently supports connecting micro printers through USB or serial port. Configure the connection parameters in System Settings - Printers, and the configuration items are shown in the following figure.

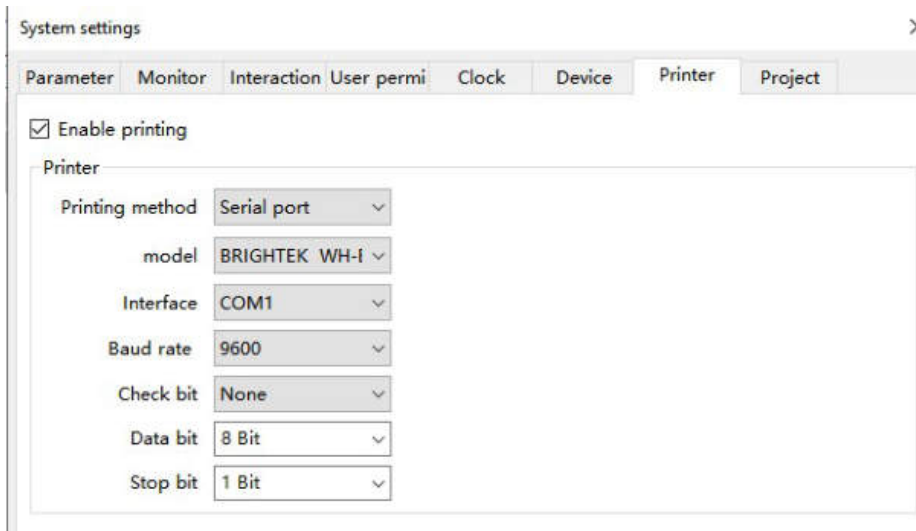

Printing method	Select the port for connecting the HMI to the printer; You can choose between serial port or USB.
Model	Select the printer brand and model; At present, the USB port only supports the "Brightek WH-E19" model; The serial port supports two models, "Prind" and "Brightek WH-E19".
Interface	Set the COM port for printer connection.
Baud rate	Set the baud rate for communication to be consistent with the printer's configuration.
Check bit	Set the communication parity bit to be consistent with the printer's configuration
Data bit	Set communication data bits to match printer configuration
Stop bit	Set the stop bit for communication to be consistent with the printer's configuration

After completing the configuration, you can find the "Print Area" control in the control area, click on it, select an area in the editing area, and configure the print trigger signal. Place the controls that need to be printed in this dashed area, and after triggering the printing signal, the content of the printing area will be printed out through the printer.

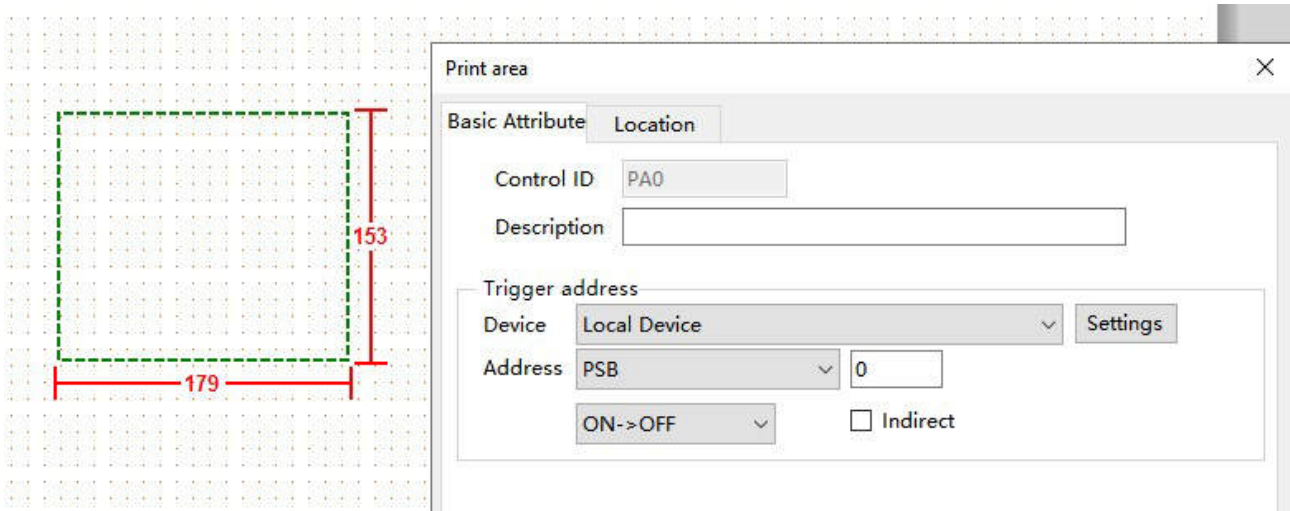

3-10-8. Project

This item is used to set the current project name, author, and comments. If the current project has been saved, the name item displays the name of the project and cannot be modified.

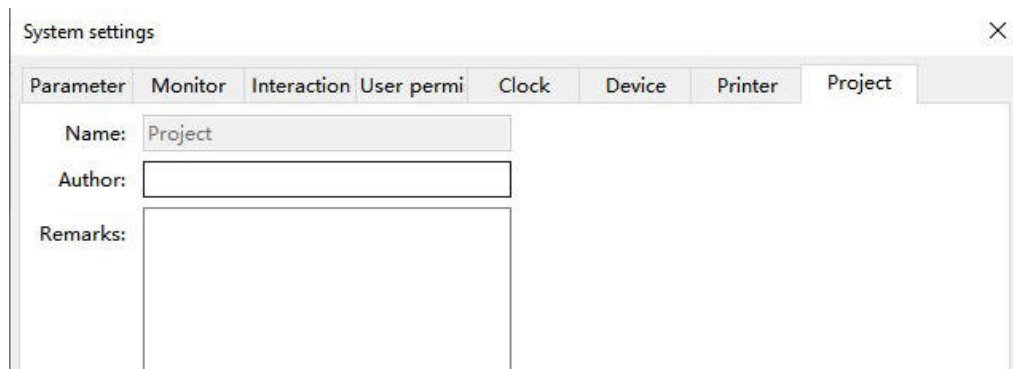

4. Components

4-1. Drawing

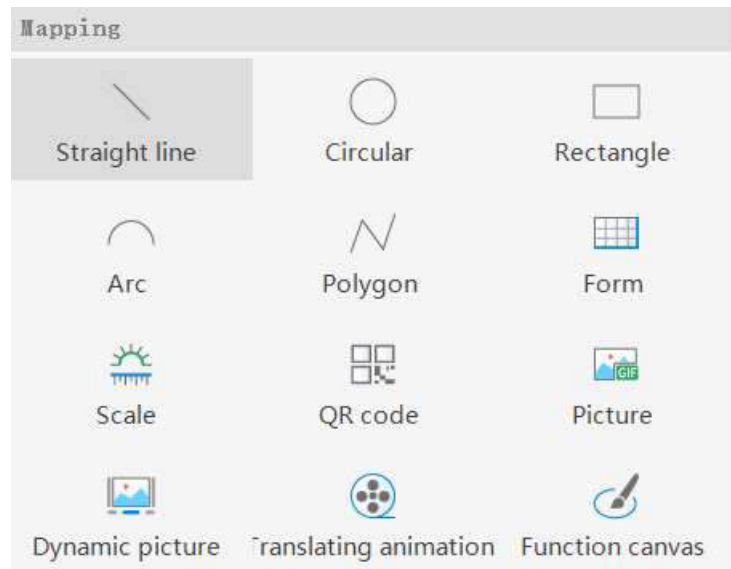

The drawing bar includes line, circle, rectangle, arc, polygon, table, scale, QR code, picture, dynamic picture, translation animation, and function canvas.

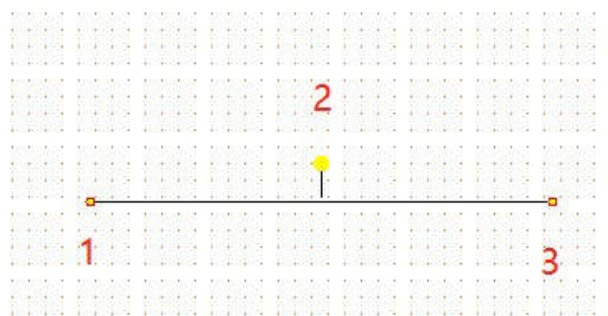

4-1-1. Straight line

1. Click Mapping/straight line or  icon, move the cursor to the screen, click the left mouse button at the starting point, drag the cursor to the end point, and then click the left mouse button (click the right mouse button or click ESC to cancel the placement) to complete the drawing of line segments. At the same time, a property box will pop up, and you can set it in the pop-up property dialog box.
2. Double click the drawn "line", or select "line", right-click, and select "attribute" to set the attribute.



- (1) During drawing, long press the Shift key to quickly draw horizontal or vertical lines
- (2) When the drawn line is selected, when the mouse is placed on point 1 or 3, the mouse shape changes from arrow to cross , long press the left mouse button to move left and right to change the length and rotation angle of the line. When the mouse is placed on point 2 (yellow point), the mouse shape changes from an arrow to a hand . Long press the left mouse button to move, and then rotate the whole figure with point 2 as the center.

■ Line property

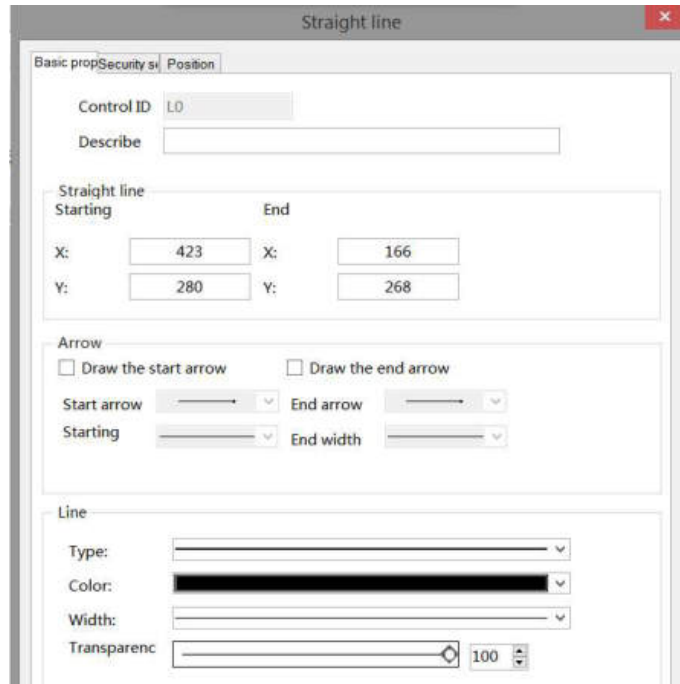

Control ID		It is used for system management and cannot be operated by users
Describe		Can be used to comment on the purpose of this component
Straight line	Starting	Set the X and Y values of the starting point of the line segment
	End	Set the X and Y values of the end point of the line segment
Arrow		Draw the starting arrow. Check this option to set the style and size of the starting arrow
		Draw the end arrow. Check this option to set the style and size of the end arrow
Line	Type	Set the type of line, including solid line, long dotted line, short dotted line, point line
	Color	Set the color of the line
	Width	Set the width of the line
	Transparency	Set the transparency of the line (the closer the slider is to the left, the lower the transparency percentage, and the more transparent the component is)

■ Security setting

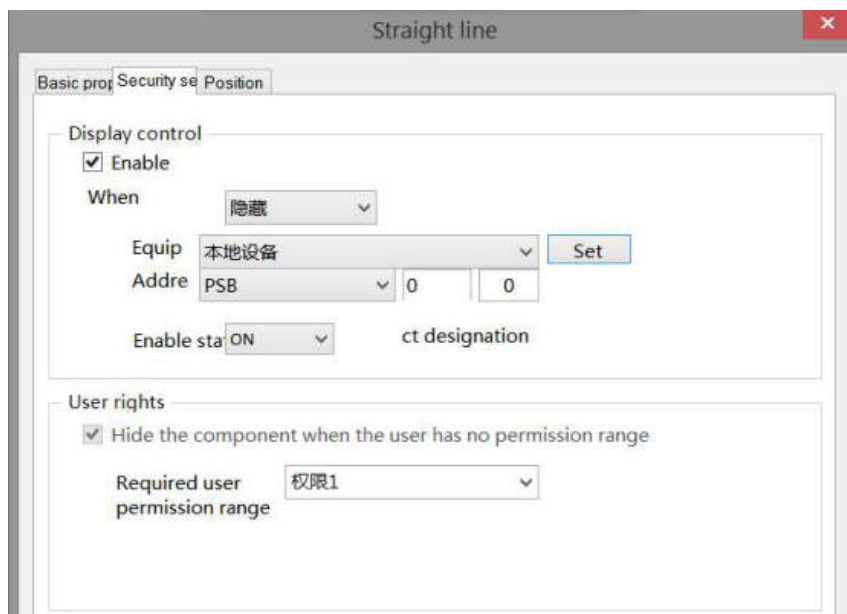

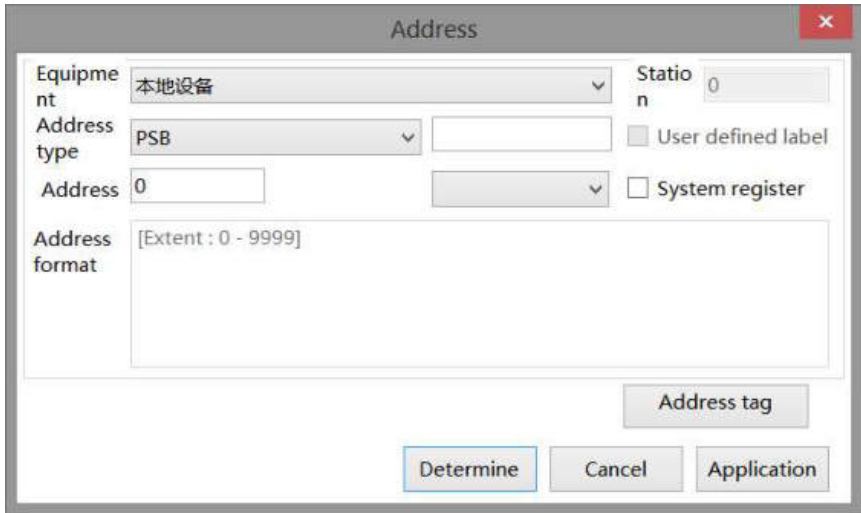

Display control	Use bits to control whether to display the part. When the condition is not met, the component will be hidden
Enable	When checked, display control will be enabled
When validation fails	When validation fails, it will hide the component
Equipment	Current communication device
Set	Click "Set" to enter the address setting interface, where you can set system registers and user-defined tags. You can click the address tag below or the project tree/library/address tag library to set the tags (see chapter 5-2 Address Tag Library for the use of address tag library and user-defined tags)
	
Address	Set the target coil for bit control
Enable status	Set ON status to be valid or OFF status to be valid
User rights	Set the component authority level. Set the permission of this component. You need to enter the password to use this component. When there is no permission for this component, this component is hidden

For example: if the equipment is set as shown in the above figure, the bit control is PSB0, and select “Hide the component when the user has no permission range”, and the enable status is ON, then when the status of PSB0 is ON, the component is normally displayed, and when the status of PSB0 is OFF, the component is hidden and not displayed.

■ Position



Position	Set the X and Y coordinate values of the line with the upper left point of the screen as the coordinate origin (0, 0)
----------	---

X coordinate	Set the X axis coordinate value of the line
Y coordinate	Set the Y axis coordinate value of the line
Size	Set the width and height of the line
Width (W)	Set the width of the line
Height (H)	Set the height of the line
Animation	Set whether the line can be moved
Lateral movement	Set the horizontal display position of the line according to the value of the register, that is, modify the X axis coordinate value. X axis coordinate value=X position+the value of the current register
Longitudinal movement	Set the vertical display position of the line according to the value of the register, that is, modify the Y axis coordinate value. Y axis coordinate value=Y position+the value of the current register
Locking	Set whether it can be moved during editing. When "Locking" is checked, it cannot be moved during editing. You can unlock it by unchecking this item, or you can set it by pressing the shortcut keys Lock  and Unlock  on the interface

4-1-2. Circular

1. Click "Mapping/Circular" in the menu or  icon in the drawing bar of the control window, move the cursor to the screen, press and hold the left mouse button at the starting point, drag the cursor to the end point, and release the left mouse button (click ESC to cancel the placement) to complete the circle drawing. At the same time, a property box will pop up, and you can set it in the pop-up property dialog box.
2. Double click the drawn "circle", or select "circle", right-click, and select "attribute" to set the attribute.

■ Property

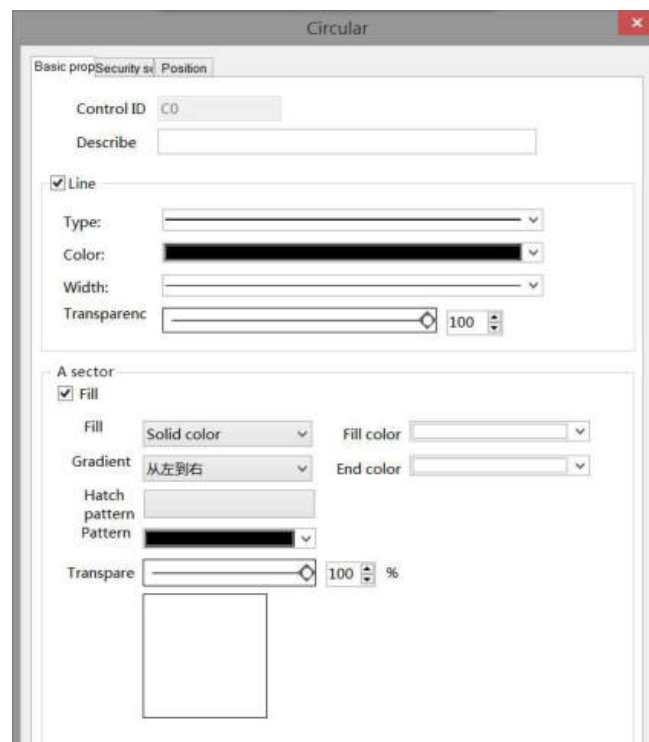

Control ID	It is used for system management component and cannot be operated by users
Describe	Can be used to comment on the purpose of this component

Line	Type	Set the line type of the circle, including solid line, long dotted line, short dotted line, and point line
	Color	Set the border color of the circle
	Width	Set the line width of the circle
	Transparency	Set the line transparency of the circle (the closer the slider is to the left, the lower the transparency percentage, the more transparent the line is)
Sector	Fill	After checking "Fill", you can set the fill color, fill style and transparency of the circle
	Fill pattern	Can be filled with solid colors, gradients and patterns
	Transparency	Set the transparency of the circle by sliding the slider (the closer the slider is to the left, the transparency percentage is lower, the more transparent the filled area is)

transparency 100% transparency 50% transparency 0%



The set fill style, color and transparency can be previewed in the box below the transparency.

■ Security setting

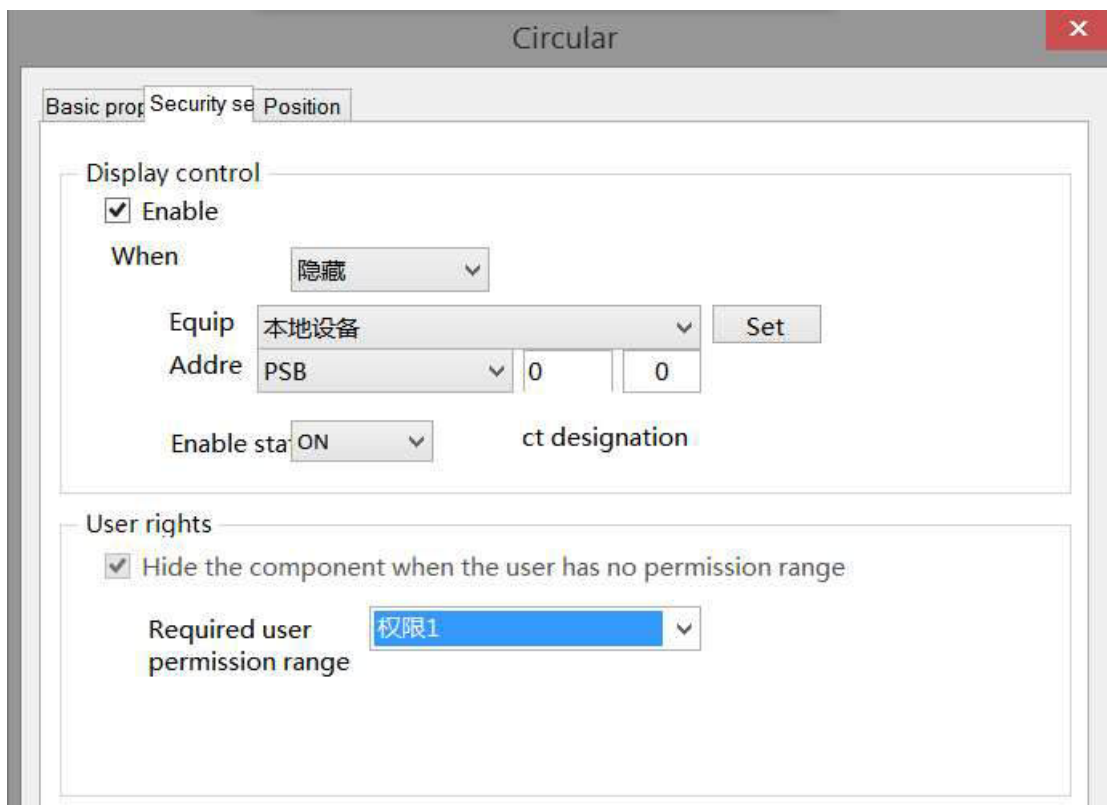

Refer to chapter 4-1-1 straight line for security setting.

■ Position

Refer to chapter 4-1-1 straight line for position.

4-1-3. Rectangle

1. Click "Mapping/Rectangle" in the menu bar or  icon in the control window's drawing bar, move the cursor to the screen, press and hold the left mouse button at the starting point, drag the cursor to the end point, and release the left mouse button (click ESC to cancel the placement) to finish the rectangle drawing. At the same time, a property box will pop up, and you can set it in the pop-up property dialog box.
2. Double click the drawn Rectangle/Rounded Rectangle, or select Rectangle/Rounded Rectangle, right-click, and select attribute.

■ Property

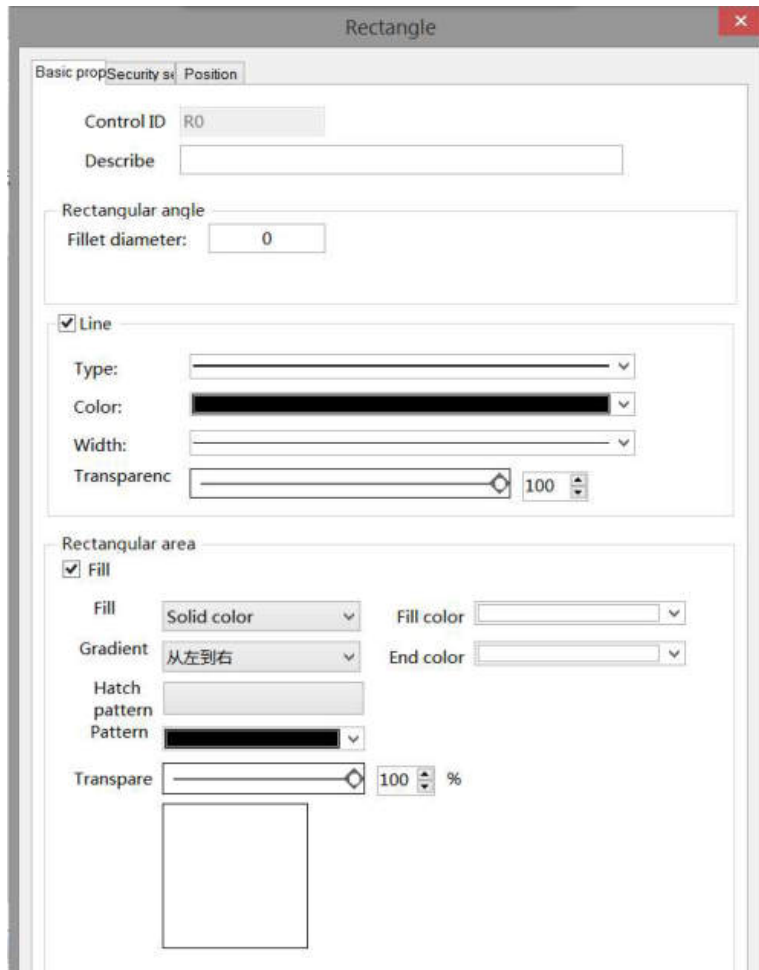

Control ID		It is used for system management component and cannot be operated by users
Describe		Can be used to comment on the purpose of this component
Rectangular angle	Fillet diameter	Set the fillet diameter (0-100) to 0, which is a rectangle. The larger the value, the larger the fillet diameter (the upper limit of the fillet diameter varies according to the size of the rectangle placed)
		 <p>Fillet diameter 83 Fillet diameter 40 Fillet diameter 0</p>
Line	Type	Set the line type of the rectangle, including solid line, long dotted line, short dotted line, and point line

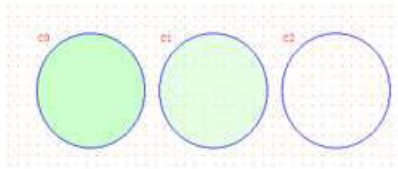
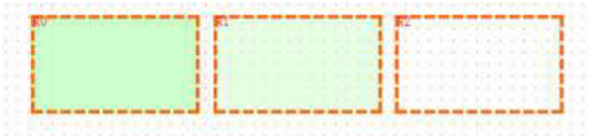
	Color	Set the line color of the rectangle
	Width	Set the line width of the rectangle  Transparency 100% 50% 0%
	Transparency	Set the transparency of rectangular lines (the closer the slider is to the left, the lower the transparency percentage, and the more transparent the lines are)
Rectangular area	Fill	After checking "Fill", you can set the fill color, fill style and transparency of the rectangular area
	Fill pattern	Can be filled with solid colors, gradients and patterns
	Transparency	Set the transparency of rectangle/rounded rectangle by sliding the slider (the closer the slider is to the left, the lower the transparency percentage, and the more transparent the filled area is)  Transparency 100% 50% 0%



The set fill style, color and transparency can be previewed in the box below the transparency

■ Security setting

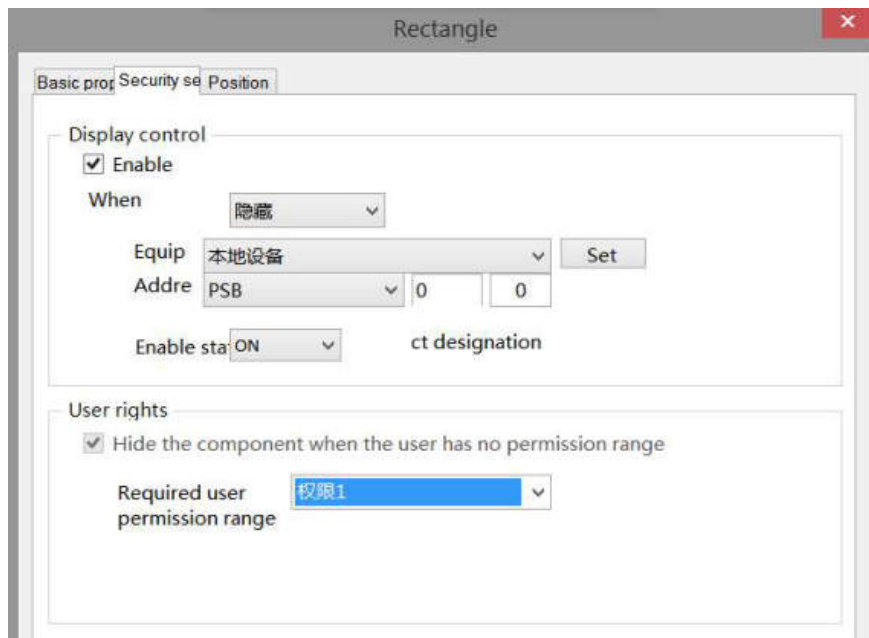

Same to chapter 4-1-1. Straight line security setting.

■ Position

Same to chapter 4-1-1. Straight line position part.

4-1-4. Arc

Click the "Mapping/Arc" icon in the menu bar or the  icon in the control window's drawing bar, move the cursor to the screen, click the left mouse button at the starting point, drag the cursor to the end point, and then click the left mouse button to complete the arc drawing. At the same time, a property box will pop up, and you can set it in the pop-up property dialog box. The difference between arc and sector is whether they are closed. Double click the drawn Arc, or select the Arc, right-click, and select attribute.

- Basic property

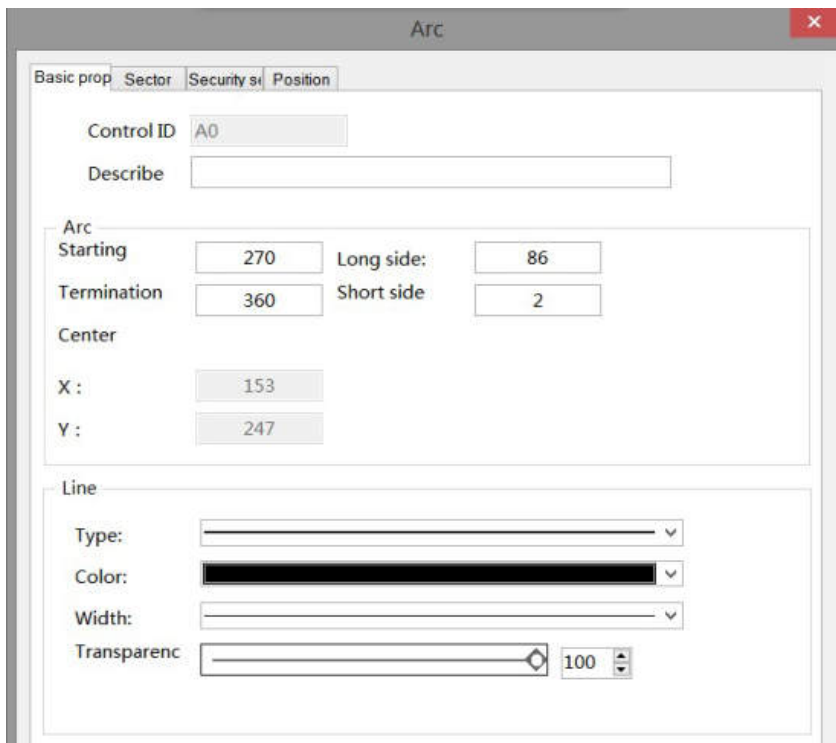

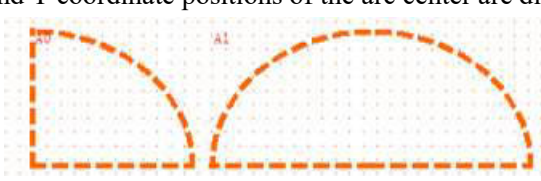
Control ID		It is used for system management component and cannot be operated by users
Describe		It can be used to remark the purpose of this control
Arc	Starting	Take the arc center as the base point, take the right direction of the horizontal line passing through the base point as the horizontal 0°, and the angle between the line passing through the base point and the starting point and the horizontal 0°
	Termination	Take the arc center as the base point, take the right direction of the horizontal line passing through the base point as the horizontal 0°, and the angle between the line passing through the base point and the end point and the horizontal 0°
	Long side	Set the long side of the arc
	Short side	Set the short side of the arc
	Center	The X and Y coordinate positions of the arc center are displayed and cannot be modified  Start angle 0° Start angle 0° End angle 90° End angle 180°
Line	Type	Set the line type of arc, including solid line, long dotted line, short dotted line and point line

	Color	Set the line color of the arc
	Width	Set the line width of the arc
	Transparency	Set the transparency of the line (the closer the slider is to the left, the lower the transparency percentage, the more transparent the line is)

■ Sector

The arc start point, end point and arc center point are connected to form a closed figure, that is, a sector.

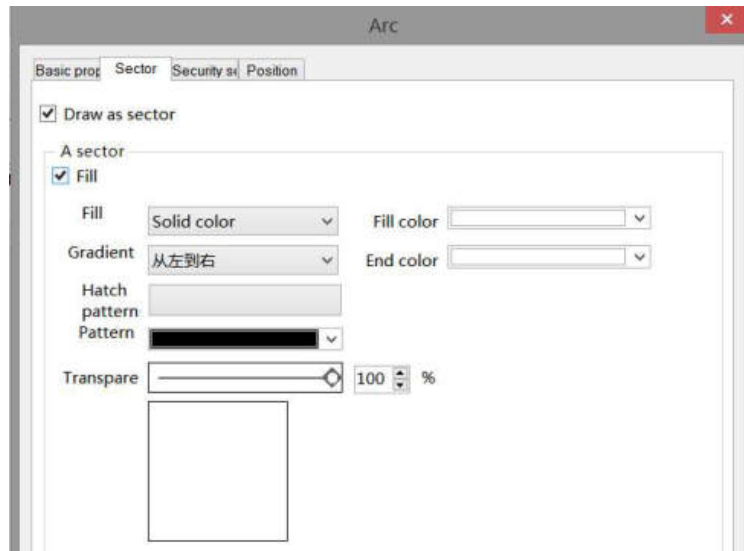

Sector	Select “draw as sector”, and set the fill option
Fill	Set the fill color, fill style, and transparency of the sector
Pattern	Can be filled with solid colors, gradients and patterns
Transparency	Set the transparency of the sector by sliding the slider (the closer the slider is to the left, the lower the transparency percentage, and the more transparent the component is)

Transparency 100% 0%



The set fill style, color and transparency can be previewed in the box below the transparency

■ Security setting

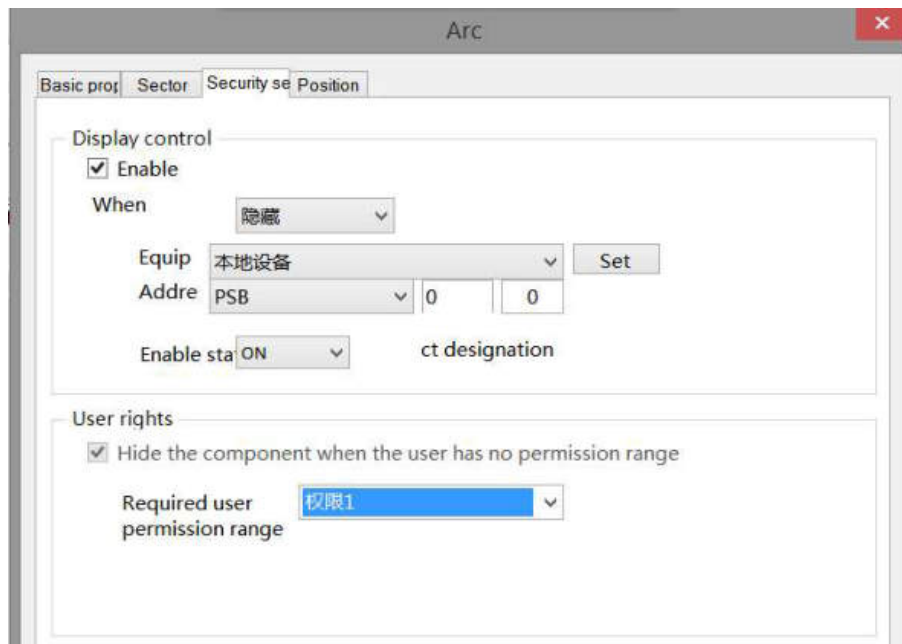

Same to chapter 4-1-1. Straight line security setting

■ Position

Same to chapter 4-1-1. Straight line position part.

4-1-5. Polygon

1. Click the "Mapping/Polygon" icon in the menu bar or the  icon in the control window's drawing bar, move the cursor to the screen, press the left mouse button at the starting point, drag the cursor to move, and determine the positions of the following endpoints in turn. Double click the left mouse button (click the right mouse button or cancel the placement with the ESC key) to finish the polyline drawing. At the same time, a property box will pop up, and you can set it in the pop-up property dialog box. The difference between polylines and polygons is whether they are closed.
2. Double click the drawn Polyline/Polygon, or select Polyline/Polygon, right-click, and select Attribute.

■ Basic property

Polyline

Polygon

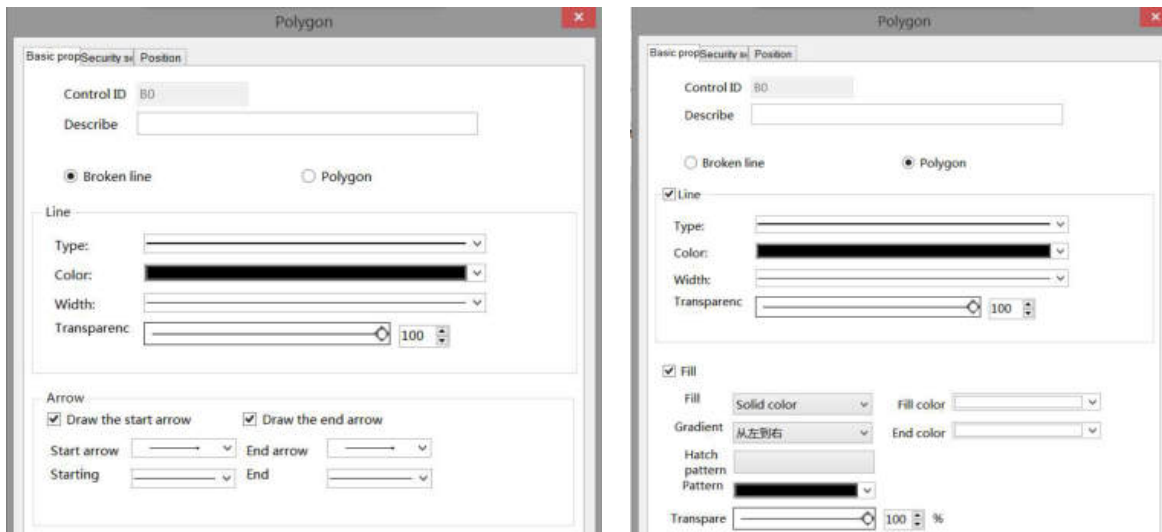

Control ID	It is used for system management component and cannot be operated by users	
Describe	It can be used to remark the purpose of this control	
Broken line	Set whether it is a polyline	
Polygon	When you select a polygon, the polyline automatically connects the start point and end point to generate a polygon. You can set the fill color, fill style, and transparency of the polygon	
Line	Type	Set the line type, including solid line, long dotted line, short dotted line, and point line
	Color	Set the line color
	Width	Set the line width
	Transparency	Set the transparency of the line (the closer the slider is to the left, the lower the transparency percentage, the more transparent the line is)
Arrow	Draw the start arrow	After checking this option, you can set the style and size of the starting arrow
	Draw the end arrow	After checking this option, you can set the style and size of the end arrow
Fill	Set the fill color, fill style and transparency of polygons	
Pattern	Can be filled with solid colors, gradients and patterns	
Transparency	Set the transparency of polygons by sliding the slider (the closer the slider is to the left, the lower the transparency percentage, and the more transparent the filled area is)	
	<p>Transparency 100% 50% 0%</p>	



The set fill style, color and transparency can be previewed in the box below the transparency

- Security setting

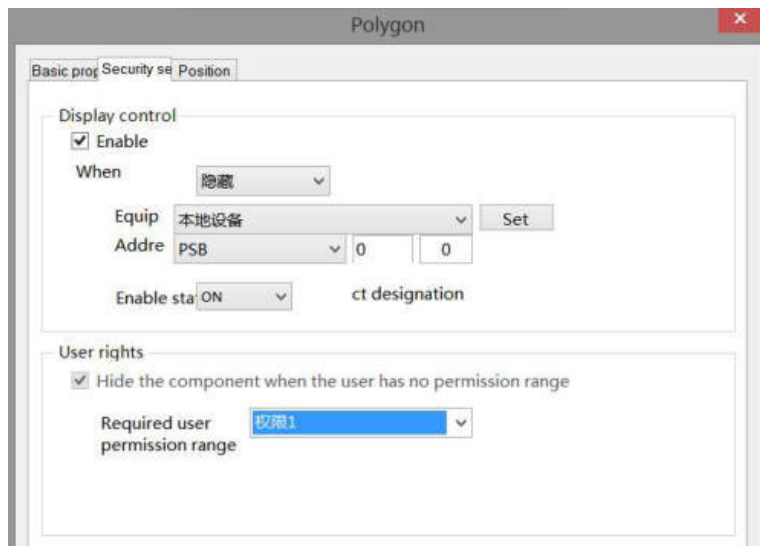

Same to chapter 4-1-1. Straight line security setting.

- Position

Same as chapter 4-1-1. Straight line position part.

4-1-6. Form

1. Click "Mapping/Form" in the menu bar or  icon in the drawing bar of the control window, move the cursor to the screen, click the left mouse button to place, click the right mouse button or click ESC to cancel the placement. Modify the length and width of the border through the border points.
2. When setting attributes, you can set them in the attribute box that pops up when placing components. You can also double-click the drawn "Table" or select "Table" and right-click to select Attribute.

- Basic property

Control ID	It is used for system management control and cannot be operated by users	
Describe	Can be used to comment on the purpose of this component	
Interval	Rows	Set the number of rows in the table. The default value is 3
	Columns	Set the number of columns in the table. The default value is 3
	Contour	Set whether the table is equal in height
	Equal width	Set whether the table is equal in width
Outer frame	Style	Select the style of the outline, including solid line, long dotted line, short dotted line, and point line
	Color	Set the color of the outer border
Grid	Show row separator	Set the color and style of row separator
	Show column separator	Set the color and style of column separator
Fill	Set the fill color in the table	
Line width	Set the width of table lines	

■ Security setting

The screenshot shows a 'Form' window with three tabs: 'Basic prop', 'Security se', and 'Position'. The 'Position' tab is active. It contains two main sections: 'Display control' and 'User rights'. In the 'Display control' section, there is a checked 'Enable' checkbox, a 'When' dropdown menu set to '隐藏', an 'Equip' dropdown menu set to '本地设备', an 'Adresse' dropdown menu set to 'PSB', and an 'Enable station' dropdown menu set to 'ON'. There are also two input boxes with '0' and a 'Set' button. In the 'User rights' section, there is a checked checkbox for 'Hide the component when the user has no permission range' and a 'Required user permission range' dropdown menu set to '权限1'.

Same to chapter 4-1-1. Straight line security setting.

■ Position

Same as chapter 4-1-1. Straight line position part.

4-1-7. Scale

1. Click "Mapping/Scale" in the menu bar or  icon in the control window's drawing bar, move the cursor to the screen, click the left mouse button to place, click the right mouse button or click ESC to cancel the placement. Modify the length and width of the border through the border points.
2. When setting attributes, you can set them in the attribute box that pops up when placing components. You can also double-click "Scale" or select "Scale", right-click and select Attribute.

■ Basic property

Scale

Basic prop Security st Position

Control ID: S0

Describe:

Style: Style 水平

Scale

Line style: Line width:

Line color:

Main engraving: 10 Main scale leng: 30

Sub engraving: 1 Sub scale leng: 15

Axis

Tick marks

Use

Integer bit: 3 Decimal p: 0

Upper lim: 100 Register

Lower lim: 0 Register

Typeface

Typ: 微软雅黑 常规

Col: Size: 12

Scale reverse sort

Location: 上

Determine Cancel Application

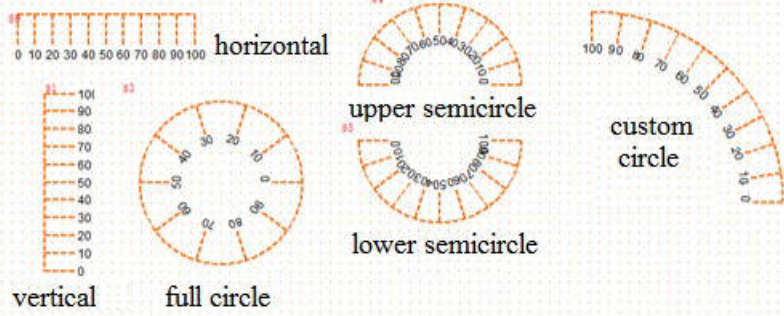
Control ID	It is used for system management control and cannot be operated by users
Describe	Can be used to comment on the purpose of this component
Style	Set the scale style, including horizontal, vertical, upper semicircle, lower semicircle, full circle, and custom circle
Scale	 <p>horizontal</p> <p>vertical</p> <p>full circle</p> <p>upper semicircle</p> <p>lower semicircle</p> <p>custom circle</p>
Line style	Set the line style of the scale, including solid line, long dotted line, short dotted line, and point line
Line width	Set the line width of the scale
Line color	Set the line color of the scale
Main scale	Set the main scale numbers
Main scale length	Set the main scale length

	Sub scale	Set the sub scale numbers
	Sub scale length	Set the sub scale length
	Axis	Set whether the axis is displayed
Scale marks		Select it to set the following items
Integer digits		Set the number of integer bits of the scale mark
Decimal digits		Set the number of decimal places of the scale mark
Upper limit		Set the upper limit of the scale value, that is, the maximum value
Register		Check "Register", and the upper limit value can be controlled by the register
Lower limit		Set the lower limit of the scale value, i.e. the minimum value
Register		Check "Register", and the lower limit value can be controlled by the register
Typeface		Set the scale font, font size, font style, color and alignment method
Scale Reverse Sort		When not checked, the semicircle scale is displayed counterclockwise, the horizontal scale is displayed from left to right, and the vertical scale is displayed from bottom to top; When checked, the semicircle scale is displayed clockwise, the horizontal scale is displayed from right to left, and the vertical scale is displayed from top to bottom
Location		Set the scale position as up, down or center

■ Security setting

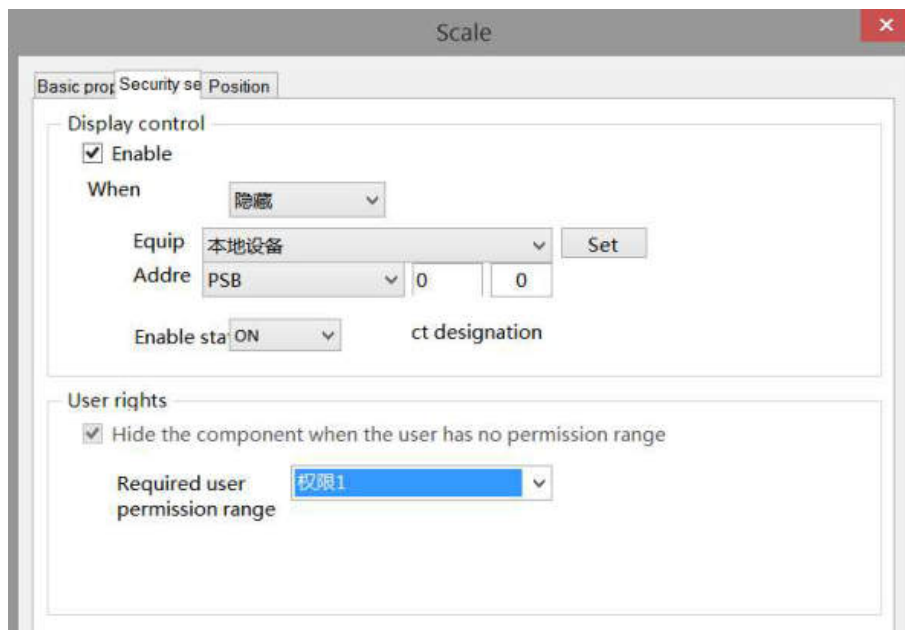

Same to chapter 4-1-1. Straight line security setting.

■ Position

Same as chapter 4-1-1. Straight line position part.

4-1-8. QR code







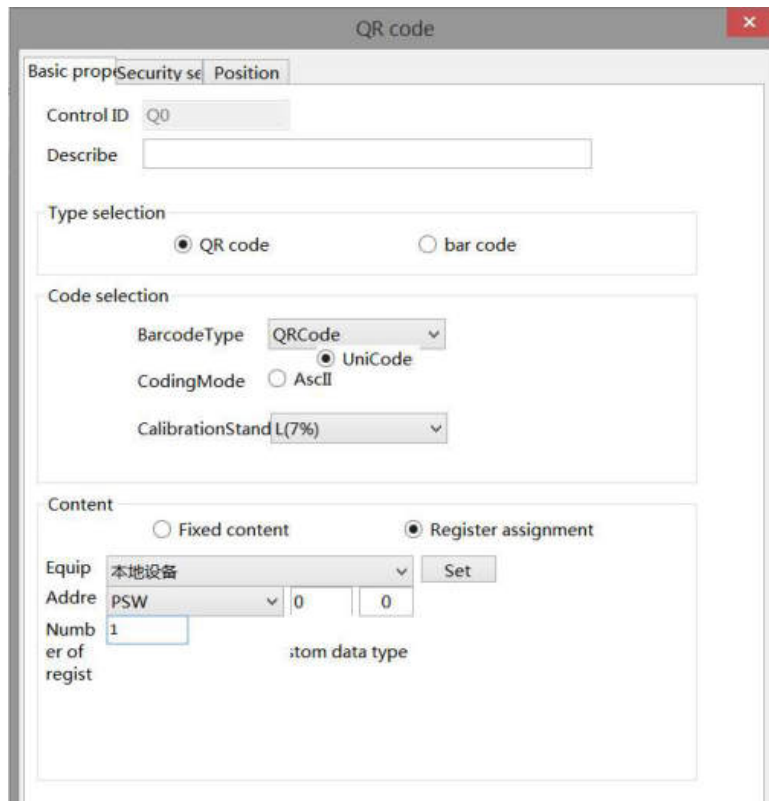

1. Click the "Mapping/QR Code" icon in the menu bar or the  icon in the drawing bar of the control window, move the cursor to the screen, click the left mouse button to place it, click the right mouse button or

click ESC to cancel the placement. Modify the length and width of the border through the border points.

2. When setting attributes, you can set them in the attribute box that pops up when placing components, or you can double-click QR Code or select QR Code and right-click to select Attribute.

■ Basic property

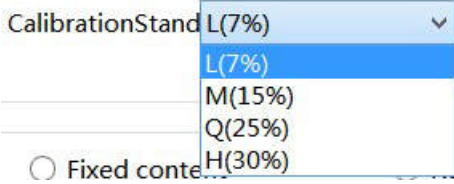

Control ID		It is used for system management control and cannot be operated by users						
Describe		Can be used to comment on the purpose of this component						
Type selection		You can select QR code or barcode						
Code selection	Barcode type	Set the type of barcode. The QR code includes QRCode, DataMatrix, PDF417						
		<table border="1"> <tr> <td>QRCode</td> <td>  <p>(It is mainly used in the Internet, logistics information tracing, retail billing applications, etc. For example, the QR code presented by mobile payment is the most commonly used QR code type)</p> </td> </tr> <tr> <td>DataMatrix</td> <td>  <p>(Mainly used in the industrial field to achieve quality traceability)</p> </td> </tr> <tr> <td>PDF417</td> <td>  <p>(It is mainly used for certificate management, report management, etc)</p> </td> </tr> </table>	QRCode	 <p>(It is mainly used in the Internet, logistics information tracing, retail billing applications, etc. For example, the QR code presented by mobile payment is the most commonly used QR code type)</p>	DataMatrix	 <p>(Mainly used in the industrial field to achieve quality traceability)</p>	PDF417	 <p>(It is mainly used for certificate management, report management, etc)</p>
		QRCode	 <p>(It is mainly used in the Internet, logistics information tracing, retail billing applications, etc. For example, the QR code presented by mobile payment is the most commonly used QR code type)</p>					
DataMatrix	 <p>(Mainly used in the industrial field to achieve quality traceability)</p>							
PDF417	 <p>(It is mainly used for certificate management, report management, etc)</p>							

	Bar code	 <p>(Mainly used for commodity barcode)</p>
	Coding mode	Set the encoding method of AscII or UniCode (this option is available only for QRCode types, and only has AscII for other types)
	Calibration standard	<p>Set calibration standard (only available under QRCode type)</p>  <p>Calibration standard of QR code: When you encode QR code, you also create some redundant data, which will help QR reader read QR code accurately. Even if part of it is unreadable data, it will not affect reading correct information.</p> <p>There are four levels of error correction in the QR code, the lowest is</p> <p>L: Calibrate 7% of the font size M: Calibrate 15% of the font size Q: Calibrate 25% of the font size H: Calibrate 30% of the font size</p>
Content	Fixed content	Display fixed content (click the blank part to set the content)
	Register assignment	Dynamically specifying QR Codes with registers
	Equipment	Select the current device port for communication
	Address	Set the QR code monitoring address and whether there is offset
	Number of register	Set the number of registers (you can enter the corresponding number of registers according to the content to be set. If you do not check the user-defined data type, the default is WORD-16 bits)
	Custom data type	After checking, you can set the data type. DWORD-32 bits, DDWORD-64 bits



Note: If the QR code content is specified by a register, the register should be a character input register, and data input registers are not supported.

■ Security setting

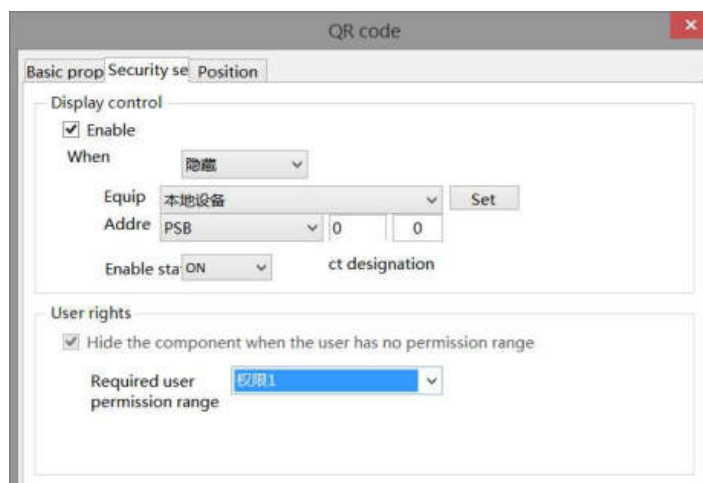

Same to chapter 4-1-1. Straight line security setting.

- Position

Same as chapter 4-1-1. Straight line position part.

4-1-9. Picture

1. Click the "Mapping/Picture" icon in the menu bar or the  in the control window, move the cursor to the screen, click the left mouse button to place it, click the right mouse button or click ESC to cancel the placement. Its size can be adjusted by dragging the mouse.

2. When setting attributes, you can set them in the attribute box that pops up when placing components, or you can double-click "GIF picture" or select "GIF picture", right-click and select "Attribute".

- Basic property

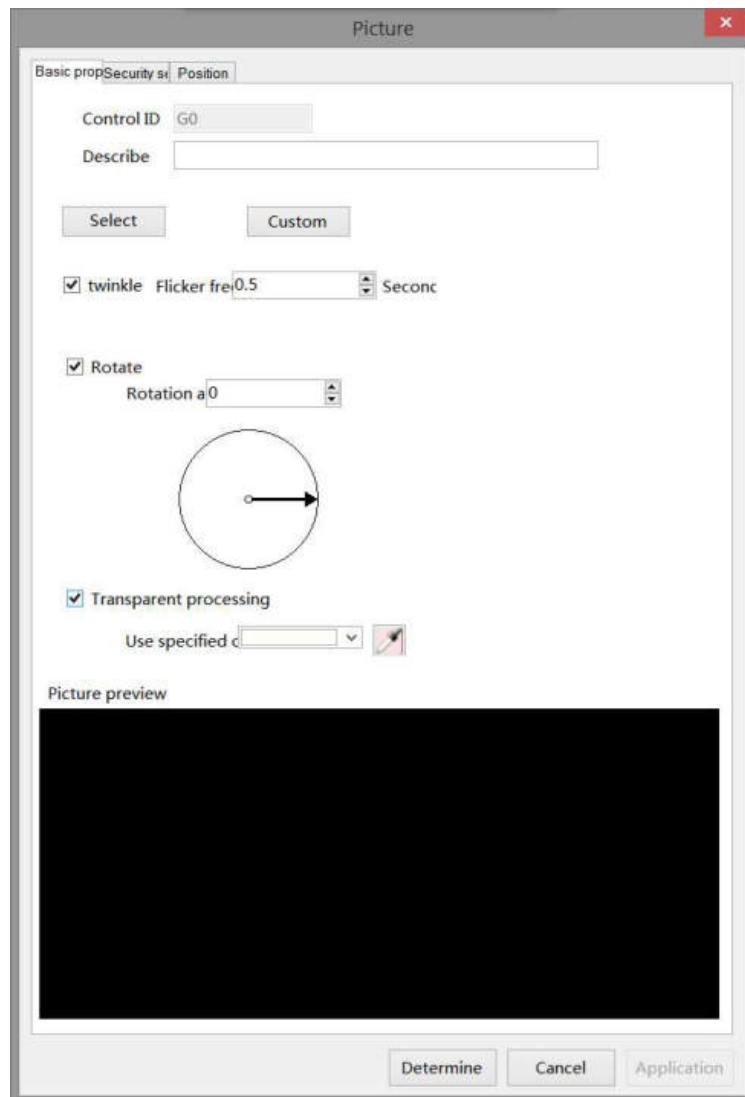

Control ID	It is used for system management control and cannot be operated by users
Describe	Can be used to comment on the purpose of this component
Select	Click to insert the picture in the resource library
Custom	Click to add pictures on your computer

Twinkle	Set whether the picture flickers and flicker frequency (unit: second)
Rotate	Set whether the picture is rotated and the rotation angle
Transparent processing	Set the specified color to make the picture transparent (only one color of the selected picture can be transparent)
Picture preview	You can preview the selected picture



The color picker can select any color in the screen for color picking

Examples of transparent processing:

As shown in the figure below, prepare to remove the black background outside the lamb



- (1) Select gif from the control window to put on the screen
- (2) Select the image to be processed from the customized path, click Transparent Processing, use the color picker to select the dark blue of the lamb background for color extraction, or select the same color as the lamb background after using the specified color

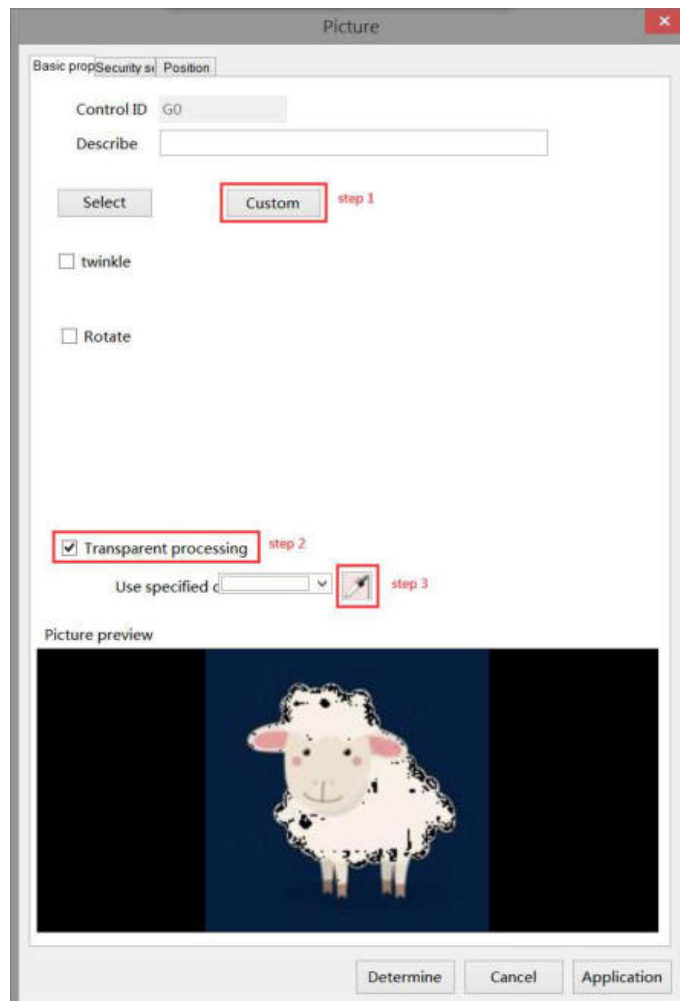

(3) After color selection, the page is displayed as shown below

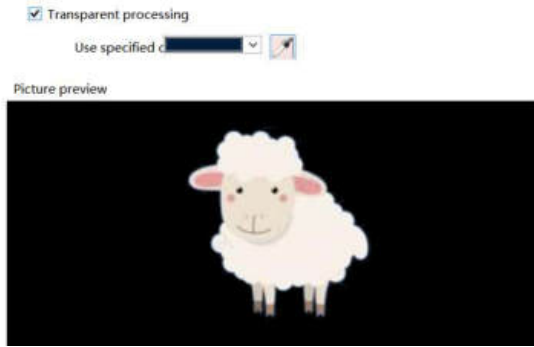

(4) Click OK to display as shown below



Transparent processing

before

after

■ Security setting

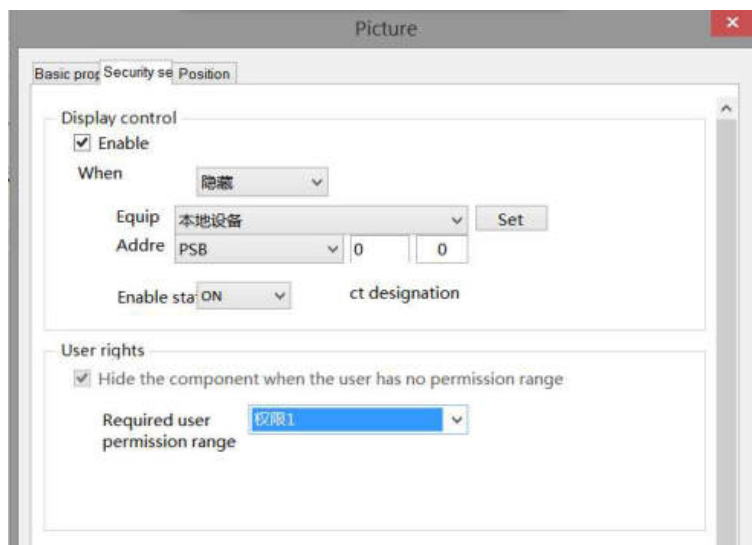

Same to chapter 4-1-1. Straight line security setting.

■ Position

Same as chapter 4-1-1. Straight line position part.

4-1-10. Dynamic picture

1. Click "Mapping/Dynamic Picture" on the menu bar or click the  icon in the drawing bar of the control window, move the cursor to the screen, click the left mouse button to place it, click the right mouse button or click ESC to cancel the placement. Set multiple pictures. The pictures can be switched freely according to fixed time and order. The size can be adjusted by dragging the mouse.

2. When setting attributes, you can set them in the attribute box that pops up when placing components. You can also double-click "Dynamic Picture" or select "Dynamic Picture", right-click and select "Attribute".

■ Animation materials

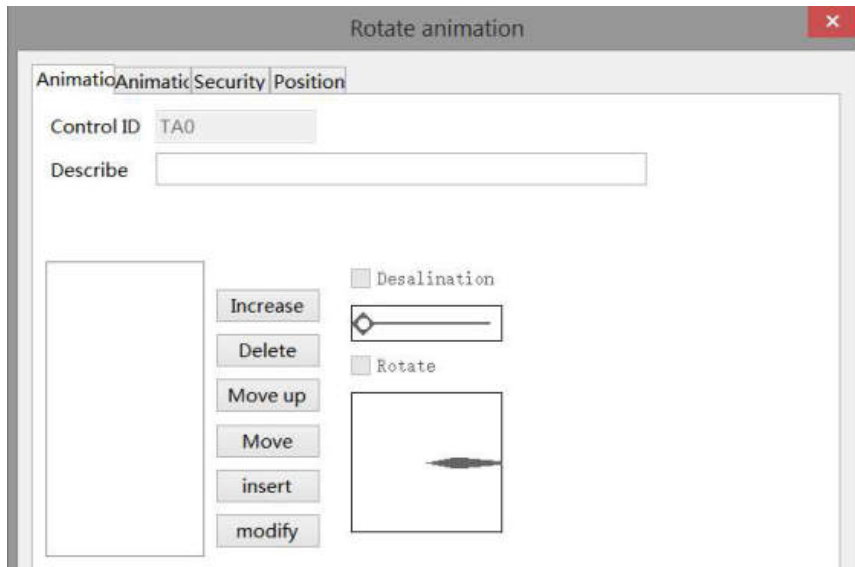

Control ID		It is used for system management control and cannot be operated by users
Describe		Can be used to comment on the purpose of this component
Function	Increase	Pictures in the material library or user-defined pictures can be added (the picture size should be less than 1920 * 1080)
	Delete	Delete the specified pictures added to the material
	Move up	Move the specified picture up
	Move down	Move the specified picture down
	Insert	Insert picture in this position
	Modify	Modify the selected picture
Fade-out		<p>After checking, you can set whether the picture needs to be faded by sliding the slider (the closer the slider is to the left, the higher the degree of fading)</p>
Rotate		<p>After checking, the picture can be rotated at will to achieve the target effect (when the pointer is dragged to rotate clockwise/counterclockwise, the picture will also rotate clockwise/counterclockwise)</p>

■ Animation

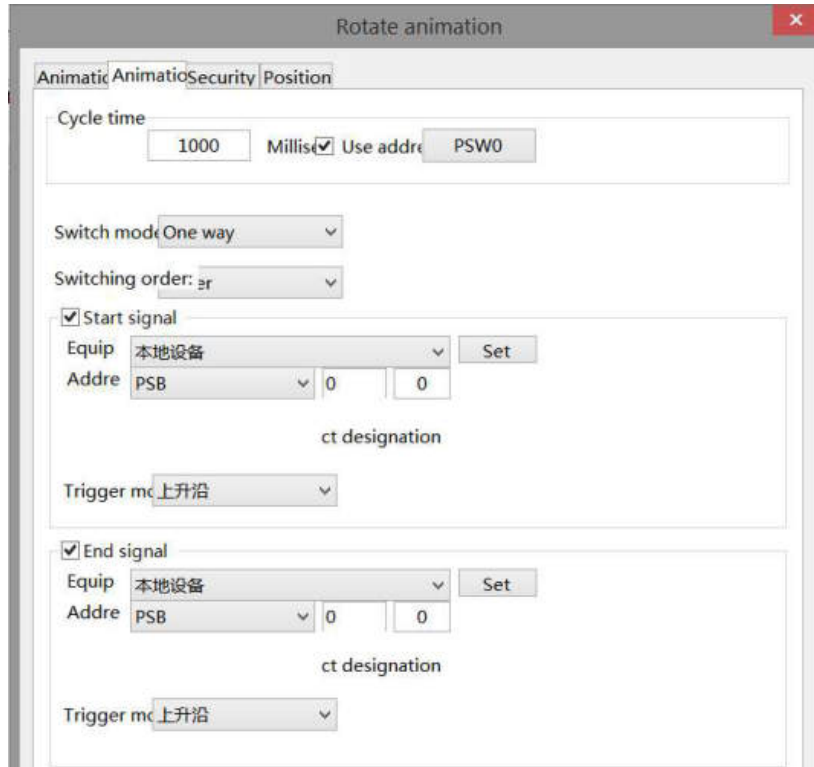

Cycle time		Set the time of a cycle (that is, all pictures are switched). You can set a constant or specify it through a register
Switch mode	One way	Pictures are displayed from the first to the last, and then from the first to the last.....
	Return	Pictures are displayed in the mode of first to last, then last to first, and then first to last.....
Switching order		Set the switching order of the picture, which is specified by the picture number (1-10, 10-1, or randomly set by the user)
Order		Pictures are displayed in order
Reverse order		Pictures are displayed in reverse order
Random		Pictures are displayed randomly without fixed order, and they are displayed in the order set by the user, separated by English commas ","
Start signal		If checked, the animation starts when the specified coil is ON or OFF; If not checked, the animation will always act
Equipment		Select the current device port for communication
Set		Click "Set" to enter the address setting interface, where you can set and use system registers and user-defined tags. You can click the address tag library below or the project tree - library - address tag library to set the used tags (see chapter 5-2 Address Tag Library for the use of address tag library and user-defined tags)

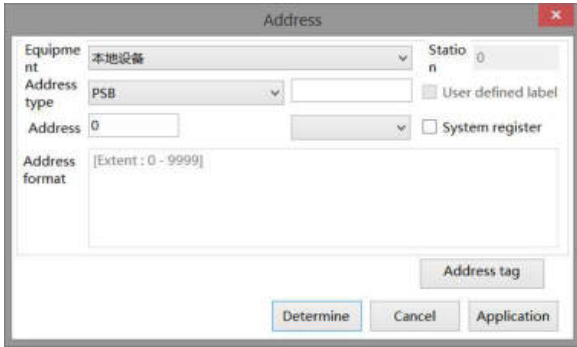
	
Address	Set the object address of the control start signal and whether it is offset (that is, specified indirectly)
Indirect assignment	Set the current address offset. The current register address changes with the indirectly specified register value, that is, $Dx [Dy]=D [x+Dy \text{ value}]$ ($x, y=0, 1, 2, 3\dots$). For example, the current coil address is PSB0, if the indirectly assigned address is PSW100. When the value of PSW100 register is 0, the coil controlling this element is still PSB0; When the value of PSW100 register is 1, the coil controlling this element is PSB1 (and so on)
Start signal trigger mode	The trigger of rising/falling edge can be customized
End signal	If checked, the animation ends when the specified coil is ON or OFF
End signal trigger mode	The trigger of rising/falling edge can be customized

■ Security setting

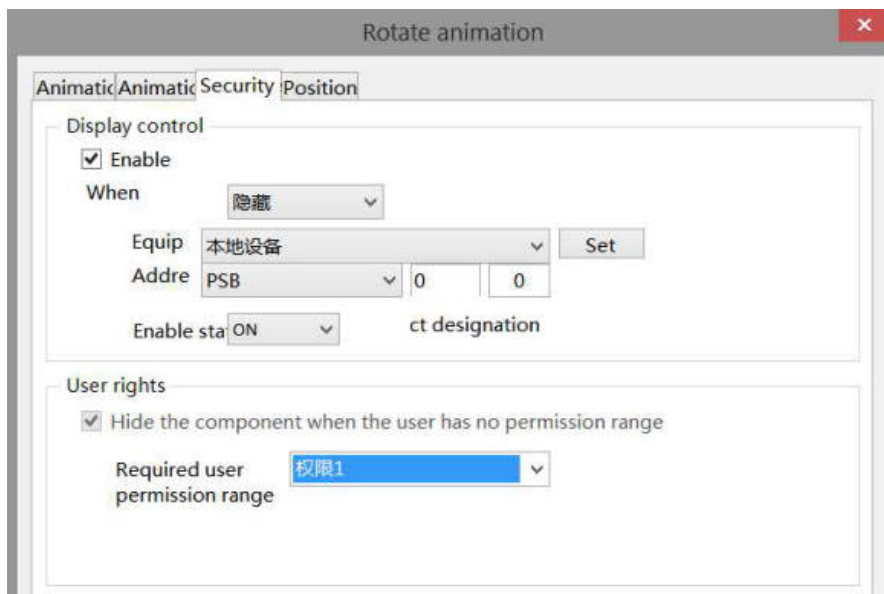

Same to chapter 4-1-1. Straight line security setting.

■ Position

Same as chapter 4-1-1. Straight line position part.

4-1-11. Translating animation

The use of translation animation components can help users achieve animation functions, but a single translation animation component cannot achieve animation functions. It must be combined with the components that achieve animation functions.

1. Click "Mapping/Translating Animation" on the menu bar or click the  icon in the drawing bar of the control window, move the cursor to the screen, press the left mouse button at the starting point, drag the cursor to move, and determine the positions of the following endpoints in turn. Double click the left mouse button (click the right mouse button or click ESC to cancel the placement) to finish the drawing of the translating animation, and the property box will pop up at the same time.
2. When setting attributes, you can set them in the attribute box that pops up when placing components. You can also double-click "Translation Animation" or select "Translation Animation" and then right-click to select "Attributes".

■ Coordinate

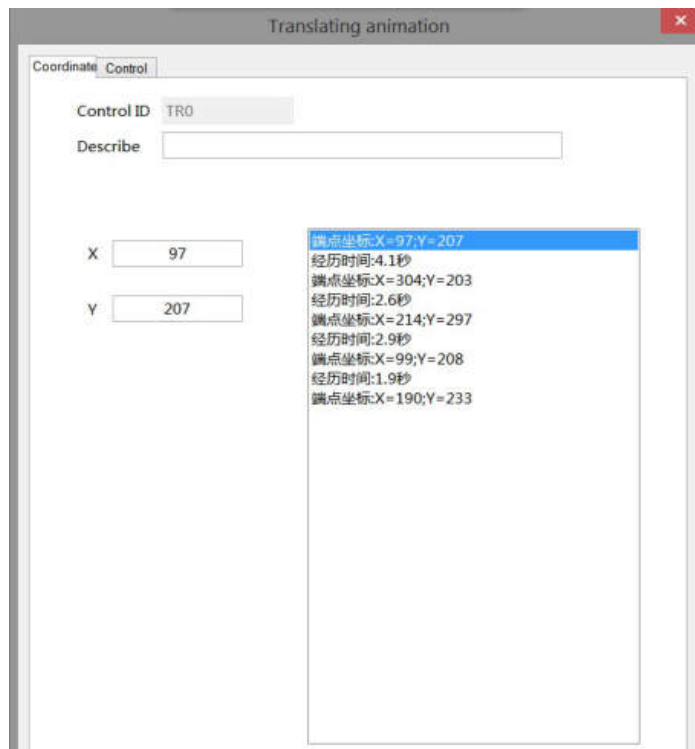

Control ID	It is used for system management control and cannot be operated by users	
Describe	Can be used to comment on the purpose of this component	
Endpoint coordinates	X	Display the horizontal coordinate position of the current end point. After selecting the line "End point coordinate" on the right, you can modify it at the left "X"
	Y	Display the longitudinal coordinate position of the current end point. Select the line "End point coordinate" on the right and modify it at the left "Y"
Experience time	Display the time of moving from the current endpoint coordinate to the next endpoint coordinate, in seconds. After selecting the "experience time" line on the right, you can modify it at the "Time" position on the left	

■ Control

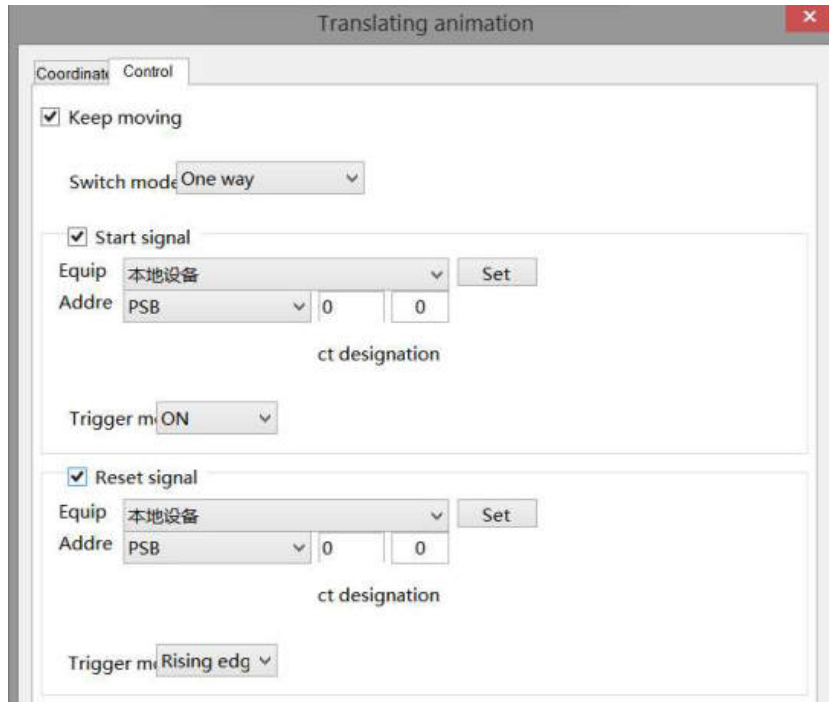

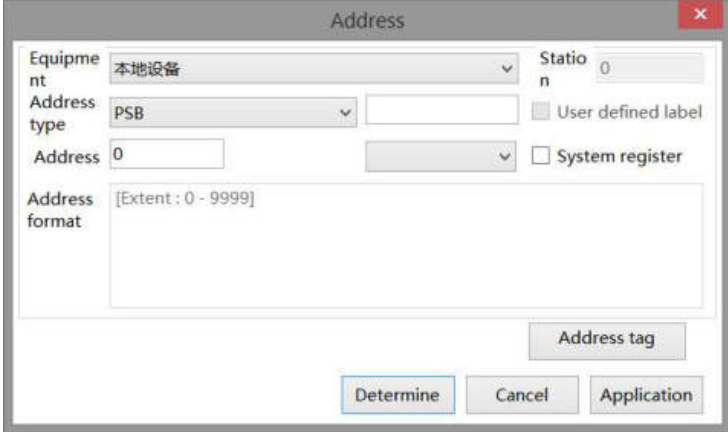
Keeping moving	Select whether the animation repeats the action according to the specified track; After checking, the animation will repeat the motion according to the set track. If it is not checked, the action will be performed once
Switch mode	One way mode: act from the starting point to the ending point according to the drawn path; Return mode: move back and forth from the starting point to the end point and from the end point to the starting point according to the drawn path
Start signal	Select whether the action trigger is controlled by the bit signal. When selected, the animation starts when the rising edge of the bit signal comes and remains in the ON state (when the falling edge of the bit signal comes and remains in the OFF state)
Equipment	Select the current device port for communication
Set	<p>Click "Set" to enter the address setting interface, where you can set and use system registers and user-defined tags. You can click the address tag library below or the project tree - library - address tag library to set the used tags (see chapter 5-2 Address Tag Library for the use of address tag library and user-defined tags)</p> 
Address	Set the object address of the control start signal and whether it is offset (that is, specified indirectly)

Indirect assignment	Set the current address offset. The current register address changes with the indirectly specified register value, that is, $Dx [Dy]=D [x+Dy \text{ value}]$ ($x, y=0, 1, 2, 3\dots$). For example, the current coil address is PSB0, if the indirectly assigned address is PSW100; When the value of PSW100 register is 0, the coil controlling this element is still PSB0; When the value of PSW100 register is 1, the coil controlling this element is PSB1 (and so on)
Start signal trigger mode	Customizable ON/OFF trigger
Reset signal	Select whether the end of the action is controlled by a bit signal. After selecting, when the rising/falling edge of the bit signal comes, the animation will start from the beginning
Reset signal trigger mode	The trigger of rising/falling edge can be customized

Example:

To realize the text string "Xinje Electric welcomes you!" Scroll the display from top to bottom on the screen. You can draw a vertical translation animation track on the screen, place a static text string, select a static text string and a translation animation component, click the right mouse button, and select "Combination" to facilitate the movement of the text string according to the translation animation track. The movement time and control can be set by selecting "attribute":

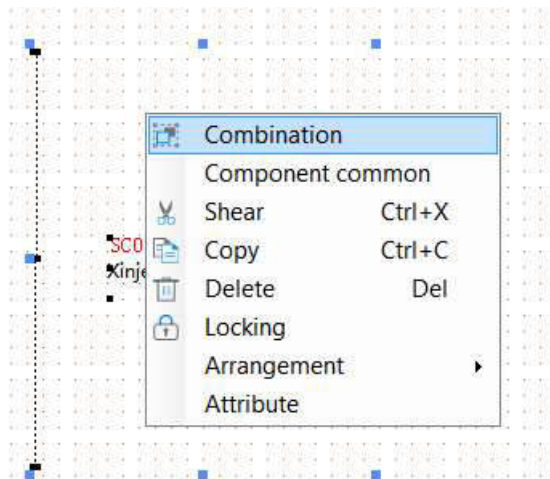

4-1-12. Function canvas

Through C function `DCMapDrawLine`, `DCMapDrawRect`, `DCMapDrawIrce`, `DCMapDrawEllipse`, `DCMapDrawCircleArc`, `DCMapDrawEiilipseArc`, the function of drawing lines, rectangles, circles, ellipses, arcs and elliptical arcs on the function canvas is realized. Clear the function canvas through `DCMapClear`. The function canvas background color filling function is realized through `DCMapSetBackColor`. Refer to 6-2-5 API Functions for the use of function canvas related functions.

■ Operate process

1. New project, screen content making

(1) Click the "Mapping/Function Canvas" on the menu bar or the  icon on the control window's drawing bar, move the cursor to the screen, click the left mouse button to place it, click the right mouse button or click ESC to cancel it. Modify the length and width of the border through the border points.

The establishment is shown in the following figure:

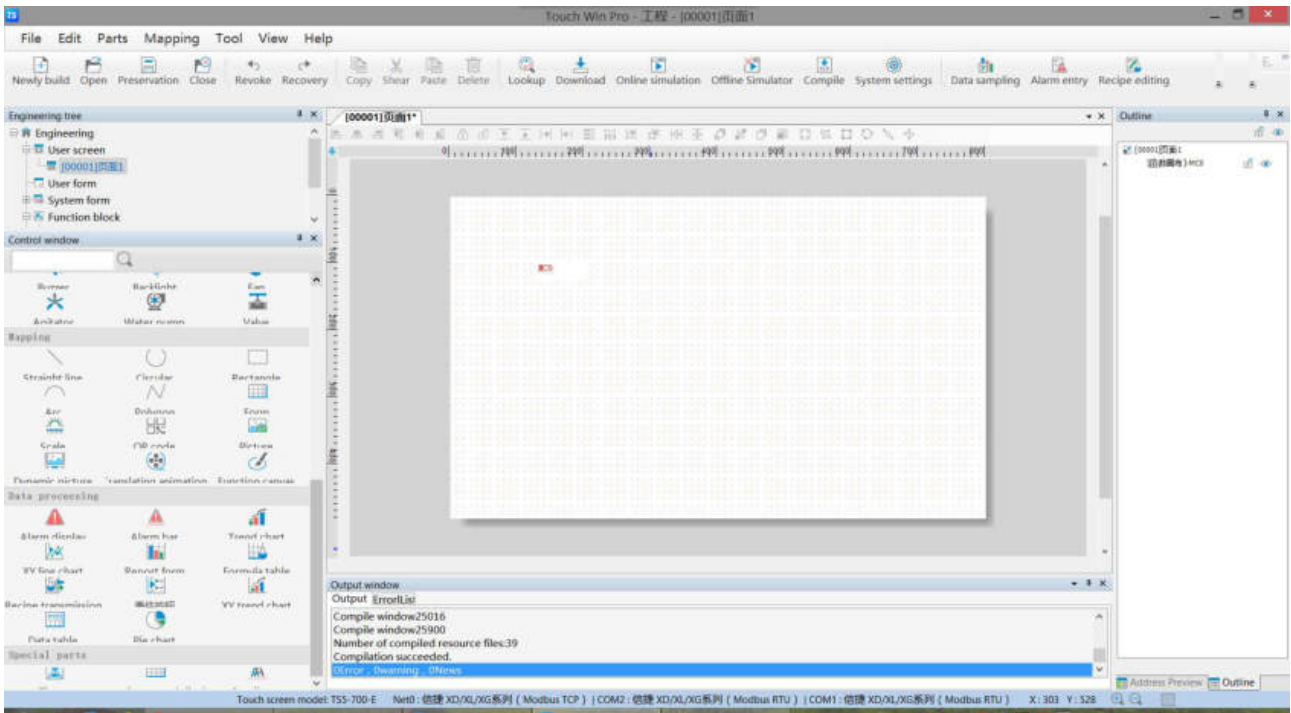

(2) When setting attributes, you can set them in the attribute box that pops up when placing components. You can also double-click the Function Canvas or select the Function Canvas, right-click, and select attribute.

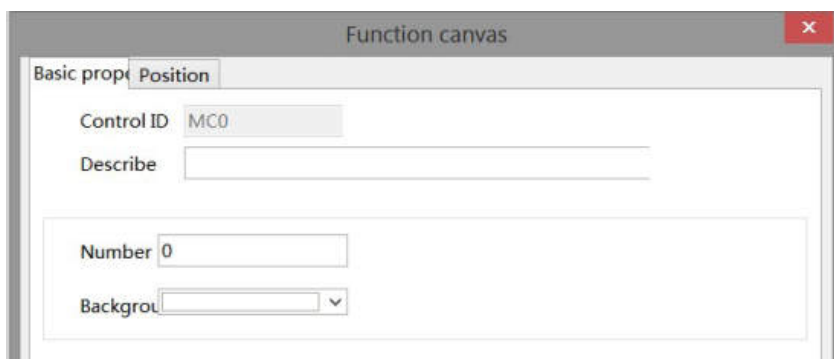

Control ID	It is used for system management control and cannot be operated by users
Describe	Can be used to comment on the purpose of this component
Number	Set MacroDCMap function number
Background	Set Background color properties

2. Add Function Block

(1) To create a function block, right-click the project tree - Function Block. In the pop-up dialog box, select "Add Function" to add 2 functions. Set the function name (i.e. the function block name, which can be 32 characters at most) to DrawMap and DrawMapClear:

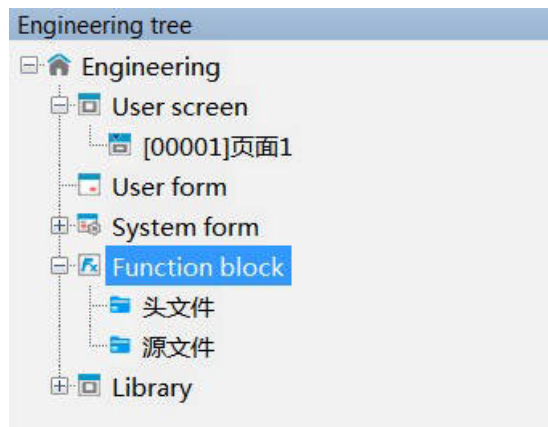

(2) Edit the function DrawMap, DrawMapClear. Open the function editing interface. The functions are as follows:

DrawMap:

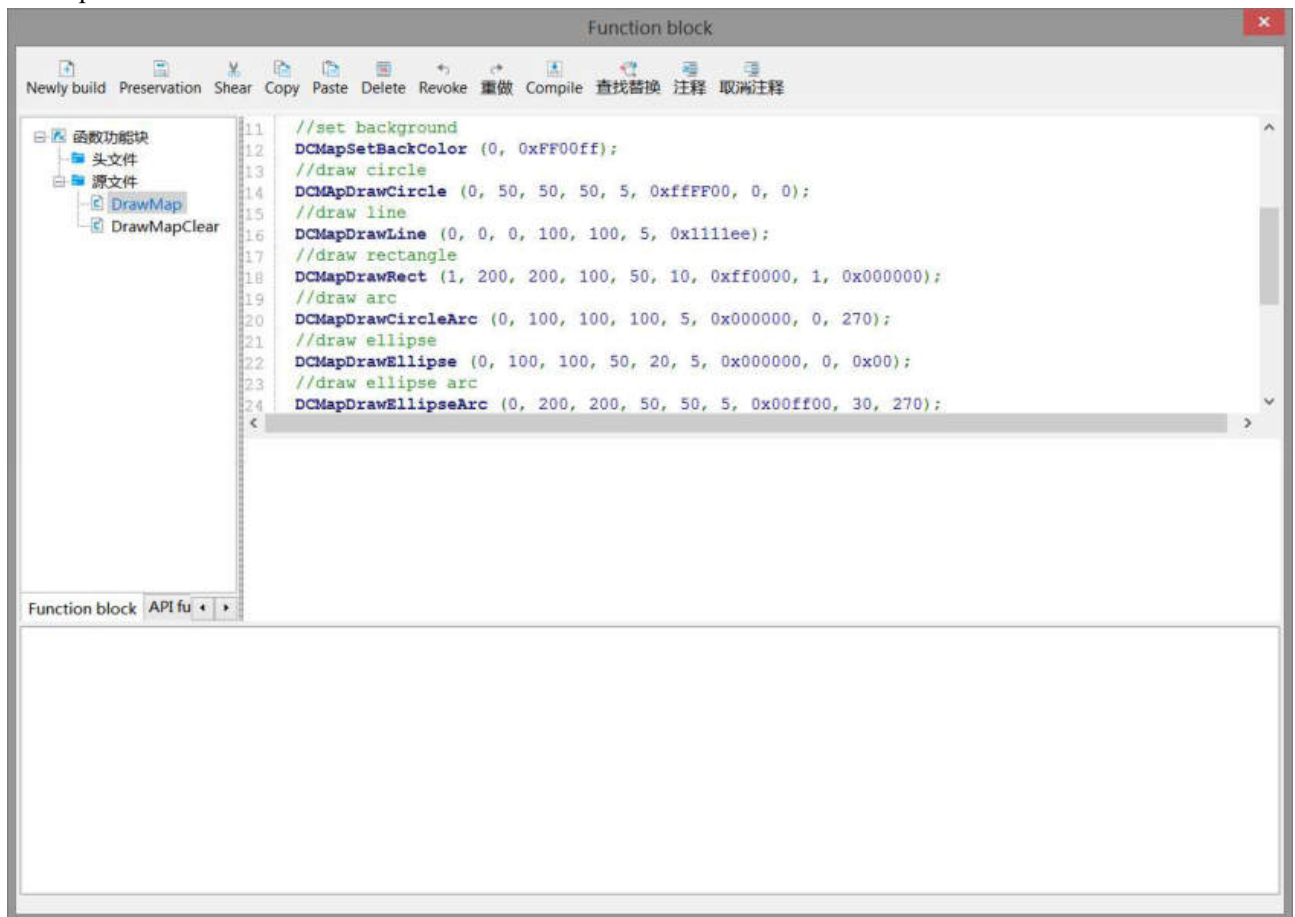

The TS series HMI uses RGB mode. One color occupies one byte, namely, 0xFF0000 is B (BLUE), 0x00FF00 is G (Green), and 0x0000FF is R (RED).

DrawMapClear:

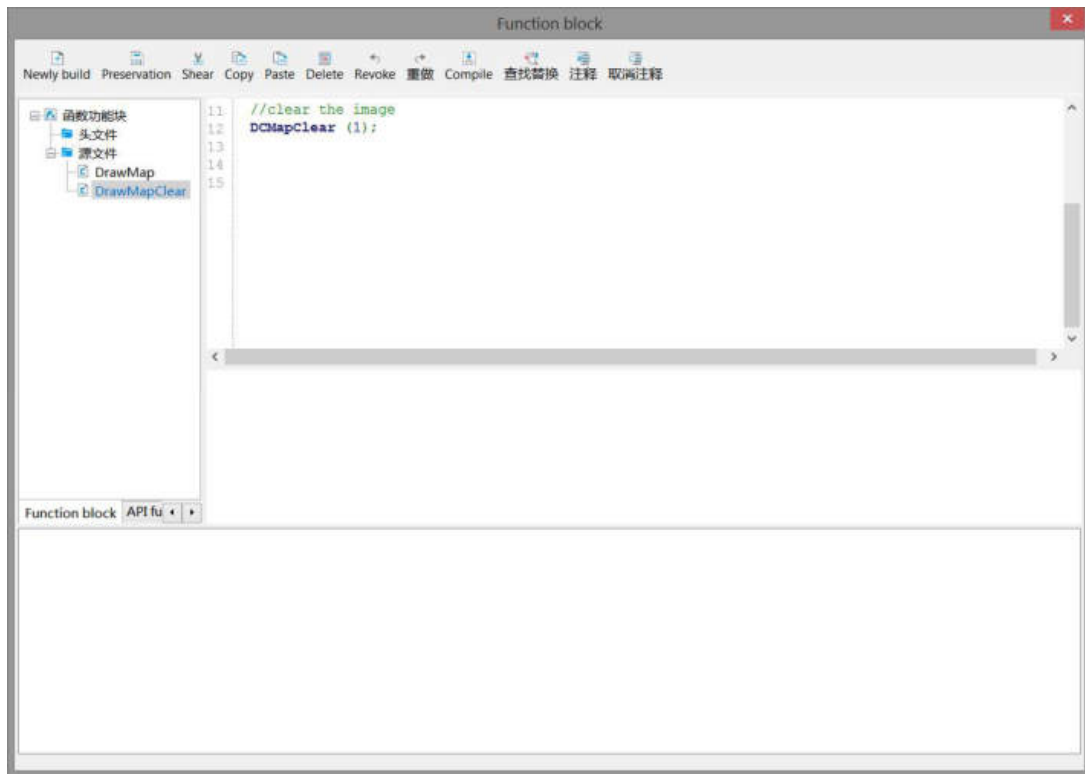

3. Call DrawMap, DrawMapClear

Place a function key on the screen, select "Function Call" from the "Optional Features" on the right, click "Add to" button to add this function, select the "Call Function" on the left, and select the name of the function to be called to add the function.

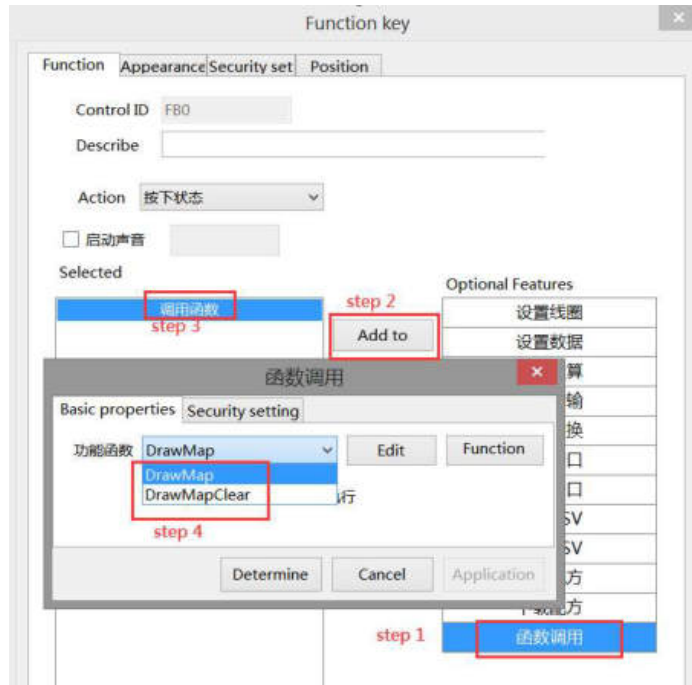

Click "Appearance" to set function key text, and finally click "OK" to finish setting.

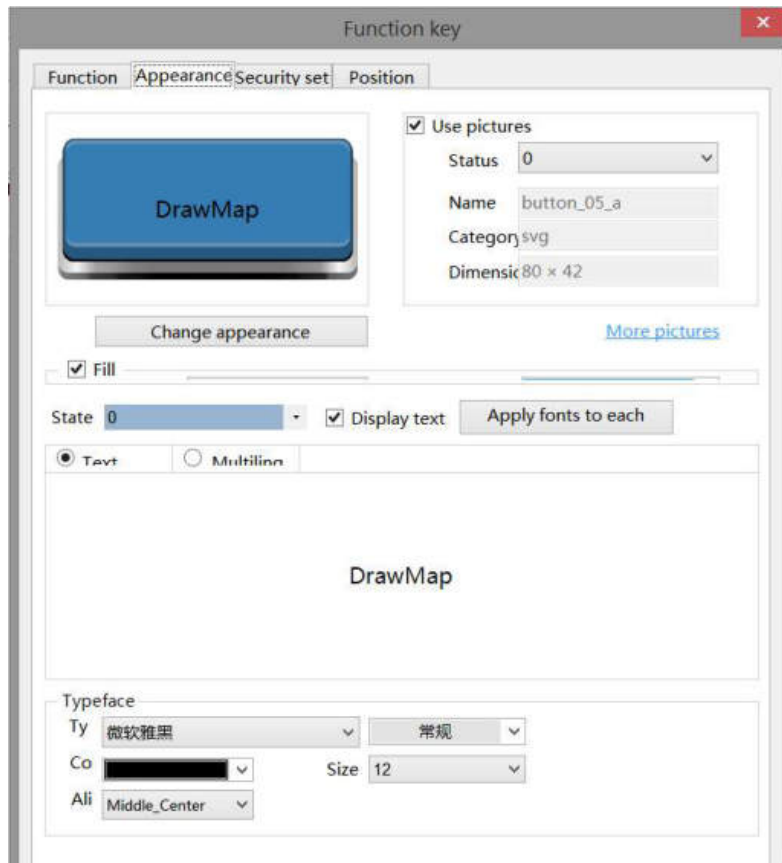

DrawMapClear function key is operated as above.

4. Download the program to the human-computer interface for operation.

■ Position

Same as chapter 4-1-1. Straight line position part.

4-2. Parts

The basic components include: static text, dynamic text, value input, value display, character input, character display, Chinese input, Chinese display, indicator light, indicator button, multi status indicator light, character key, key, multi status key, function key, function domain, sliding input and drop-down menu.



4-2-1. Static text

Set the text to be displayed.

1. Click the "Part/Text/Static Text" icon in the menu bar or the icon in the basic part bar of the control window, move the cursor to the screen, click the left mouse button to place it, click the right mouse button or click ESC to cancel the placement. Modify the length and width of the border through the border points.
2. When setting attributes, you can set them in the attribute box that pops up when placing components. You can also double-click Static Text or select Static Text and right-click to select Attribute.

- Basic property

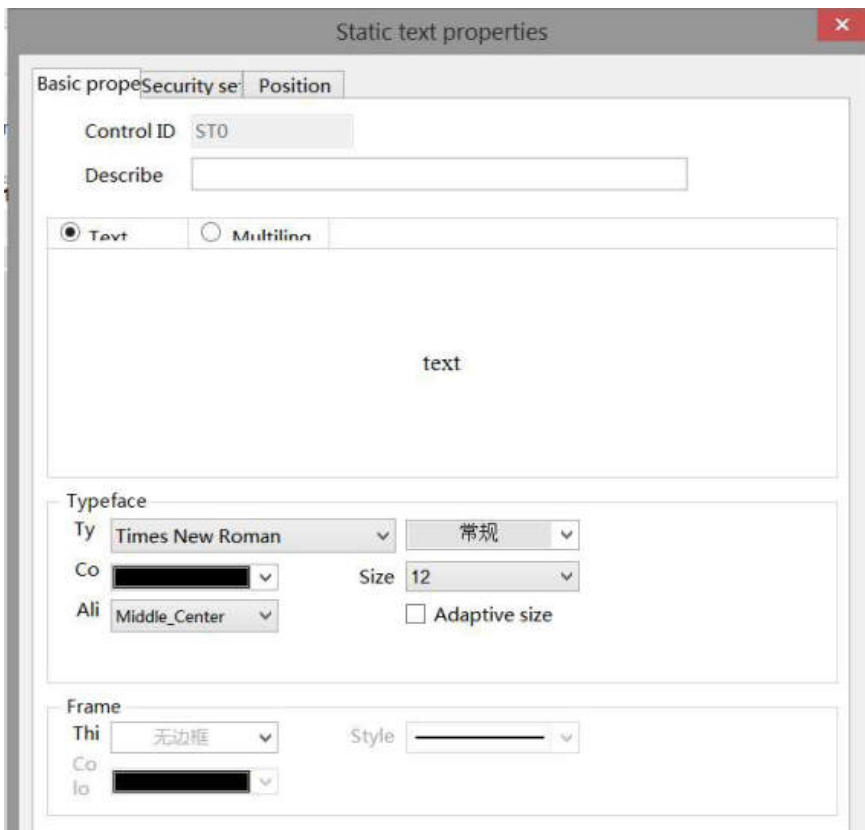

Control ID	It is used for system management control and cannot be operated by users
Describe	Can be used to comment on the purpose of this component
Text	Set the text to be displayed. Click/double click the text to modify it
Multilanguage library	Set up multilingual display. After selecting, you can click the "Add" text on the right side or the project tree - library – label multilingual on the left side of the project interface to manage multilingual (see chapter 4-7 for the library description for specific use)
Typeface	Set the text font, size, color and alignment (the position displayed in the box); You can check the adaptive size, that is, drag the mouse to change the size of the part, and the text size will change accordingly
Frame	Set the thickness, style and color of the border



Multi language library setting: if the current project has not edited labels in multiple languages, the text in the upper right corner is displayed as "New" (as shown in the left figure below). If the label has been edited in multiple languages, the text will be displayed as "Edit" (as shown in the right figure below).

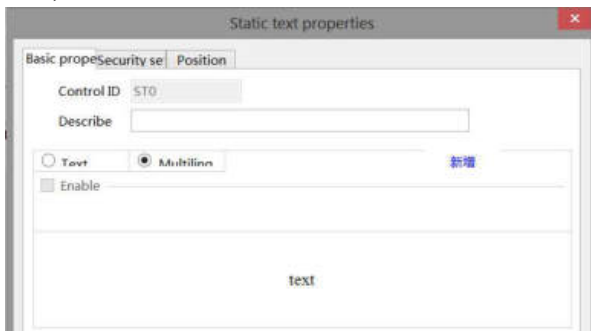

■ Security setting

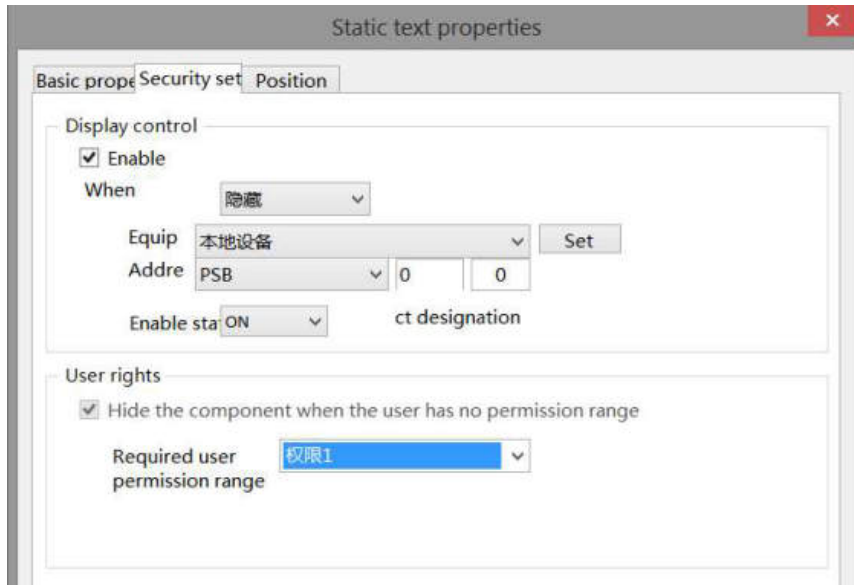

Same to chapter 4-1-1. Straight line security setting.

■ Position

Same as chapter 4-1-1. Straight line position part.

4-2-2. Dynamic text

Different characters can be displayed according to different register values.

1. Click "Part/Text/Dynamic Text" in the menu bar or  icon in the basic part bar of the control window, move the cursor to the screen, click the left mouse button to place it, click the right mouse button or click ESC to cancel it. Modify the length and width of the border through the border points.
2. When setting attributes, you can set them in the attribute box that pops up when placing components. You can also double-click "Dynamic Text" or select "Dynamic Text" and right-click to select "Attribute".

■ Basic property

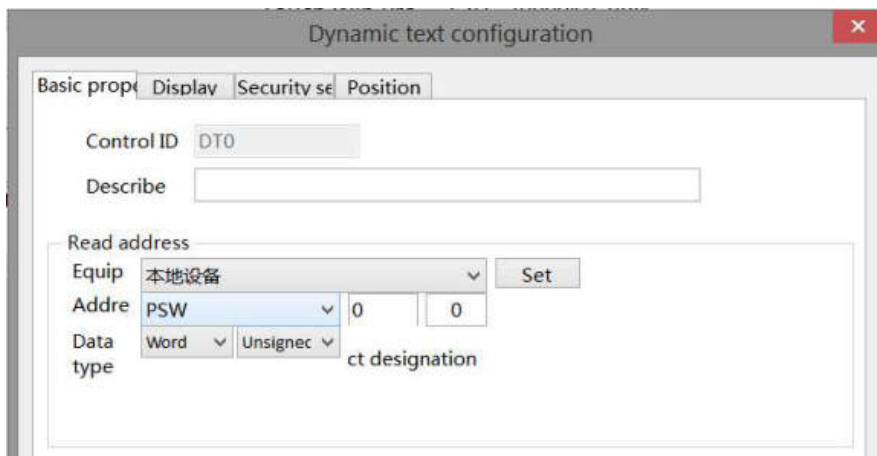

Control ID	It is used for system management control and cannot be operated by users
Describe	Can be used to comment on the purpose of this component

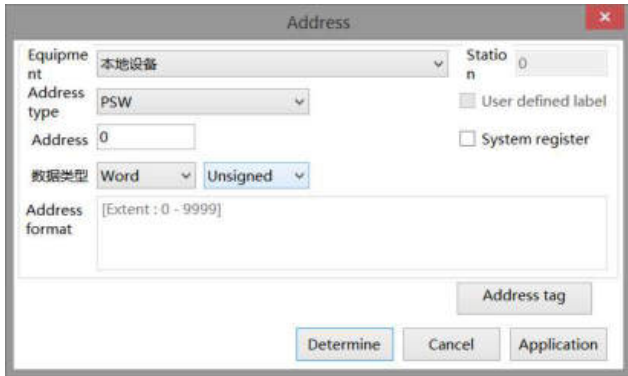
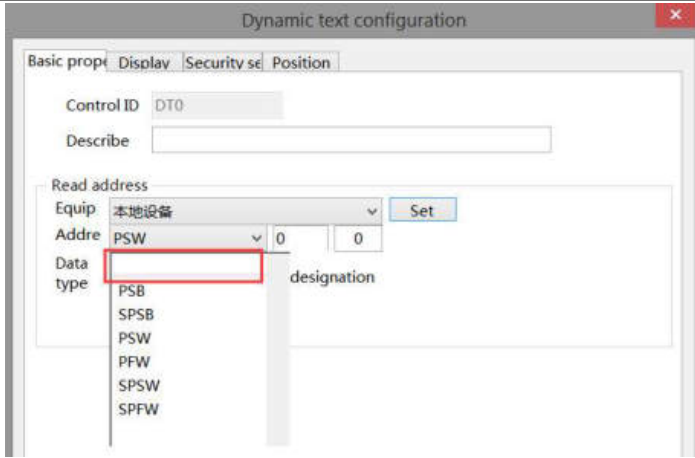
Read address	Set dynamic text object address
Equipment	Set the device port for communication
Address	Set target register number
Data type	Byte-8Bit, Word-16Bit, DWord- 32Bit, DDWord -64Bit, BCD, Hex, Signed, Unsigned, Floating number
Set	<p>Click "Set" to enter the address setting interface, where you can set and use system registers and user-defined tags. You can click the address tag library below or the project tree library address tag library to set the tags used (see chapter 5-2 Address Tag Library for the use of address tag library and user-defined tags)</p> 
Indirect assignment	Set the current address offset. The current register address changes with the indirectly specified register value, that is, $Dx [Dy]=D [x+Dy \text{ value}]$ ($x, y=0, 1, 2, 3\dots$). For example: the current register address is PSW0, if the indirectly specified address is PSW100; When the value of PSW100 register is 0, the register controlling this element is still PSW0; When the value of PSW100 register is 1, the register controlling this element is PSW1 (and so on)
Inquiry	 <p>Searchable address (the address bar of registers involved in the software will have input query, which will not be repeated later)</p>

■ Display

The display content of the register is determined by the value of the object register, and different characters can be displayed according to the value of the object register.

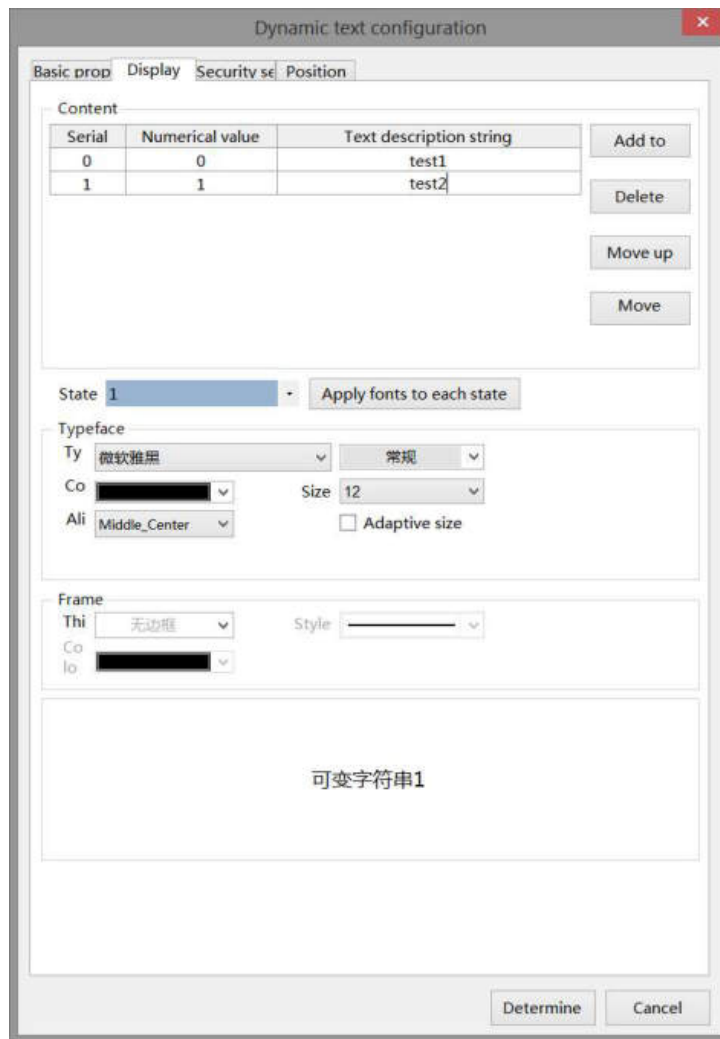

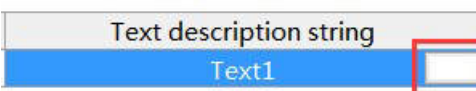
Content		<p>Set the text to be displayed in each state, click the contents under "Serial Number", "Numeric Value" and "Text Description String" to modify it (you can select the contents under "Click/Double click" text description string from the text library, and click the "..."</p>  <p>. You can enter the multilingual settings, or the project tree - Library - Label Multilanguage - on the left side of the project bar for management (see chapter 5-1 Label Multilanguage for specific use)</p>
Item	Add	Increase the number of dynamic text items
	delete	Delete the contents of the target option
	Move up	Move the target option up one physical location
	Move down	Move the target option down one physical location
State		You can check the drop-down list to set the font and border corresponding to the corresponding register value (or click the "apply fonts to each state" button behind to set the font and border in all states)
Typeface		Set the text font, size, color and alignment (the position displayed in the box). You can check the adaptive size, that is, drag the mouse to change the size of the part, and the text size will change accordingly
Frame		Set the thickness, style and color of the border

.....

Example: The setting is as shown in the figure above. When the value of PSW0 is 0, the dynamic string displays the variable string 0.

When the value of PSW0 is 1, the dynamic string displays variable string 1 and so on.

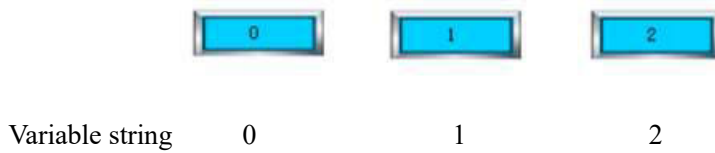

Maximum number of dynamic text strings:

When the data type is Word Usigned, the value range is 0~65535. Because the values of dynamic text strings cannot be repeated, the maximum number of dynamic text strings of this data type is 65536. The same applies to other data types.

■ Security setting

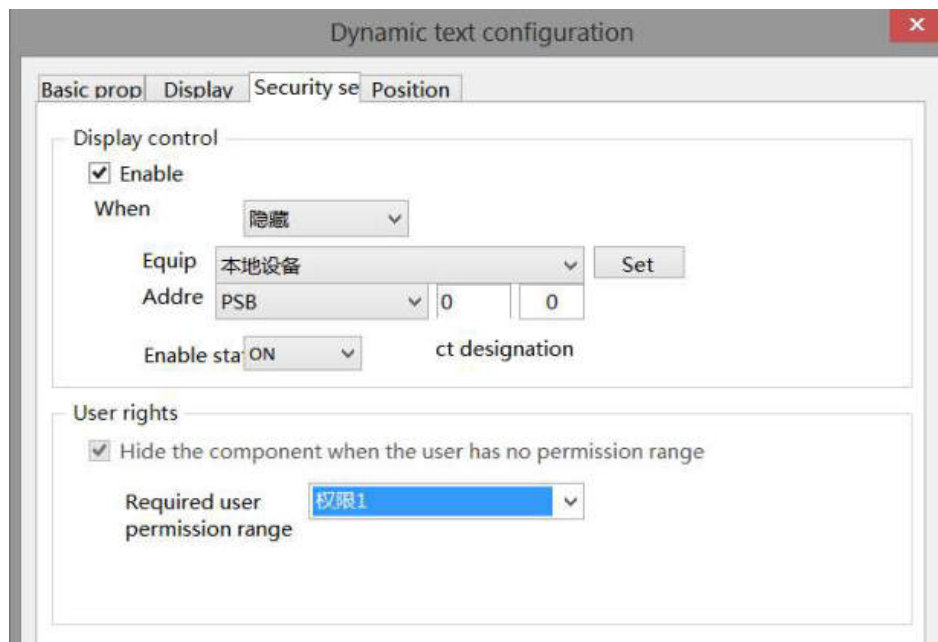

Same to chapter 4-1-1. Straight line security setting.

■ Position

Same as chapter 4-1-1. Straight line position part.

4-2-3. Numeric input

1. Click the "Part/Input/Numerical Input" in the menu bar or the  icon in the basic part bar of the control window, move the cursor to the screen, click the left mouse button to place it, click the right mouse button or click ESC to cancel it. Modify the length and width of the border through the border points.

2. When setting attributes, you can set them in the attribute box that pops up when placing components. You can also double-click Numeric Input or select Numeric Input and right-click to set attributes.

■ Basic property

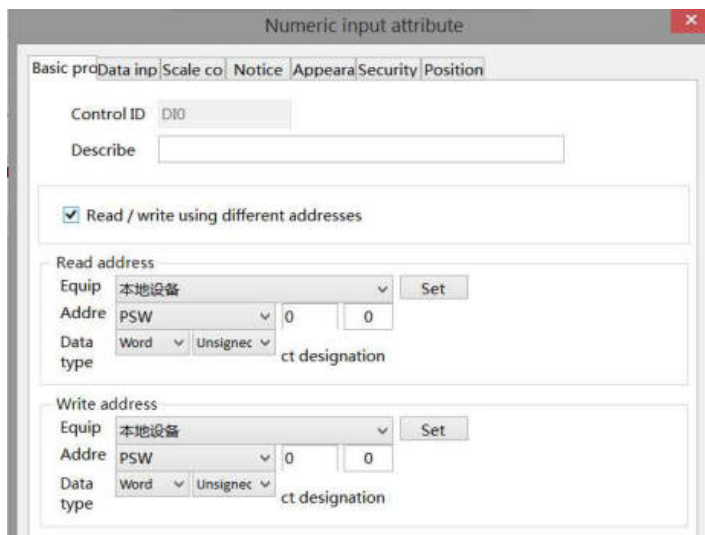

Control ID	It is used for system management control and cannot be operated by users
Describe	Can be used to comment on the purpose of this component
Read/write using different addresses	If not checked, the same address is used for reading and writing
Read address	Set the displayed address. You can also set whether there is an offset (that is, indirect assignment)
Write address	Set the write address. You can also set whether there is an offset (that is, indirect assignment)
Equipment	Current equipment port for communication
Address	Set target register number
Data type	Byte-8Bit, Word-16Bit, DWord- 32Bit, DDWord -64Bit, BCD, Hex, Signed, Unigned, Floating number
Set	Click "Set" to enter the address setting interface, where you can set and use system registers and user-defined tags. You can click the address tag library below or the project tree – library - address tag library to set the tags (see chapter 5-2 Address Tag Library for the use of address tag library and user-defined tags)
Indirect assignment	Set the current address offset. The current register address changes with the indirectly specified register value, that is, $Dx [Dy]=D [x+Dy \text{ value}]$ ($x, y=0, 1, 2, 3\dots$). For example: the current register address is PSW0, if the indirectly specified address is PSW100; When the value of PSW100 register is 0, the register controlling this element is still PSW0; When the value of PSW100 register is 1, the register controlling this element is PSW1 (and so on)

Example:

(1) Read/input using the same address (that is, do not check read/write using different addresses)

Read / write using different addresses

Read / write address

Equip	本地设备	Set
Addr	PSW	0 0
Data type	Word Unsignec	ct designation

Input 1 to PSW0, and PSW0 displays 1; The number entered is the number displayed.



(2) Read/input using different addresses (that is, check read/write using different addresses)

Read / write using different addresses

Read address

Equip	本地设备	Set
Addr	PSW	0 0
Data type	Word Unsignec	ct designation

Write address

Equip	本地设备	Set
Addr	PSW	1 0
Data type	Word Unsignec	ct designation

At this time, the input box can set the value of PSW0, but the box displays the value of PSW1. For example: input 1 to PSW0, PSW0 still displays 0, and PSW1 displays 1.



■ Data input

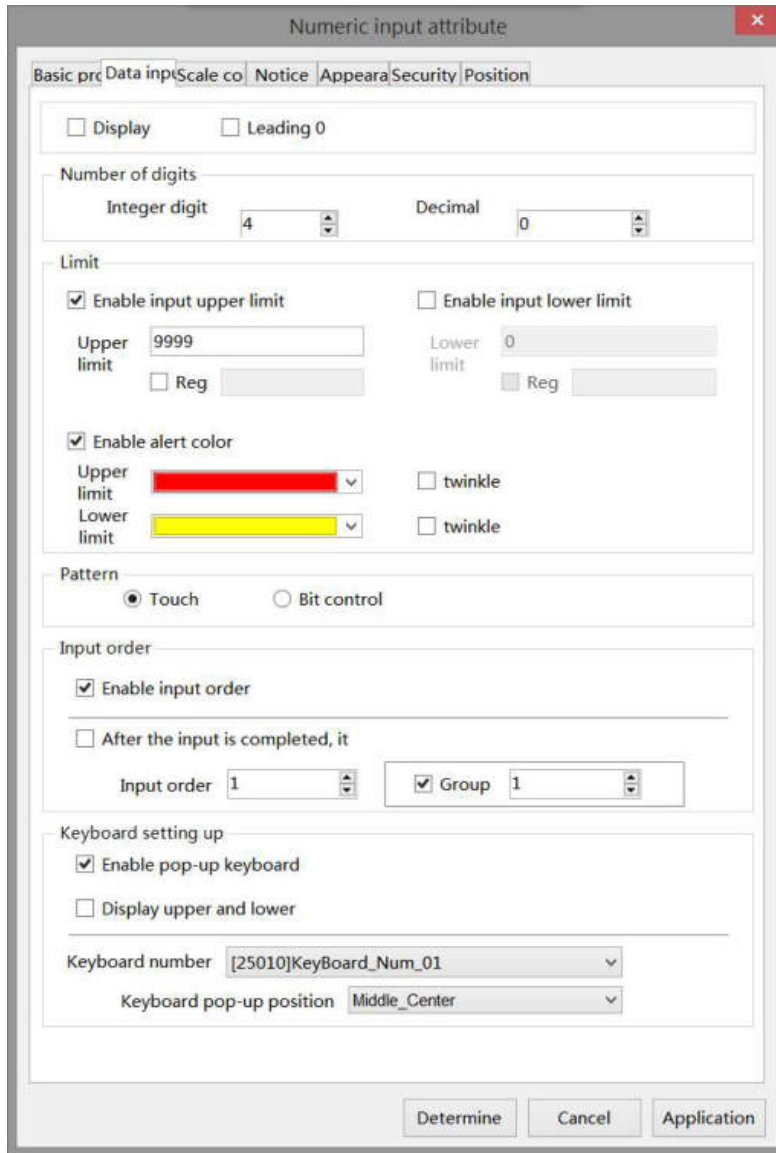

Display	After checking, the user will not see the entered value, and the value will be displayed as "* * *"						
Leading 0	If the number of data digits does not meet the requirements, it shall be supplemented with 0 in front (For example, if the integer digits and decimal digits are set as 5 and 0 respectively for data input, and the leading 0 is selected, the input data will be 23 and 00023 will be displayed in the input box)						
Number of digits	Set the integer and decimal digits displayed in the register						
Limit	<table border="0"> <tr> <td>Enable input upper limit</td> <td>Set the upper limit of data input, which can also be specified by register</td> </tr> <tr> <td>Enable input lower limit</td> <td>Set the lower limit of data input, which can also be specified by register.</td> </tr> <tr> <td>Enable alert color</td> <td>Set the warning color of upper and lower limits and whether it flickers</td> </tr> </table>	Enable input upper limit	Set the upper limit of data input, which can also be specified by register	Enable input lower limit	Set the lower limit of data input, which can also be specified by register.	Enable alert color	Set the warning color of upper and lower limits and whether it flickers
	Enable input upper limit	Set the upper limit of data input, which can also be specified by register					
	Enable input lower limit	Set the lower limit of data input, which can also be specified by register.					
Enable alert color	Set the warning color of upper and lower limits and whether it flickers						
<table border="0"> <tr> <td>input upper limit</td> <td>If the upper limit is set to 10, 10 can be entered normally according to the input sequence, and 11 is not allowed to be entered.</td> </tr> <tr> <td>input lower limit</td> <td>If the lower limit is set to 10, you can normally enter a value of 10 or more. If you enter a value below 10, the value in the current register will be displayed</td> </tr> </table>	input upper limit	If the upper limit is set to 10, 10 can be entered normally according to the input sequence, and 11 is not allowed to be entered.	input lower limit	If the lower limit is set to 10, you can normally enter a value of 10 or more. If you enter a value below 10, the value in the current register will be displayed			
input upper limit	If the upper limit is set to 10, 10 can be entered normally according to the input sequence, and 11 is not allowed to be entered.						
input lower limit	If the lower limit is set to 10, you can normally enter a value of 10 or more. If you enter a value below 10, the value in the current register will be displayed						
<table border="0"> <tr> <td>alert color</td> <td>If the same register is used in other locations and exceeds the upper and lower limits set by this register, a warning prompt will be triggered</td> </tr> </table>	alert color	If the same register is used in other locations and exceeds the upper and lower limits set by this register, a warning prompt will be triggered					
alert color	If the same register is used in other locations and exceeds the upper and lower limits set by this register, a warning prompt will be triggered						

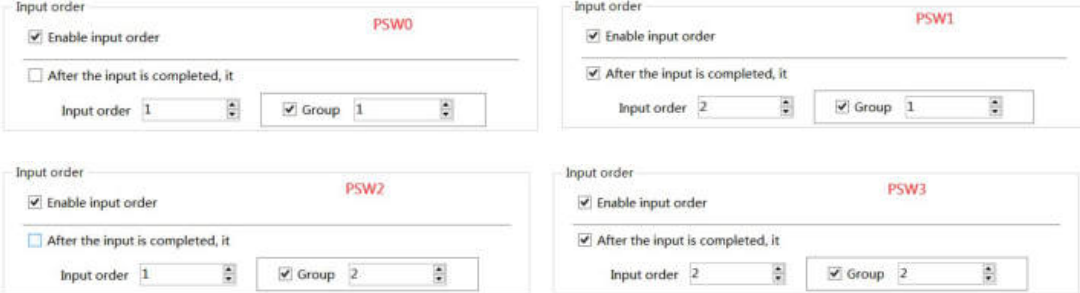
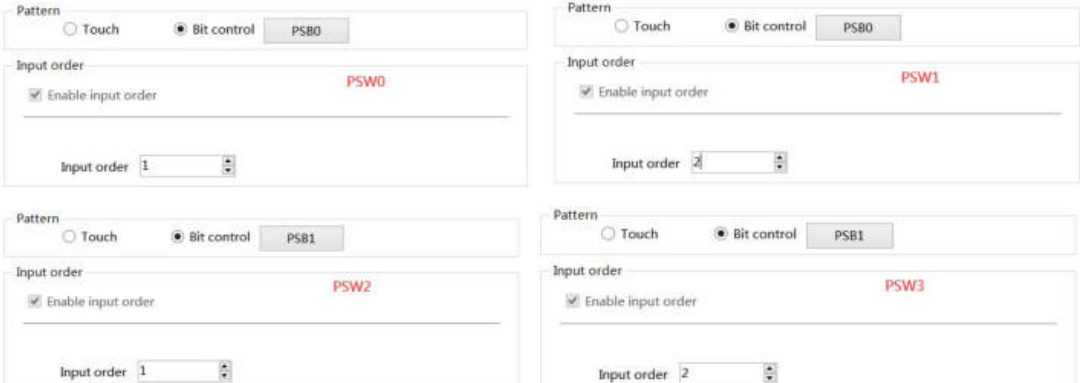
Pattern	<p>There are touch control and bit control. Touch control means to start the input program by touching the control. For bit control, start the input program when the specified coil is ON. In bit control state, when the coil is ON, trigger the keyboard to pop up, click ENT to input data, and click ESC to cancel the keyboard pop up</p>
Input order	<p>If it is enabled, the keyboard will jump to the corresponding input control in order to set different groups.</p> <p>Example 1 (touch control): The data input controls PSW0, PSW1, PSW2 and PSW3 are set as follows.</p>  <p>PSW0 and PSW1 are in same group, and the order is 1 and 2 respectively; PSW2 and PSW3 are in same group, and the order is 1 and 2 respectively;</p> <p>When you click PSW0, the keyboard will pop up. After entering the value, click ENT, the keyboard will automatically jump to PSW1. After entering the value, click ENT to complete the value input of PSW0 and PSW1 (if you check "No more input in sequence after input", the keyboard will not jump to the next component in the same group after completing the input at the selected component. If you want to input, you need to click the next component again for input); Similarly, enter PSW2 and PSW3.</p> <p>Example 2 (bit control): The data input controls PSW0, PSW1, PSW2 and PSW3 are set as follows.</p>  <p>PSW0 and PSW1 are in same group, which are controlled by coil PSB0, and the sequence is 1 and 2 respectively; PSW2 and PSW3 are in same group, which are controlled by coil PSB1 in order of 1 and 2 respectively;</p> <p>When PSB0 and PSB1 are set to OFF, clicking PSW0, 1, 2 and 3 will not pop up the keyboard.</p> <p>When PSB1 is set to OFF and PSB0 is set to ON, the keyboard will jump out for PSW0. After entering the value, click ENT, the keyboard will automatically jump to PSW1. After entering the value, click ENT to complete the value input of PSW0 and PSW1; Similarly, when PSB0 is set to OFF, PSW2 and PSW3 are input when PSB1 is set to ON.</p> <p>When PSB0 and PSB1 are both set to ON, the input program will be triggered in the order of PSW0, PSW2, PSW1 and PSW3. To cancel the input point ESC.</p>



1. The keyboard pops up when the control coil is set to ON. After input, the control coil (PSB0, PSB1) will not reset automatically. If you want to re-enter data, please manually reset to ON to trigger.
2. It is recommended that the control coil be set to reverse state. If it is set to instantaneous ON, take PSW0 and PSW1 above as an example. If PSB0 is set to instantaneous ON, a keyboard will pop up for PSW0 at the same time of triggering. Click ENT after input, and the keyboard will disappear. Only PSW0 can be input. Even if it is triggered again, the keyboard will only be displayed below PSW0, and the setting of PSW1 cannot be completed.

Action

Set on
 Set off
 Reverse
 Instantaneous on

Keyboard setting

Set whether to pop up the keyboard, keyboard style selection, keyboard pop-up position, whether to display upper and lower limit values, etc



1. The keyboard suffix UL is the keyboard with upper and lower limits, such as **【25009】KeyBoard_Num_01UL**
2. Users can also customize the keyboard.

① Select the project tree - user form, right-click Add to create a new user form.

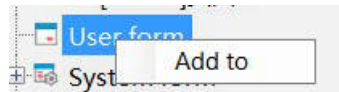

② "Used as keyboard display" should be selected for name and size of user-defined system form .

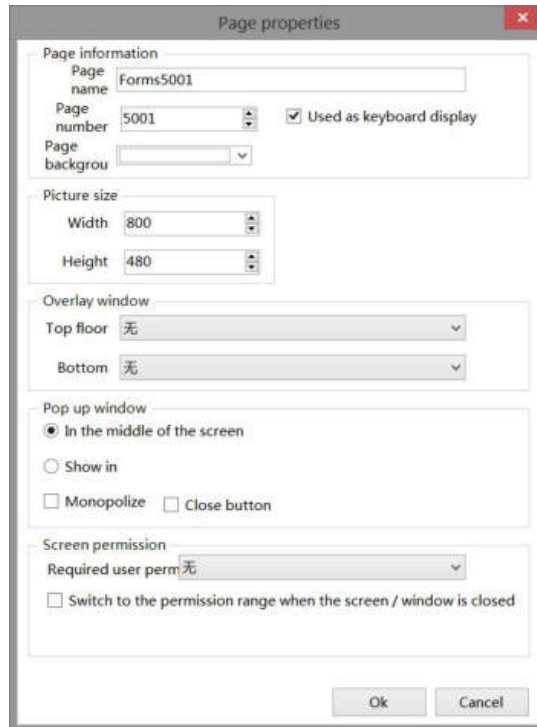

③ Place the required character keys on the user form. Refer to 4-2-12 for the use of character keys. In the following example, 0-9, ESC and ENT keys are placed.



④ Open the numeric input control, and a newly created "User defined keyboard" will appear at the keyboard number. After selecting, click OK



⑤ At this time, click the numeric input control, and the displayed keyboard is the keyboard defined by yourself

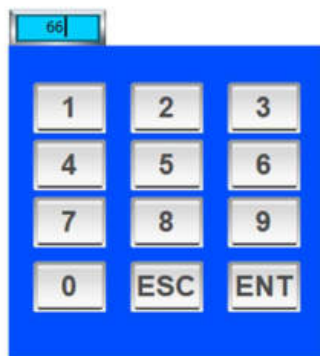

■ Scale conversion

It is divided into input scale conversion and display scale conversion. After checking, the input or read value can be converted according to the set scale; The conversion effect can be simulated in the software, as shown below:

Numeric input attribute x

Basic prc | Data inp | Scale cor | Notice | Appeara | Security | Position

Input scale conversion

<p>Data source</p> <p>Upper limit <input type="text" value="9999"/></p> <p><input type="checkbox"/> Reg <input type="text"/></p> <p>Lower limit <input type="text" value="0"/></p> <p><input type="checkbox"/> Reg <input type="text"/></p>	<p>Conversion value</p> <p>Upper limit <input type="text" value="9999"/></p> <p><input type="checkbox"/> Reg <input type="text"/></p> <p>Lower limit <input type="text" value="0"/></p> <p><input type="checkbox"/> Reg <input type="text"/></p>
---	--

Preview

设备值	Lower limit of	HMI	Data source	Upper limit	Lower limit
0	= 0	+	0	-	0
) x		
			9999 - 0		
			9999 - 0		
			Data source	Data source	

Display scale conversion

<p>Data source</p> <p>Upper limit <input type="text" value="9999"/></p> <p><input type="checkbox"/> Reg <input type="text"/></p> <p>Lower limit <input type="text" value="0"/></p> <p><input type="checkbox"/> Reg <input type="text"/></p>	<p>Conversion value</p> <p>Upper limit <input type="text" value="9999"/></p> <p><input type="checkbox"/> Reg <input type="text"/></p> <p>Lower limit <input type="text" value="0"/></p> <p><input type="checkbox"/> Reg <input type="text"/></p>
---	--

Preview

HMI	Lower limit of	设备值	Data source	Upper limit	Lower limit
0	= 0	+	0	-	0
) x		
			9999 - 0		
			9999 - 0		
			Data source	Data source	

Input scale conversion	The input data is obtained from the original data in the operating object register after conversion. To select this function, you need to set the upper and lower limits of the data source and conversion value. The upper and lower limits can be constant or specified by the register. The data source is the data input on the HMI, and the conversion value is the data written into the lower communication device after proportional conversion
Display scale conversion	The display data is obtained from the original data in the monitoring object register after conversion. Selecting this function requires setting the upper and lower limits of the data source and conversion value. The upper and lower limits can be constant or specified by the register. The data source is the data in the lower communication equipment, and the conversion value is the data displayed on the HMI after proportional conversion
Upper lower limit	Limit the upper and lower limits of the input (can be specified through the register)



If the “enable input upper/lower limit”(as shown in the left figure below) and “input/display scale

conversion” (as shown in the right figure below) are checked at the same time, the upper and lower limits of data display are the upper and lower limits of scale conversion.

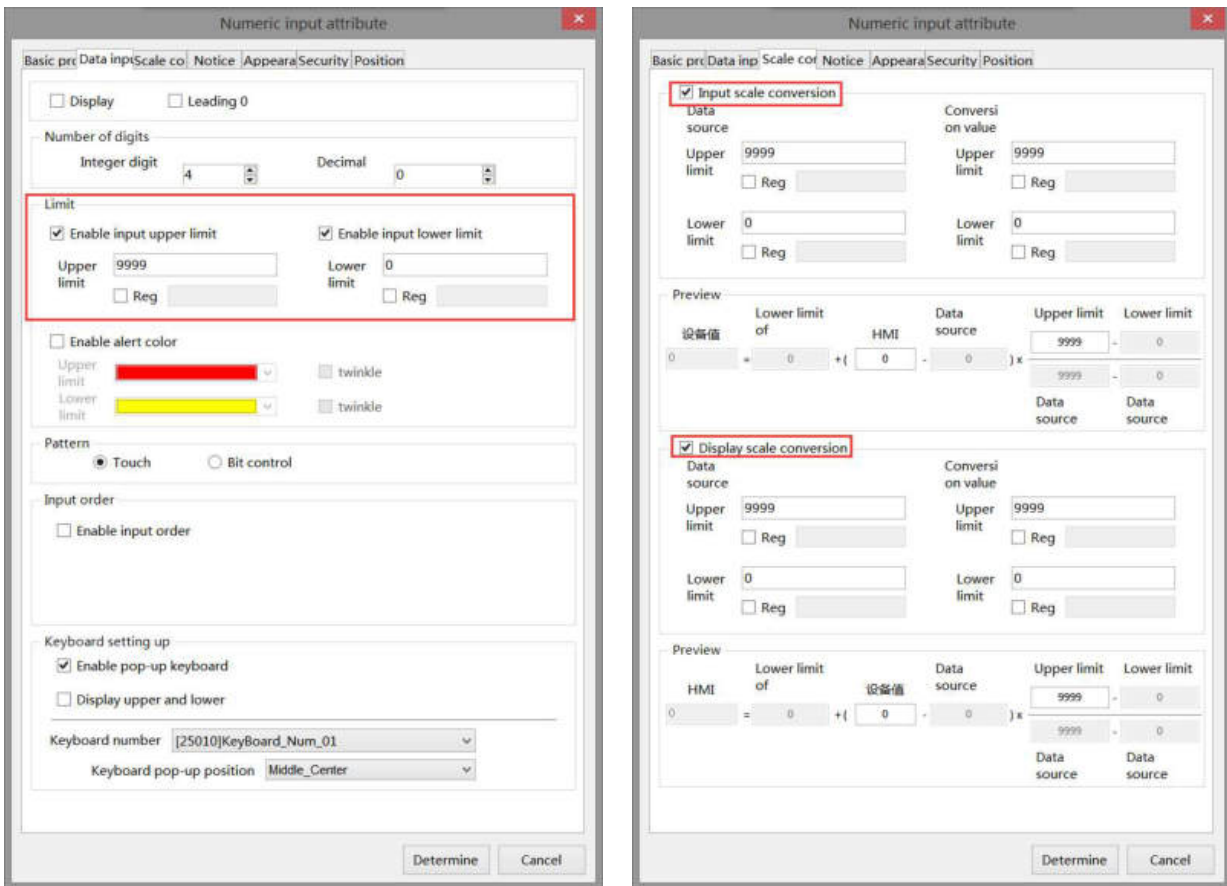

■ Notice

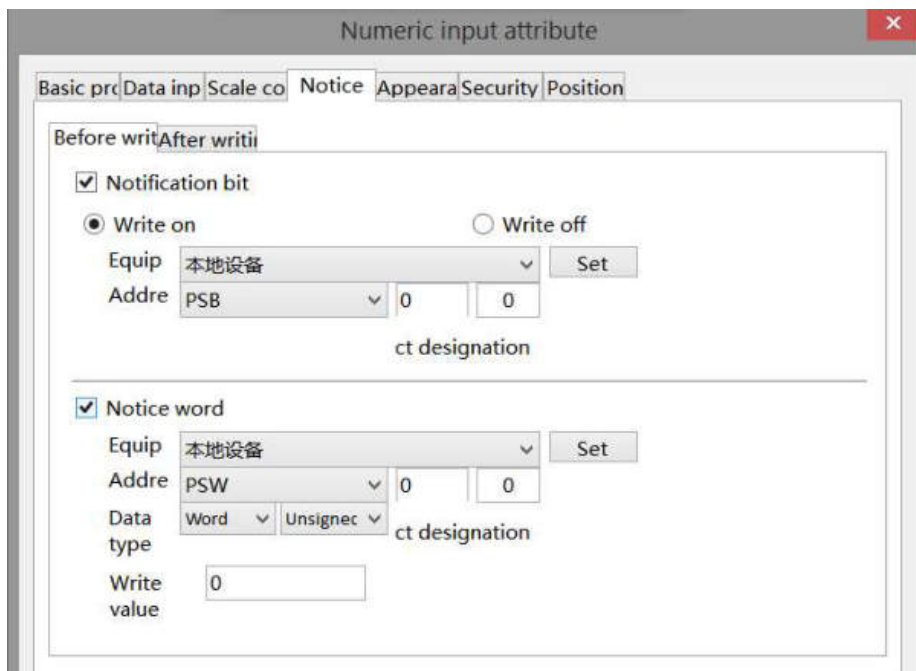

Notice	If selected “notification bit” or “notice word”, the coil can be set ON/OFF, the register can be set value (notice word) before or after writing.
--------	---

■ Appearance

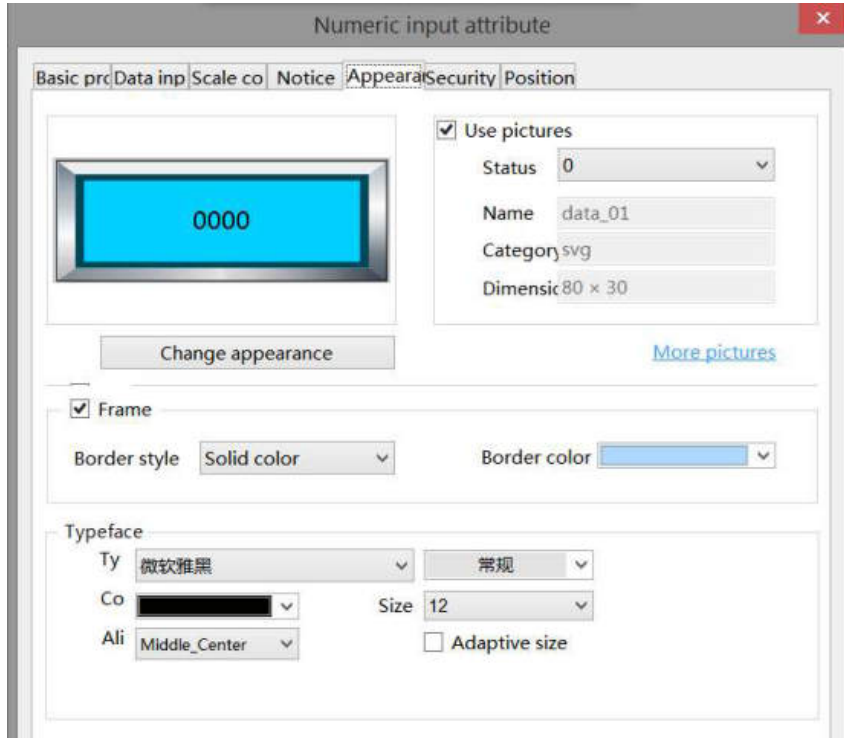

Use picture	Set whether to use pictures
Change appearance	You can click "Change Appearance" to change the appearance, or click "More Pictures" to select a custom picture
Fill	Fill style (solid/gradient) and fill color can be set
Frame	Border style and color can be set
Typeface	You can set the font, size, color and display position of the font in the control (you can also check the adaptive size, that is, drag the mouse to change the size of the part, and the number size will change accordingly)

■ Security setting

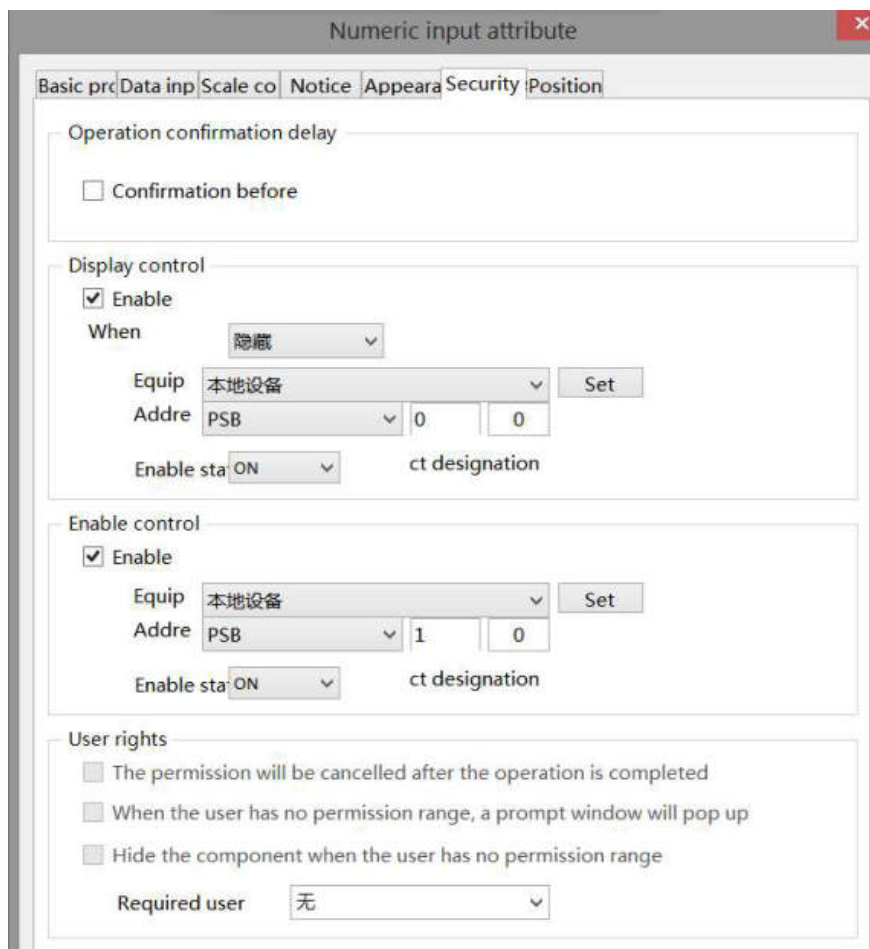

Operation confirmation delay	The waiting time (s) can be set. If this option is checked, a pop-up window "Are you sure to execute this operation" will pop up when operating components. If you do not click "OK" or "Cancel" within the set waiting time, the pop-up window will disappear by itself and this operation will fail. If you click "OK" within the waiting time, the operation is successful. Clicking "Cancel" is invalid
Display control	Use bits to control whether to display the part. When the condition is not met, the component will be hidden
Enable	After selected, it will perform the display control
When validation fails	When validation fails, the component is hidden by default and cannot be changed
Address	Set the target coil of bit control
Enable status	Set ON status to be valid or OFF status to be valid. For example: if the equipment is checked as shown in the above figure, the bit control is PSB0, and it is hidden when validation fails, and the enable status is ON, then when the status of PSB0 is ON, the component is normally displayed, and when the status of PSB0 is OFF, the component is hidden and not displayed.
Enable control	The bit limit can be set (the enable state of the enable control can be customized). When the enabling conditions are met, the component can be used normally (as shown in the figure above: when the PSB1 is in the ON state and the trigger conditions are met at the same time, the component can be used; if the PSB1 is in the OFF state, the component is still unavailable even if the trigger conditions are met)
Indirect assignment	Set the current address offset. The current coil address changes with the indirectly specified register value, that is, $Dx [Dy]=D [x+Dy \text{ value}]$ ($x, y=0, 1, 2, 3\dots$). For example, the current

	coil address is PSB0, if the indirectly assigned address is PSW100; When the value of PSW100 register is 0, the coil controlling this element is still PSB0; When the value of PSW100 register is 1, the coil controlling this element is PSB1 (and so on)
User rights	<p>Set the controlled authority level.</p> <p>After setting the permission range of the required user, the following three functions can be checked as required:</p> <p>(1) Cancel the permission after the operation: if this option is not checked, the corresponding level password must be entered for each operation of this part. After checking, you only need to enter it successfully once.</p> <p>(2) When the user has no permission range, a prompt window will pop up.</p> <p>(3) When the user has no permission range, hide the component.</p>



There are several combinations when logging in: (For the use of user rights, see chapter 3-3-1. File - System Settings – user rights)

When a user logs in and does not migrate out, his/her permissions will remain. If you migrate out, the user will have no corresponding permission.

(1) When the user has no permission range, a prompt window will pop up

User rights

The permission will be cancelled after the operation is completed

When the user has no permission range, a prompt window will pop up

Hide the component when the user has no permission range

Required user: 权限1

When this option is checked, if the user rights is not logged in, clicking the control will pop up a prompt window:



Click User Login, and it can be used normally after successful login. If the user has logged in and has this permission, he can directly operate the component without a prompt window.

(2) Hide the component when the user has no permission range

User rights

The permission will be cancelled after the operation is completed

When the user has no permission range, a prompt window will pop up

Hide the component when the user has no permission range

Required user: 权限1

When this option is checked, the component will be hidden if there is no login user permission; If the user has logged in, the component will display normally.

(3) The permission will be cancelled after the operation is completed & When the user has no permission

range, a prompt window will pop up.

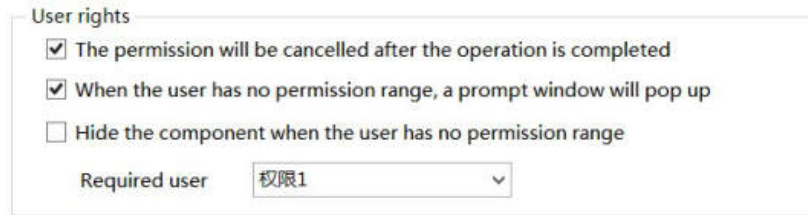

When this option is checked, if the user rights is not logged in, click the component and a prompt window will pop up:



Click the user log in. After logging in successfully, operate the component once. After the first operation, the system automatically cancels the permission limit of the component. Even after logging out, the component can be clicked normally. If the user has logged in, the component will display normally, and clicking the component will not pop up a prompt window.

- (4) The permission will be cancelled after the operation is completed & Hide the component when the user has no permission range.



When this option is checked, if user rights is not logged in, the component will be hidden. After successful login, the component will be operated once. After the first operation, the system will automatically cancel the permission limit of the component. Even after logging out, the component will not be hidden. If the user has logged in, the component will display normally.

■ Position

Same to chapter 4-1-1 straight line position part.

4-2-4. Numerical display

1. Click the "Part/Display/Numerical Display" in the menu bar or the  icon in the basic part bar of the control window, move the cursor to the screen, click the left mouse button to place it, click the right mouse button or click ESC to cancel it. Modify the length and width of the border through the border points.
2. When setting attributes, you can set them in the attribute box that pops up when placing components. You can also double-click numerical display or select numerical display, right-click, and select Attribute.

■ Basic property

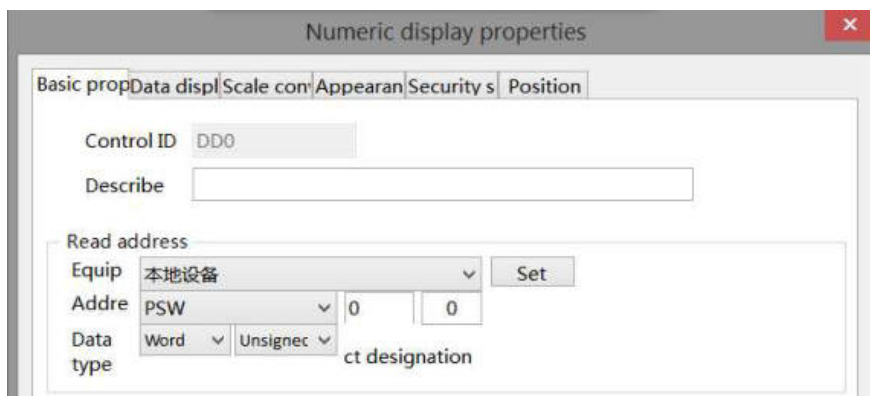

Control ID	It is used for system management control and cannot be operated by users
Describe	Can be used to comment on the purpose of this component
Read address	Set the displayed address. At the same time, set whether there is offset (i.e., indirect assignment)
Equipment	Current equipment port for communication
Address	Set target register number
Data type	Byte-8Bit, Word-16Bit, DWord- 32Bit, DDWord -64Bit, BCD format, Hex, Signed, Unsigned, Floating number
Set	Click "Set" to enter the address setting interface, where you can set and use system registers and user-defined tags. You can click the address tag library below or the project tree - library - address tag library to set the tags (see chapter 5-2 Address Tag Library for the use of address tag library and user-defined tags)
Indirect assignment	Set the current address offset. The current register address changes with the indirectly specified register value, that is, $Dx [Dy]=D [x+Dy \text{ value}]$ ($x, y=0, 1, 2, 3\dots$). For example: the current register address is PSW0, if the indirectly specified address is PSW100; When the value of PSW100 register is 0, the register controlling this element is still PSW0; When the value of PSW100 register is 1, the register controlling this element is PSW1 (and so on)

■ Data display

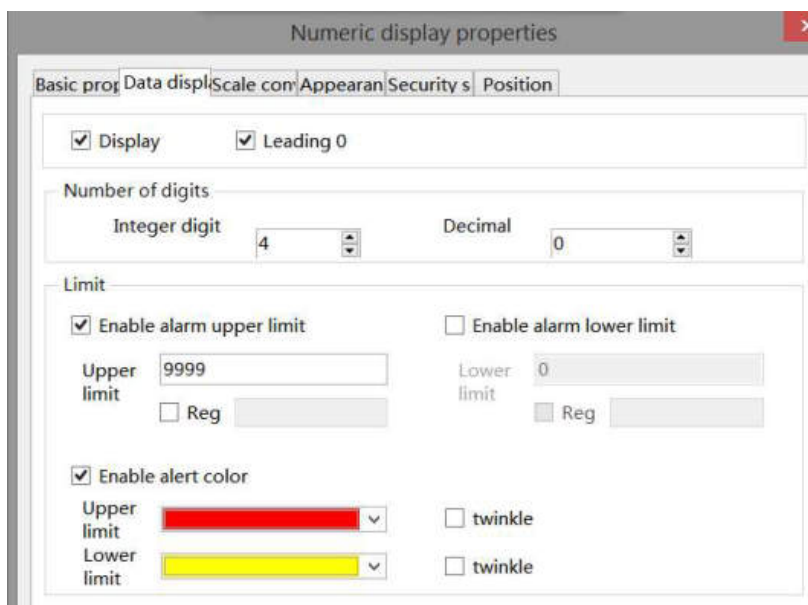

Display	After checking, the user will not see the entered value, and the value will be displayed as "*" *"	
Leading 0	If the number of data digits does not meet the requirements, it shall be supplemented with 0 in front (For example: the integer digits and decimal digits are set as 5 and 0 respectively for data display. When leading 0 is selected, enter 23 and 00023 will be displayed in the input box)	
Number of digits	Set the integer and decimal digits displayed in the register	
Limit	Enable alarm upper limit	Set the upper limit of alarm input, which can be specified by register
	Enable alarm lower limit	Set the lower limit of alarm input, which can be specified by register
	Enable alert color	Set the warning color of the upper and lower limits and whether it flickers

■ Scale conversion

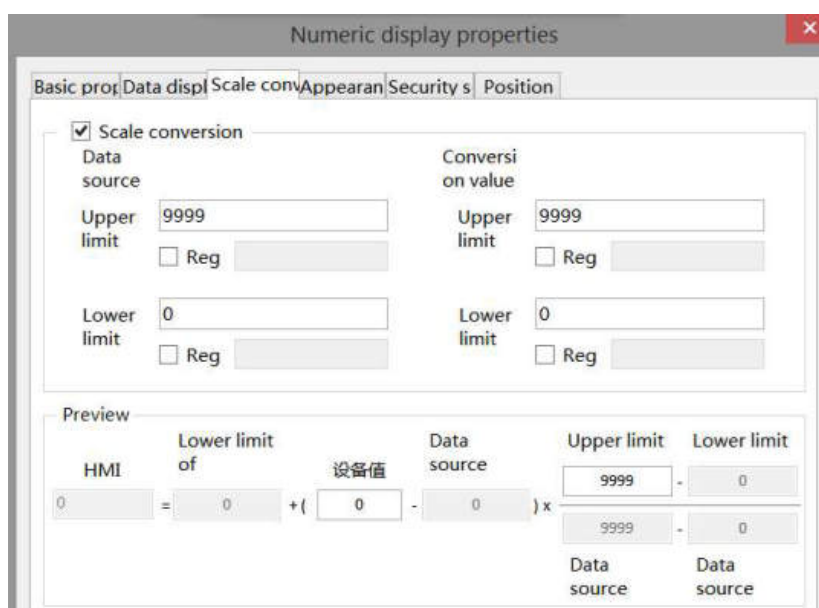

Scale conversion	Set whether to perform scale conversion. After checking, the read value can be converted according to the set scale, and the conversion effect can be previewed in the software
------------------	---

	The display data is obtained from the original data in the monitoring object register after conversion. Selecting this function requires setting the upper and lower limits of the data source and conversion value. The upper and lower limits can be constant or specified by the register. The data source is the data in the lower communication equipment, and the conversion value is the data displayed on the HMI after proportional conversion
Upper/lower limit	Limit the upper and lower limits of data (can be specified by register)

■ Appearance

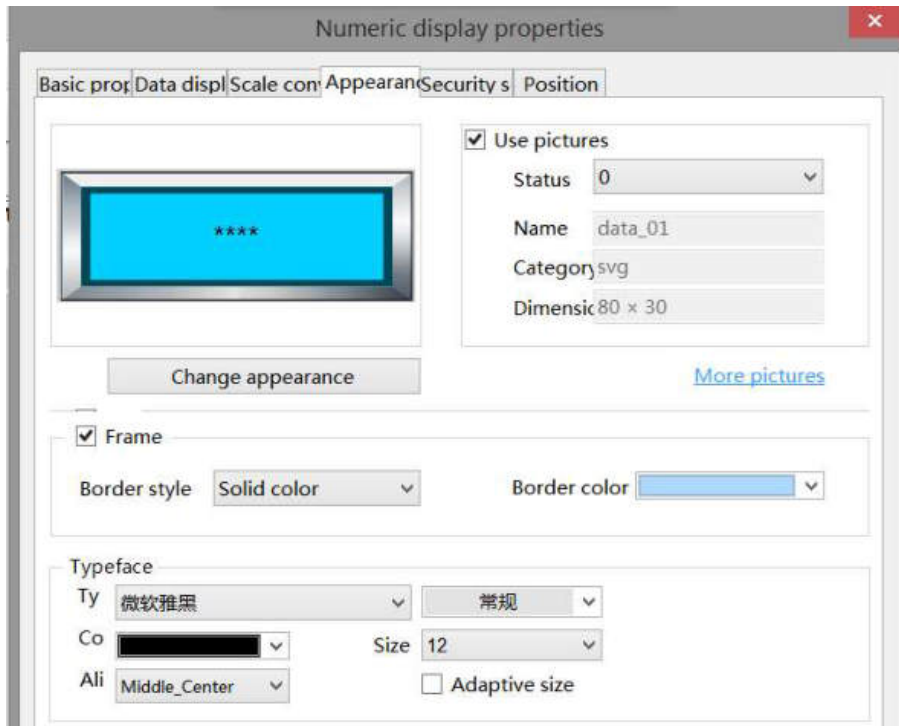

Same to chapter 4-2-3 numerical input appearance part.

■ Security setting

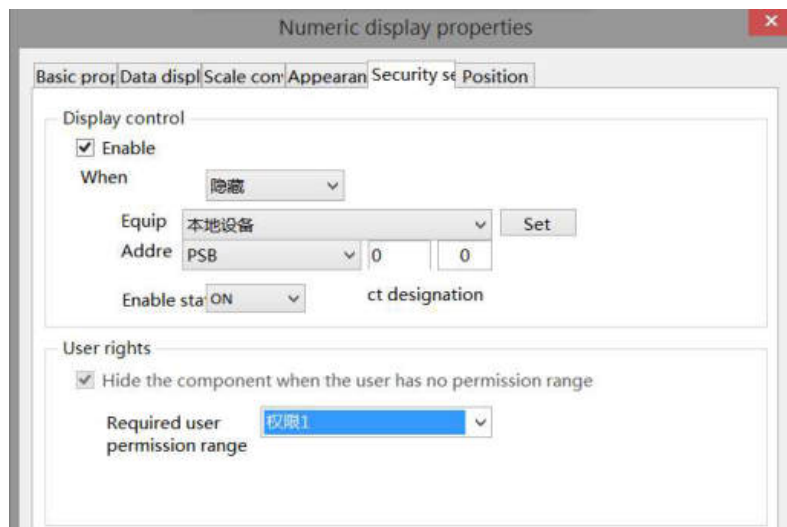

Same to chapter 4-2-3 numerical input security setting part.

■ Position









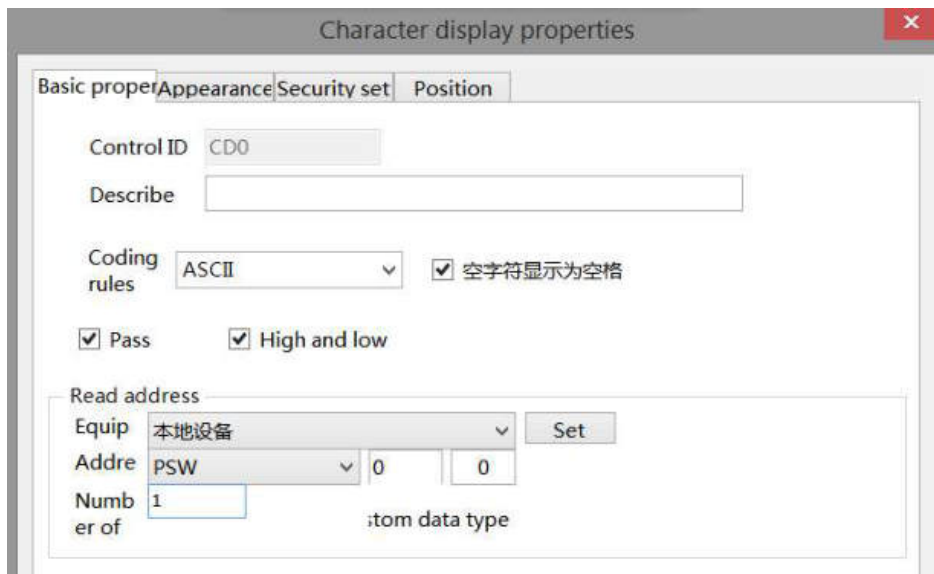



Same to chapter 4-1-1 straight line position part.

4-2-5. Character input

1. Click the "Part/Input/Character Input" icon in the menu bar or the  icon in the basic part bar of the control window, move the cursor to the screen, click the left mouse button to place it, click the right mouse button or click ESC to cancel it. Modify the length and width of the border through the border points.
2. When setting attributes, you can set them in the attribute box that pops up when placing components, or you can double-click character input or select character input and right-click to select Attribute.

■ Basic property

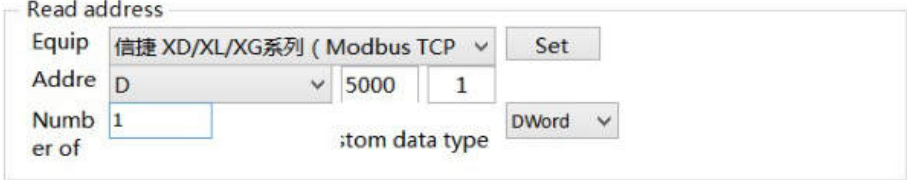
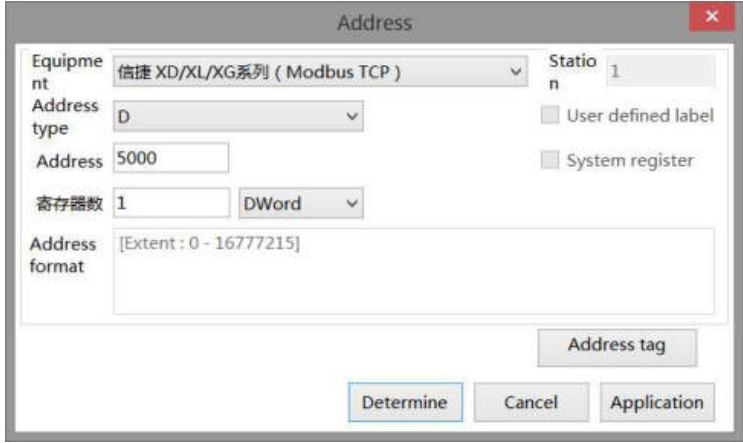

Control ID	It is used for system management control and cannot be operated by users									
Describe	Can be used to comment on the purpose of this component									
Coding rules	ASCII (select "blank characters are displayed as spaces"), UTF-8 and UTF-16 encoding rules can be selected									
Password	After checking, the user will not see the entered value, and the value will be displayed as "*" *"									
High and low	<p>After checking, the display order is changed to "low byte+high byte"</p> <table border="0" style="margin-left: auto; margin-right: auto;"> <thead> <tr> <th style="text-align: left;">Character</th> <th style="text-align: left;">Input</th> <th style="text-align: left;">Display</th> </tr> </thead> <tbody> <tr> <td>not selected high and low</td> <td> A</td> <td> C</td> </tr> <tr> <td>select high and low</td> <td> B</td> <td> D</td> </tr> </tbody> </table> <p>ABCD is set to DWORD type of the same address. Input abcd to A normally, then A and C display abcd, and B/D displays badc because high/low byte conversion is checked. Input abcd to B normally. At this time, B and D display abcd, and A/C displays badc because high/low byte conversion is not checked.</p>	Character	Input	Display	not selected high and low	 A	 C	select high and low	 B	 D
Character	Input	Display								
not selected high and low	 A	 C								
select high and low	 B	 D								

	<p>Note: 1. Taking Xinje PLC as an example, the display of characters in the monitor is consistent with that of characters without checking high/low byte conversion.</p> <p>2. High low byte conversion refers to the conversion of both input and display of character. Check the character input of high-low byte conversion. When using the keyboard to input ab, perform high-low byte conversion, write ba into the register, read ba from the register when reading, and then perform high-low byte conversion to display ab</p>
Read address	<p>Set the read/write address (refer to chapter 4-2-3 Numerical Input for the description of the read/write address)</p> 
Equipment	Current equipment port for communication
Address	Set target register number
Register number	Set the character input length. One register can display two characters
Custom data type	The default is Word. If it is checked, it can be customized as DWord and DDDWord (note that the data type selected here should be exactly corresponding to the data type used by the PLC during monitoring, otherwise the characters will be displayed opposite to the high and low bytes of monitoring)
Set	<p>Click "Set" to enter the address setting interface, which can also be used to set system registers. Character input/character display temporarily does not support the use of address tag library.</p> 

■ Character input

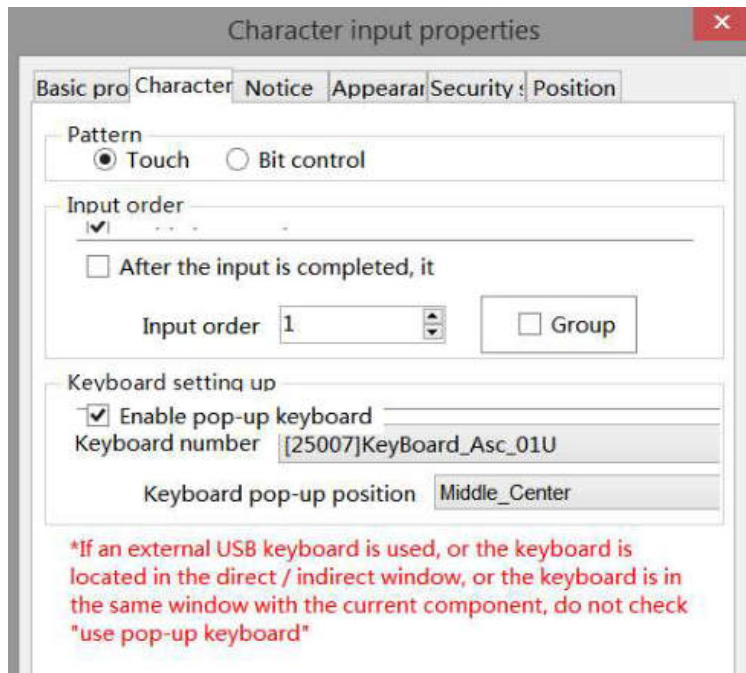

<p>Pattern</p>	<p>There are touch control and bit control. Touch means to start the input program by touching the component, and bit control means to start the input program when the specified coil is ON. In the bit control state, when the coil reaches ON, trigger the keyboard to pop up, click ENT to enter data, and click ESC to cancel the keyboard pop up.</p>
<p>Input order</p>	<p>If it is enabled, the keyboard will jump to the corresponding input component, it can set different groups.</p> <p>Example 1 (touch control): The character input component PSW0, PSW1, PSW2 and PSW3 are set as follows:</p> <div data-bbox="331 1205 1428 1505" data-label="Image"> </div> <p>PSW0 and PSW1 are in same group, and the order is 1 and 2 respectively; PSW2 and PSW3 are in same group, and the order is 1 and 2 respectively.</p> <p>When you click PSW0, the keyboard will pop up. After entering characters, click ENT, the keyboard will automatically jump to the bottom of PSW1. After entering characters, click ENT to complete the character input of PSW0 and PSW1 (if you check "No more input in sequence after input", the keyboard will not jump to the next component in the same group after completing the input at the selected component, and if you want to input, you need to click the next component again for input); Similarly, enter PSW2 and PSW3.</p> <p>Example 2 (bit control): The character input component PSW0, PSW1, PSW2 and PSW3 are set as follows.</p>

The image shows four screenshots of a control interface for PSW0, PSW1, PSW2, and PSW3. Each screenshot displays a 'Pattern' section with 'Touch' and 'Bit control' radio buttons, a coil name (PSB0 or PSB1), and a PSW name. Below is an 'Input order' section with a dropdown menu.

- PSW0: Bit control selected, PSB0, PSW0, Input order 1
- PSW1: Bit control selected, PSB0, PSW1, Input order 2
- PSW2: Bit control selected, PSB1, PSW2, Input order 1
- PSW3: Bit control selected, PSB1, PSW3, Input order 2

PSW0 and PSW1 are in same group, which are controlled by coil PSB0, and the sequence is 1 and 2 respectively; PSW2 and PSW3 are in same group, which are controlled by coil PSB1 in order of 1 and 2 respectively;

When PSB0 and PSB1 are set to OFF, clicking PSW0, 1, 2 and 3 will not pop out the keyboard.

When PSB1 is set to OFF and PSB0 is set to ON, the keyboard will jump out under PSW0. After input, press ENT, the keyboard will automatically jump to the bottom of PSW1. After input, press ENT to complete the input of PSW0 and PSW1; Similarly, when PSB0 is set to OFF, PSW2 and PSW3 are input when PSB1 is set to ON.

When PSB0 and PSB1 are both set to ON, the input program will be triggered in the order of PSW0, PSW2, PSW1 and PSW3. Click ESC to cancel the input.



1. The keyboard pops up when the control coil is set to ON. After input, the control coil (PSB0, PSB1) will not reset automatically. If you want to re-enter data, please manually reset and trigger again.

2. It is recommended that the control coil be set to reverse state. If it is set to instantaneous ON, take PSW0 and PSW1 above as an example. If PSB0 is set to instantaneous ON, a keyboard will pop up below PSW0 at the same time of triggering. Click ENT after input, and the keyboard will disappear. Only PSW0 can be input. Even if it is triggered again, the keyboard will only be displayed below PSW0, and the setting of PSW1 cannot be completed.

Action

Set on
 Set off
 Reverse
 Instantaneous on

Keyboard setting up

Set whether to pop up the keyboard, keyboard style selection, and keyboard pop-up position

■ Notice

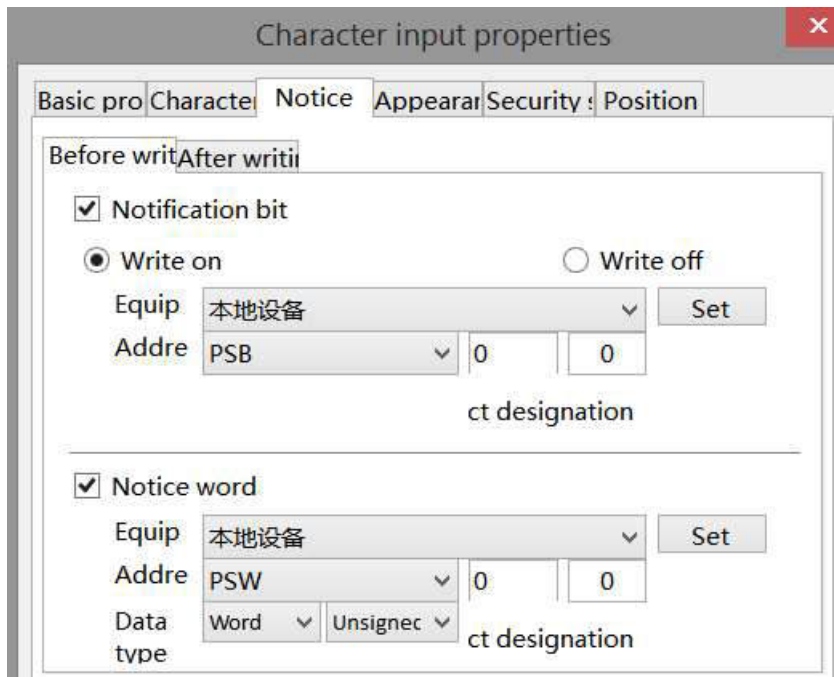

Notice	If Enable the notice, you can choose to set the target coil ON/OFF before/after writing, or set the target register to a constant (notification word) before or after writing. If Enable is not checked, the notification function will not take effect
--------	---

■ Appearance

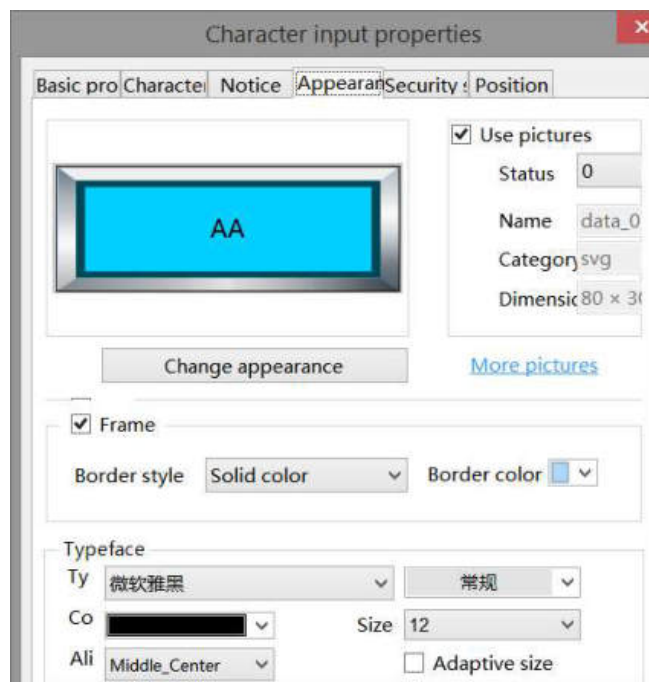

Same to chapter 4-2-3 numerical input appearance part.

■ Security setting



Same to chapter 4-2-3 numerical input security setting part.

■ Position

Same to chapter 4-1-1 straight line position part.

4-2-6. Character display

1. Click the "Part/Display/Character Display" in the menu bar or the  icon in the basic part bar of the control window, move the cursor to the screen, click the left mouse button to place it, click the right mouse button or click ESC to cancel it. Modify the length and width of the border through the border points.
2. When setting attributes, you can set them in the attribute box that pops up when placing components. You can also double-click Character Display or select Character Display, right-click, and select Attribute.

■ Basic

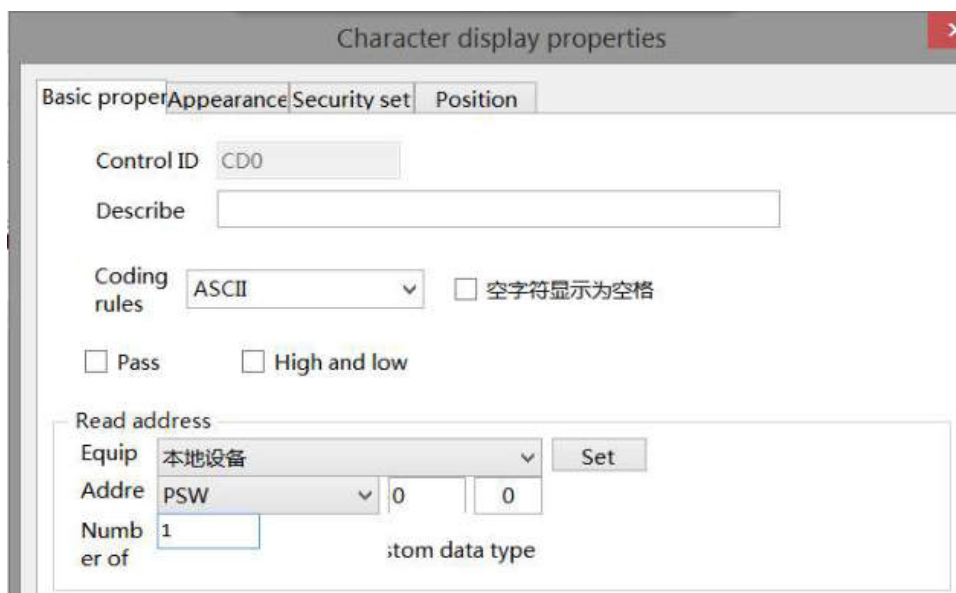

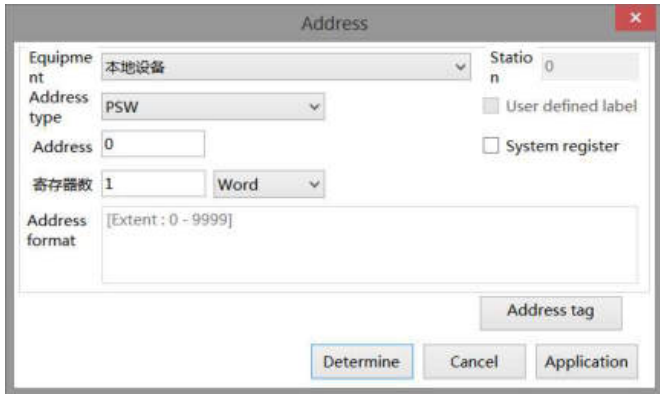
Control ID	It is used for system management control and cannot be operated by users									
Describe	Can be used to comment on the purpose of this component									
Coding rules	ASCII, UTF-8 and UTF-16 encoding rules can be selected									
Password	After checking, the user will not see the entered value, and the value will be displayed as "*" *"									
High and low	<p>After checking, the display order is changed to "low byte+high byte"</p> <table border="0" style="margin-left: auto; margin-right: auto;"> <thead> <tr> <th style="text-align: left;">Character</th> <th style="text-align: left;">Input</th> <th style="text-align: left;">Display</th> </tr> </thead> <tbody> <tr> <td>not selected high and low</td> <td><input type="text" value="abcd"/> A</td> <td><input type="text" value="abcd"/> C</td> </tr> <tr> <td>select high and low</td> <td><input type="text" value="badc"/> B</td> <td><input type="text" value="badc"/> D</td> </tr> </tbody> </table> <p>ABCD is set to DWORD type of the same address. Input abcd to A normally, then A and C display abcd, and B/D displays badc because high/low byte conversion is checked. Input abcd to B normally. At this time, B and D display abcd, and A/C displays badc because high/low byte conversion is not checked.</p> <p>Note: 1. Taking Xinje PLC as an example, the display of characters in the monitor is consistent with that of characters without checking high/low byte conversion. 2. High low byte conversion refers to the conversion of both input and display of character. Check the character input of high-low byte conversion. When using the keyboard to input ab, perform high-low byte conversion, write ba into the register, read ba from the register when reading, and then perform high-low byte conversion to display ab</p>	Character	Input	Display	not selected high and low	<input type="text" value="abcd"/> A	<input type="text" value="abcd"/> C	select high and low	<input type="text" value="badc"/> B	<input type="text" value="badc"/> D
Character	Input	Display								
not selected high and low	<input type="text" value="abcd"/> A	<input type="text" value="abcd"/> C								
select high and low	<input type="text" value="badc"/> B	<input type="text" value="badc"/> D								
Read address	Set the read address									
Equipment	Current equipment port for communication									
Address	Set target register number									
Register number	Set the character input length. One register can display two characters									
Custom data type	The default is Word. If it is checked, it can be customized as DWord and DWord (note that the data type selected here should be exactly corresponding to the data type used by the PLC during monitoring, otherwise the characters will be displayed opposite to the high and low bytes of monitoring)									
Set	<p>Click "Set" to enter the address setting interface, which can also be used to set system registers. Character input/character display temporarily does not support the use of address tag library</p> 									

■ Appearance

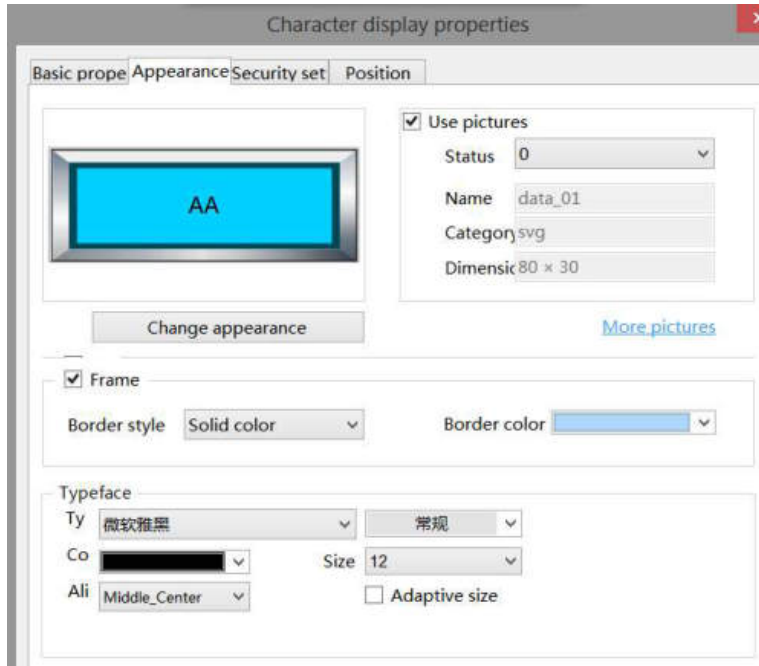

Same to chapter 4-2-3 numerical input appearance part.

■ Security setting

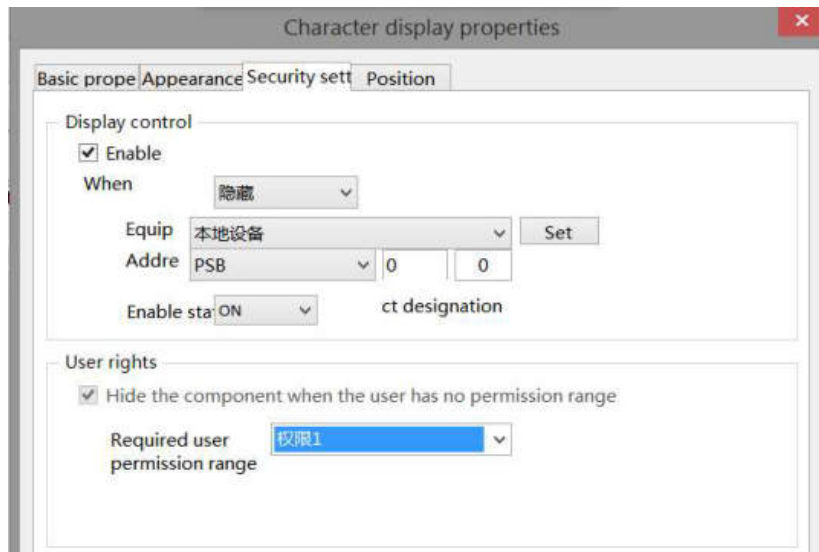

Same to chapter 4-1-1 straight line security setting part.

■ Position

Same to chapter 4-1-1 straight line position part.

4-2-7. Chinese input

1. Click the "Part/Input/Chinese Input" icon in the menu bar or the  icon in the basic part bar of the control window, move the cursor to the screen, click the left mouse button to place it, click the right mouse button or click ESC to cancel the placement. Modify the length and width of the border through the border points.

2. When setting attributes, you can set them in the attribute box that pops up when placing components, or you can double-click "Chinese Input" or select "Chinese Input" and right-click to select Attributes.

■ Basic property

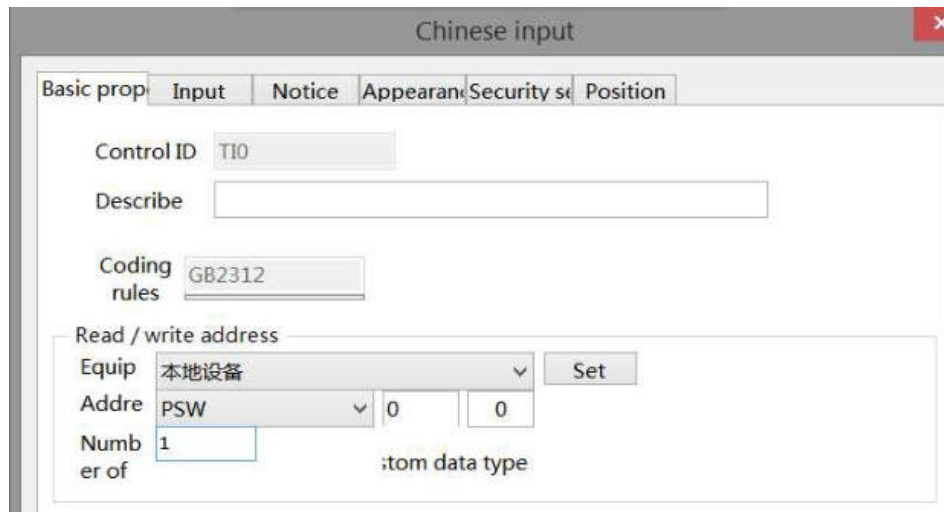

Control ID	It is used for system management control and cannot be operated by users
Describe	Can be used to comment on the purpose of this component
Coding rules	It defaults to GB2312 and cannot be modified
Read/write address	Set the read/write address (refer to chapter 4-2-3. description of read/write address of numerical input)
Equipment	Current equipment port for communication
Address	Set target register number
Register number	Setting character input length, different encoding rules, and different Chinese characters that can be displayed in one register; UTF-8: 3 registers can display 2 Chinese characters; GB2312, Unicode: 1 register can display 1 Chinese character.
Custom data type	The default is Word. If checked, it can be customized as DWord or DDWord
Set	Click "Set" to enter the address setting interface, where you can set and use system registers. Address tag library is not supported for Chinese input/Chinese display

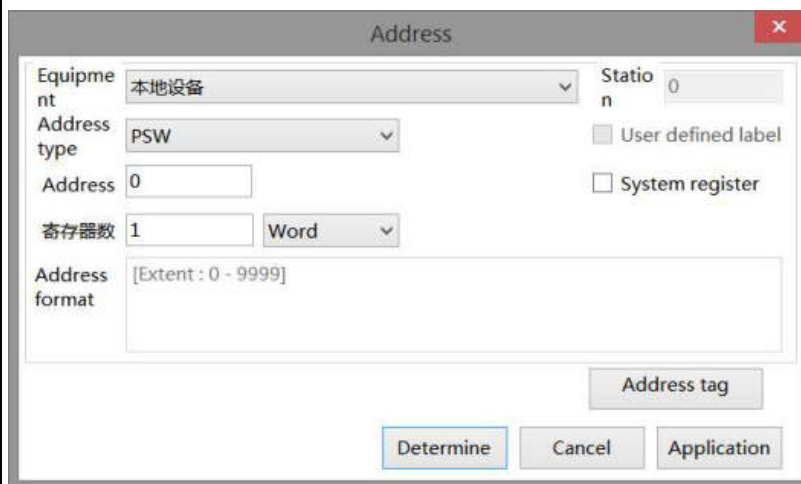

■ Input

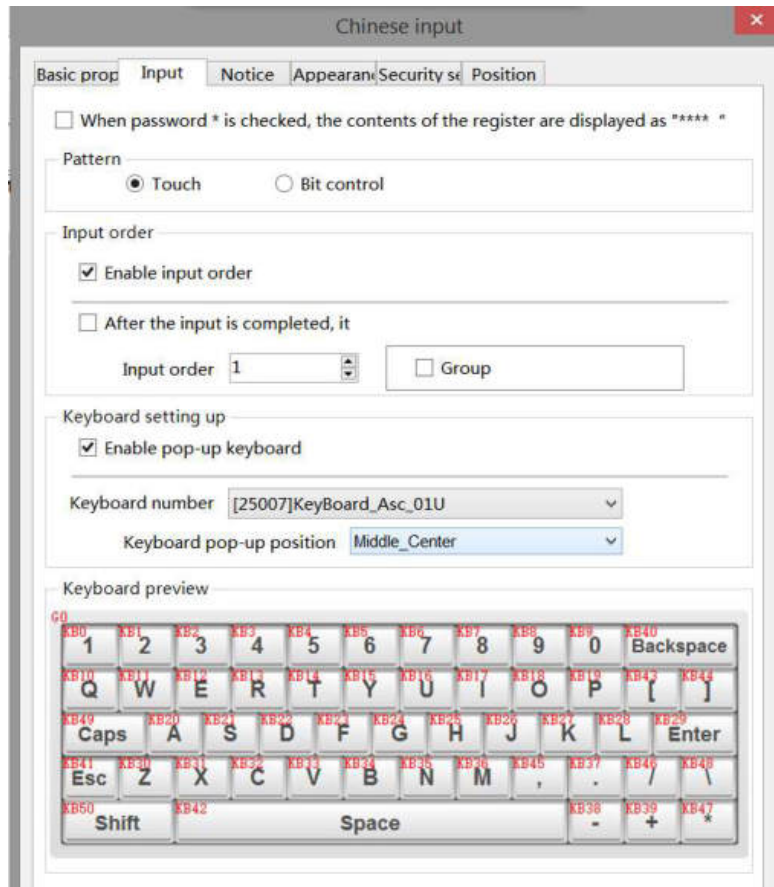

Password	After checking, the user will not see the entered text, and the text will be displayed as "* * *"
Pattern	There are touch control and bit control. Touch means to start the input program by touching the component, and bit control means to start the input program when the specified coil is ON. In the bit control state, when the coil reaches ON, trigger the keyboard to pop up, click ENT to enter data, and click ESC to cancel the keyboard pop up.
Input order	<p>If it is enabled, the keyboard will jump to the corresponding input component, it can set different groups.</p> <p>Example 1 (touch control): The Chinese input component PSW0, PSW1, PSW2 and PSW3 are set as follows:</p> <div style="display: flex; flex-wrap: wrap;"> <div style="width: 50%; border: 1px solid gray; padding: 5px; margin-bottom: 5px;"> <p>Input order PSW0</p> <p><input checked="" type="checkbox"/> After the input is completed, it</p> <p>Input order 1 <input type="checkbox"/> Group 1</p> </div> <div style="width: 50%; border: 1px solid gray; padding: 5px; margin-bottom: 5px;"> <p>Input order PSW1</p> <p><input checked="" type="checkbox"/> After the input is completed, it</p> <p>Input order 2 <input type="checkbox"/> Group 1</p> </div> <div style="width: 50%; border: 1px solid gray; padding: 5px; margin-bottom: 5px;"> <p>Input order PSW2</p> <p><input type="checkbox"/> After the input is completed, it</p> <p>Input order 1 <input type="checkbox"/> Group 2</p> </div> <div style="width: 50%; border: 1px solid gray; padding: 5px;"> <p>Input order PSW3</p> <p><input checked="" type="checkbox"/> After the input is completed, it</p> <p>Input order 2 <input type="checkbox"/> Group 2</p> </div> </div> <p>PSW0 and PSW1 are in same group, and the order is 1 and 2 respectively; PSW2 and PSW3 are in same group, and the order is 1 and 2 respectively.</p> <p>When you click PSW0, the keyboard will pop up. After entering characters, click ENT, the</p>

keyboard will automatically jump to the bottom of PSW1. After entering characters, click ENT to complete the character input of PSW0 and PSW1 (if you check "No more input in sequence after input", the keyboard will not jump to the next component in the same group after completing the input at the selected component, and if you want to input, you need to click the next component again for input); Similarly, enter PSW2 and PSW3.

Example 2 (bit control): The Chinese input component PSW0, PSW1, PSW2 and PSW3 are set as follows.

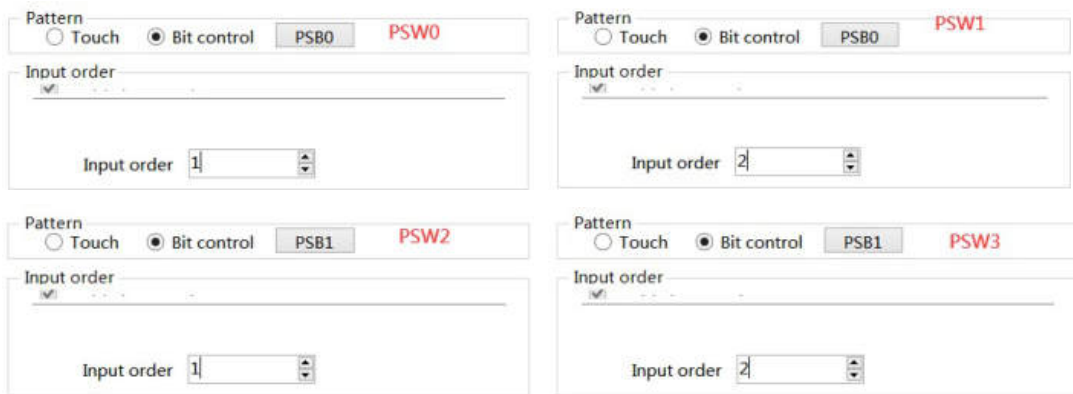

PSW0 and PSW1 are in same group, which are controlled by coil PSB0, and the sequence is 1 and 2 respectively; PSW2 and PSW3 are in same group, which are controlled by coil PSB1 in order of 1 and 2 respectively;

When PSB0 and PSB1 are set to OFF, clicking PSW0, 1, 2 and 3 will not pop out the keyboard.

When PSB1 is set to OFF and PSB0 is set to ON, the keyboard will jump out under PSW0. After input, press ENT, the keyboard will automatically jump to the bottom of PSW1. After input, press ENT to complete the input of PSW0 and PSW1; Similarly, when PSB0 is set to OFF, PSW2 and PSW3 are input when PSB1 is set to ON.

When PSB0 and PSB1 are both set to ON, the input program will be triggered in the order of PSW0, PSW2, PSW1 and PSW3. Click ESC to cancel the input.



1. The keyboard pops up when the control coil is set to ON. After input, the control coil (PSB0, PSB1) will not reset automatically. If you want to re-enter data, please manually reset and trigger again.

2. It is recommended that the control coil be set to reverse state. If it is set to instantaneous ON, take PSW0 and PSW1 above as an example. If PSB0 is set to instantaneous ON, a keyboard will pop up below PSW0 at the same time of triggering. Click ENT after input, and the keyboard will disappear. Only PSW0 can be input. Even if it is triggered again, the keyboard will only be displayed below PSW0, and the setting of PSW1 cannot be completed.

Action

Set on
 Set off
 Reverse
 Instantaneous on

Keyboard setting

Set whether to pop up the keyboard, keyboard style selection, and keyboard pop-up position

■ Notice

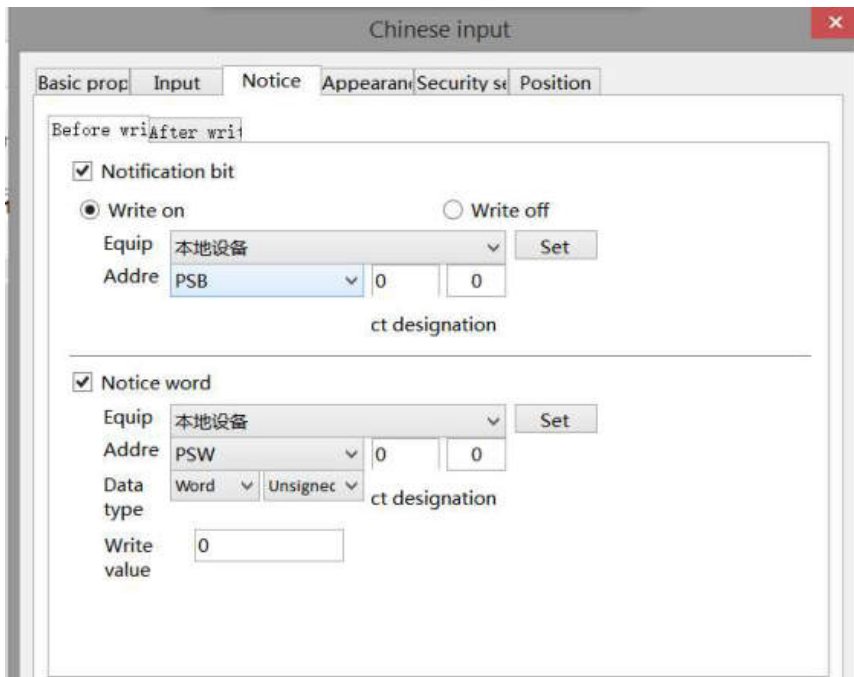

Notice

If Enabled, you can choose to write the target coil ON, OFF or the target register to a constant (notification word) before or after writing.

■ Appearance

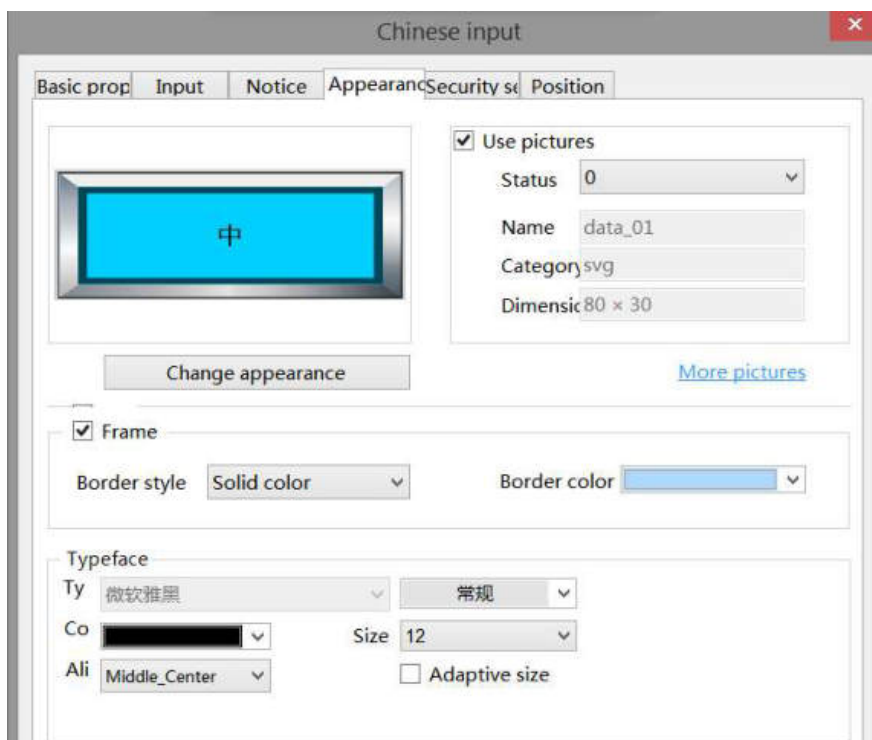

Same to chapter 4-2-3 numeric input appearance part.



The font for Chinese input can only be Microsoft Yahei by default, and no other font can be

set.

- Security setting

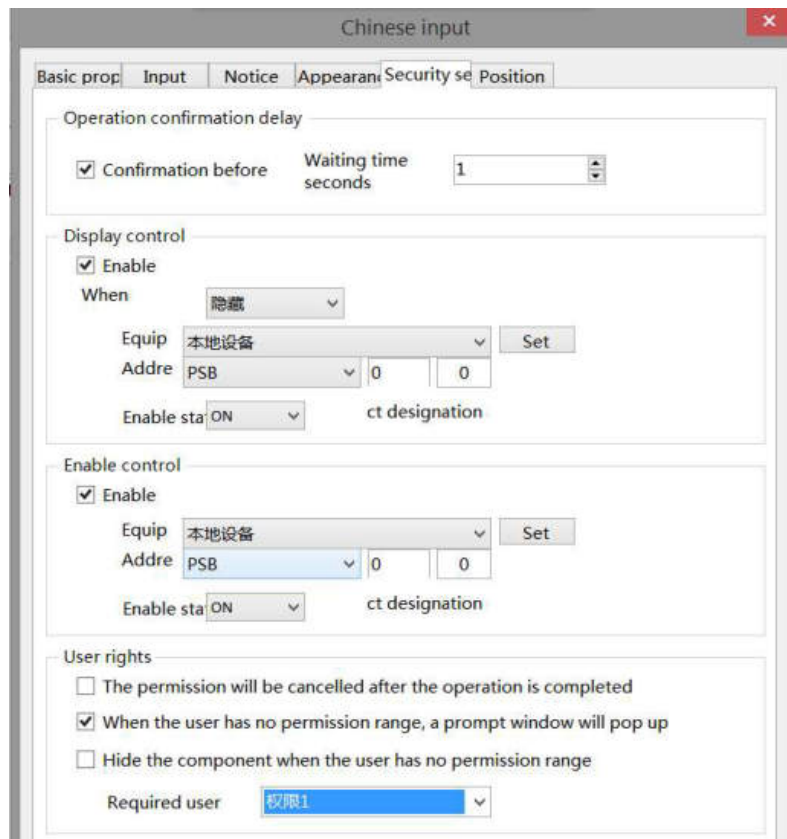

Same to chapter 4-2-3 numeric input security setting part.

- Position

Same to chapter 4-1-1 straight line position part.

4-2-8. Chinese display

1. Click "Parts/Display/Chinese Display" in the menu bar or  icon in the basic part bar of the control window, move the cursor to the screen, click the left mouse button to place it, click the right mouse button or click ESC to cancel the placement. Modify the length and width of the border through the border points.
2. When setting attributes, you can set them in the attribute box that pops up when placing components, or you can double-click "Chinese Display" or select "Chinese Display" and right-click to select Attributes.

- Basic property

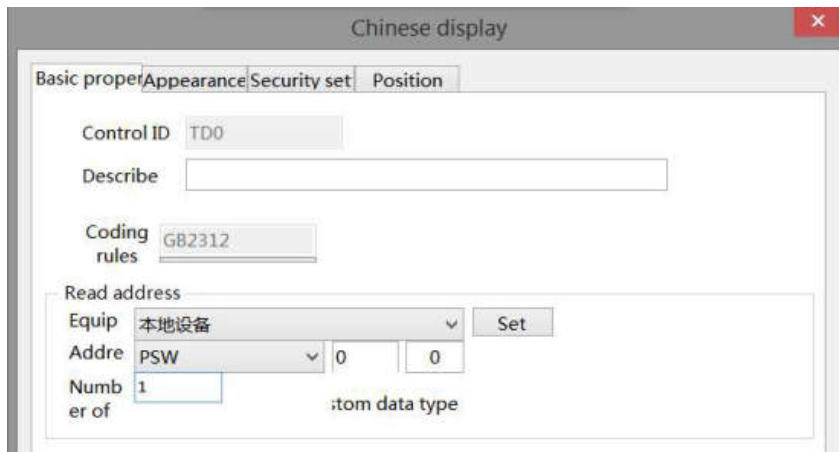

Control ID	It is used for system management control and cannot be operated by users
Describe	Can be used to comment on the purpose of this component
Coding rules	You can choose from three encoding rules: GB2312, UTF-8, and Unicode.
Read address	Set the read address
Equipment	Current equipment port for communication
Address	Set target register number
Register number	Set the character input length. One register can display two characters
Custom data type	The default is Word. If checked, it can be customized as DWord or DDWord
Set	Click "Set" to enter the address setting interface, which can also be used to set system registers. Address tag library is not supported for Chinese input/Chinese display

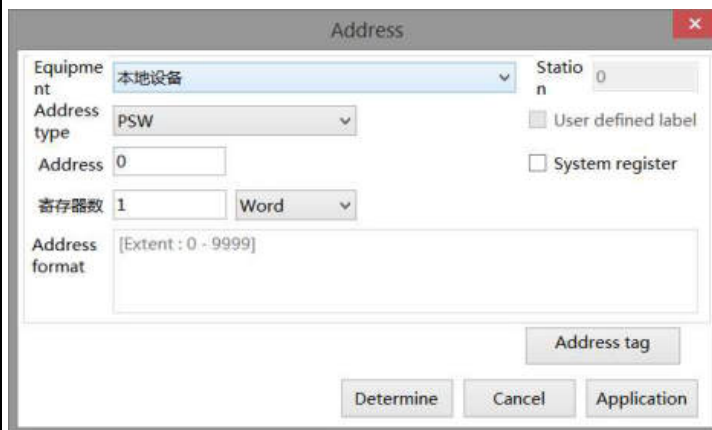

■ Appearance

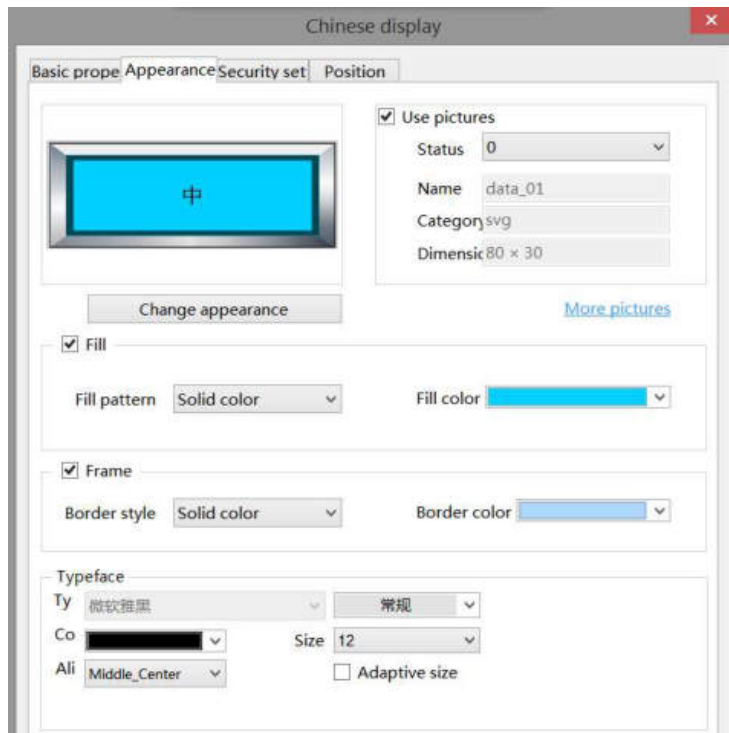

Same to chapter 4-2-3 numeric input appearance part.



The font displayed in Chinese can only be Microsoft Yahei by default, and no other font can be set.

■ Security setting

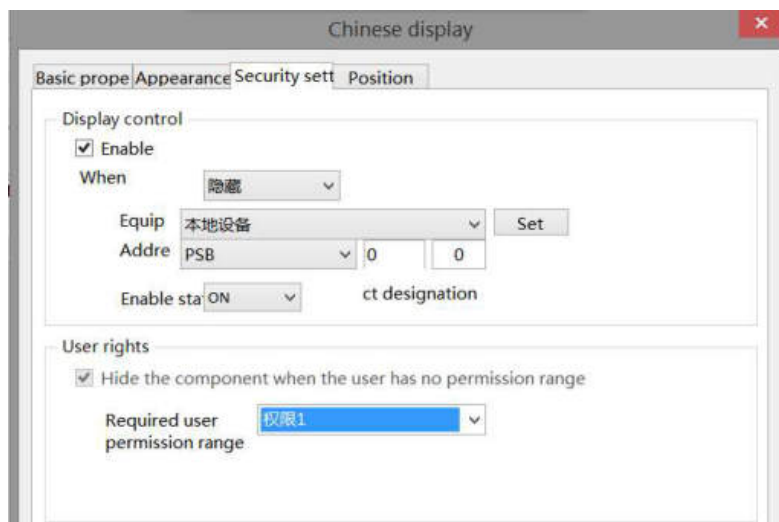

Same to chapter 4-1-1 straight line security setting part.

■ Position

Same to chapter 4-1-1 straight line position part.

4-2-9. Indicator light

Displays the status of the specified coil.

1. Click the "Parts/Key/Indicator light" in the menu bar or the  icon in the basic part bar of the control window, move the cursor to the screen, click the left mouse button to place it, click the right mouse button or click ESC to cancel it. Modify the length and width of the control through the boundary point.
2. When setting attributes, you can set them in the attribute box that pops up when you place components, or you can double-click the Indicator light or select the Indicator light and right-click to set attributes.

■ Basic property

Control ID	It is used for system management control and cannot be operated by users
Describe	Can be used to comment on the purpose of this component
Read address	Set the read address
Equipment	Current equipment port for communication
Set	Click "Set" to enter the address setting interface, where you can set and use system registers and user-defined tags. You can click the address tag library below or the project tree - library - address tag library to set the tags used (see chapter 5-2 Address Tag Library for the use of address tag library and user-defined tags)
Address	Set the target coil number
Indirect assignment	Set the current address offset. The current coil address changes with the indirectly specified register value, that is, $Dx [Dy]=D [x+Dy \text{ value}]$ ($x, y=0, 1, 2, 3\dots$). For example, the current

	coil address is PSB0, if the indirectly assigned address is PSW100; When the value of PSW100 register is 0, the coil controlling this element is still PSB0; When the value of PSW100 register is 1, the coil controlling this element is PSB1 (and so on)
Logic	Select positive logic or negative logic (positive logic: coil is on in ON state, coil is off in OFF state; negative logic: coil is off in ON state, coil is on in OFF state)
Twinkle	Select whether to flash, including ON status flashing, OFF status flashing and flashing frequency setting

■ Appearance

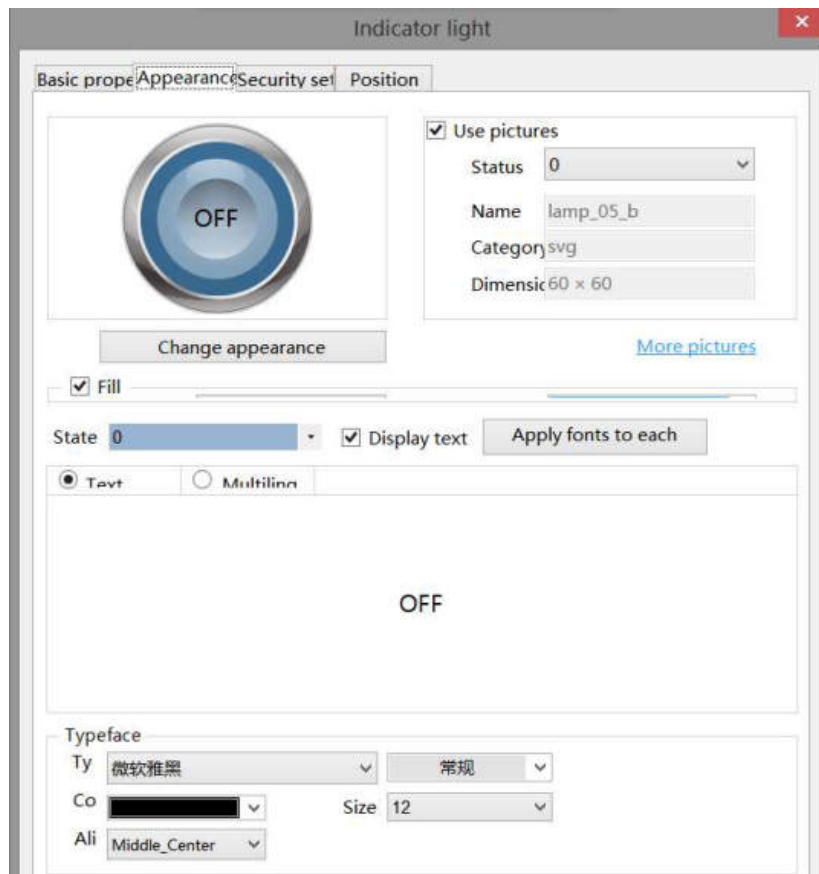

Appearance	You can check whether to use pictures. If you check, you can set the appearance of the indicator in the (0, 1) two states. After selecting the state in the upper right corner, click "Change Appearance" or click "More Pictures" to select a custom picture to change the appearance
Fill	Fill style and color can be set
State	You need to check "Display Text" to set the text prompt content of the indicator in the (0, 1) two states, and you can set whether to use multiple languages (see chapter 4-7 for the specific use of multiple language libraries). Check the drop-down list to set the font corresponding to the corresponding status of the indicator light, or click the "apply fonts to each status" button to set the fonts in all statuses
Typeface	You can set the font, size, font style, color and the display position of the font in the component (you can also check the adaptive size, that is, drag the mouse to change the size of the component, and the text size will change accordingly)

■ Security setting

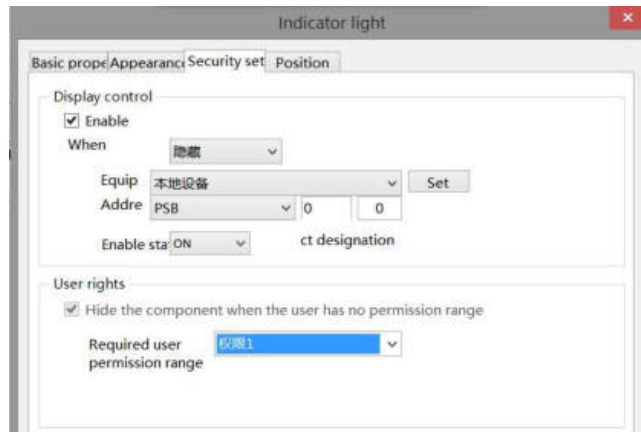

Same to chapter 4-1-1 straight line security setting part.

■ Position

Same to chapter 4-1-1 straight line position part.

4-2-10. Indicator button

Control the status of the specified coil and display the status of the specified coil.

1. Click "Parts/Key/Indicator Button" in the menu bar or  in the basic part bar of the control window, move the cursor to the screen, click the left mouse button to place it, click the right mouse button or click ESC to cancel the placement. Modify the length and width of the control through the boundary point.
2. When setting attributes, you can set them in the attribute box that pops up when placing components. You can also double-click the "Indicator Button" or select the "Indicator Button" and then right-click to select Attribute.

■ Basic property

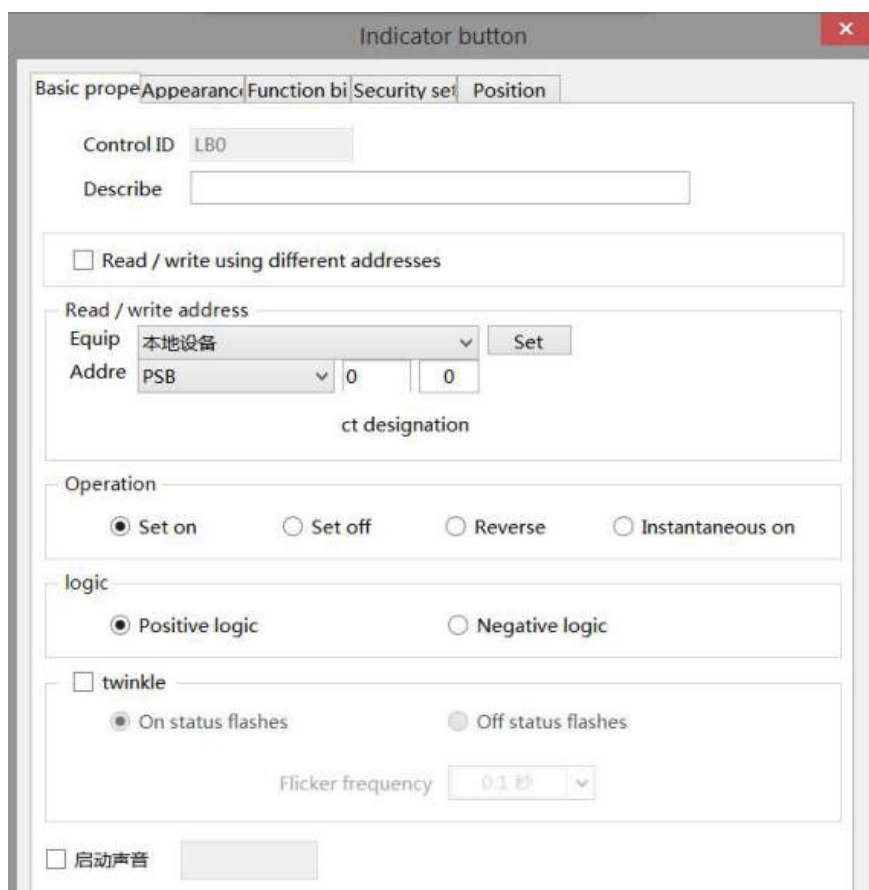

Control ID	It is used for system management control and cannot be operated by users
Describe	Can be used to comment on the purpose of this component
Read/write using different addresses	If not checked, the same address is used for reading and writing (refer to chapter 4-2-3 description of reading/writing address for numerical input)
Read address	Set the displayed address; You can also set whether there is an offset (that is, indirect assignment)
Write address	Set the write in address; You can also set whether there is an offset (that is, indirect assignment)
Equipment	Current equipment port for communication
Address	Set the target coil number
Set	Click "Set" to enter the address setting interface, where you can set and use system registers and user-defined tags. You can click the address tag library below or the project tree – library - address tag library to set the tags (see chapter 5-2 Address Tag Library for the use of address tag library and user-defined tags)

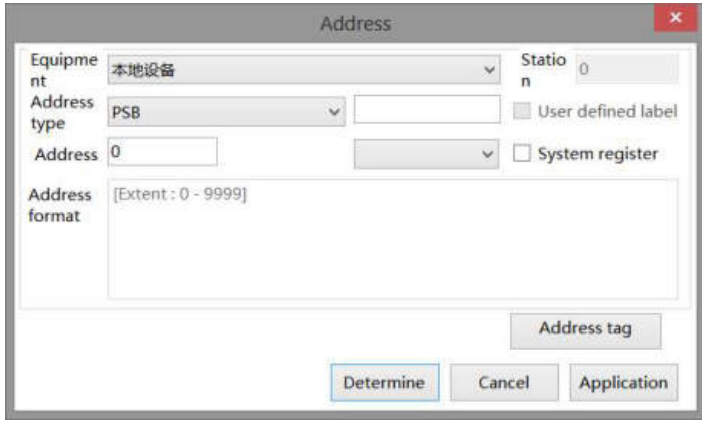
		
Indirect assignment		Set the current address offset. The current coil address changes with the indirectly specified register value, that is, Dx [Dy]=D [x+Dy value] (x, y=0, 1, 2, 3...). For example, the current coil address is PSB0, if the indirectly assigned address is PSW100; When the value of PSW100 register is 0, the coil controlling this element is still PSB0; When the value of PSW100 register is 1, the coil controlling this element is PSB1 (and so on)
Operation	Set ON	Set the control coil to logic 1 state
	Set OFF	Set the control coil to logic 0 state
	Reverse	Set the control coil to the opposite state
	Instantaneous ON	When the key is pressed, the coil is in logic 1 state, and when the key is released, the coil is in logic 0 state
Logic		Select positive logic or negative logic (positive logic: coil is on in ON state, coil is off in OFF state; negative logic: coil is off in ON state, coil is on in OFF state)
Twinkle		Select whether to flash, including ON status flashing, OFF status flashing and flashing frequency setting
Enable audio		When the trigger conditions are met, the customized audio can be played. At present, this function is only available in the TS5L series. For specific usage, see chapter 5-4 Use of Audio Resource Library

■ Appearance

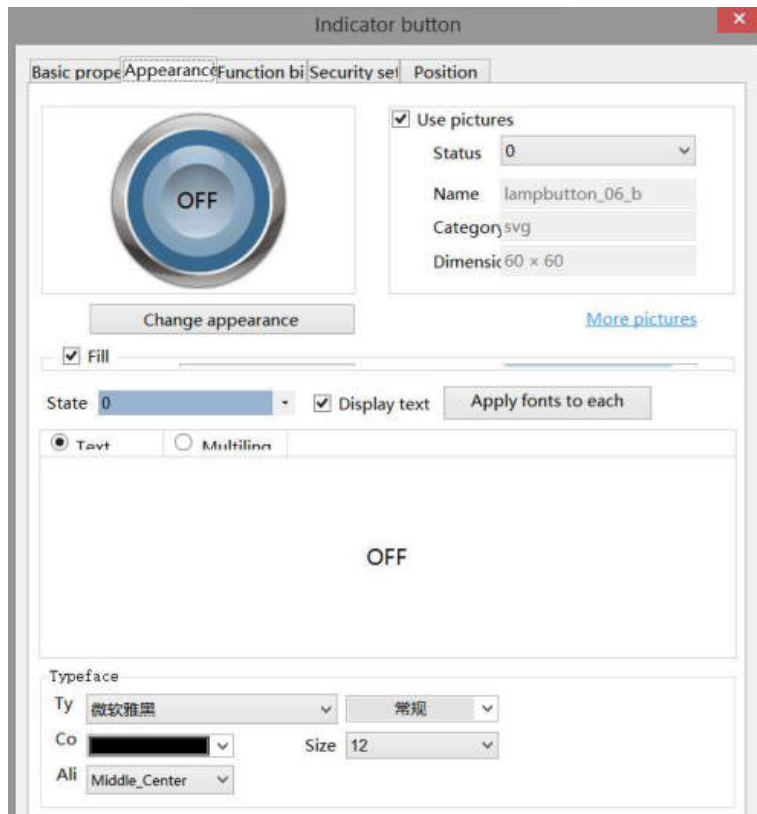

Appearance	You can check whether to use pictures. If you check, you can set the appearance of the indicator in the (0, 1) two states. After selecting the state in the upper right corner, click "Change Appearance" or click "More Pictures" to select a custom picture to change the appearance
Fill	Fill style (solid/gradient) and fill color can be set
State	You need to check "Display Text" to set the text prompt content of the indicator in the (0, 1) two states, and you can set whether to use multiple languages (see chapter 4-7 for the specific use of multiple language libraries); Check the drop-down list to set the font corresponding to the corresponding status of the indicator light, or click the "apply fonts to each status" button to set the fonts in all statuses
Typeface	You can set the font, size, font style, color and the display position of the font in the component

■ Function binding

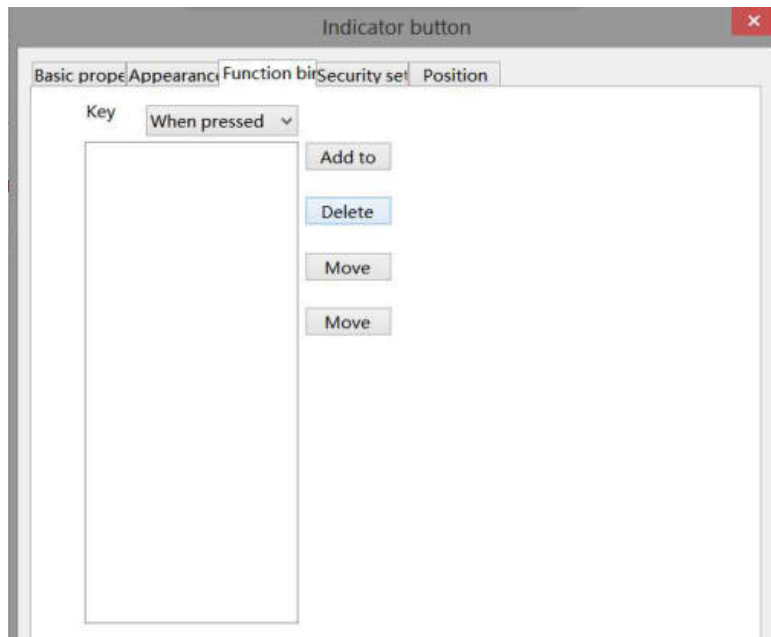

Calling the C function can complete more and more complex operations and communications. Function use is equivalent to chapter 4-2-15 item (10) function key - function call.

Key operation		Set the operation mode, including pressing and releasing
Function item	Add to	Add function
	Delete	Delete the function
	Move up	Move the target function up one physical location
	Move down	Move the target function down one physical location

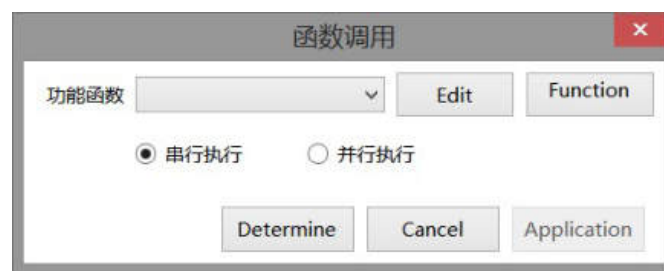

Function	Select the function to be called from the drop-down menu
Edit/Function	Click to enter the function editing page
Serial execution	The task calling this function can only continue the subsequent processing after the function is executed. Therefore, this function must have appropriate exit conditions
Parallel execution	Call the task of this function, create a new task to execute the function, and the caller will continue the subsequent processing

■ Security setting

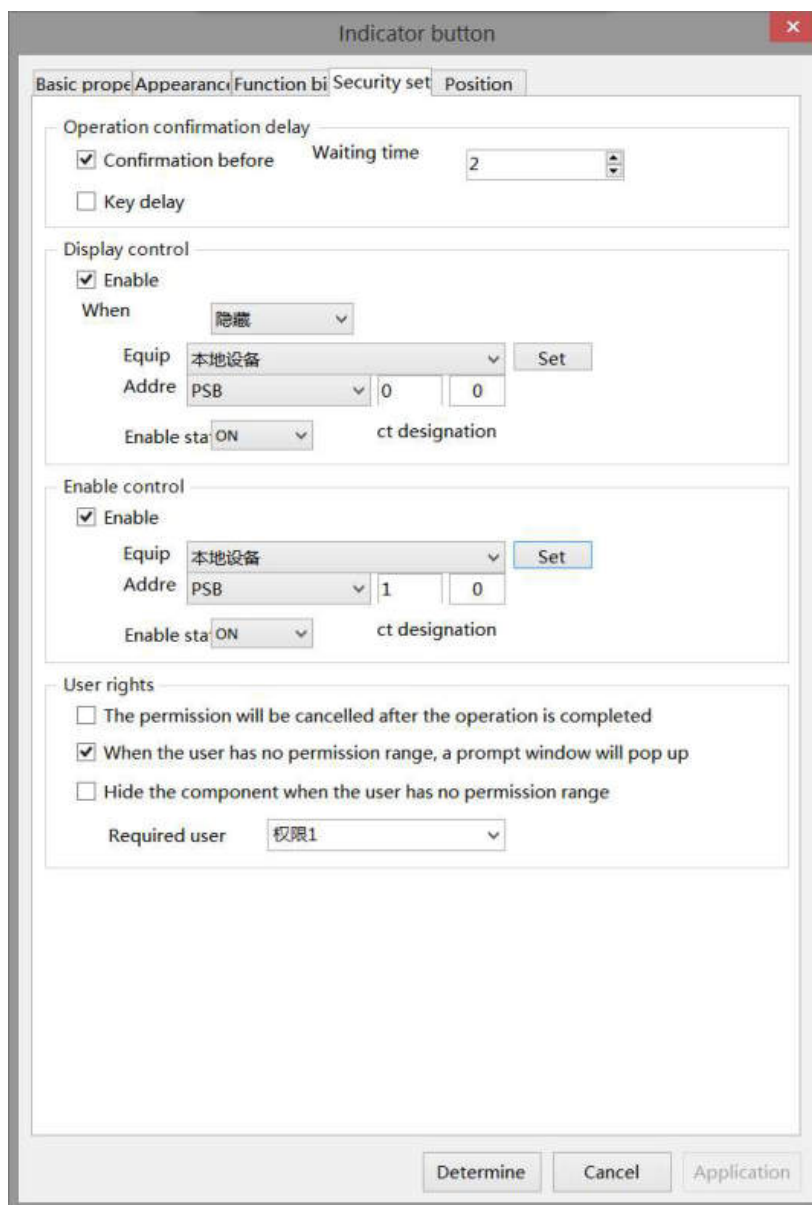

Operation confirmation delay	The waiting time (s) can be set. If this option is checked, a pop-up window "Are you sure to execute this operation" will pop up when operating components. If you do not click "Confirm" or "Cancel" within the set waiting time, the pop-up window will disappear by itself and this operation will fail. If you click "OK" within the waiting time, the operation is successful. If you click "Cancel", the operation is invalid.
Key delay	The operation will not take effect until the set delay time is long pressed
Display control	Use bits to control whether to display the component. When the condition is not met, the component will be hidden
Enable	When checked, display control will be enabled
When validation fails	Set the display of the component when validation fails
Address	Set the target coil for bit control
Enable status	Set ON status to be valid or OFF status to be valid. For example, if the equipment is checked as shown in the figure above, the bit control is PSB0, and it is hidden when the verification fails, and the enabling status is ON, then the component will be displayed normally when the status of PSB0 is ON, and it will not be displayed when the status of PSB0 is OFF

Enable control	The bit limit can be set (the enabling state of the enable control can be customized). When the enabling conditions are met, the component can be used normally (as shown in the figure above: when the PSB1 is in the ON state and the trigger conditions are met at the same time, the component can be used; if the PSB1 is in the OFF state, the component is still unavailable even if the trigger conditions are met)
User rights	<p>Set the controlled authority level.</p> <p>After setting the permission range of the required user, the following three functions can be checked as required:</p> <p>(1) Cancel the permission after the operation: if this option is not checked, the corresponding level password must be entered for each operation of this component. After checking, you only need to enter it successfully once</p> <p>(2) When the user has no permission range, a prompt window will pop up</p> <p>(3) When the user has no permission range, hide the component.</p>



the user rights function please refer to chapter 4-2-3 numerical input.

- Position

Same to chapter 4-1-1 straight line position part.

4-2-11. Multi-state indicator

Different states are displayed according to different values of registers.

1. Click "Part/Key/Multi state Indicator" in the menu bar or  icon in the basic part bar of the control window, move the cursor to the screen, click the left mouse button to place it, click the right mouse button or click ESC to cancel it. Modify the length and width of the control through the boundary point.
2. When setting attributes, you can set them in the attribute box that pops up when placing components. You can also double-click the "Multi state Indicator" or select the "Multi state Indicator", right-click and select Attribute.

- Basic properties

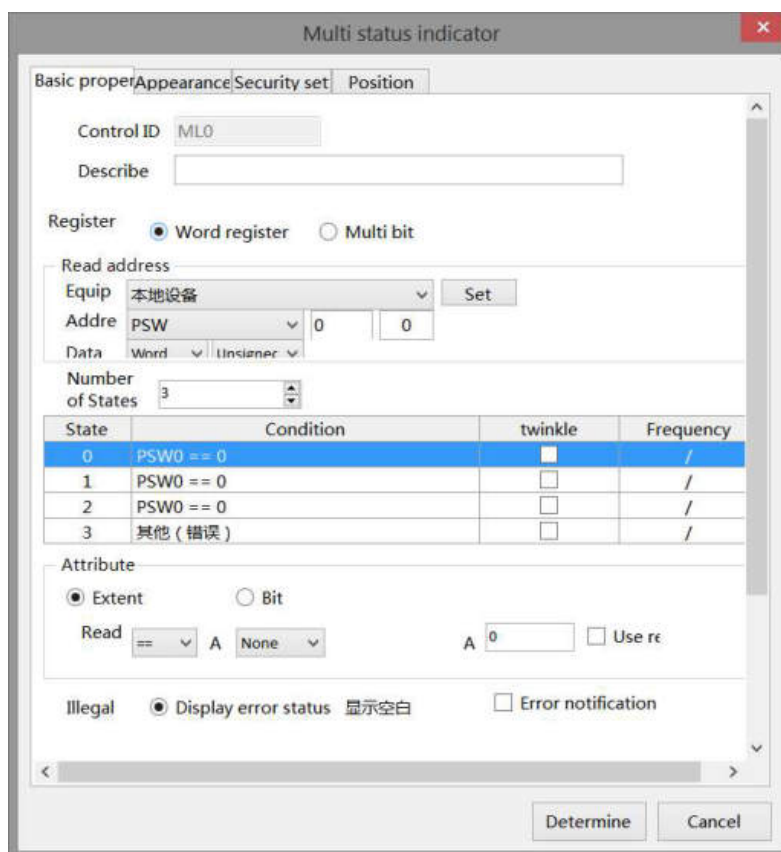

Control ID	It is used for system management control and cannot be operated by users
Describe	Can be used to comment on the purpose of this component
Register	The word register or multi bit can be selected, and the status of the status number will be displayed if the condition of the status number is met Word register: display different states according to different values of the set register. Multi bit: different states are displayed according to different values of registers formed by coils
Read address	Set the read address
Equipment	Current equipment port for communication
Address	Set target register number or coil number
Data type	Byte-8Bit; Word-16Bit; DWord- 32Bit; DDWord -64Bit; BCD format; Hex; Signed value; Unsigned value; Floating number
Set	Click "Set" to enter the address setting interface, where you can set and use system registers and user-defined tags. You can click the address tag library below or the project tree - library - address tag library to set the tags (refer to chapter 5-2 Address Tag Library for the use of address tag library and user-defined tags)

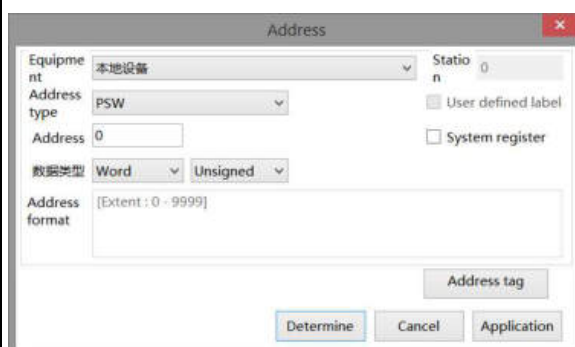

Indirect assignment	Set the current address offset. The current coil address changes with the indirectly specified register value, that is, Dx [Dy]=D [x+Dy value] (x, y=0, 1, 2, 3...). For example, the current coil address is PSB0, if the indirectly assigned address is PSW100; When the value of PSW100 register is 0, the coil controlling this element is still PSB0; When the value of PSW100 register is 1, the coil controlling this element is PSB1 (and so on)
Number of state	Set the number of statuses. The lower status display table will synchronously increase or decrease the number of statuses
State display table	After setting in the lower attribute column, you can directly observe the set status in the status display table (you cannot modify it directly on the table, but only through the lower attribute)

Attribute – word register

状态数

状态	条件	闪烁	频率
0	D0 == 1	<input checked="" type="checkbox"/>	0.1秒/次
1	D0 < 2	<input checked="" type="checkbox"/>	0.1秒/次
2	D0 <= 3	<input type="checkbox"/>	/
3	D0 < 2 And D0 > 1	<input type="checkbox"/>	/
4	D0 < 2 Or D0 > 1	<input type="checkbox"/>	/
5	其他 (错误)	<input type="checkbox"/>	/

属性

范围 位

读取值 < A None A 2 使用寄存器

闪烁 频率 0.1 秒

(1) Range: Numerical comparison method: “<”, “>”, “<=”, “>=”, “==”, “!=”;
None: only one numerical value. Such as status 0, 1, 2.
And: Both numerical judgment conditions must be met. Such as state 3.
Or: Any numerical value can be judged to meet the conditions. Such as state 4.
Blinking: When flashing is checked, the flashing frequency can be set, and the setting will be displayed in the status display table above synchronously.

(2) Bit: take PSW100 as an example.

When PSW100.0 is ON, PSW100 flashes at a frequency of 0.1 seconds per time and the font display status is 0.

When PSW100.1 is ON, PSW100 font display status 1.

	<p>When PSW100.2 is ON, PSW100 flashes at the frequency of 1 second/time and the font display status is 2.</p> <p>When PSW100.3 is OFF, PSW100 font displays status 3.</p> <p>When PSW100.4 is OFF, PSW100 flashes at the frequency of 2 seconds/time and the font display status is 4.</p> <p>If the status of PSW100.0-PSW100.4 is inconsistent with the set conditions, PSW100 font will display error status.</p>
Attribute – Multi bit	<p>The comparison method of word register is to directly read the internal value of the register to determine whether the conditions are met. However, the value of the register cannot be directly read by the combination of multi bit. The value of the register is represented by the combination of multiple coils. The following describes how the multi bit combination represents the value of the register</p>  <p>As shown in the figure above, the number of digits set is 4. The coil states of M0, M1, M2 and M3 represent different values. The minimum number is 0 and the maximum number is 15.</p> <ol style="list-style-type: none"> (1) When M0 is on and others are off, it represents the value 1 (2) When M1 is on and others are off, it represents the value 2 (3) When M2 is on and others are off, it represents the value 4 (4) When M3 is on and others are off, it represents the value 8 (5) When all are off, it represents the value 0 (6) When it is fully lit, it represents the value 15 <p>And so on</p>
Illegal input	<p>When the value of the register does not meet any of the set states, the checked state (error state or current state) will be displayed, and the error notification can be selected (the set coil light will be on when illegal input occurs)</p>



If the conditions meet multiple settings at the same time, the top status will prevail.

- Appearance

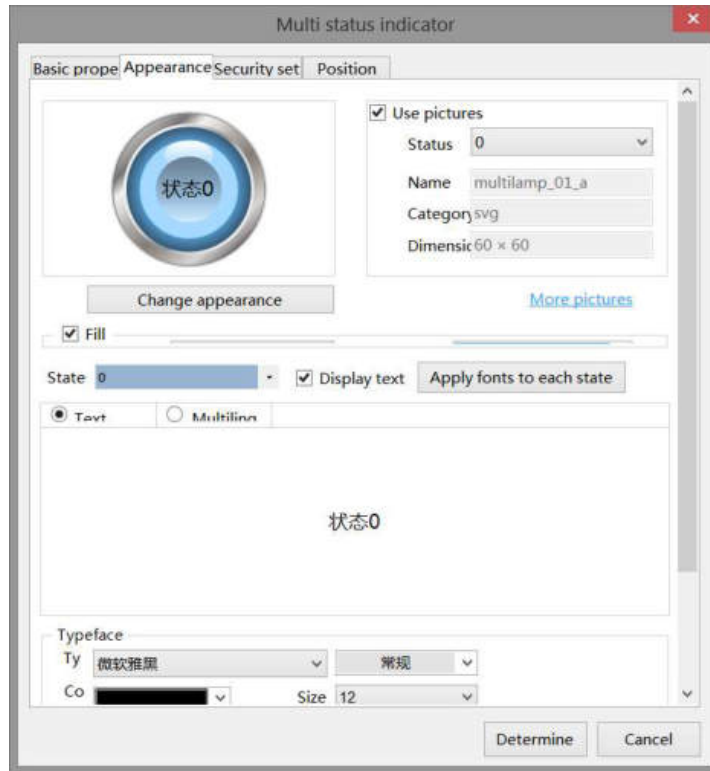

Appearance	You can check whether to use pictures. If you check, you can set the appearance of the multi state indicator in multiple states. After selecting the state in the upper right corner, click "change appearance" or click "more pictures" to select a custom picture to change the appearance
Fill	Fill style (solid/gradient) and fill color can be set
Status	You need to check "Display Text" to set the text prompt content of the multi status indicator in different states, and you can set whether to use multiple languages (refer to chapter 5-1 Label Multiple Languages for the specific use of multiple language libraries). Tick the drop-down list to set the font corresponding to the corresponding status of the multi status indicator, or click the "apply fonts to each status" button to set the font of all statuses
Typeface	The font, size, color and alignment can be set (the display position of the font in the component)



The appearance states have pictures for 3 states and 1 error state by default. When there are more than 4 states, you need to manually add the appearance in different states in the gallery.

- Security setting

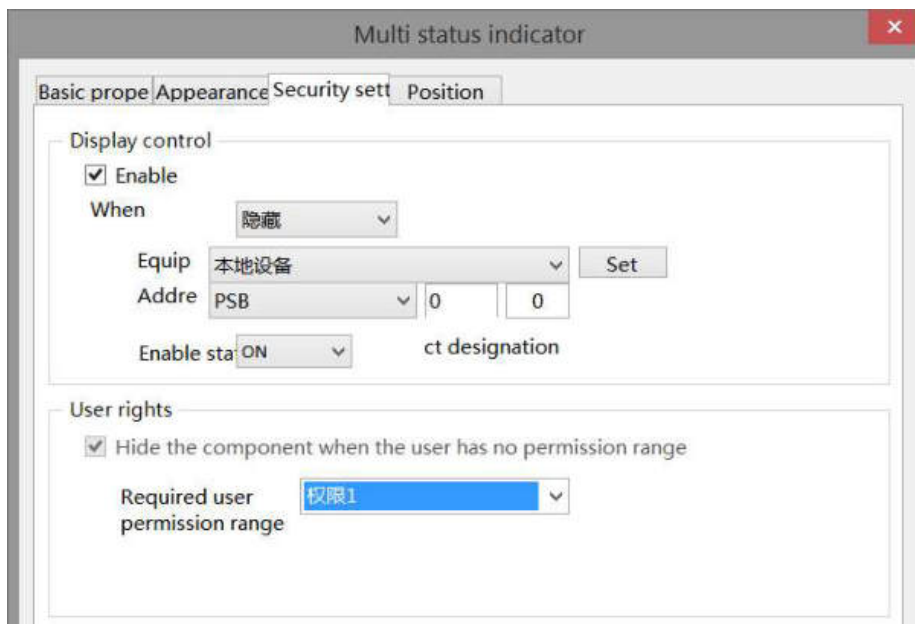

Same to chapter 4-1-1 straight line security setting part.

■ Position

Same to chapter 4-1-1 straight line position part.

4-2-12. Key

Controls the status of the specified coil.

1. Click the "Part/Key/Key" in the menu bar or the  icon in the basic part bar of the control window, move the cursor to the screen, click the left mouse button to place it, click the right mouse button or click ESC to cancel the placement. Modify the length and width of the component through the boundary point.
2. When setting attributes, you can set them in the attribute box that pops up when placing components, or you can double-click the "key" or select the "key" and right-click to select attribute.

■ Basic property

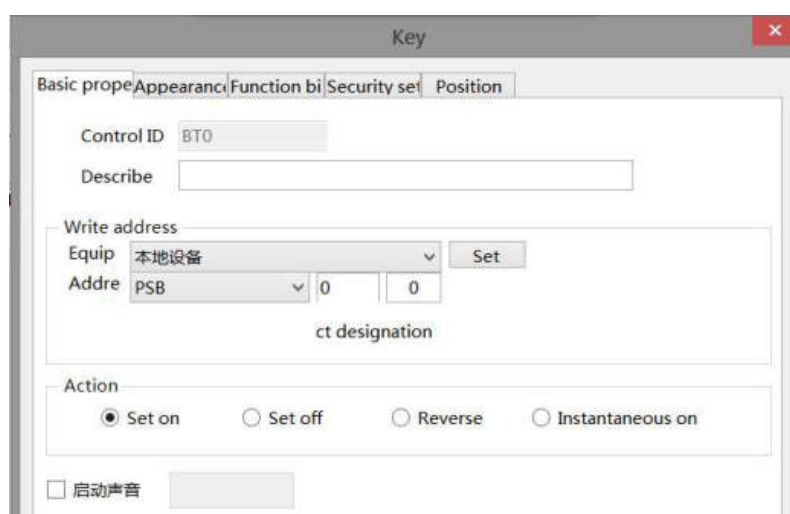

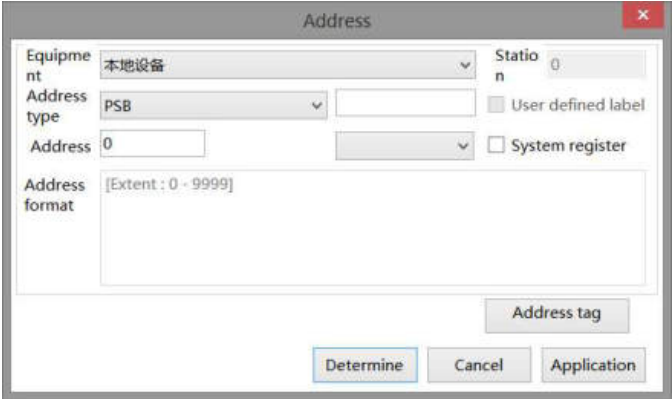
Control ID	It is used for system management control and cannot be operated by users	
Describe	Can be used to comment on the purpose of this control	
Write address	Set the write in address	
Equipment	Current equipment port for communication	
Address	Set the target coil number	
Set	<p>Click "Set" to enter the address setting interface, where you can set and use system registers and user-defined tags. You can click the address tag library below or the project tree - library - address tag library to set the tags (see chapter 5-2 Address Tag Library for the use of address tag library and user-defined tags)</p> 	
Indirect assignment	Set the current address offset. The current coil address changes with the indirectly specified register value, that is, $Dx [Dy]=D [x+Dy \text{ value}]$ ($x, y=0, 1, 2, 3\dots$). For example, the current coil address is PSB0, if the indirectly assigned address is PSW100; When the value of PSW100 register is 0, the coil controlling this element is still PSB0; When the value of PSW100 register is 1, the coil controlling this element is PSB1 (and so on)	
Action	Set ON	Set the control coil to logic 1 state
	Set OFF	Set the control coil to logic 0 state
	Reverse	Set the control coil to the opposite state
	Instantaneous ON	When the key is pressed, the coil is in logic 1 state, and when the key is released, the coil is in logic 0 state
Enable audio	When the trigger conditions are met, the customized audio can be played. At present, this function is only available in the TS5L series. For specific usage, see chapter 5-4 Use of Audio Resource Library	

■ Appearance

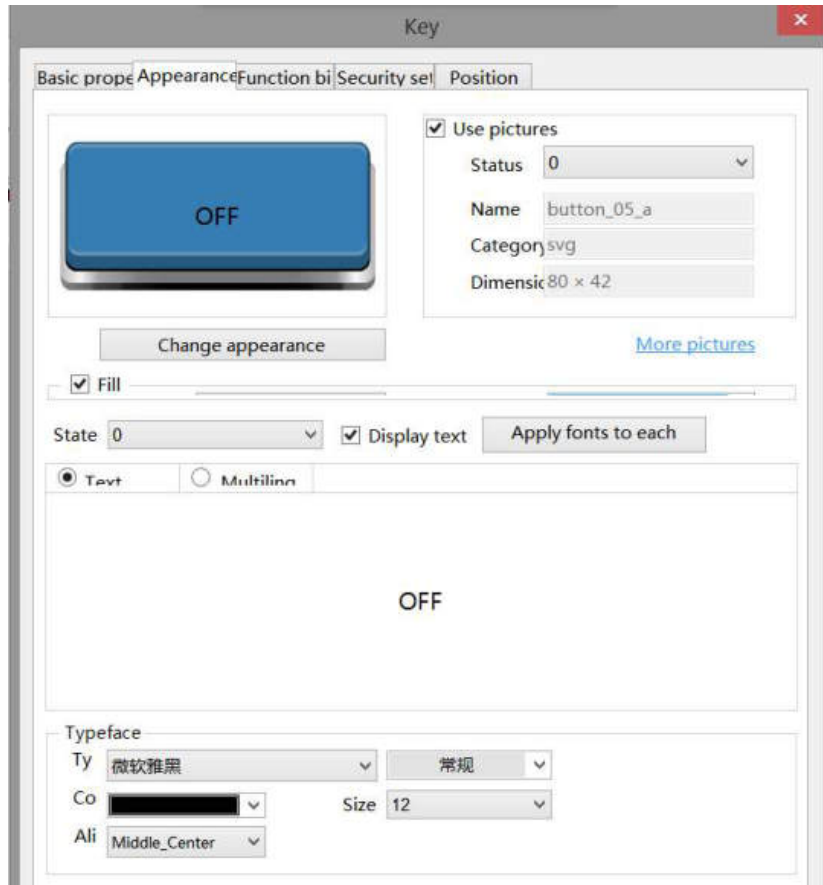

Appearance	You can check whether to use pictures. If you check, you can set the appearance of the key in the (0, 1) two states. After selecting the state in the upper right corner, click "Change Appearance" or click "More Pictures" to select a custom picture to change the appearance
Fill	Fill style (solid/gradient) and fill color can be set
State	You need to check "Display Text" to set the text prompt content when the key is in the (0, 1) two states, and you can set whether to use multiple languages (see chapter 5-1 Label Multiple Languages for the specific use of multiple language libraries). Tick the drop-down list to set the font corresponding to the corresponding state of the button, or click the "apply fonts to each state" button to set the font in all states
Typeface	You can set the font, size, color and display position of the font in the component

■ Function binding

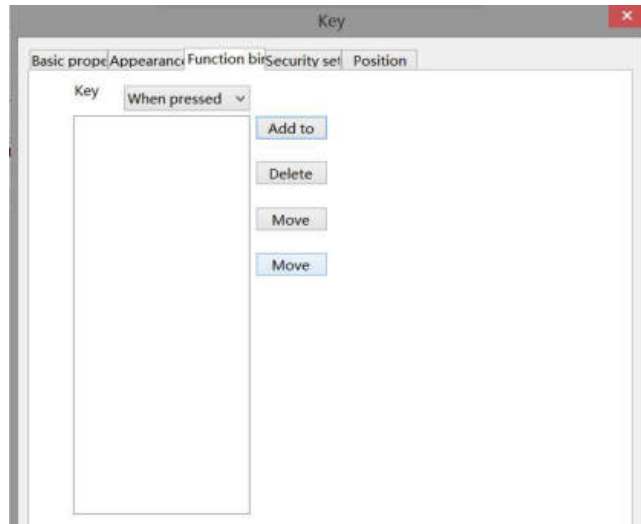

Same to chapter 4-2-10 indicator button.

■ Security setting

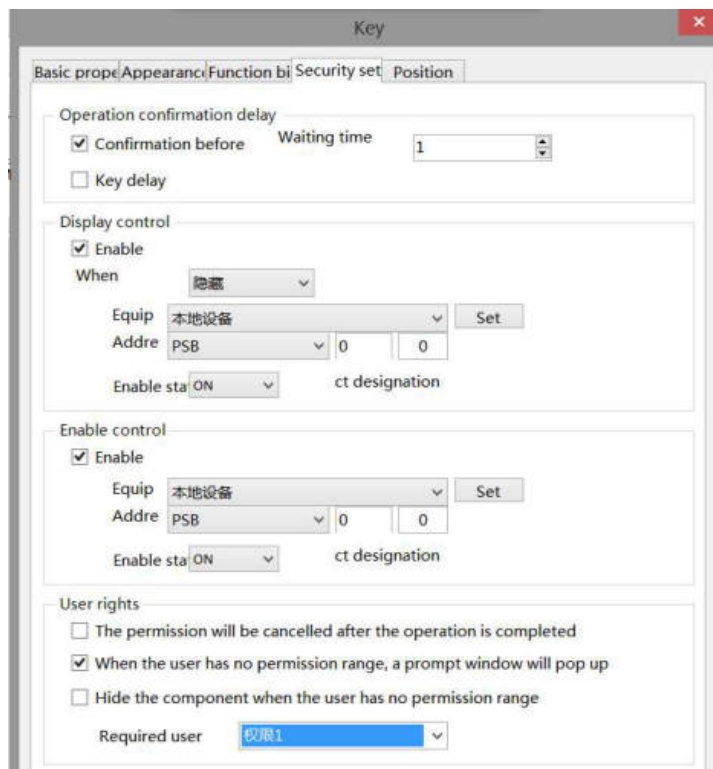

Same to chapter 4-2-10 indicator button security setting part.

■ Position

Same to chapter 4-1-1 straight line position part.

4-2-13. Multi state key

Pressing this component can control the status of different coils or set different values for registers.

1. Click "Part/Key/Multi state Key" in the menu bar or  in the basic part bar of the control window, move the cursor to the screen, click the left mouse button to place it, click the right mouse button or click ESC to cancel it. Modify the length and width of the control through the boundary point.
2. When setting attributes, you can set them in the attribute box that pops up when placing components. You can also double-click the "Multi state key" or select the "Multi state key" and right-click to select Attribute.

- Basic property

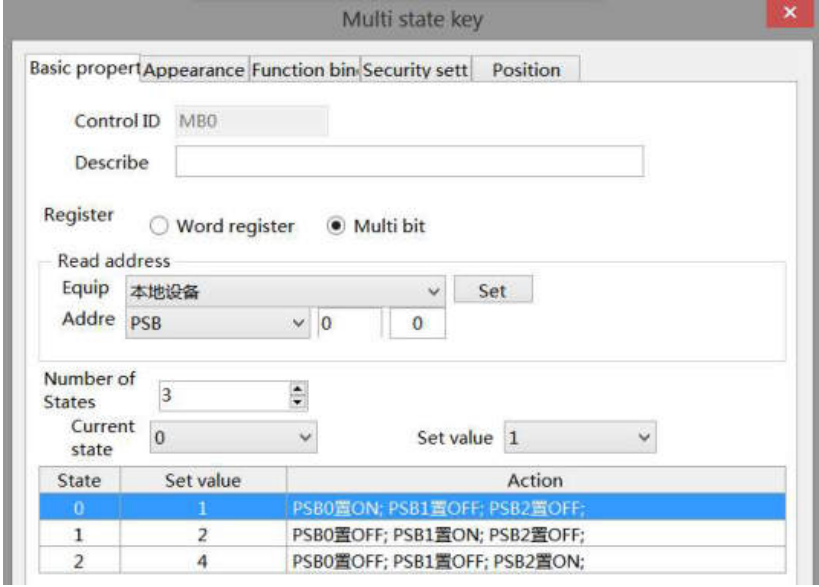

State	Set value	Action
0	1	PSB0置ON; PSB1置OFF; PSB2置OFF;
1	2	PSB0置OFF; PSB1置ON; PSB2置OFF;
2	4	PSB0置OFF; PSB1置OFF; PSB2置ON;

Control ID	It is used for system management control and cannot be operated by users
Describe	Can be used to comment on the purpose of this component
Register	Multi bit or word register can be selected
Multi bit	The status of the coil in different states can be set (as shown in the figure above, when the number of bits is set to 3, the number of states is at most $2^3=8$. You can pull down the current state to set the value in each state, and the value represented by the lighting of PSB0, PSB1, and PSB2 coils will be automatically generated under the action bar)
Equipment	Current equipment port for communication
Address	Set the target coil address
Indirect assignment	Set the current address offset. The current coil address changes with the indirectly specified register value, that is, $Dx [Dy]=D [x+Dy \text{ value}]$ ($x, y=0, 1, 2, 3\dots$). For example, the current coil address is PSB0, if the indirectly assigned address is PSW100; When the value of PSW100 register is 0, the coil controlling this element is still PSB0; When the value of PSW100 register is 1, the coil controlling this element is PSB1 (and so on)
Set	Click "Set" to enter the address setting interface, where you can set and use system registers and user-defined tags. You can click the address tag library below or the project tree - library - address tag library to set the tags used (see chapter 5-2 Address Tag Library for the use of address tag library and user-defined tags)

Word register

The register value in different states can be set (as shown in the figure below, the current state can be pulled down to set the value in each state. When the state is 0, the value of PSW0 is 1; when the state is 1, the value of PSW0 is 2; when the state is 2, the value of PSW0 is 4)

State	Set value	Action
0	1	PSW0置1
1	2	PSW0置2
2	4	PSW0置4

■ Appearance

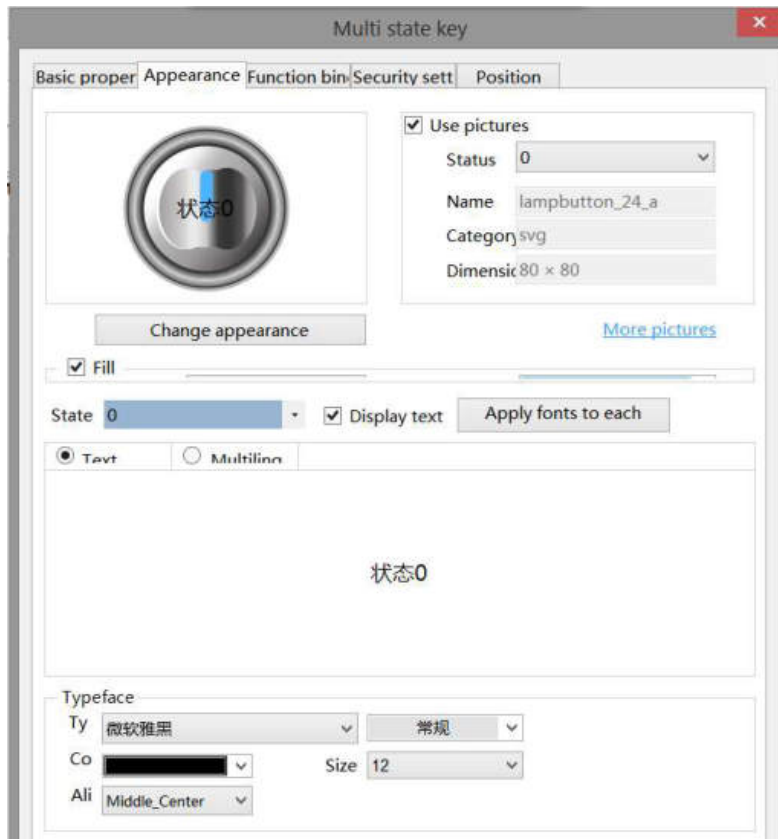

Appearance	You can check whether to use pictures. If you check, you can set the appearance of the multi state key in different states. After selecting the state in the upper right corner, click "Change appearance" or click "More pictures" to select a custom picture to change the appearance
Fill	Fill style (solid/gradient) and fill color can be set
State	You need to check "Display Text" to set the text prompt content of the multi status key in different states, and you can set whether to use multiple languages
Typeface	You can set the font, font style, size, font style, color and the display position of the font in the component

■ Function binding

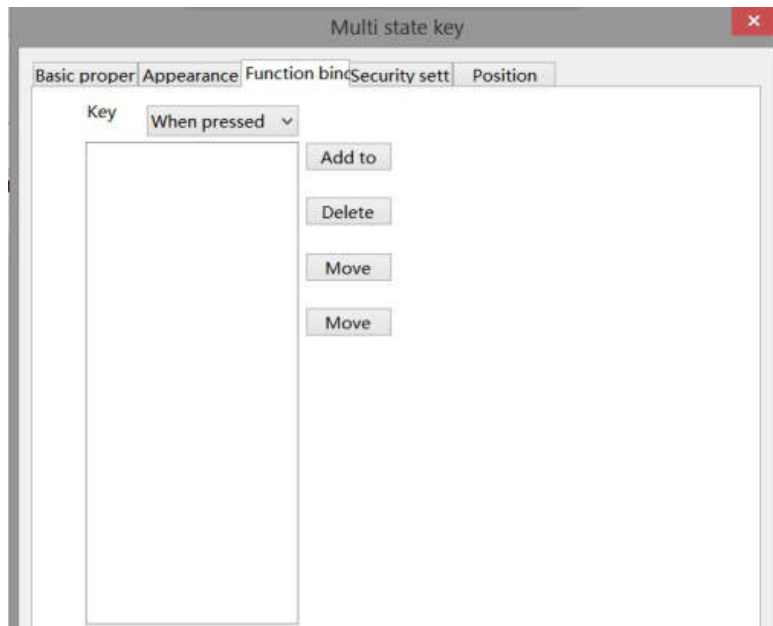

Same to chapter 4-2-10 indicator button.

■ Security setting

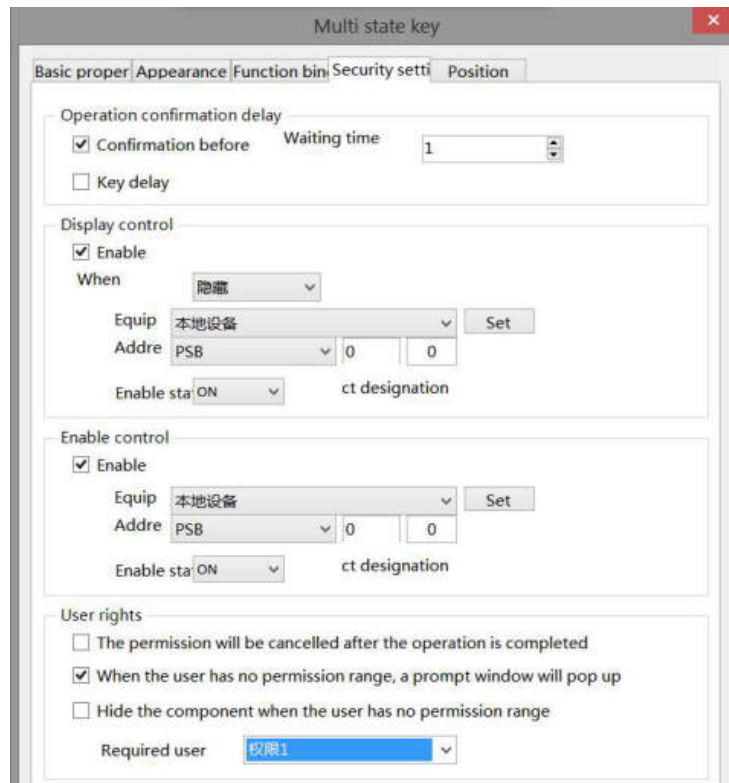

Same to chapter 4-2-10 indicator button security setting part.

■ Position

Same to chapter 4-1-1 straight line position part.

4-2-14. Character key

1. Click the "Part/Key/Character Key" in the menu bar or the  icon in the basic part bar of the control window, move the cursor to the screen, click the left mouse button to place it, click the right mouse button or click ESC to cancel it. Modify the length and width of the control through the boundary point.
2. When setting attributes, you can set them in the attribute box that pops up when placing components. You can also double-click the "character key" or select the "character key" and then right-click to select attribute.

- Basic property



Control ID	It is used for system management control and cannot be operated by users
Describe	Can be used to comment on the purpose of this component
Keyboard entry	Enter the ASCII code corresponding to the key. The ASCII code value corresponding to the commonly used keys is shown below: 1—0X31 2—0X32 3—0X33 4—0X34 5—0X35 6—0X36 7—0X37 8—0X38 9—0X39 0—0X30 ESC—0X1B ENT—0XD
Enable audio	When the trigger conditions are met, the customized audio can be played. At present, this function is only available in the TS5L series. For specific usage, see chapter 5-4 Use of Audio Resource Library

- Appearance

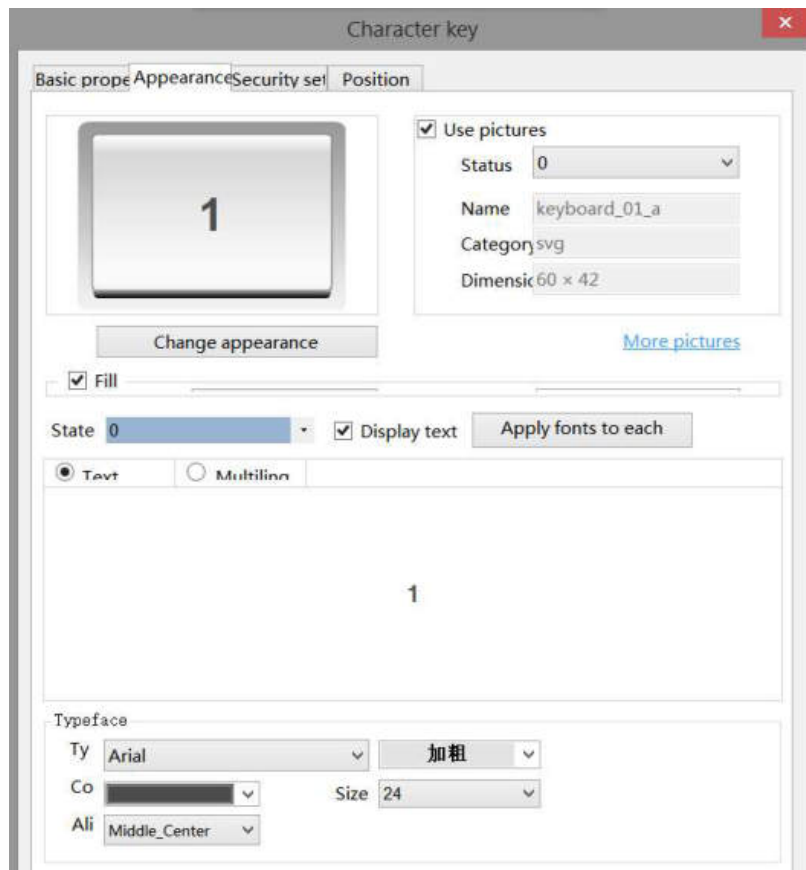

Appearance	You can check whether to use pictures. If you check, you can set the appearance of the key in the (0, 1) two states. After selecting the state in the upper right corner, click "Change Appearance" or click "More Pictures" to select a custom picture to change the appearance
Fill	Fill style (solid/gradient) and fill color can be set
State	You need to check "Display Text" to set the text prompt content when the key is in the (0, 1) two states, and you can set whether to use multiple languages (see chapter 5-1 Label Multiple Languages for the specific use of multiple language libraries). Tick the drop-down list to set the font corresponding to the corresponding state of the button, or click the "apply fonts to each state" button to set the font in all states
Typeface	You can set the font, size, color and display position of the font in the component

■ Security setting

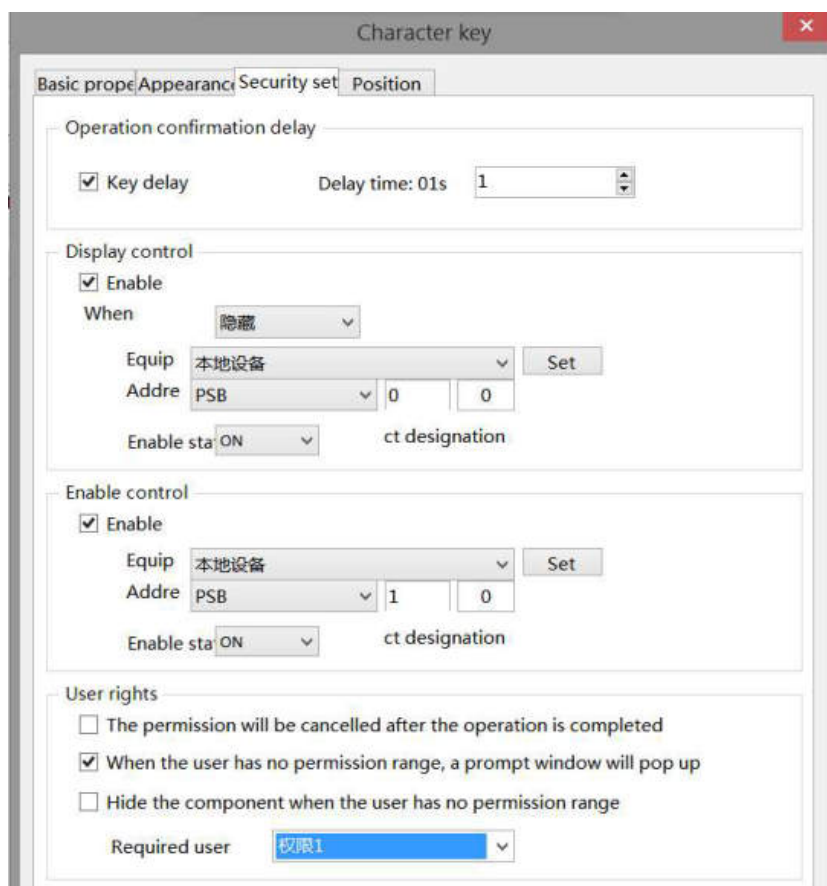

Key delay	The operation will not take effect until the set delay time is long pressed
Display control	Use bits to control whether the part is displayed. When the conditions are not met, the component is hidden. It is hidden by default and cannot be modified
Enable	When checked, display control will be enabled
When validation fails	Set the display of the component when validation fails
Address	Target coil with positioning control
Enable state	Set ON status to be valid or OFF status to be valid. For example, if the equipment is checked as shown in the figure above, the bit control is PSB0, and it is hidden when the verification fails, and the enable state is ON, then the component will be displayed normally when the status of PSB0 is ON, and it will not be displayed when the status of PSB0 is OFF.
Enable control	The bit limit can be set (the enable state of the enable control can be customized). When the enabling conditions are met, the component can be used normally (as shown in the figure above: when the PSB1 is in the ON state and the trigger conditions are met at the same time, the component can be used; if the PSB1 is in the OFF state, the component is still unavailable even if the trigger conditions are met)
User rights	Set the controlled authority level. After setting the permission range of the required user, the following three functions can be checked as required: (1) Cancel the permission after the operation: if this option is not checked, you need to enter the corresponding level password for each operation of this part. After checking, you only need

to enter it once

(2) When the user has no permission range, a prompt window will pop up

(3) When the user has no permission range, hide the component.



Refer to chapter 4-2-3 for the use of user rights function.

■ Position

Same to chapter 4-1-1 straight line position part.

4-2-15. Function key

Pressing this component can realize multiple functions at the same time.

1. Click the "Part/Key/Function Key" icon in the menu bar or the  icon in the basic part bar of the control window, move the cursor to the screen, click the left mouse button to place it, click the right mouse button or click ESC to cancel it. Modify the length and width of the control through the boundary point.

2. When setting attributes, you can set them in the attribute box that pops up when placing components, or you can double-click Function Key or select Function Key and right-click to select Attribute.

■ Function

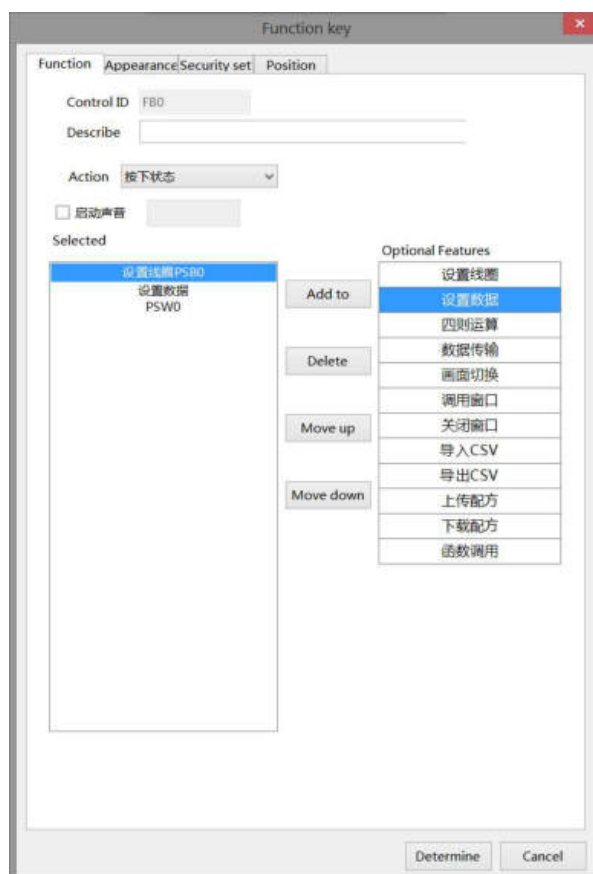

Control ID	It is used for system management control and cannot be operated by users
Describe	Can be used to comment on the purpose of this component
Action	Set the operation mode, including press state and release state
Enable audio	When the trigger conditions are met, the customized audio can be played. At present, this function is only available in the TS5L series. For specific usage, see chapter 5-4 Use of

		Audio Resource Library
Operations	Add to	Add functions
	Delete	Delete functions
	Move up	Move the target option function up for one physical location
	Move down	Move the target option function down for one physical location
Optional features		Select the corresponding function, click the "Add to" button to add the function item to the left list - Selected Functions. Double click the selected function to enter the setting window

(1) Set coil

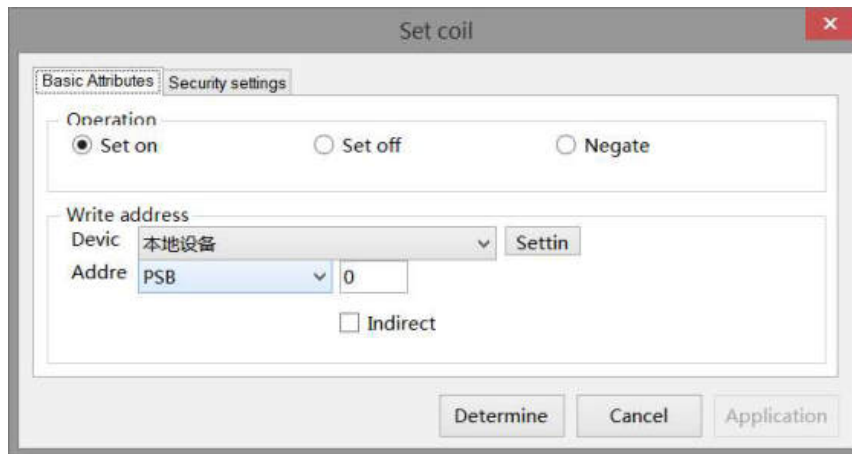

Operation	Set ON	Set the control coil to logic 1 state
	Set OFF	Set the control coil to logic 0
	Reverse	Set the control coil to the opposite state
Write address		Set the write in address
Equipment		Current equipment port for communication
Address		Set target coil address
Indirect assignment		Set the current address offset. The current coil address changes with the indirectly specified register value, that is, $Dx[Dy]=D[x+Dy \text{ value}]$ ($x, y=0, 1, 2, 3\dots$). For example, the current coil address is PSB0, if the indirectly assigned address is PSW100; When the value of PSW100 register is 0, the coil controlling this element is still PSB0; When the value of PSW100 register is 1, the coil controlling this element is PSB1 (and so on)
Set		Click "Set" to enter the address setting interface, where you can set and use system registers and user-defined tags. You can click the address tag library below or the project tree - library - address tag library to set the tags (see chapter 5-2 Address Tag Library for the use of address tag library and user-defined tags)

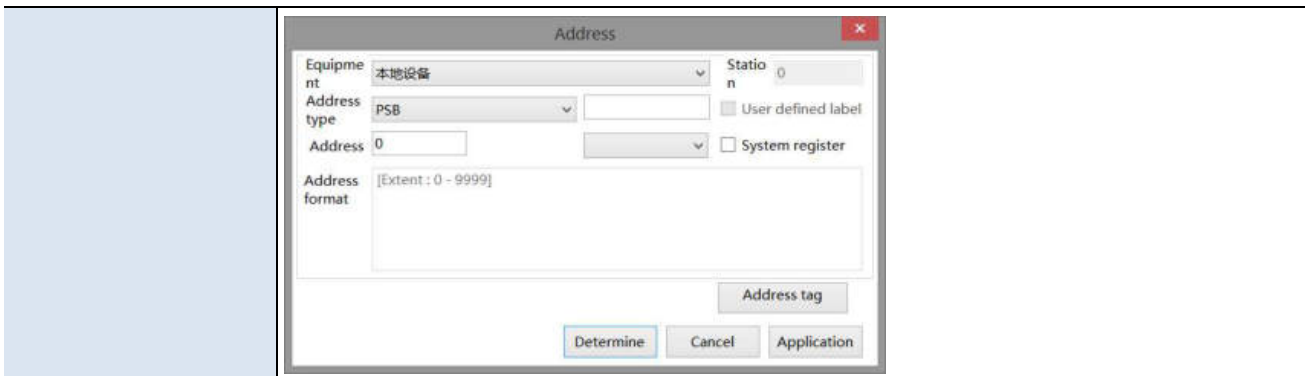

Security setting

Set the user's permission range and whether to pop up a prompt window when there is no permission

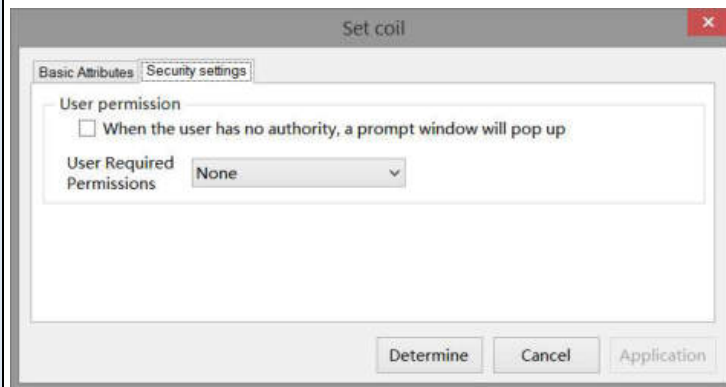

(2) Set data

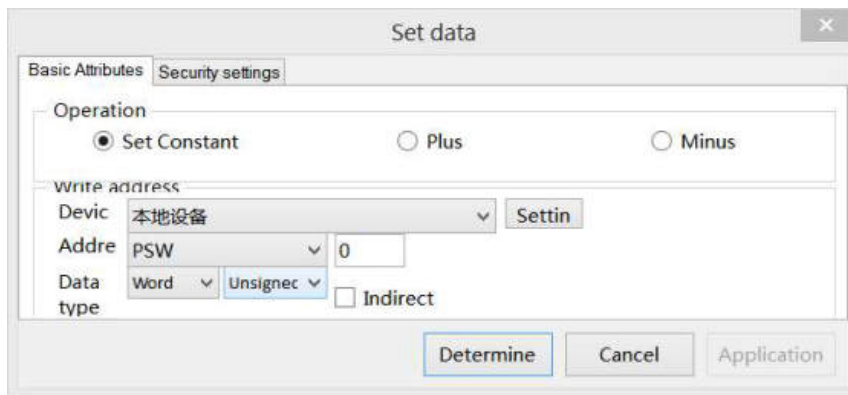

Operation	Constant	The specified value setting of the specified object is equivalent to the data setting (it can be set as a constant or specified through a register)
	Plus	You can set the value added each time (it can be set as a constant or specified through the register), and set the increment value and upper limit value and whether to cycle
	Minus	You can set the value of each decrement (which can be set as a constant or specified through the register), the decrement value, the lower limit value and whether to cycle
Write address		Set the write in address
Equipment		Current equipment port for communication
Address		Set the target coil address
Data type		Byte-8Bit, Word-16Bit, DWord- 32Bit, DDWord -64Bit, BCD format, Hex, Signed value, Unigned value, Floating number
Set		Click "Set" to enter the address setting interface, where you can set and use system registers and user-defined tags. You can click the address tag library below or the project

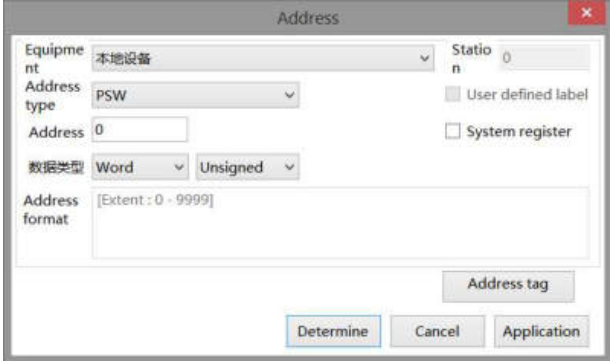
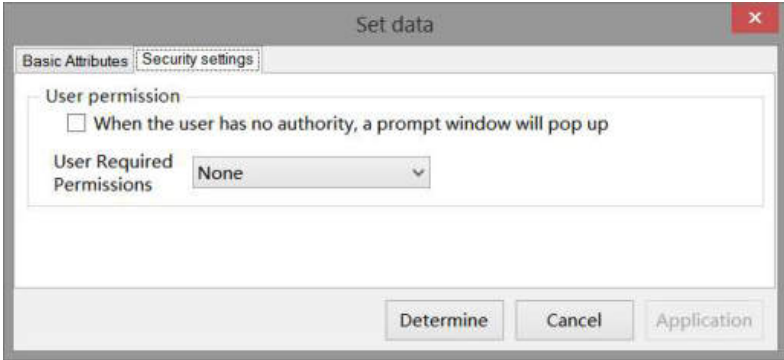
	<p>tree - library - address tag library to set the tags (see chapter 5-2 Address Tag Library for the use of address tag library and user-defined tags)</p> 
<p>Indirect assignment</p>	<p>Set the current address offset. The current coil address changes with the indirectly specified register value, that is, $Dx [Dy]=D [x+Dy \text{ value}]$ ($x, y=0, 1, 2, 3\dots$). For example, the current coil address is PSB0, if the indirectly assigned address is PSW100; When the value of PSW100 register is 0, the coil controlling this element is still PSB0; When the value of PSW100 register is 1, the coil controlling this element is PSB1 (and so on)</p>
<p>Security setting</p>	<p>Set the user's permission range and whether to pop up a prompt window when there is no permission</p> 

(3) Arithmetic

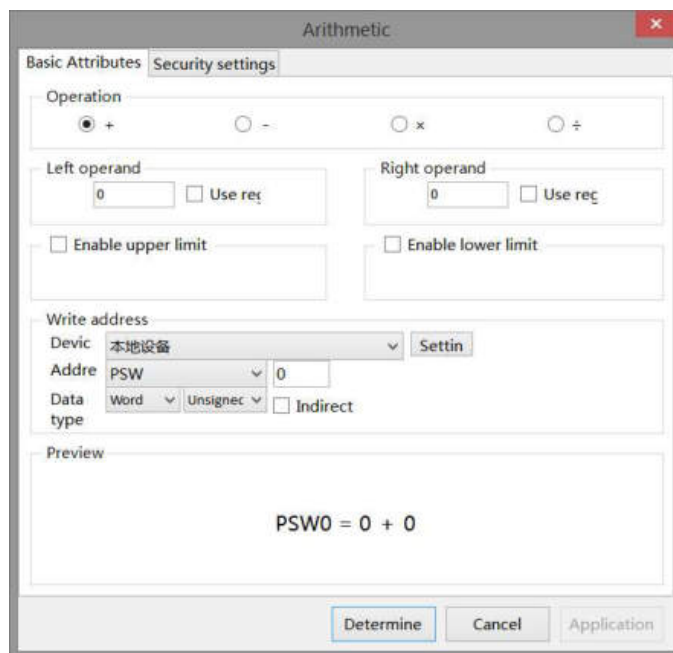

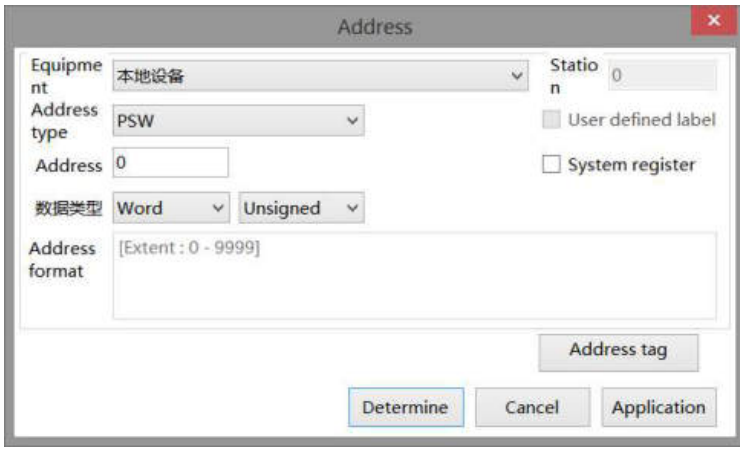
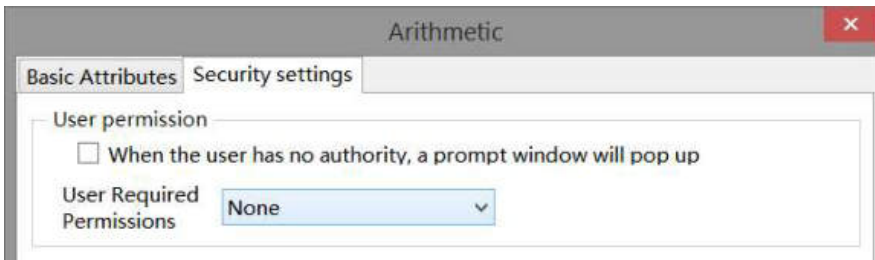
Operation	From left to right, add (+), subtract (-), multiply (×), Divide (÷)
Left operand	Sets the value of the left operand, which can be a constant or specified by a register
Right operand	Sets the value of the right operand, which can be a constant or specified by a register
Enable upper limit	Function key - for upper limit of the arithmetic object register, you can enter a constant or specify it by the register
Enable lower limit	Function key – for lower limit of the arithmetic object register, you can enter a constant or specify it by the register
Write address	Set the write in address
Equipment	Current equipment port for communication
Set	Click "Set" to enter the address setting interface, where you can set and use system registers and user-defined tags. You can click the address tag library below or the project tree - library - address tag library to set the tags (see chapter 5-2 Address Tag Library for the use of address tag library and user-defined tags)
	
Address	Set the target register address
Data type	Byte-8Bit, Word-16Bit, DWord- 32Bit, DDWord -64Bit, BCD format, Hex, Signed value, Unsigned value, Floating number
Indirect assignment	Set the current address offset. The current coil address changes with the indirectly specified register value, that is, Dx [Dy]=D [x+Dy value] (x, y=0, 1, 2, 3...). For example, the current coil address is PSB0, if the indirectly assigned address is PSW100; When the value of PSW100 register is 0, the coil controlling this element is still PSB0; When the value of PSW100 register is 1, the coil controlling this element is PSB1 (and so on)
Security setting	Set the user's permission range and whether to pop up a prompt window when there is no permission
	

(4) Data transmission

Transfer the specified source register/coil data to the target register/coil, for batch data transmission.

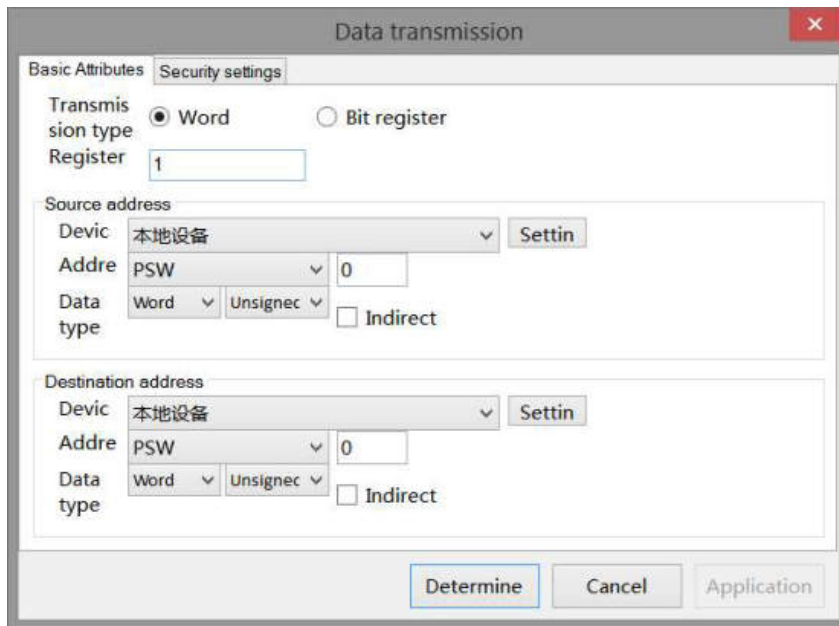

Transmission type	You can choose whether to transfer word register (register value) or bit register (coil status)
Number	The number of data block transfer can be set
Source address	Read the first address information of the register
Target address	Write the first address information of the register
Equipment	Current equipment port for communication
Address	Set the target register address
Set	Click "Set" to enter the address setting interface, where you can set and use system registers and user-defined tags. You can click the address tag library below or the project tree - library - address tag library to set the tags (see chapter 5-2 Address Tag Library for the use of address tag library and user-defined tags)
Indirect assignment	Set the current address offset. The current coil address changes with the indirectly specified register value, that is, $Dx [Dy]=D [x+Dy \text{ value}]$ (x, y=0, 1, 2, 3...). For example, the current coil address is PSB0, if the indirectly assigned address is PSW100; When the value of PSW100 register is 0, the coil controlling this element is still PSB0; When the value of PSW100 register is 1, the coil controlling this element is PSB1 (and so on)
Security setting	Set the user's permission range and whether to pop up a prompt window when there is no permission



(5) Screen switch

Jump to the specified screen.

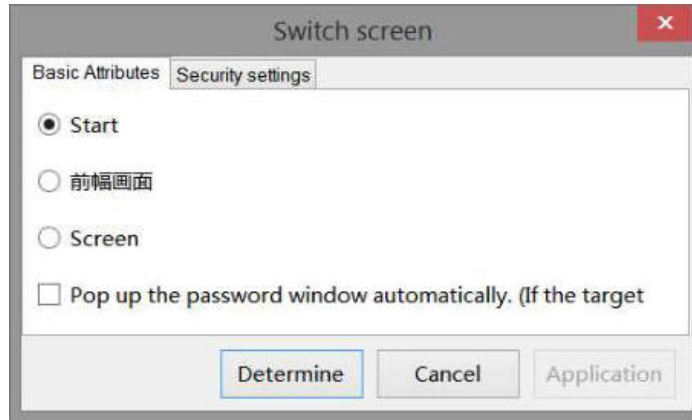

Start screen	System startup display screen
The last screen	Jump to the original screen
Screen ID	Select the screen ID to jump to
The password window will pop up automatically	If checked, and the screen to be switched has higher authority, the user login window will pop up automatically
Security setting	Set the user's permission range and whether to pop up a prompt window when there is no permission



(6) Call window

Switch or pop-up the specified window.

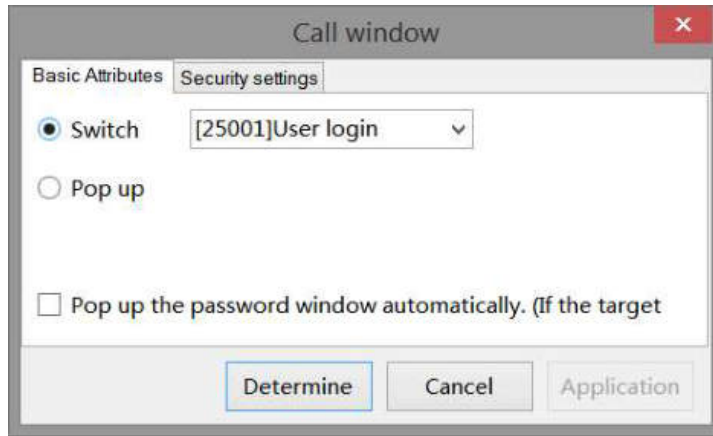

Switch window	The window number to be switched can be set; Switching can only pop up one window at the same time
Pop up	You can set the number of the window to pop up; Pop up can pop up multiple windows at the same time
The password window will pop up automatically	If checked, and the screen to be switched has higher authority, the user login window will pop up automatically
Security setting	Set the user's permission range and whether to pop up a prompt window when there is no permission

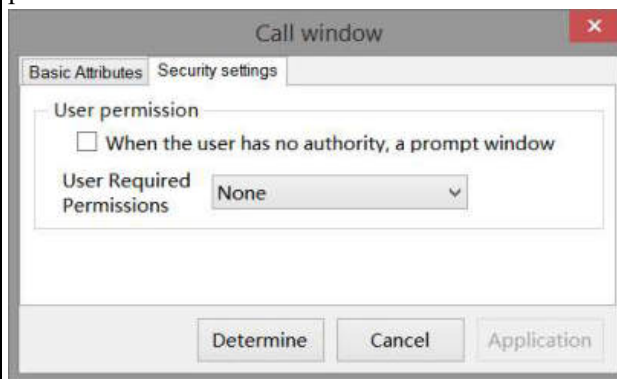

(7) Close window

You can choose to close the specified window or all windows.

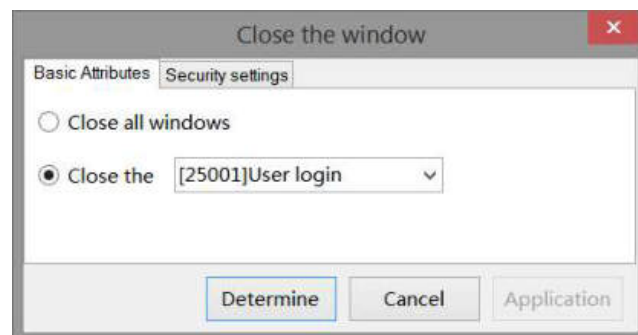

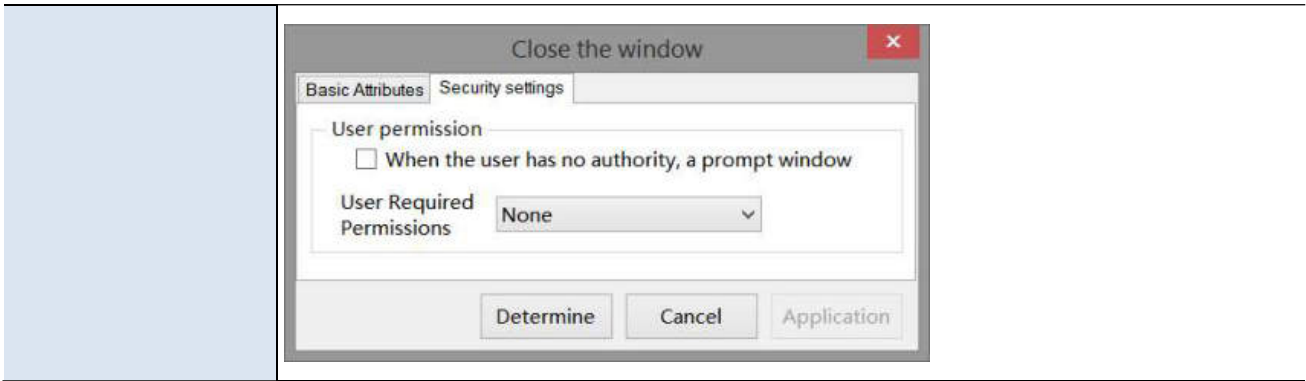

Close all the window	All windows of the current screen can be closed
Close window	The window number to be closed can be set
Security setting	Set the user's permission range and whether to pop up a prompt window when there is no permission

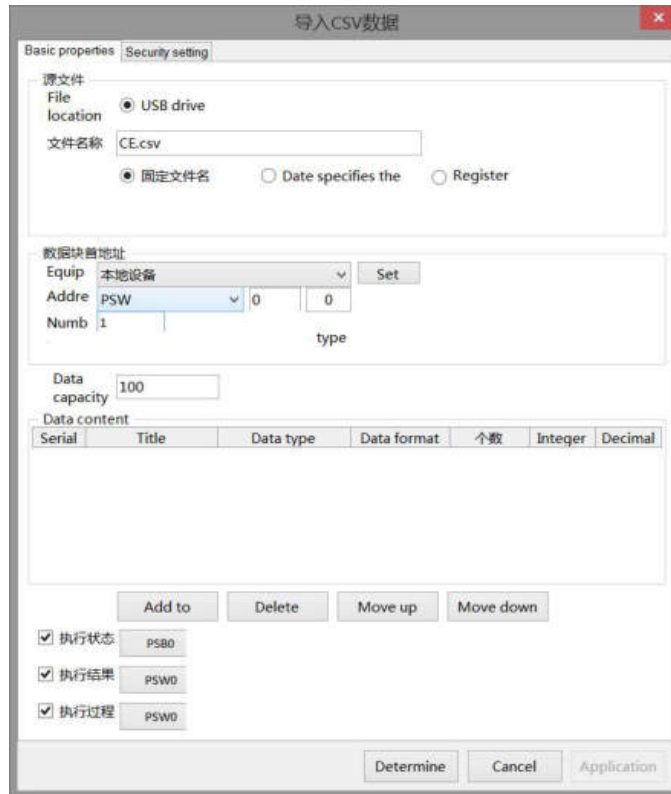

(8) Import csv data

The previously stored data can be called in for reference or updated in the HMI.



Source file	File location	You can only import from the USB flash disk.  When simulating, the storage location for imported files is in the software directory: Temp/Run/storage/udisk.
	File name	It can be set as a fixed file name (the file name is defined by itself), a file name specified by the date, or a file name specified by the contents of the register (the file name only supports characters, not Chinese, and cannot contain special characters)
Data block start address		Set the object type and first address of the import destination address, which is generally set as the internal register PSW or PFW of the HMI
Equipment		Current equipment port for communication
Address		Set target register number
Custom Data Type		If it is not checked, the default type is Word, and you can also select Dword or DDword; Byte-8Bit, Word-16Bit, DWord- 32Bit, DDWord -64Bit, BCD format, Hex, Signed value, Unigned value, Floating number

Data capacity	Data capacity to be imported each time (maximum data capacity 65535)
Data content	Select the same title, data type, data format, number of words, integer digits, and decimal digits as the table to be imported
Add to/delete	Add/delete imported row information
Move up/down	Change the order of added lines
Execution status	The bit indicates whether it is in the import status. When it is ON, it indicates that it is in the import status. After the import is successful, the OFF status will be restored
Execution result	The running result of the import operation is represented by the value in the register; 0: Import succeeded; 1: Wrong file name; 2: Error file index; 3: The file path does not exist; 4: File creation failed; 5: The import data format does not match; 6: Export data failed; 7: Error in reading and writing PLC; 8: The USB drive has been ejected
Execution process	The implementation progress of the import is indicated by numerical display (the progress is indicated by a numerical value between 0 and 100, and 100 indicates completion)
Security setting	Set the user's permission range and whether to pop up a prompt window when there is no permission



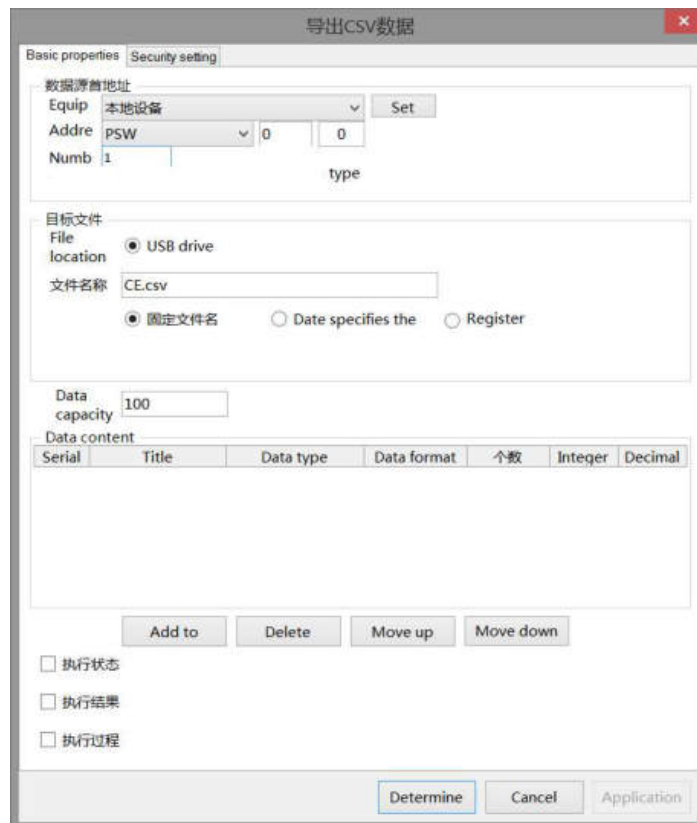

(9) Export csv data

This function can transfer the data in the HMI to the USB flash disk in the form of CSV files.



Data source start address	Set the data type and first address of the export data, which is generally set as the internal register PSW or PFW of the HMI
---------------------------	---

Equipment	Current equipment port for communication	
Address	Set the target register address	
Custom Data Type	If it is not checked, the default type is Word, and you can also select Dword or DDword; Byte-8Bit, Word-16Bit, DWord- 32Bit, DDWord -64Bit, BCD format, Hex, Signed value, Unsigned value, Floating number	
Target file	File location	Only the USB flash disk position can be selected for export.  When simulating, the storage location for imported files is in the software directory: Temp/Run/storage/udisk.
	File name	It can be set as a fixed file name (the file name is defined by itself), a file name specified by the date, or a file name specified by the contents of the register (the file name only supports characters, not Chinese, and cannot contain special characters)
Data capacity	Data capacity to be exported each time (maximum data capacity 65535)	
Data content	Select the same title, data type, data format, number of words, integer digits, and decimal digits as the table to be imported	
Add to/delete	Add/delete imported row information	
Move up/down	Change the order of added lines	
Execution status	The bit indicates whether it is in the export status. When it is ON, it indicates that it is in the export status. After the export is successful, the OFF status will be restored	
Execution result	The running result of the export operation is represented by the value in the register; 0: Export succeeded; 1: Wrong file name; 2: Error file index; 3: The file path does not exist; 4: File creation failed; 5: The import data format does not match; 6: Export data failed; 7: Error in reading and writing PLC; 8: The USB drive has been ejected	
Execution process	The exported execution progress is represented by numerical display (the progress is represented by a numerical value between 0 and 100, and 100 indicates completion)	
Security setting	Set the user's permission range and whether to pop up a prompt window when there is no permission 	

(10) Upload recipe

Upload the recipe data in the corresponding equipment data area to the HMI.

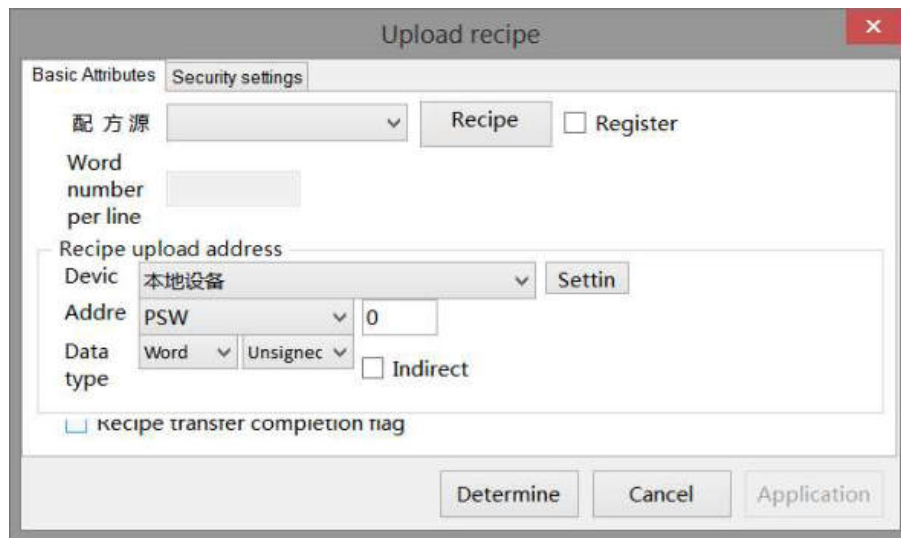

Recipe source	Data upload object register address (click recipe configuration to set relevant information about the recipe, and refer to chapter 4-6 recipe)	
Register	When this option is checked, the value in the register can be used to control which recipe group is exported (if the value in the register is 0, it means that the upload and download of recipe group 0 is performed at this time; if the value in the register is 1, it means that the upload and download of recipe group 1 is performed at this time)	
Words per line	The number of words in each line is calculated according to the selected recipe source and cannot be modified	
Recipe upload address	Equipment	Current equipment port for communication
	Set	Click "Set" to enter the address setting interface, where you can set and use system registers and user-defined tags. You can click the address tag library below or the project tree - library - address tag library to set the tags (see chapter 5-2 Address Tag Library for the use of address tag library and user-defined tags)
	Address	Set the target register address
	Data type	Byte-8Bit, Word-16Bit, DWord- 32Bit, DDWord -64Bit, BCD format, Hex, Signed value, Unsigned value, Floating number
Indirect assignment	Set the current address offset. The current register address changes with the indirectly specified register value, that is, $Dx [Dy]=D [x+Dy \text{ value}]$ ($x, y=0, 1, 2, 3\dots$). For example: the current register address is PSW0, if the indirectly specified address is PSW100; When the value of PSW100 register is 0, the register controlling this element is still PSW0; When the value of PSW100 register is 1, the register controlling this element is PSW1 (and so on)	
Recipe transfer completion flag	The indicator lights up when the recipe transfer is completed	

Security setting	Set the user's permission range and whether to pop up a prompt window when there is no permission
------------------	---

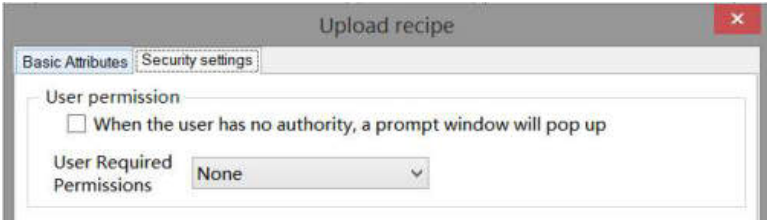

(11) Recipe download

Download the recipe data of the HMI to the corresponding equipment data area.

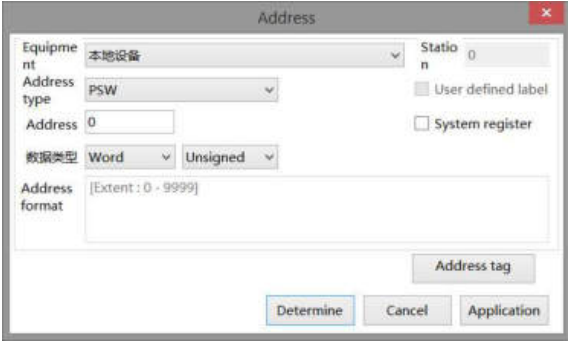
Recipe source	data Download object register address (click Recipe Configuration to set relevant information about recipe)	
Register assignment	When this option is checked, the value in the register can be used to control which recipe group is exported (if the value in the register is 0, it means that the upload and download of recipe group 0 is performed at this time; if the value in the register is 1, it means that the upload and download of recipe group 1 is performed at this time)	
Words per line	The number of words in each line is calculated according to the selected recipe source and cannot be modified	
Recipe download address	Equipment	Current equipment port for communication
	Set	Click "Set" to enter the address setting interface, where you can set and use system registers and user-defined tags. You can click the address tag library below or the project tree - library - address tag library to set the tags (see chapter 5-2 Address Tag Library for the use of address tag library and user-defined tags)
		
	Address	Set target register address
	Data type	Byte-8Bit, Word-16Bit, DWord- 32Bit, DDWord -64Bit, BCD format, Hex, Signed value, Unsigned value, Floating number
Indirect assignment	Set the current address offset. The current register address changes with the indirectly specified register value, that is, Dx [Dy]=D [x+Dy value] (x, y=0, 1, 2, 3...). For example: the current register address is PSW0, if the indirectly specified address is PSW100; When the value of PSW100 register is 0, the register controlling this element is still PSW0; When the value of PSW100 register is 1, the register controlling this element is PSW1 (and so on)	
Recipe transfer completion flag	The indicator lights up when the recipe transfer is completed	
Security setting	Set the user's permission range and whether to pop up a prompt window when there is no	

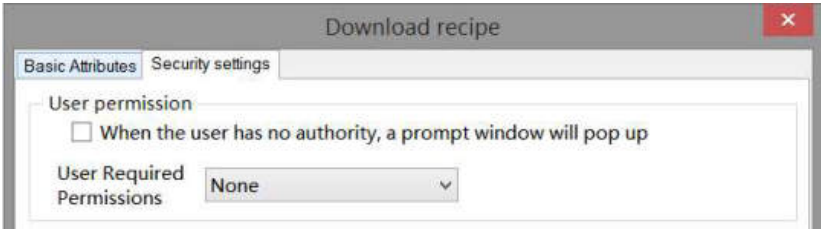
	<p>permission</p> 
--	--

(12) Call function

Calling the C language function can complete more complex operations and communications.

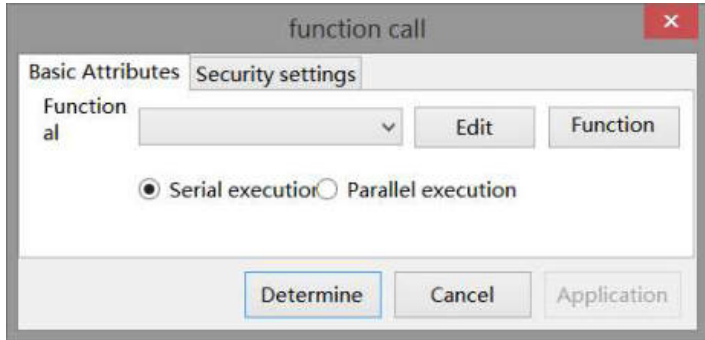

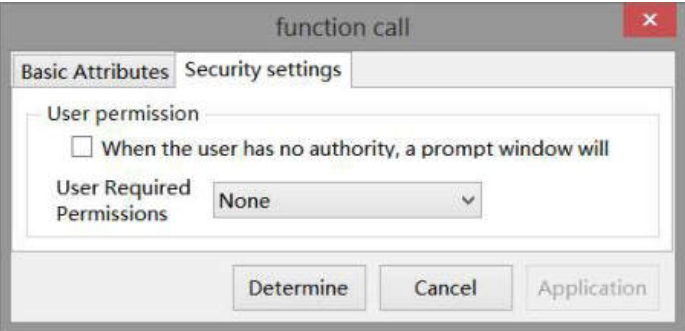
Function	Select the function to be called from the drop-down menu
Edit/function	Click to enter the function editing page
Serial execution	The next task can be done after the current task is completed. Therefore, this function must have appropriate exit conditions
Parallel execution	Call the task of this function, create a new task to execute the function, and the caller will continue the subsequent processing
Security setting	<p>Set the user's permission range and whether to pop up a prompt window when there is no permission</p> 

■ Appearance

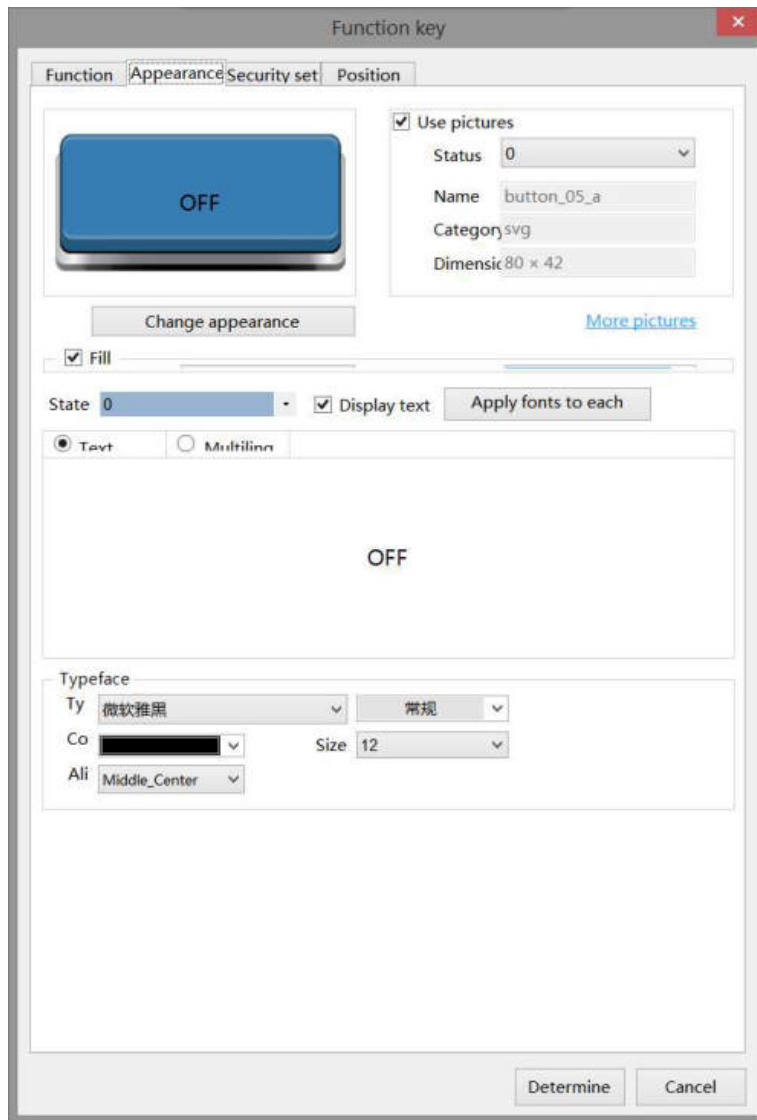

Change appearance	You can check whether to use pictures. If you check, you can set the appearance of the function keys in different states. After selecting the state in the upper right corner, click "Change Appearance" or click "More Pictures" to select a custom picture to change the appearance
Fill	Fill style (solid/gradient) and fill color can be set
State	You need to check "Display Text" to set the text prompt content of the function key in the (0, 1) two states. You can set whether to use multiple languages (see chapter 5-1 Label Multiple Languages for the specific use of multiple language libraries); Tick the drop-down list to set the font corresponding to the corresponding state of the function key, or click the "apply fonts to each state" button to set the font in all states
Typeface	You can set the font, size, font style, color and the display position of the font in the component

■ Security setting

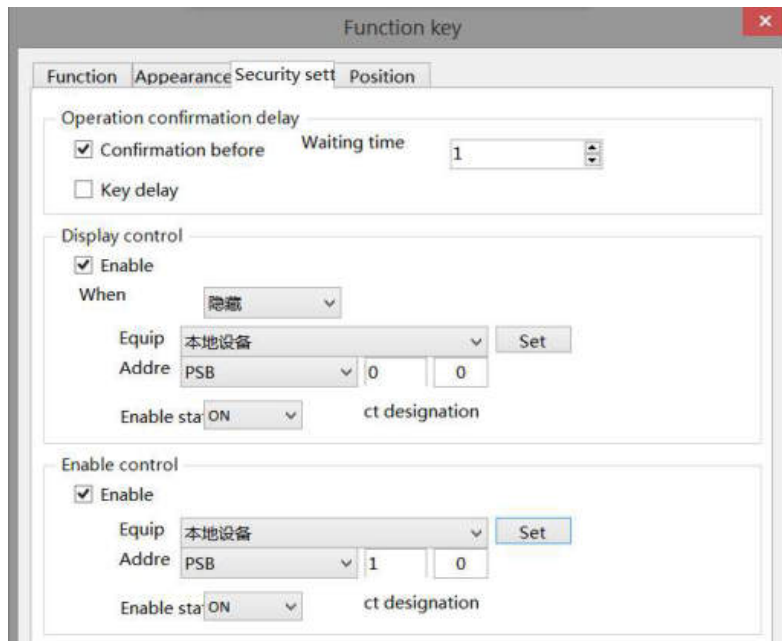

Operation confirmation delay	The waiting time (s) can be set. If this option is checked, a pop-up window "Are you sure to execute this operation" will pop up when operating components. If you do not click "Confirm" or "Cancel" within the set waiting time, the pop-up window will disappear by itself and this operation will fail; If you click "OK" within the waiting time, the operation is successful. Clicking "Cancel" is invalid
Key delay	The operation will not take effect until the set delay time is long pressed
Display control	Use bits to control whether to display the part. When the condition is not met, the component will be hidden. It is hidden by default and cannot be modified
Equipment	Current equipment port for communication
Address	Set the coil address for bit control
Indirect assignment	Set the current address offset. The current coil address changes with the indirectly specified register value, that is, $Dx [Dy]=D [x+Dy \text{ value}]$ (x, y=0, 1, 2, 3...). For example, the current coil address is PSB0, if the indirectly assigned address is PSW100; When the value of PSW100 register is 0, the coil controlling this element is still PSB0; When the value of PSW100 register is 1, the coil controlling this element is PSB1 (and so on)
Set	Click "Set" to enter the address setting interface, where you can set and use system registers and user-defined tags. You can click the address tag library below or the project tree - library - address tag library to set the tags (see chapter 5-2 Address Tag Library for the use of address tag library and user-defined tags)

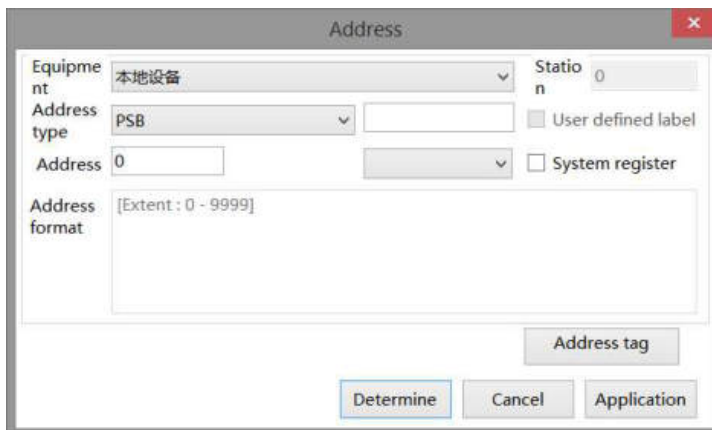

Enable	When checked, display control will be enabled
When validation fails	Set the display of the component when validation fails
Enable state	Set ON status to be valid or OFF status to be valid. For example: if the equipment is checked as shown in the above figure, the bit control is PSB0, and hide is selected when validation fails, and the enabling status is ON, then when the status of PSB0 is ON, the component is normally displayed, and when the status of PSB0 is OFF, the component is hidden and not displayed.
Enable control	The bit limit can be set (the enabling state of the enable control can be customized). When the enabling conditions are met, the component can be used normally (as shown in the figure above: when the PSB1 is in the ON state and the trigger conditions are met at the same time, the component can be used; if the PSB1 is in the OFF state, the component is still unavailable even if the trigger conditions are met)

■ Position

Same to chapter 4-1-1 straight line position part.

(13)Screen printing

Print current information through printer.

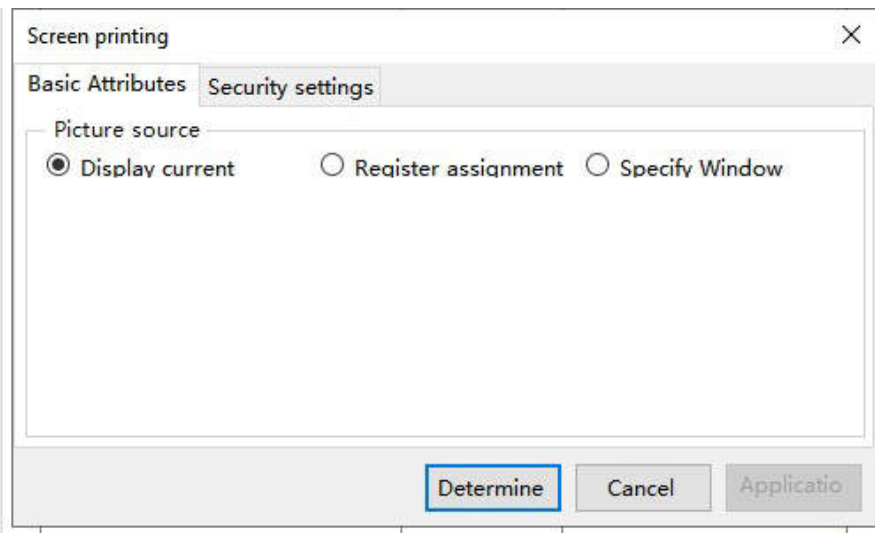

Picture source	Current display window, register specified, specified window
----------------	--

The connection and configuration of the printer are detailed in chapter 3-10-7 Printer.

4-2-16. Function domain

The function is the same as the function key. This part is a hidden component in the screen, and the specified action will be executed when the required conditions are met. Different from the function keys that need to be manually triggered, the function domain is automatically triggered after the set conditions are met, not only by the key triggering. For the hidden effect in the screen, the function field is generally set as a common component in use, to achieve the purpose that it can be executed in all screens.

1. Click the menu bar "Part/Key/Function domain" or the control window basic part bar  icon, move the cursor to the screen, click the left mouse button to place, click the right mouse button or click ESC to cancel the placement. Modify the control length and height through the boundary point.
2. When setting attributes, you can set them in the attribute box that pops up when placing components. You can also double-click the "Function domain" or select the "Function domain" and right-click to select "Attribute" to set attributes.

■ Pattern

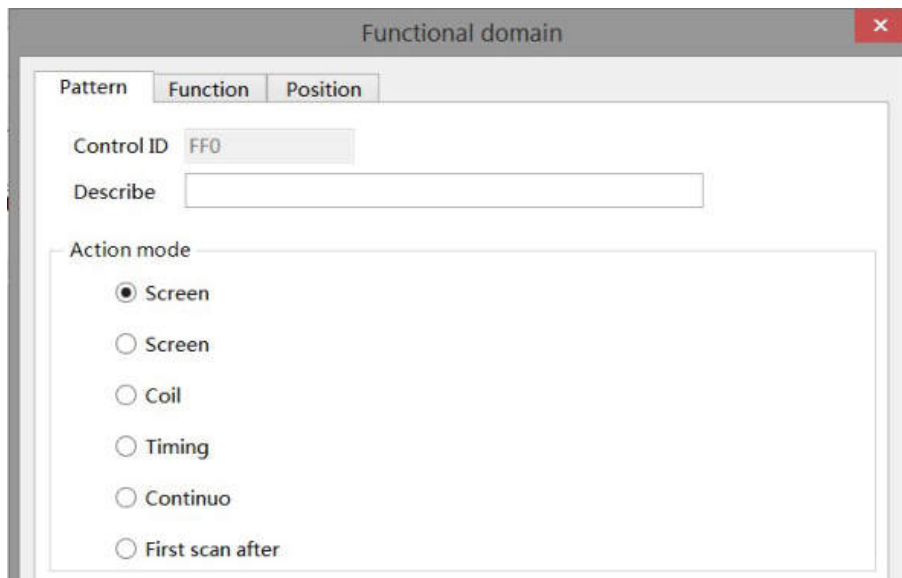

Control ID	It is used for system management control and cannot be operated by users
Describe	Can be used to comment on the purpose of this component
Action mode	Set the operation mode. You can only select one trigger action
Screen start	The first scan after the start of the screen where the function domain is located, and the relevant functions are executed once
Screen close	The first scan after the screen where the function domain is located is closed, and the relevant functions are executed once
Coil	The rising edge means that when the specified coil jumps from OFF to ON, the relevant functions are executed once The falling edge means that when the specified coil jumps from ON to OFF, the relevant functions are executed once
Timing	When the screen is called, after all functions are executed, there are 2 options below for the next execution time: 1. "Timing/continuous mode coil limit" controls whether the current mode is executed according to the ON/OFF of the coil 2. "Display timing interval time" user-defined display register to display timing interval in real time (unit: ms), which can only be displayed but not set

Continue	When the screen is called, each scan will execute relevant functions When the "Timing (seconds)" or "Continuous" option is selected, the "Timing/Continuous Mode Coil Limit" can be selected to set the control coil, that is, when only this coil is set to ON/OFF, this function executes
First scan after downloading	For the first scan after downloading the screen, relevant functions are executed once, and the simulation is invalid
First scan after startup	The first scan after the system is powered on and started, and the relevant functions are executed once, and the simulation is invalid
Logic	Only when the value of the specified register is $<$, $>$, \leq , \geq , $==$ the constant value, the relevant function is executed once Note: When the specified register is a floating point number, a setting for the number of decimal places will be added. During the setting, pay attention to the consistency between the number of decimal places set for the constant value and the number of decimal places set. 

■ Function

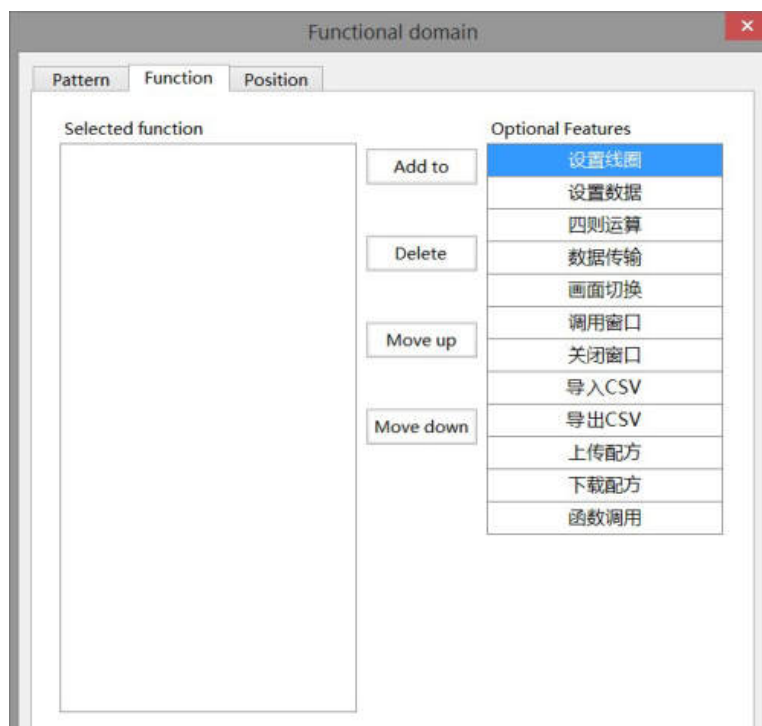

Item	Add to	Add the function
	Delete	Delete the function
	Move up	Move the target function up one physical location

	Move down	Move the target function down one physical location
Optional features		Select the corresponding function, click the "Add" button to add the function item to the left list. Double click the selected function to enter the setting window

(1) Set coil

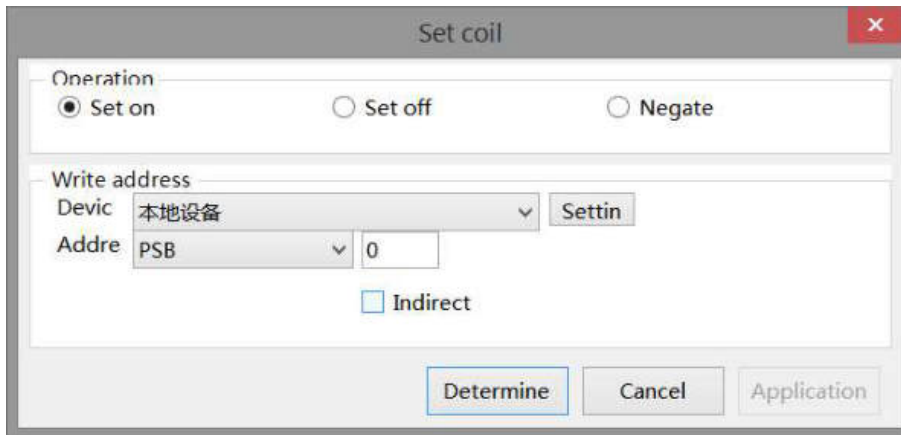

Operation	Set ON	Set the control coil to logic 1 state
	Set OFF	Set the control coil to logic 0
	Reverse	Set the control coil to the opposite state
Write address	Set the write in address	
Equipment	Current equipment port for communication	
Address	Set target coil address	
Indirect assignment	Set the current address offset. The current coil address changes with the indirectly specified register value, that is, $Dx[Dy]=D[x+Dy \text{ value}]$ ($x, y=0, 1, 2, 3\dots$). For example, the current coil address is PSB0, if the indirectly assigned address is PSW100; When the value of PSW100 register is 0, the coil controlling this element is still PSB0; When the value of PSW100 register is 1, the coil controlling this element is PSB1 (and so on)	
Set	Click "Set" to enter the address setting interface, where you can set and use system registers and user-defined tags. You can click the address tag library below or the project tree - library - address tag library to set the tags (see chapter 5-2 Address Tag Library for the use of address tag library and user-defined tags)	

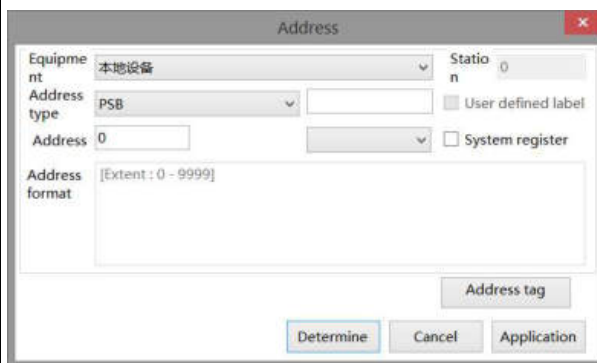

(2) Set data

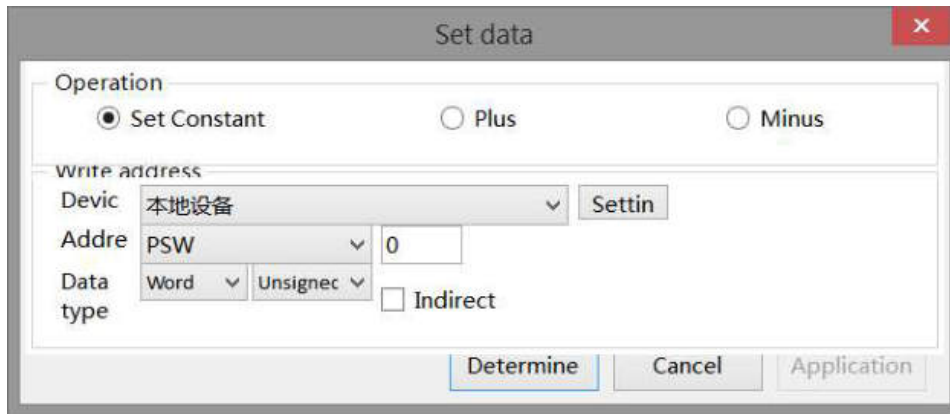

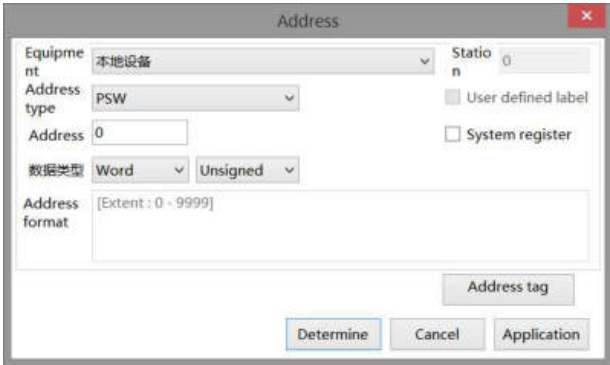
Operation	Constant	The specified value setting of the specified object is equivalent to the data setting (it can be set as a constant or specified through a register)
	Plus	You can set the value added each time (it can be set as a constant or specified through the register), and set the increment value and upper limit value and whether to cycle
	Minus	You can set the value of each decrement (which can be set as a constant or specified through the register), the decrement value, the lower limit value and whether to cycle
Write address		Set the write in address
Equipment		Current equipment port for communication
Address		Set the target coil address
Data type		Byte-8Bit, Word-16Bit, DWord- 32Bit, DDWord -64Bit, BCD format, Hex, Signed value, Unsigned value, Floating number
Set		<p>Click "Set" to enter the address setting interface, where you can set and use system registers and user-defined tags. You can click the address tag library below or the project tree - library - address tag library to set the tags (see chapter 5-2 Address Tag Library for the use of address tag library and user-defined tags)</p> 
Indirect assignment		Set the current address offset. The current coil address changes with the indirectly specified register value, that is, $Dx [Dy]=D [x+Dy \text{ value}]$ ($x, y=0, 1, 2, 3\dots$). For example, the current coil address is PSB0, if the indirectly assigned address is PSW100; When the value of PSW100 register is 0, the coil controlling this element is still PSB0; When the value of PSW100 register is 1, the coil controlling this element is PSB1 (and so on)

(3) Arithmetic

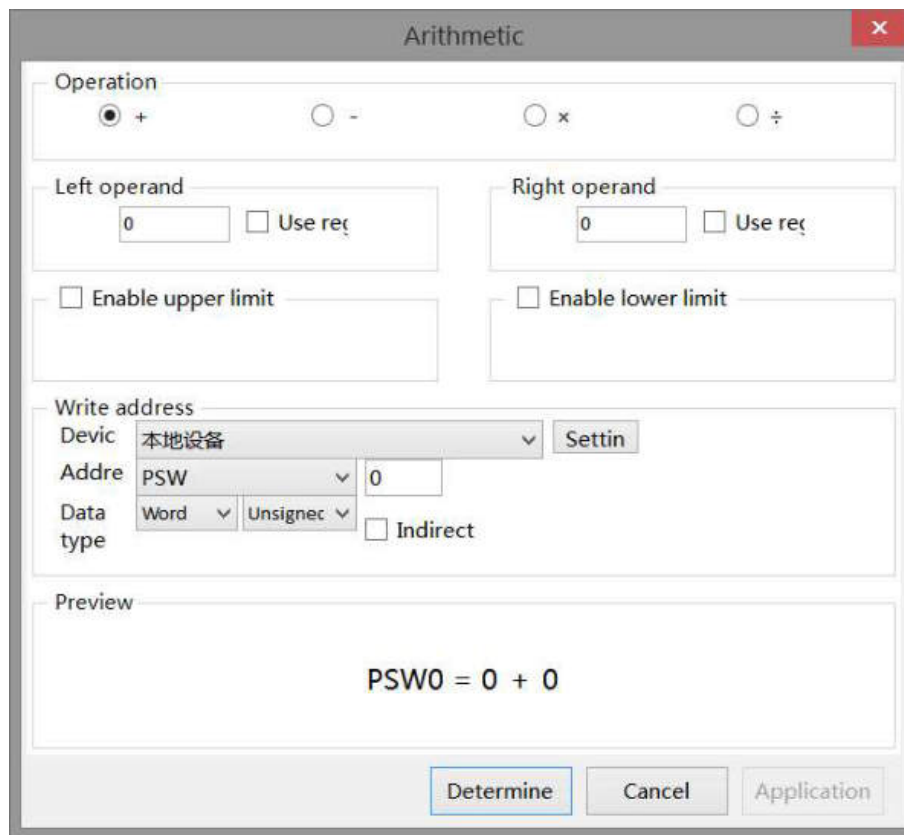

Operation	From left to right, add (+), subtract (-), multiply (×), Divide (÷)
Left operand	Sets the value of the left operand, which can be a constant or specified by a register
Right operand	Sets the value of the right operand, which can be a constant or specified by a register
Enable upper limit	Function key - for upper limit of the arithmetic object register, you can enter a constant or specify it by the register
Enable lower limit	Function key – for lower limit of the arithmetic object register, you can enter a constant or specify it by the register
Write address	Set the write in address
Equipment	Current equipment port for communication
Set	Click "Set" to enter the address setting interface, where you can set and use system registers and user-defined tags. You can click the address tag library below or the project tree - library - address tag library to set the tags (see chapter 5-2 Address Tag Library for the use of address tag library and user-defined tags)

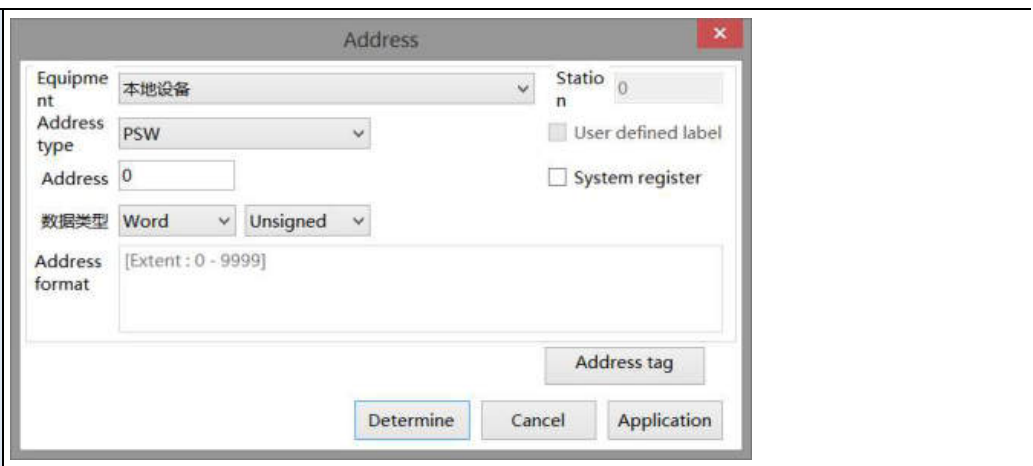
	
Address	Set the target register address
Data type	Byte-8Bit, Word-16Bit, DWord- 32Bit, DDWord -64Bit, BCD format, Hex, Signed value, Unigned value, Floating number
Indirect assignment	Set the current address offset. The current coil address changes with the indirectly specified register value, that is, Dx [Dy]=D [x+Dy value] (x, y=0, 1, 2, 3...). For example, the current coil address is PSB0, if the indirectly assigned address is PSW100; When the value of PSW100 register is 0, the coil controlling this element is still PSB0; When the value of PSW100 register is 1, the coil controlling this element is PSB1 (and so on)

(4) Data transmission

Transfer the specified source register/coil data to the target register/coil, for batch data transmission.

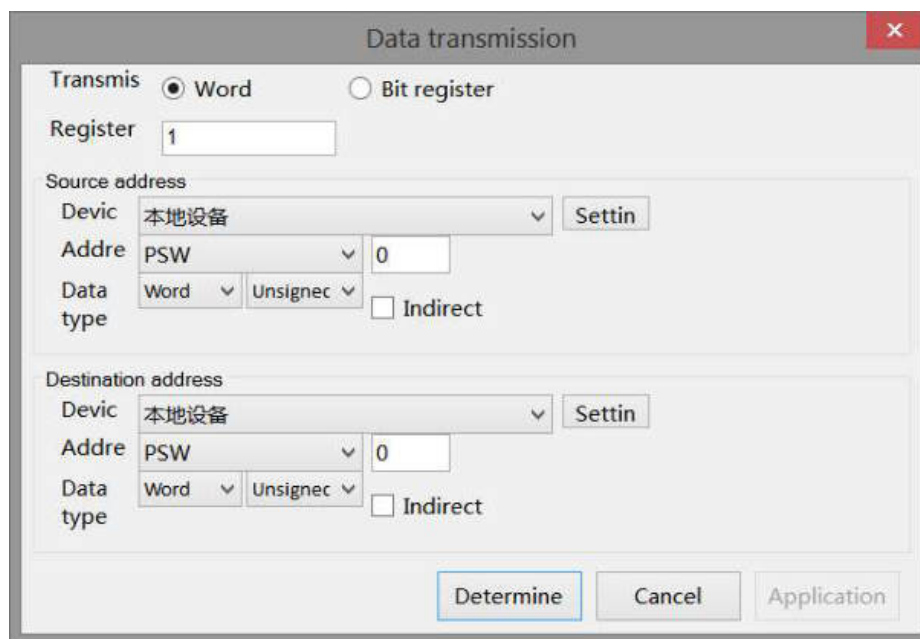

Transmission type	You can choose whether to transfer word register (register value) or bit register (coil status)
Number	The number of data block transfer can be set
Source address	Read the first address information of the register
Target address	Write the first address information of the register
Equipment	Current equipment port for communication
Address	Set the target register address
Set	Click "Set" to enter the address setting interface, where you can set and use system

registers and user-defined tags. You can click the address tag library below or the project tree - library - address tag library to set the tags (see chapter 5-2 Address Tag Library for the use of address tag library and user-defined tags)

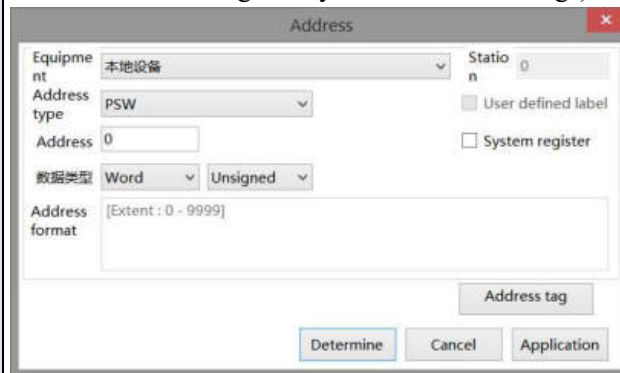

Indirect assignment	Set the current address offset. The current coil address changes with the indirectly specified register value, that is, Dx [Dy]=D [x+Dy value] (x, y=0, 1, 2, 3...). For example, the current coil address is PSB0, if the indirectly assigned address is PSW100; When the value of PSW100 register is 0, the coil controlling this element is still PSB0; When the value of PSW100 register is 1, the coil controlling this element is PSB1 (and so on)
---------------------	--

(5) Screen switch

Jump to the specified screen.

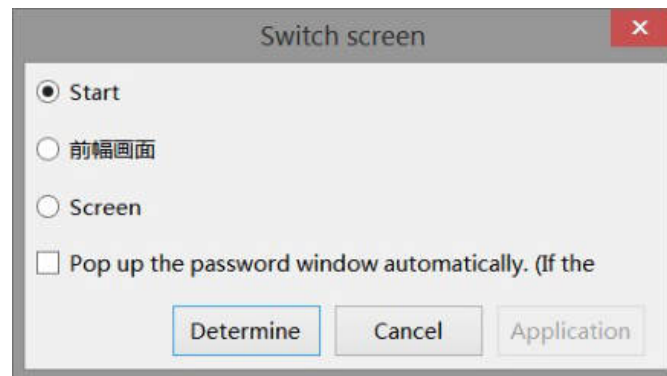

Start screen	System startup display screen
The last screen	Jump to the original screen
Screen ID	Select the screen ID to jump to
The password window will pop up automatically	If checked, and the screen to be switched has higher authority, the user login window will pop up automatically

(6) Call window

Switch or pop-up the specified window.

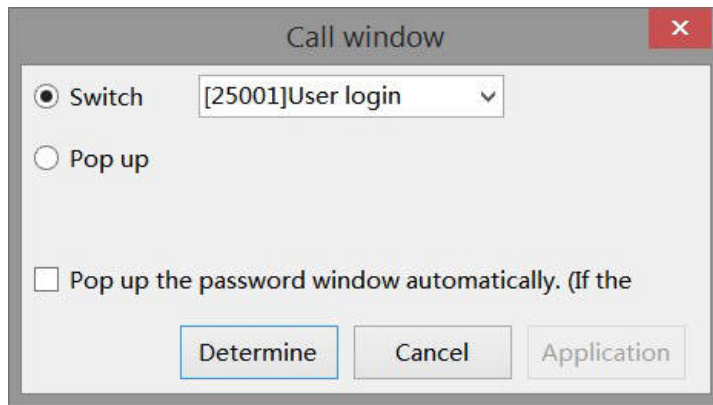

Switch window	The window number to be switched can be set; Switching can only pop up one window at the same time
Pop up	You can set the number of the window to pop up; Pop up can pop up multiple windows at the same time
The password window will pop up automatically	If checked, and the screen to be switched has higher authority, the user login window will pop up automatically

(7) Close window

You can choose to close the specified window or all windows.

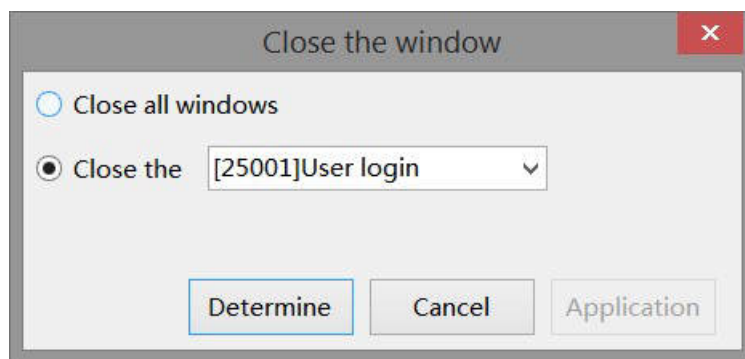

Close all the window	All windows of the current screen can be closed
Close window	The window number to be closed can be set

(8) Import csv data

The previously stored data can be called in for reference or updated in the HMI.

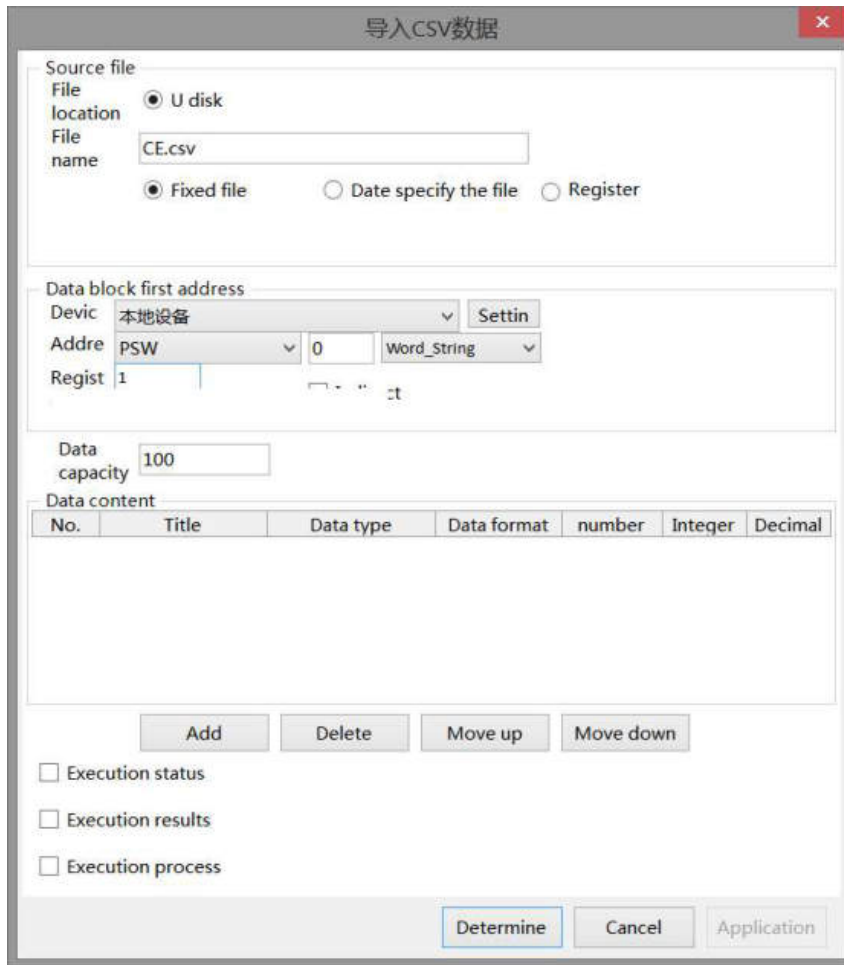



Source file	File location	You can only import from the USB flash disk.  When simulating, the storage location for imported files is in the software directory: Temp/Run/storage/udisk.
	File name	It can be set as a fixed file name (the file name is defined by itself), a file name specified by the date, or a file name specified by the contents of the register (the file name only supports characters, not Chinese, and cannot contain special characters)
Data block start address		Set the object type and first address of the import destination address, which is generally set as the internal register PSW or PFW of the HMI
Equipment		Current equipment port for communication
Address		Set target register number
Custom Data Type		If it is not checked, the default type is Word, and you can also select Dword or DDword; Byte-8Bit, Word-16Bit, DWord- 32Bit, DDWord -64Bit, BCD format, Hex, Signed value, Unigned value, Floating number
Data capacity		Data capacity to be imported each time (maximum data capacity 65535)
Data content		Select the same title, data type, data format, number of words, integer digits, and decimal digits as the table to be imported
Add to/delete		Add/delete imported row information
Move up/down		Change the order of added lines
Execution status		The bit indicates whether it is in the import status. When it is ON, it indicates that it is in the import status. After the import is successful, the OFF status will be restored
Execution result		The running result of the import operation is represented by the value in the register;

	0: Import succeeded; 1: Wrong file name; 2: Error file index; 3: The file path does not exist; 4: File creation failed
Execution process	The implementation progress of the import is indicated by numerical display (the progress is indicated by a numerical value between 0 and 100, and 100 indicates completion)

(9) Export csv data

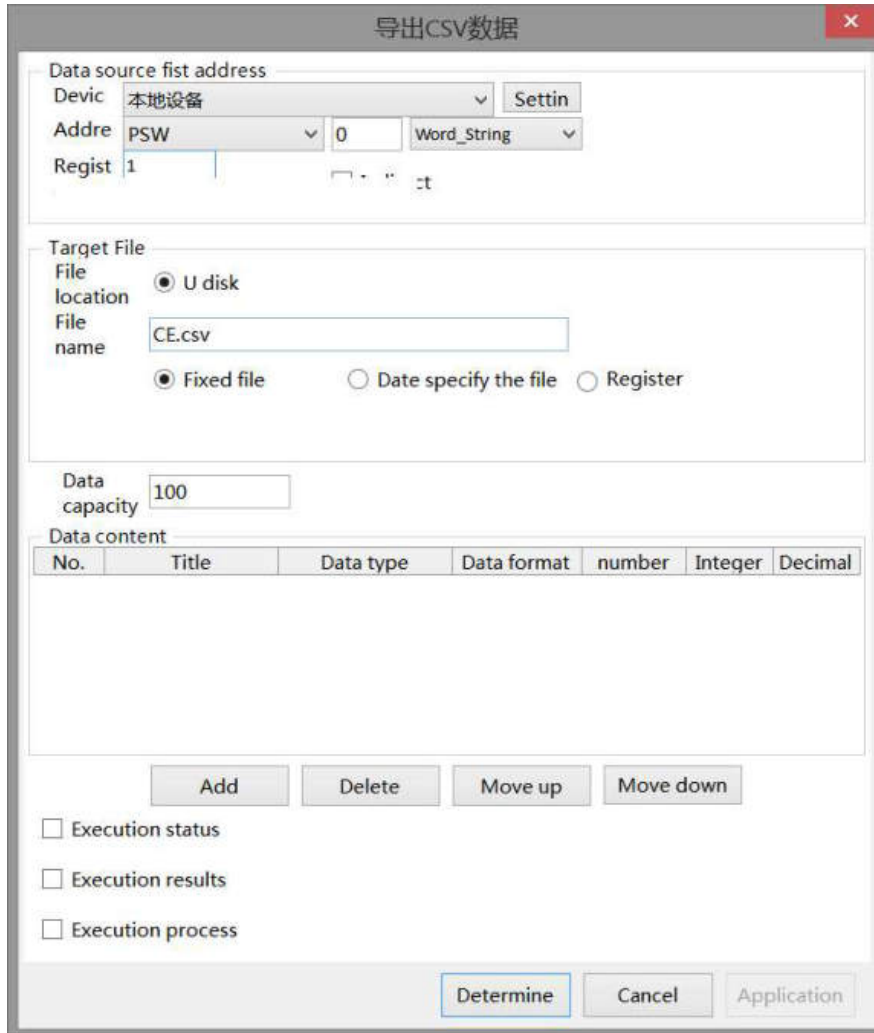
This function can transfer the data in the HMI to the USB flash disk in the form of CSV files.



Data source start address	Set the data type and first address of the export data, which is generally set as the internal register PSW or PFW of the HMI
Equipment	Current equipment port for communication
Address	Set the target register address
Custom Data Type	If it is not checked, the default type is Word, and you can also select Dword or DDword; Byte-8Bit, Word-16Bit, DWord- 32Bit, DDWord -64Bit, BCD format, Hex, Signed value, Unigned value, Floating number
Target file	File location  Only the USB flash disk position can be selected for export. When simulating, the storage location for imported files is in the software directory: Temp/Run/storage/udisk.
	File name

Data capacity	Data capacity to be exported each time (maximum data capacity 65535)
Data content	Select the same title, data type, data format, number of words, integer digits, and decimal digits as the table to be imported
Add to/delete	Add/delete imported row information
Move up/down	Change the order of added lines
Execution status	The bit indicates whether it is in the export status. When it is ON, it indicates that it is in the export status. After the export is successful, the OFF status will be restored
Execution result	The running result of the export operation is represented by the value in the register; 0: Export succeeded; 1: Wrong file name; 2: Error file index; 3: The file path does not exist; 4: File creation failed
Execution process	The exported execution progress is represented by numerical display (the progress is represented by a numerical value between 0 and 100, and 100 indicates completion)

(10) Upload recipe

Upload the recipe data in the corresponding equipment data area to the HMI.

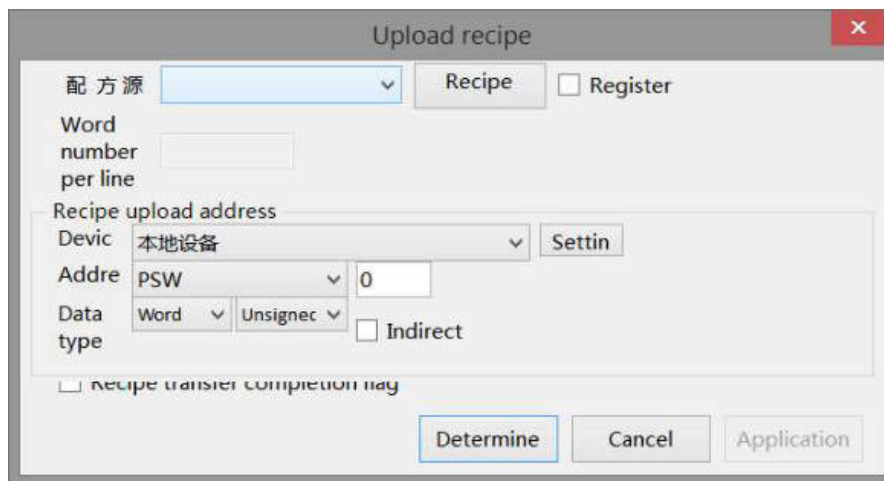

Recipe source	Data upload object register address (click recipe configuration to set relevant information about the recipe, and refer to chapter 4-6 recipe)	
Register	When this option is checked, the value in the register can be used to control which recipe group is exported (if the value in the register is 0, it means that the upload and download of recipe group 0 is performed at this time; if the value in the register is 1, it means that the upload and download of recipe group 1 is performed at this time)	
Words per line	The number of words in each line is calculated according to the selected recipe source and cannot be modified	
Recipe upload address	Equipment	Current equipment port for communication
	Set	Click "Set" to enter the address setting interface, where you can set and use system registers and user-defined tags. You can click the address tag library below or the project tree - library - address tag library to set the tags (see chapter 5-2 Address Tag Library for the use of address tag library and user-defined tags)

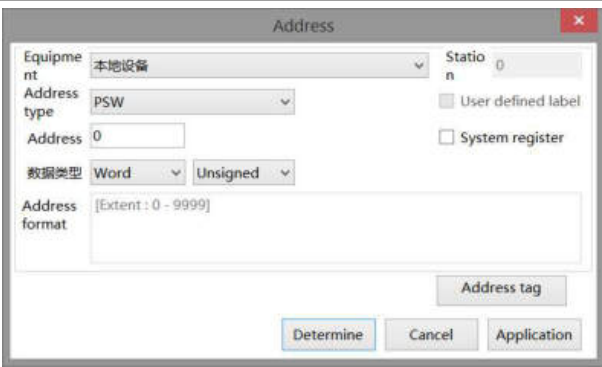
		
	Address	Set the target register address
	Data type	Byte-8Bit, Word-16Bit, DWord- 32Bit, DDWord -64Bit, BCD format, Hex, Signed value, Unigned value, Floating number
	Indirect assignment	Set the current address offset. The current register address changes with the indirectly specified register value, that is, Dx [Dy]=D [x+Dy value] (x, y=0, 1, 2, 3...). For example: the current register address is PSW0, if the indirectly specified address is PSW100; When the value of PSW100 register is 0, the register controlling this element is still PSW0; When the value of PSW100 register is 1, the register controlling this element is PSW1 (and so on)
	Recipe transfer completion flag	The indicator lights up when the recipe transfer is completed

(11) Recipe download

Download the recipe data of the HMI to the corresponding equipment data area.

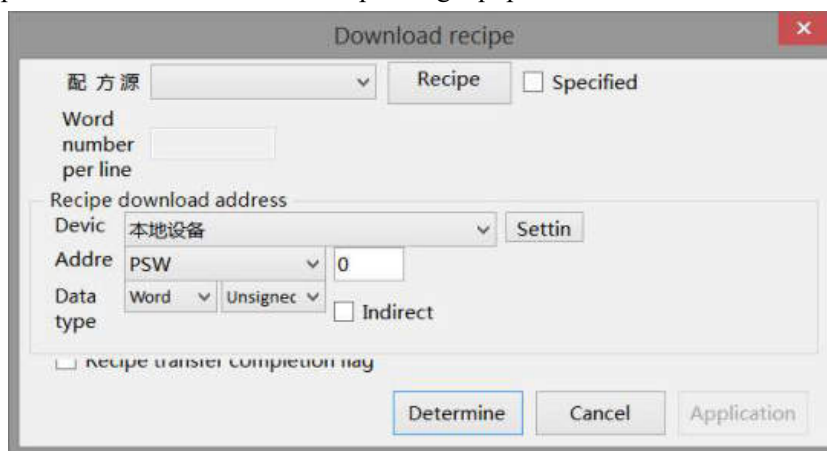

	Recipe source	data Download object register address (click Recipe Configuration to set relevant information about recipe)
	Register assignment	When this option is checked, the value in the register can be used to control which recipe group is exported (if the value in the register is 0, it means that the upload and download of recipe group 0 is performed at this time; if the value in the register is 1, it means that the upload and download of recipe group 1 is performed at this time)
	Words per line	The number of words in each line is calculated according to the selected recipe source and cannot be modified
Recipe download address	Equipment	Current equipment port for communication
	Set	Click "Set" to enter the address setting interface, where you can set and use system registers and user-defined tags. You can click the address tag library below or the project tree - library - address tag library to set the tags (see chapter 5-2 Address Tag Library for

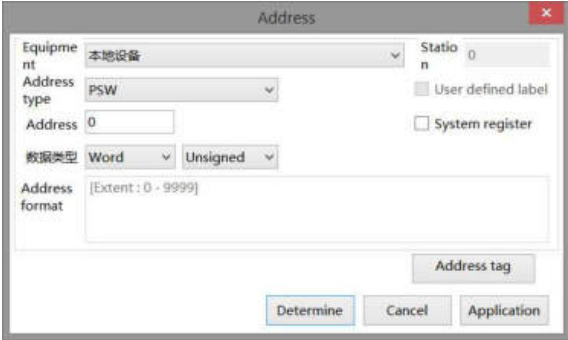
		the use of address tag library and user-defined tags)
		
	Address	Set target register address
	Data type	Byte-8Bit, Word-16Bit, DWord- 32Bit, DDWord -64Bit, BCD format, Hex, Signed value, Unsigned value, Floating number
	Indirect assignment	Set the current address offset. The current register address changes with the indirectly specified register value, that is, $Dx [Dy]=D [x+Dy \text{ value}]$ (x, y=0, 1, 2, 3...). For example: the current register address is PSW0, if the indirectly specified address is PSW100; When the value of PSW100 register is 0, the register controlling this element is still PSW0; When the value of PSW100 register is 1, the register controlling this element is PSW1 (and so on)
	Recipe transfer completion flag	The indicator lights up when the recipe transfer is completed

(12) Call function

Calling the C language function can complete more complex operations and communications.

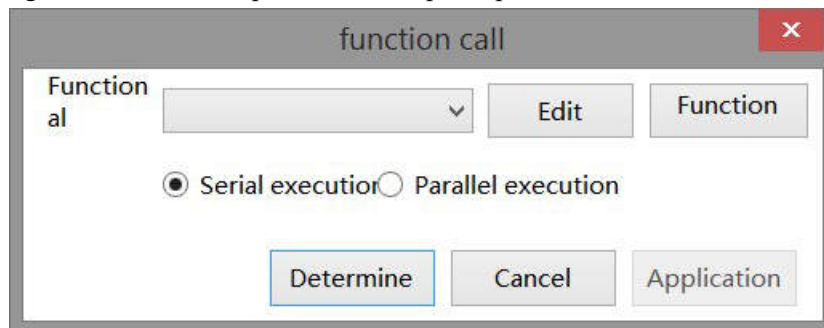

Function	Select the function to be called from the drop-down menu
Edit/function	Click to enter the function editing page
Serial execution	The next task can be done after the current task is completed. Therefore, this function must have appropriate exit conditions
Parallel execution	Call the task of this function, create a new task to execute the function, and the caller will continue the subsequent processing

(13)Screen printing

Print current information through printer.

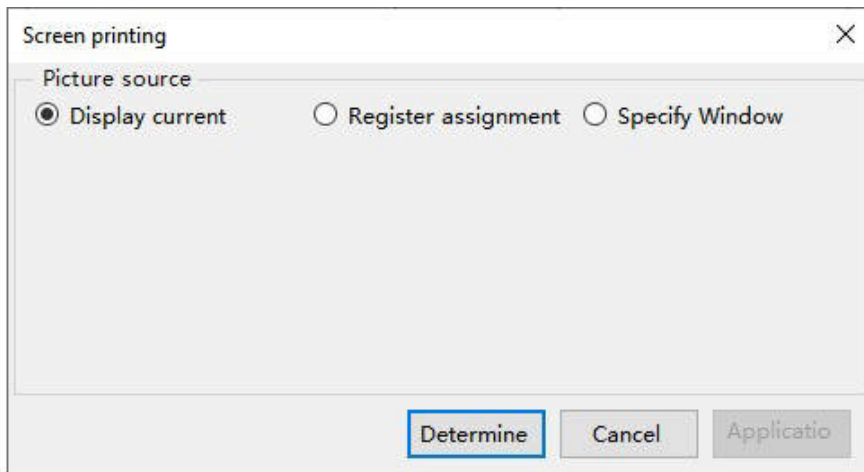

Picture source	Current display window, register specified, specified window
----------------	--

The connection and configuration of the printer are detailed in chapter 3-10-7 Printer.

■ Security setting



The bit limit can be set (the enabling state of the enable control can be customized). When the enabling condition is met, the component can be used normally (as shown in the figure above: when PSB0 is in the ON state and the trigger condition is met at the same time, the component can be used; if PSB0 is in the OFF state, the component is still unavailable even if the trigger condition is met).

■ Position

Same to chapter 4-1-1 straight line position part. (It is not allowed to modify the size and move horizontally and vertically).

4-2-17. Sliding input

The value can be displayed in the slider area, or the value in the set data address can be changed by dragging and sliding.

1. Click "Part/Input/Sliding Input" in the menu bar or  in the basic part bar of the control window, move the cursor to the screen, click the left mouse button to place it, click the right mouse button or click ESC to cancel the placement. Modify the control length and height through the boundary point.
2. When setting attributes, you can set them in the attribute box that pops up when placing components, or you can double-click "Sliding Input" or select "Sliding Input" and right-click, and then select "Attributes" to set attributes.

■ Basic property

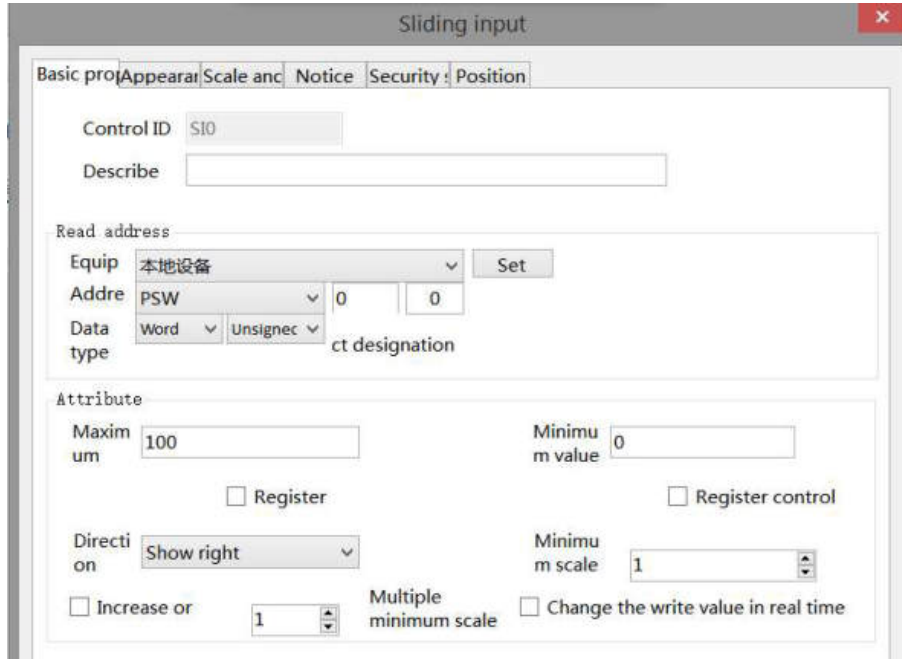

Control ID	It is used for system management component and cannot be operated by users
Describe	Can be used to comment on the purpose of this component
Read address	Set the register address, and set whether the address is offset (that is, specified indirectly)
Equipment	Current equipment port for communication
Address	Set target register number
Data type	Byte-8Bit, Word-16Bit, DWord- 32Bit, DDWord -64Bit, BCD format, Hex, Signed value, Unsigned value, Floating number
Set	Click "Set" to enter the address setting interface, where you can set and use system registers and user-defined tags. You can click the address tag library below or the project tree - library - address tag library to set the tags (see chapter 5-2 Address Tag Library for the use of address tag library and user-defined tags)
Indirect assignment	Set the current address offset. The current register address changes with the indirectly specified register value, that is, $Dx[Dy]=D[x+Dy \text{ value}]$ ($x, y=0, 1, 2, 3\dots$). For example: the current register address is PSW0, if the indirectly specified address is PSW100; When the value of PSW100 register is 0, the register controlling this element is still PSW0; When the value of PSW100 register is 1, the register controlling this

		element is PSW1 (and so on)
Property	Maximum	The upper limit value of the sliding input display value can be set as a constant or set through the register
	Minimum	The lower limit value of the sliding input display value can be set as a constant or set through the register
	Direction	Set the sliding direction, including up, down, left and right
	Minimum scale	The smallest numeric unit to increment or decrement when dragging the slider
	Increase or decrease the minimum scale per click	You can set the change size of the value each time you move the slider
	Change the write value in real time during sliding	If checked, the value in the corresponding register will change in real time as the slider is dragged. If not checked, the value in the corresponding register will not change in real time during the slider dragging process

■ Appearance

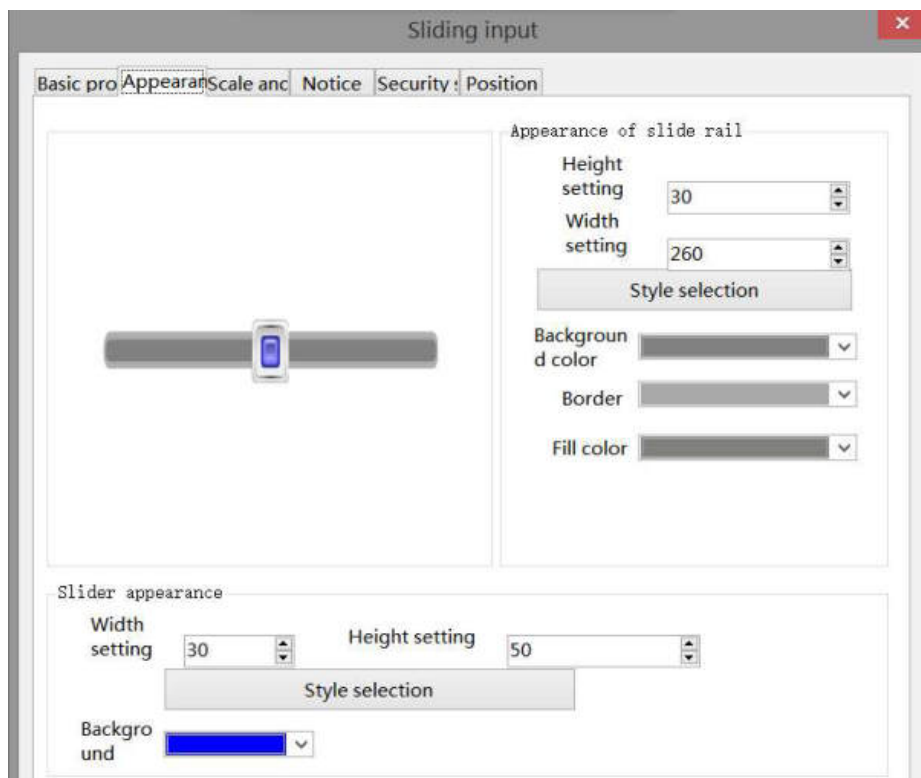

Appearance of slide rail	Set the height, width, style and color of the slide rail (when modifying, you can observe the modification results in the left preview in real time)
Slider appearance	Set the height, width, style and color of the slider (when modifying, you can observe the modification results in the left preview in real time)

■ Scale and mark

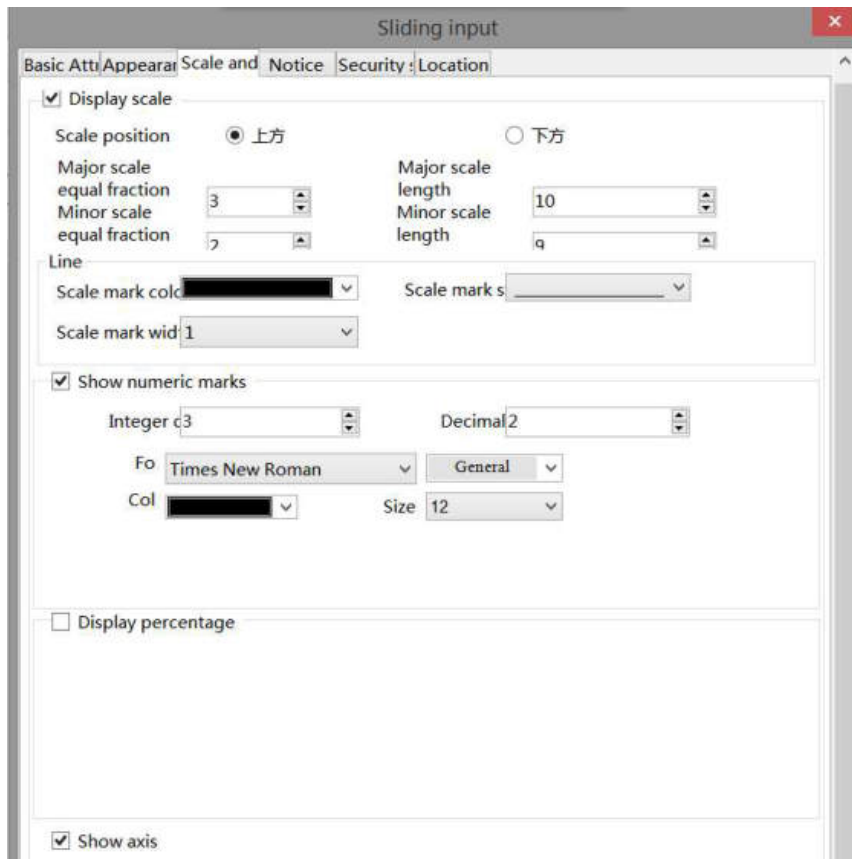

Display scale	If checked, scale will be displayed; if unchecked, scale will not be displayed
Scale position	Set the scale display position, which can be displayed above or below the slider
Scale	Set the number and length of major and minor scales
Line	Set the color, style, and width of tick marks
Show numeric markers/display percentage	Set the display format of the scale mark. Choose one of the two display methods
Show numeric markers	You can set the number of integer and decimal digits of the displayed number, and whether the font, size, color, font style and horizontal and vertical directions are aligned
Display percentage	You can set the font, size, color, font style, horizontal and vertical alignment of the displayed percentage
Display axis	Set whether the axis is displayed at the bottom of the scale

■ Notice

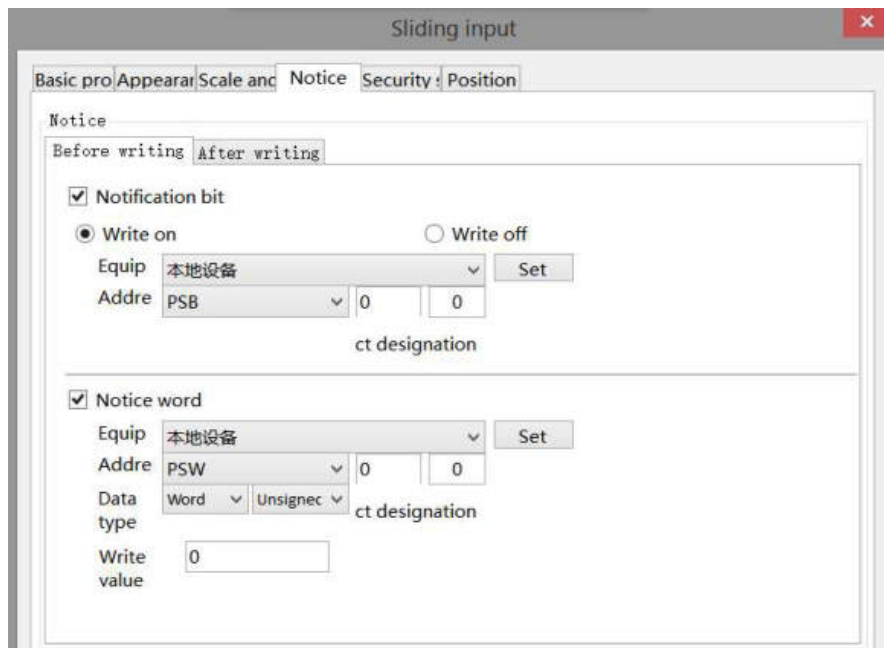

Notice	If notification bit or notice word is enabled, you can select to write the target coil ON, OFF or the target register to a constant before or after writing. If not enable them, the notification function will not take effect
--------	---

■ Security setting

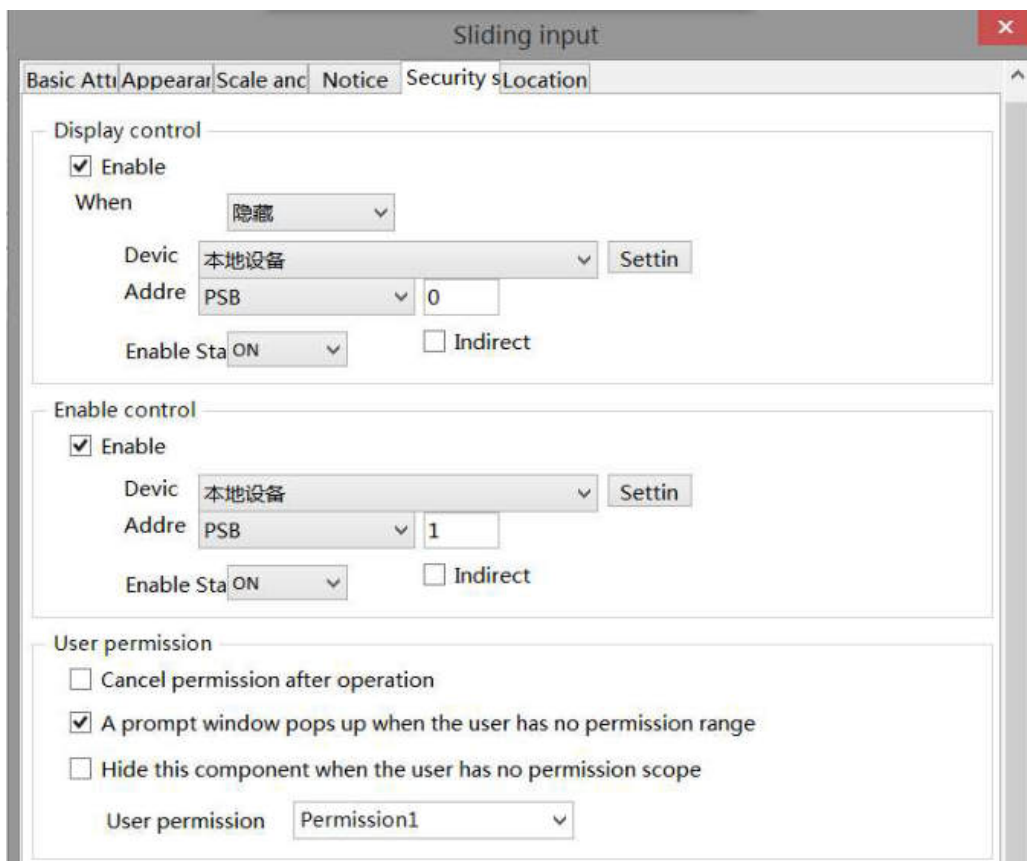

display control	Use bit to control whether to display the part, and hide the part when the condition is not met
enable	When checked, display control will be enabled
When validation fails	Set the display of this part when validation fails
device	The equipment port for current communication

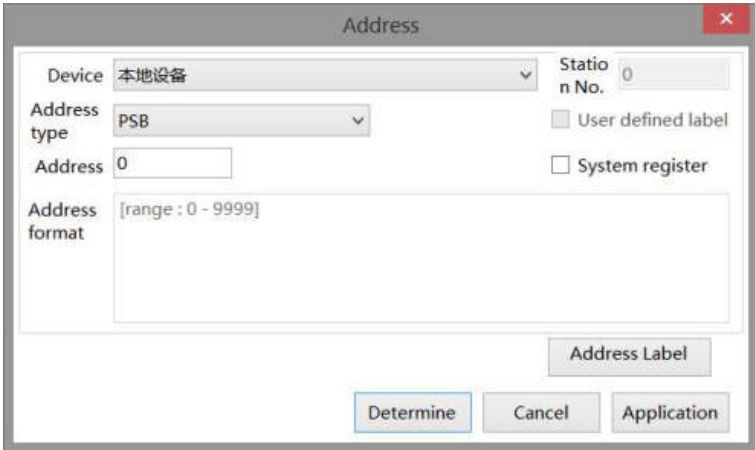
address	Set the target coil for bit control
setting	<p>Click "Setting" to enter the address setting interface, where you can set the use of system registers and user-defined tags. You can click the address tag library or project tree-library-address tag library below to set the used tags (see 5-2 Address tag library for the use of address tag library and user-defined tags)</p> 
enable state	<p>Set the ON status to be valid or the OFF status to be valid.</p> <p>For example, if the device is checked as shown in the figure above, the bit control is PSB0, the selection is hidden when the verification fails, and the enable status is ON, then when the PSB0 status is ON, the component is normally displayed, and when the PSB0 status is OFF, the component is hidden and not displayed.</p>
enable control	<p>The bit limit can be set (the enabling state of the enable control can be customized). Only when the enabling conditions are met can the component be used normally (as shown in the figure above: When the PSB1 is in the ON state and the trigger conditions are met, the component can be used; if the PSB1 is in the OFF state, even if the trigger condition is met, the component is still unavailable)</p>
user permission	<p>Set a controlled permission level. After setting the permission range of the required user, the following two functions can be checked as required:</p> <ol style="list-style-type: none"> (1) After the operation is completed, the user's permission will be cancelled: If this option is not checked, the corresponding level password will need to be entered each time the component is operated. After checking, only one successful entry is required. (2) When the user has no permission range, a prompt window will pop up. (3) Hide the component when the user has no permission range.



Refer to chapter 4-2-3 for the use of permission functions.

■ Location

Same to location part of chapter 4-1-1 straight line.



4-2-18. Drop down menu

Call the pull-down window, click the selected key to set the register value, and close the pull-down window.

1. Click the menu "Parts/Key/Dropdown Menu" or the drop-down menu icon in control window's basic parts bar "", move the cursor to the screen, click the left mouse button to place, click the right mouse button, or use the ESC key to cancel the placement. Modify the length and width of the component through boundary points.
2. When setting attributes, you can set them in the attribute box that pops up when placing components, or you can double-click the "drop-down menu" or select the "drop-down menu" and right-click to select "basic attribute" for attribute settings.

■ Basic attribute

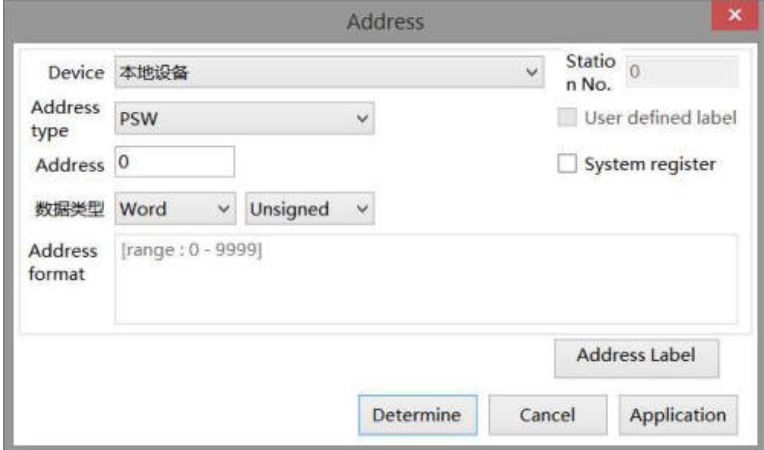
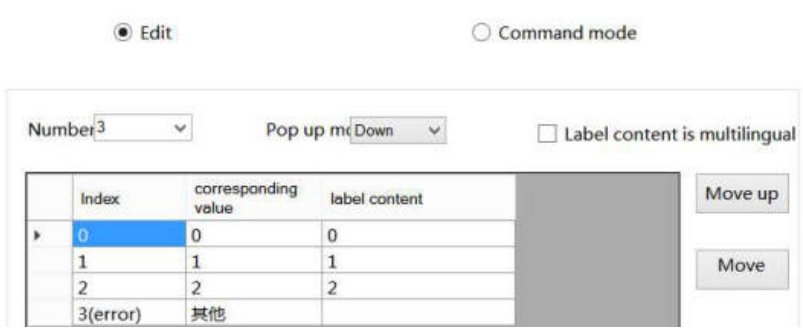
control ID	It is used for system management control, and cannot be operated by users			
description	Can be used to comment on the purpose of this control object			
mode	<p>two modes: drop down menu, list box style</p> <p>drop down menu: click to show all the options</p> <p>list box style: it can show all the options without clicking</p> <div style="display: flex; justify-content: space-around; align-items: center;"> <div style="text-align: center;">  <p>drop down menu</p> </div> <div style="text-align: center;"> <table border="1" style="border-collapse: collapse;"> <tr><td>0</td></tr> <tr><td>1</td></tr> <tr><td>2</td></tr> </table> <p>list box style</p> </div> </div>	0	1	2
0				
1				
2				

read address	Set the register address and set whether to offset the address (i.e. indirectly specify)
device	Device port currently communicating
address	Set target register number
data type	Byte-8Bit; Word-16Bit; DWord- 32Bit; DDWord -64Bit; BCD; Hex; Signed; Unsigned; Floating number
setting	<p>Click "Settings" to enter the address setting interface. This interface allows you to set and use system registers and user-defined tags. You can click the address tag library or project tree library address tag library below to set the tags used (see 5-2 Address Tag Library for the use of address tag library and user-defined tags)</p> 
indirect designation	Set the current address offset. The current register address changes as the indirectly specified register value changes, that is, $Dx [Dy]=D [x+Dy \text{ value}]$ ($x, y=0, 1, 2, 3\dots$). Example: The current register address is PSW0, if the indirectly specified address is PSW100; When the value of the PSW100 register is 0, the register that controls this component remains PSW0; When the value of the PSW100 register is 1, the register that controls this component is PSW1 (and so on)
edit	<p>That is, determine the setting value and text corresponding to each drop-down option through the register address</p> 
number	Set the number of drop-down options (1-255)
pop up mode	Set the pop-up method for drop-down options, which can be selected from up or down. This item cannot be set when the above mode is selected as "List Box"
index	The serial number of the drop-down option, which is not displayed in the control when actually used
corresponding value	The register setting value corresponding to the current option which is not displayed in the control during actual use
label content	The text description displayed above the option can be modified by double clicking
label content is multilingual	selected this item, click the label content, then click the  to set multi-language. Or manage it in the project tree - Library - Label Multilingual - on the left of the project interface (see 5-1 Label Multilingual for specific usage)

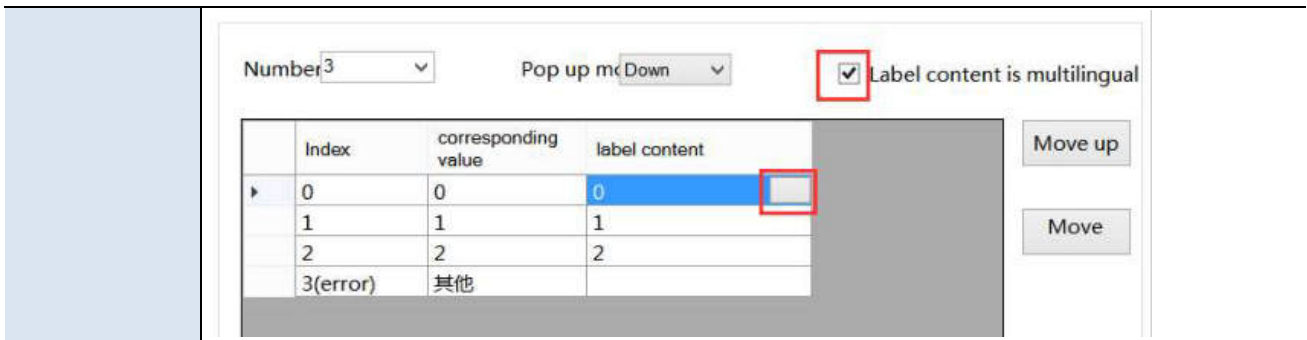

move up Move the specified option up

move down Move the specified option down

command mode After selecting the command mode, the control will display the user list set in System Settings - User Permissions, and the read address above will also become gray and cannot be set; Note that this item is only for display purposes and does not affect the use of operating permissions

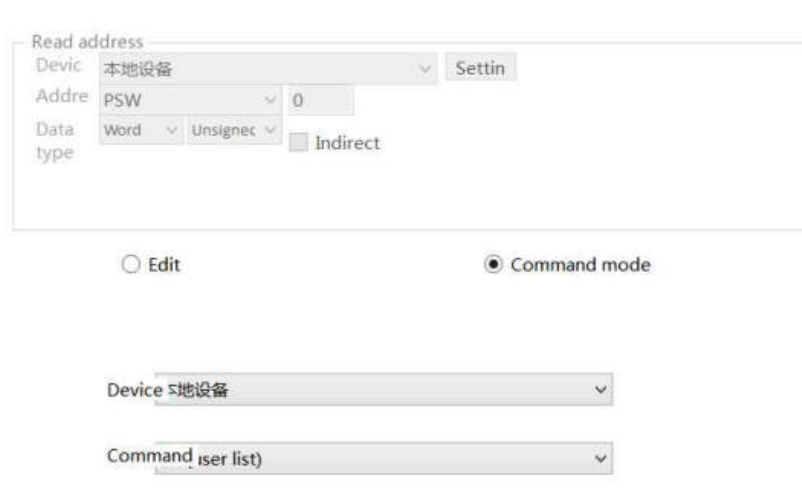

■ Appearance

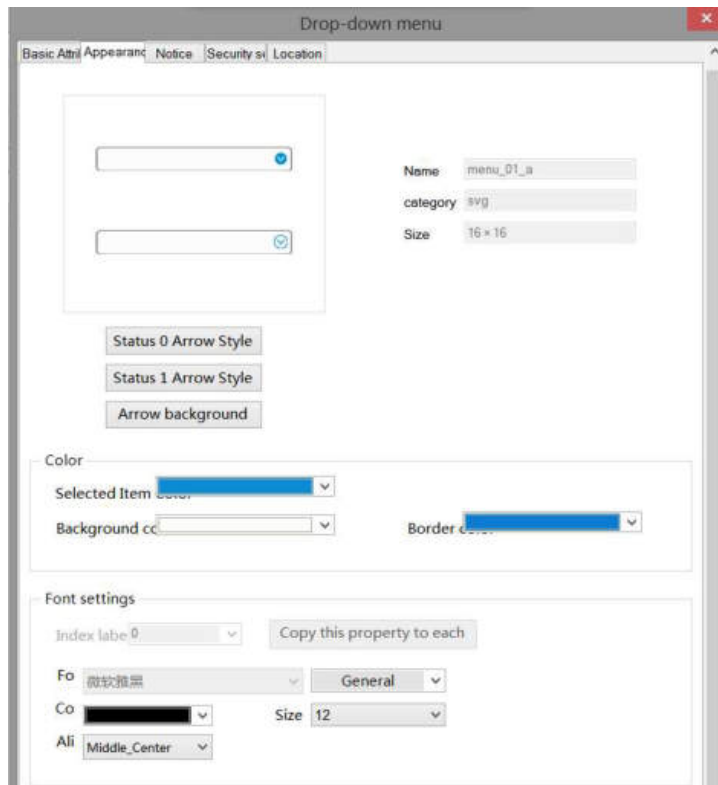

status 0 arrow style	Select the appropriate arrow style in the gallery
status 1 arrow style	Select the appropriate arrow style in the gallery
arrow back ground	Select the appropriate arrow background style in the gallery
color	You can set the color, background color, and border color of the selected item
font settings	"You can set the font, font style, size, font style, color, and display position of the font in the control through the number of the drop-down index label (you can click "Copy this property to each" to format the font in all states)"

■ Notice

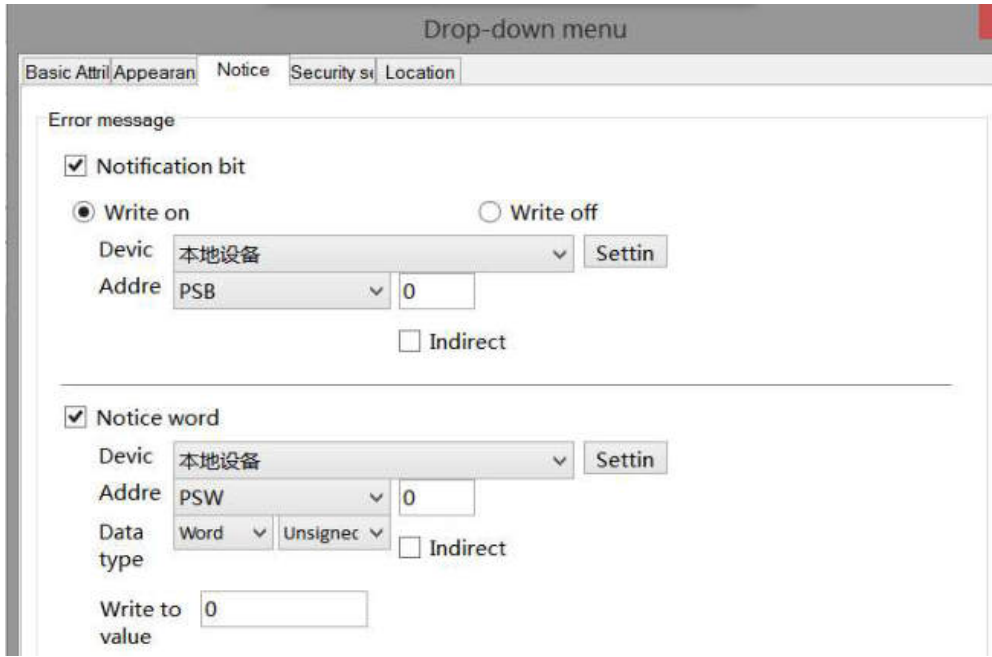

error message If Enable is checked, when the value of the read address is an unset corresponding value (that is, other numbers that are not set to 0, 11, 22, 33, and 4), it will write ON or OFF to the target coil or write a constant to the target register; If Enable is not checked, the notification function will not take effect

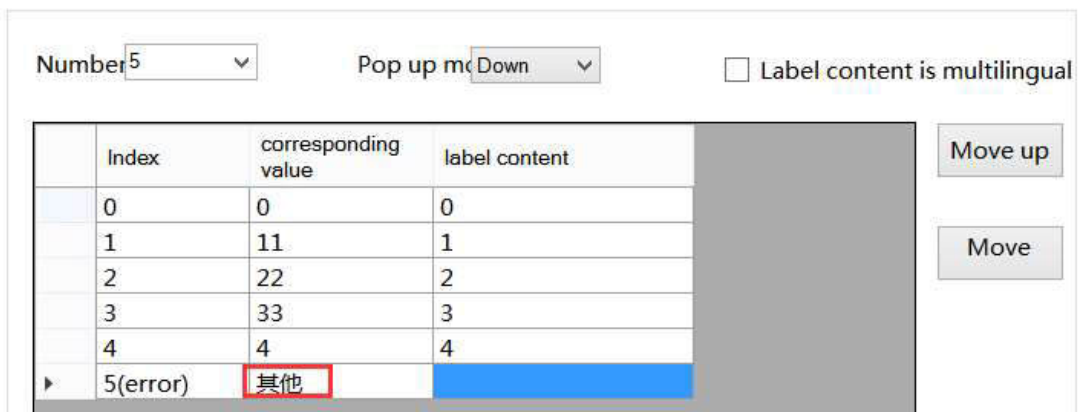

■ Security setting

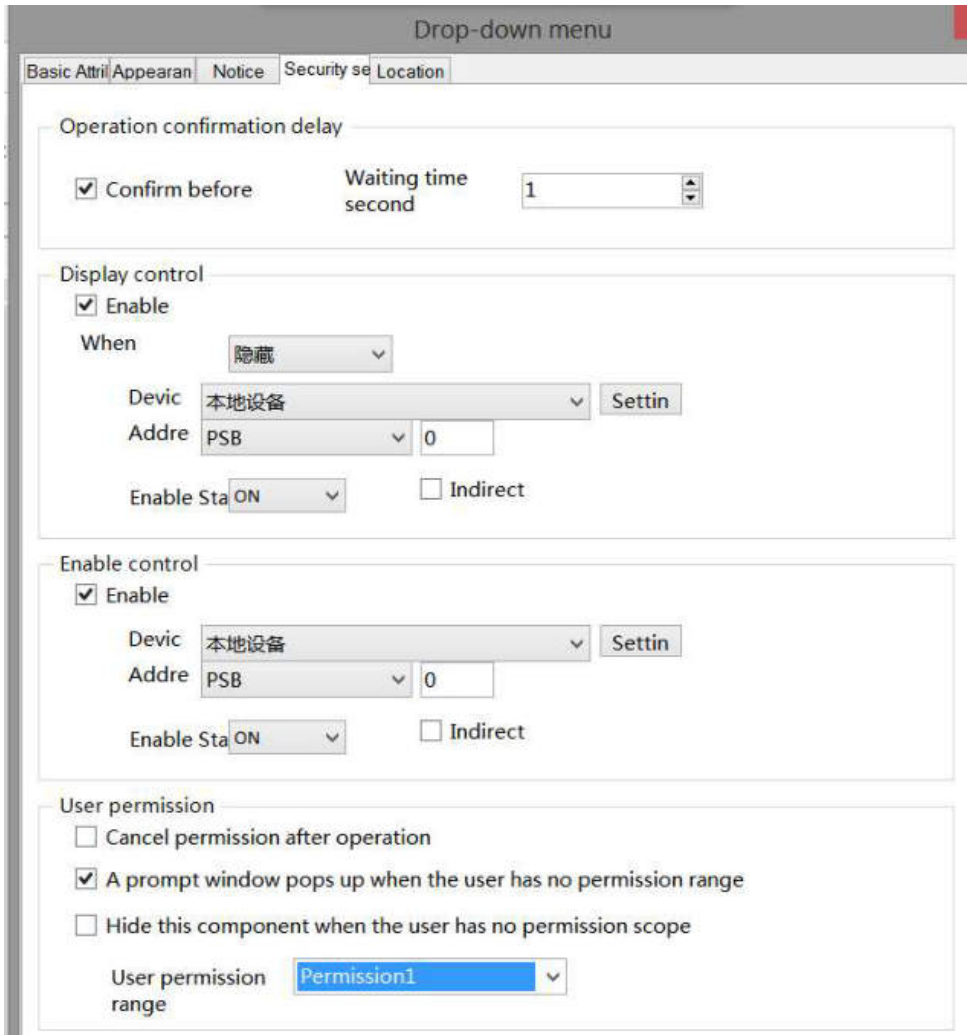

Same to the security setting part of chapter 4-2-3. numerical input.

■ Location

Same to location part of chapter 4-1-1 straight line.

4-2-19. File browse

Used to display files in the USB drive.



1. Click on the file browsing icon  in the basic components bar of the control window, move the cursor to the screen, click the left mouse button to place, click the right mouse button or use the ESC key to cancel the placement. Modify the length and width of the control through boundary points.

2. When setting attributes, you can set them in the attribute box that pops up when placing components. You can also double-click "File Browser" or select "File Browser" and right-click to select "Properties" for attribute settings.

■ Basic property

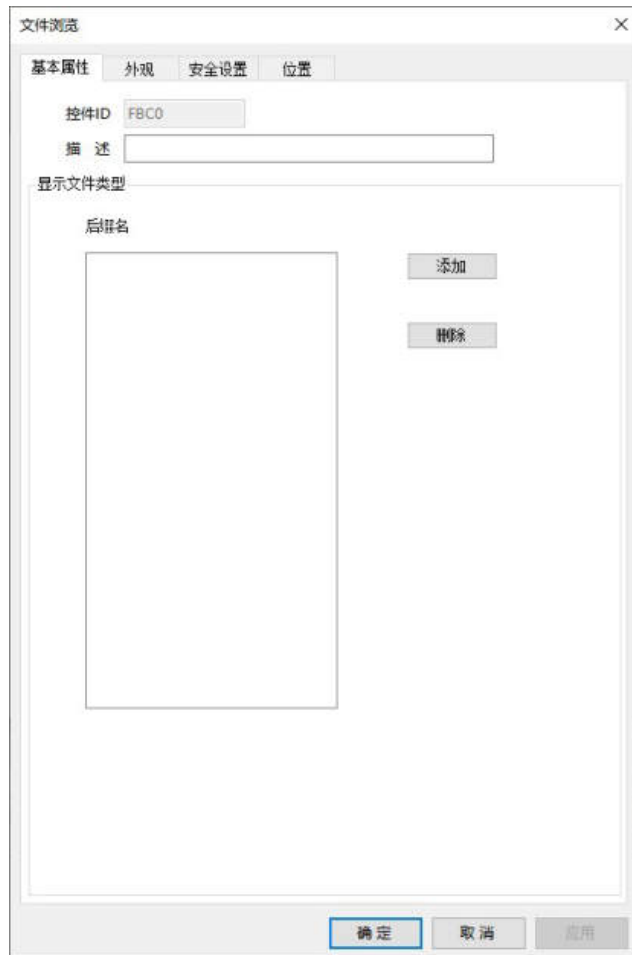

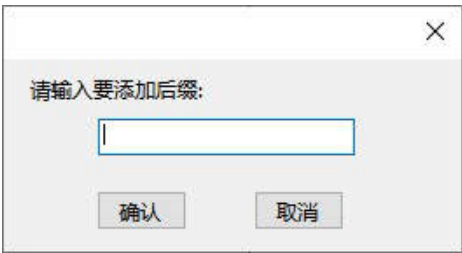
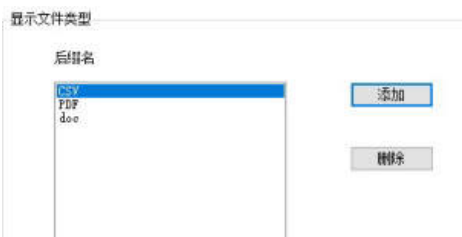
Control ID	Used for system management controls, user cannot operate.
Description	Can be used to annotate the purpose of this control.
Display file type	<p>You can click the "Add" button to add the file extension name that needs to be displayed, which includes but is not limited to PDF, CSV, doc, etc.</p>  <p>The left list can display the added suffix names</p>  <p>Click the "Delete" button to delete suffix rows that do not need to be displayed in the list</p>

■ Appearance



Color	The background color of the control and the color of the selected item can be set.
Font	The font, glyph, size, color, and alignment can be set by using the numbers on the dropdown index label (you can click "Copy this property to each state" to format the font for all states).

- Security setting

Same as chapter 4-2-3. Numerical input in the safety settings section.

- Location

Same as chapter 4-1-1. Straight line location part.

4-3. Device

The device bar includes: time, date, pipe, dashboard, motor, bar chart, buzzer, backlight, fan, mixer, water pump, and valve.

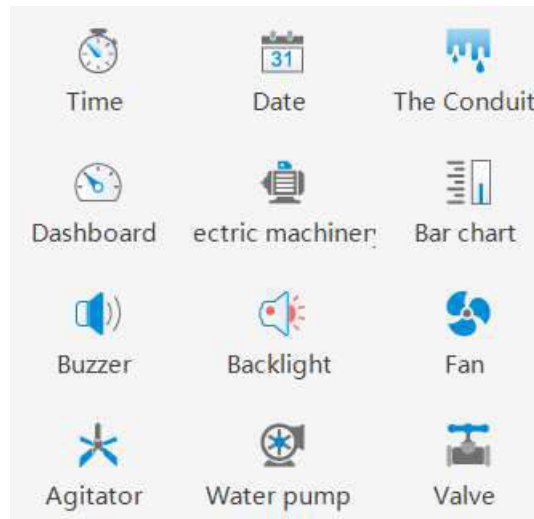

4-3-1. Time

This control is used to display the current time of the HMI.

1. Click the "🕒" time icon in the the control window's device bar or menu bar "Parts/Industry/Time", move the cursor to the screen, click the left mouse button to place, click the right mouse button, or click ESC to cancel the placement. Modify the length and width of the border through boundary points.
2. When setting attributes, you can set them in the attribute box that pops up when placing components, or you can double-click "Time" or select "Time" and then right-click and select "attributes" to set attributes.

■ Basic attribute

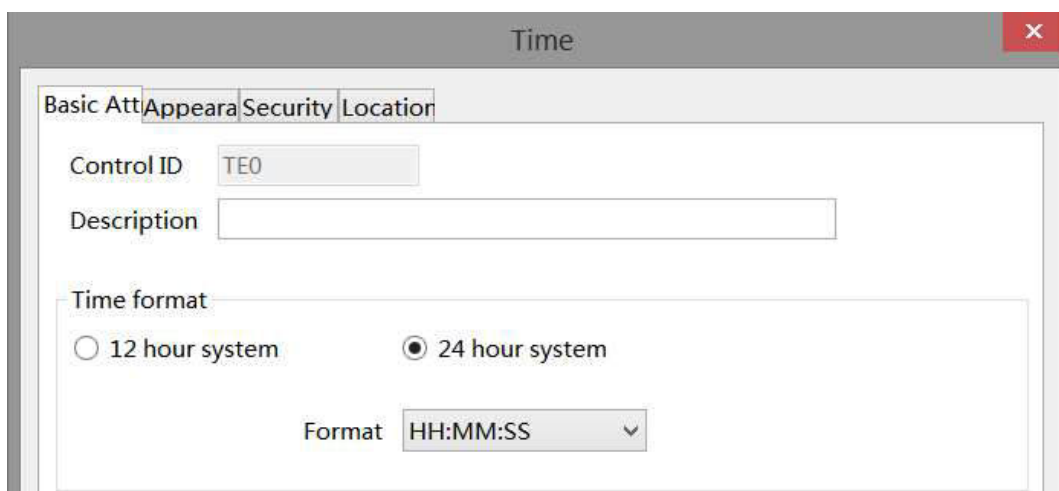

control ID	It is used for system management control, and cannot be operated by users
description	Can be used to comment on the purpose of this control
time format	Set the time format, including "12 hour system" and "24 hour system", with 4 formats available

■ Appearance

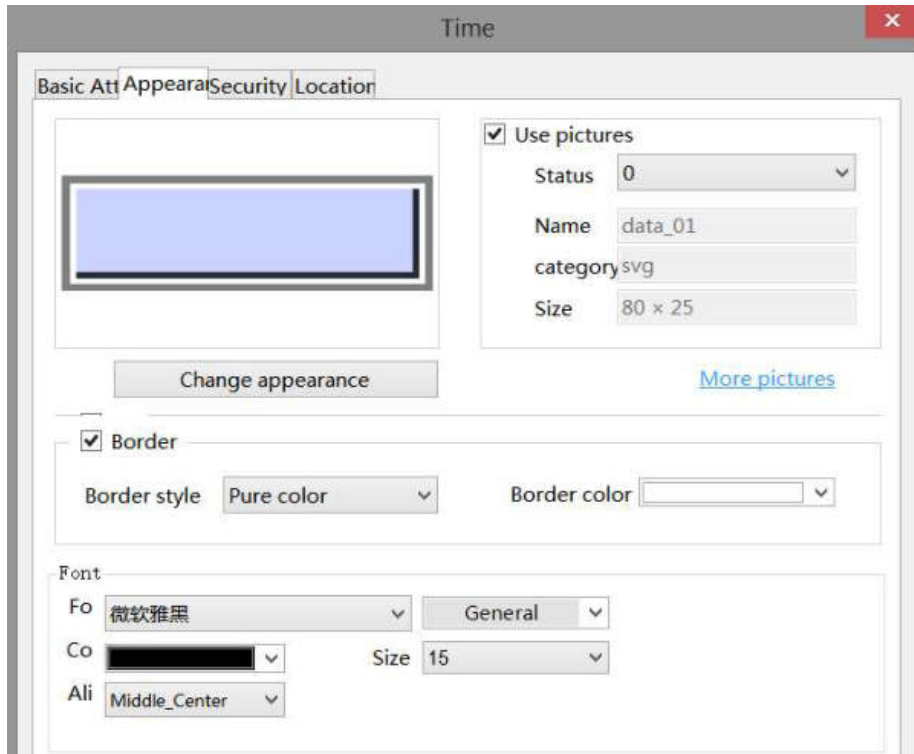

appearance	To set the display appearance, click "Change Appearance" or "More Pictures" to make changes
use pictures	Set whether to use pictures
fill	Set the fill color and fill style for the appearance (solid/gradient)
border	Set the fill color and fill style of the border (solid/gradient)
font	Set scale font, color, size, and alignment

■ Security setting

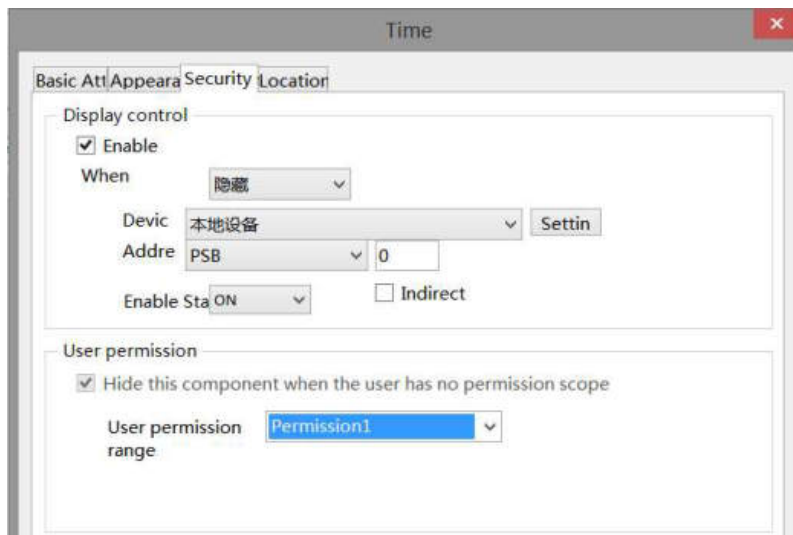

Same to chapter 4-1-1 straight line security setting part.

■ Location

Same to chapter 4-1-1 straight line location part.

4-3-2. Date

This control is used to display the current date (year month day) of the touch screen.

1. Click the date icon in the menu bar "Parts/Industry/Date" or  in the control window, move the cursor to the screen, click the left mouse button to place, click the right mouse button, or click ESC to cancel the placement. Modify the length and width of the border through boundary points.
2. When setting attributes, you can set them in the attribute box that pops up when placing components, or you can double-click "Date" or select "Date" and right-click to select "attributes" to set attributes.

■ Basic attributes

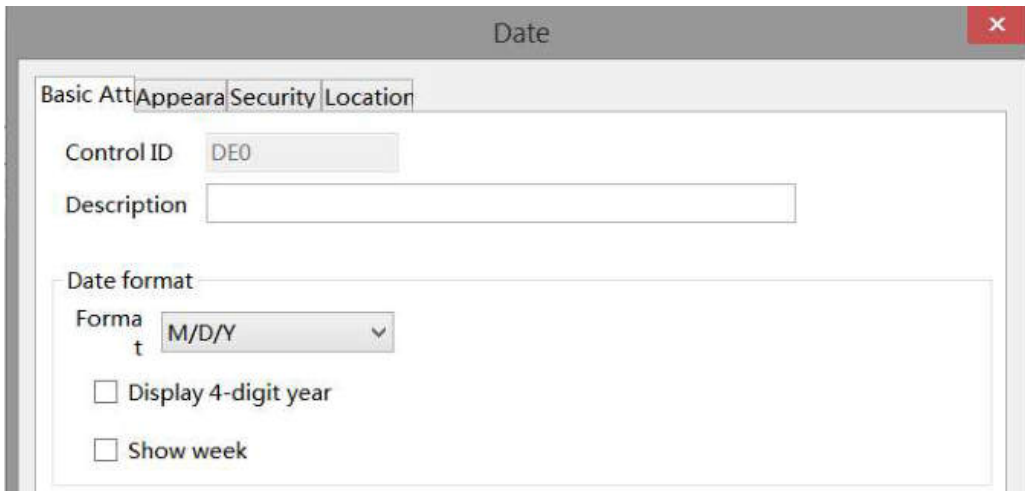

control ID		It is used for system management control, and cannot be operated by users
description		Can be used to comment on the purpose of this control
date format	format	set the date format
	display 4-digit year	Set whether to display a 4-digit year
	show week	Set whether to display the week

■ Appearance

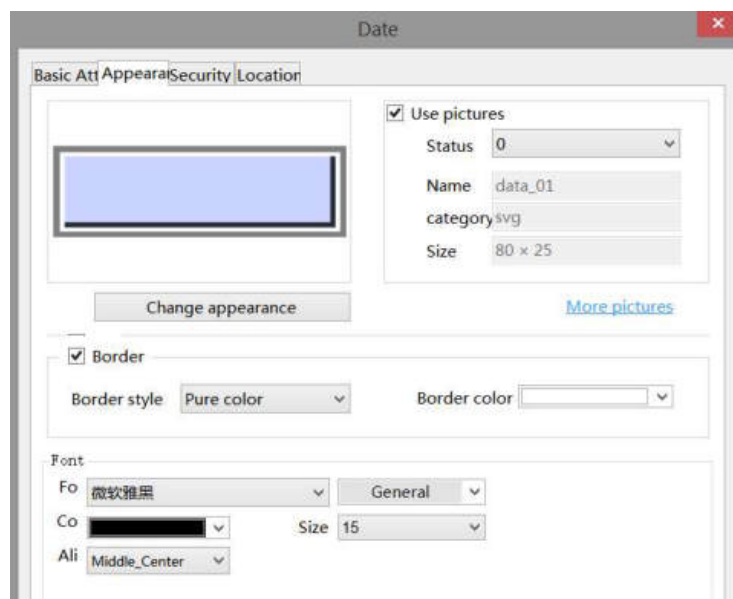

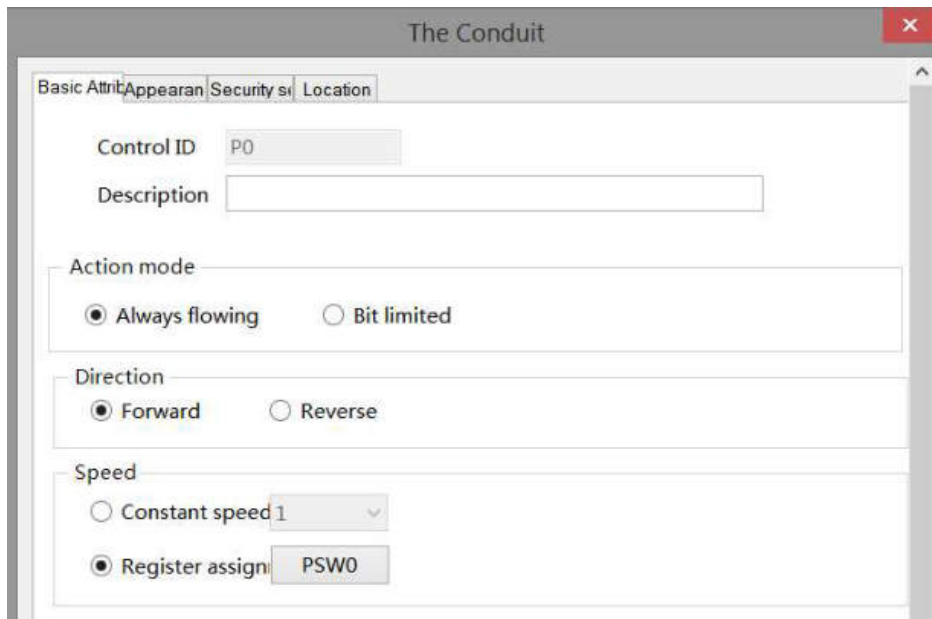

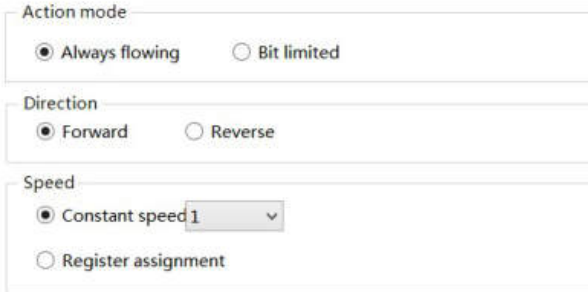
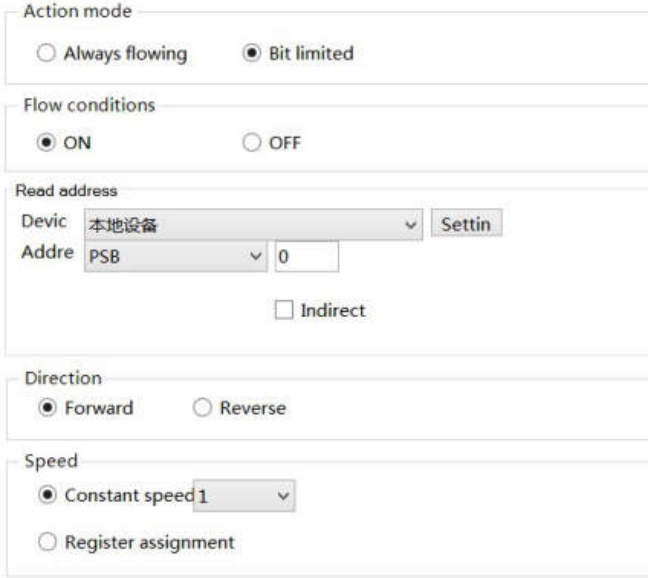
control ID	It is used for system management control, and cannot be operated by users
description	Can be used to comment on the purpose of this control
action mode	Set the action mode of the fluid, including always flow and bit limited
always flowing	<p>the fluid will always flow</p> 
bit limited	<p>When the flow conditions are met, the fluid will flow (as shown in the figure below, when PSB0 is ON, the fluid will flow forward)</p> 
device	Device port currently communicating
address	Set target coil number

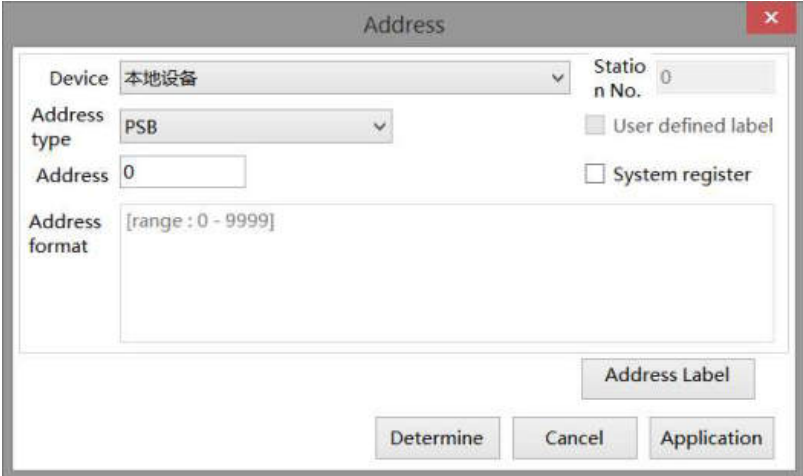
setting	<p>Click "Settings" to enter the address setting interface. This interface allows you to set and use system registers and user-defined tags. You can click the address tag library or project tree - library - address tag library below to set the tags used (see 5-2 Address Tag Library for the use of address tag library and user-defined tags)</p> 
Indirect designation	<p>Set the current address offset. The current coil address changes with the indirectly specified register value, that is, Dx [Dy]=D [x+Dy value] (x, y=0, 1, 2, 3...). Example: The current coil address is PSB0, if the indirectly specified address is PSW100; When the value of the PSW100 register is 0, the coil that controls this element remains PSB0; When the value of the PSW100 register is 1, the coil that controls this element is PSB1 (and so on)</p>
flow condition	<p>Select the action mode of the fluid to be ON or OFF (only available when bit limited)</p>
read address	<p>Set the controlled coil address and set whether there is an offset (this option is only available when bit limited)</p>
direction	<p>Set the flow direction of the fluid, including forward and reverse directions</p>
speed	<p>Set the flow speed of the fluid. You can manually set a constant speed or set a register to control the speed. (When the speed set in the register is "0, flow at the lowest speed of 1, when set to 25, flow at the highest speed of 25.)</p>

■ Appearance

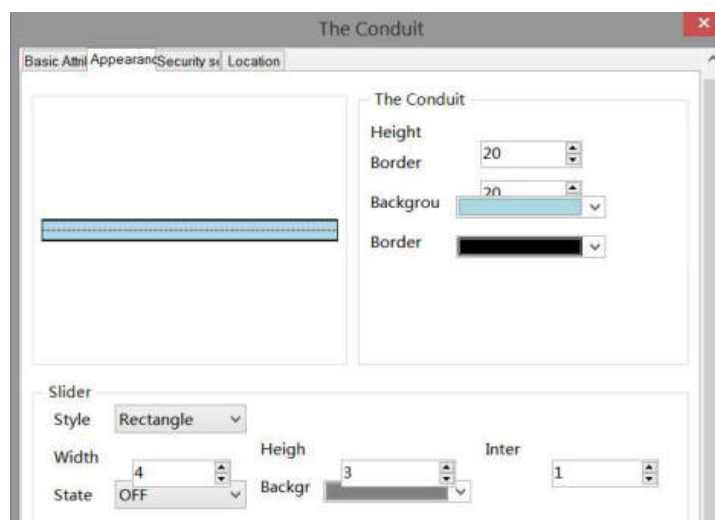

the conduit	height	Set the height of the pipe
	border (%)	Set the border width ratio of the pipe
	background	Set the background color of the pipe
	border	Set the color of the pipe periphery
slider	style	Set the style of the slider, including rectangles and arrows
	width	Set the width of the slider
	height	Set the height of the slider
	space	Set the interval of the slider
	state	Set the slider in two states: ON or OFF
	background	Set the color of the slider in both ON/OFF states



$$=(\text{height} * \text{border width} \%) / 2.$$

■ Security setting

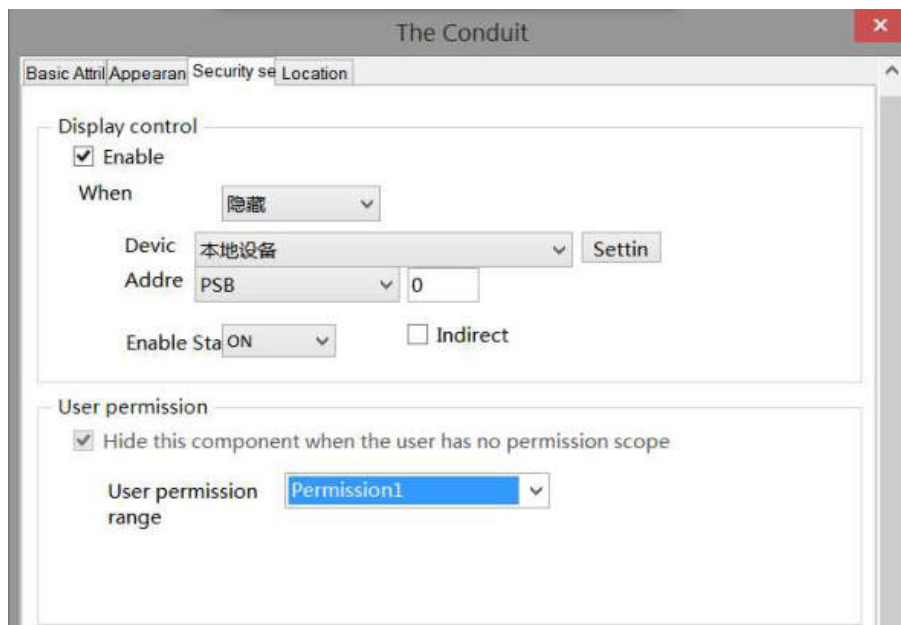

Same to chapter 4-1-1 straight line security setting part.

■ Location

Same to chapter 4-1-1 straight line location part.

4-3-4. Dashboard

This control is used to display the meter.

1. Click the dashboard icon in the menu bar "Parts/Industry/Dashboard" or  in the device bar of the control window, move the cursor to the screen, click the left mouse button to place, click the right mouse button, or click ESC to cancel the placement. Modify the length and width of the border through boundary points.
2. When setting attributes, you can set them in the attribute box that pops up when placing components. You can also double-click "Dashboard" or select "Dashboard" and right-click to select "attributes" to set attributes.

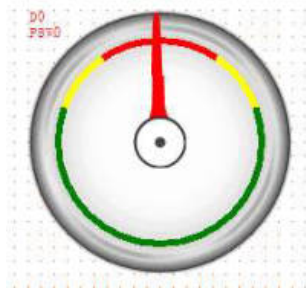

■ Basic attributes

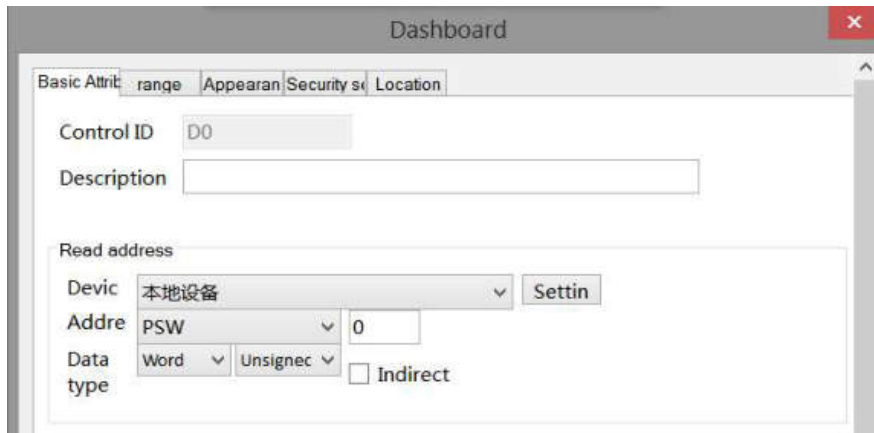

control ID	It is used for system management control, and cannot be operated by users	
description	Can be used to comment on the purpose of this control	
read address	device	Select the device port currently communicating with
	setting	Click "Setting" to enter the address setting interface. This interface allows you to set and use system registers and user-defined tags. You can click the address tag library or project tree – library - address tag library below to set the tags used (see 5-2 Address Tag Library for the use of address tag library and user-defined tags)
	address	Set the monitoring address of the instrument, and set whether to offset the address (i.e. indirectly specify)
	data type	Byte-8Bit; Word-16Bit; DWord- 32Bit; DDWord -64Bit; BCD; Hex format; Signed; Unsigned; Floating number
indirect specify	Set the current address offset. The current register address changes as the indirectly specified register value changes, that is, $Dx [Dy]=D [x+Dy \text{ value}]$ ($x, y=0, 1, 2, 3\dots$). Example: The current register address is PSW0, if the indirectly specified address is	

		PSW100; When the value of the PSW100 register is 0, the register that controls this component remains PSW0; When the value of the PSW100 register is 1, the register that controls this component is PSW1 (and so on)
--	--	---

■ Range

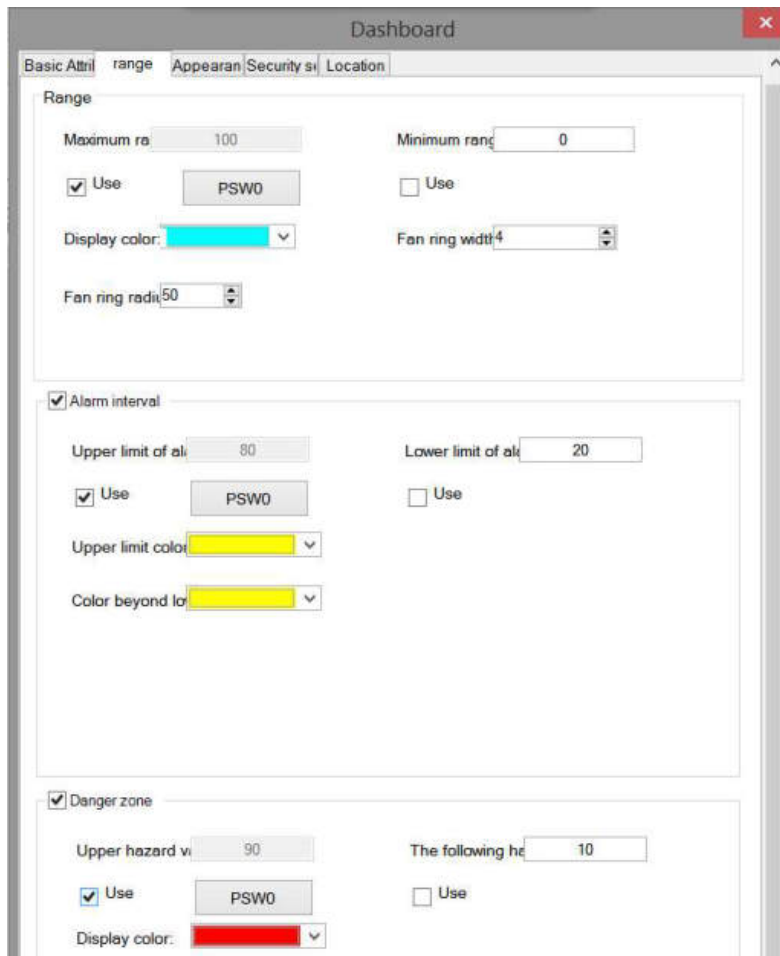

range	max range	Set the maximum value of the instrument. You can set a constant or choose to use register control
	min range	Set the minimum value of the instrument. You can set a constant or choose to use register control
	display color	Set the display color of the meter
	fan ring width	Set the fan ring width for the meter display
	fan ring radius	Set the fan ring radius for the instrument display
alarm interval	upper limit of alarm	Set the maximum alarm value of the instrument. You can set a constant or choose to use register control
	lower limit of alarm	Set the minimum alarm value of the instrument. You can set a constant or choose to use register control
	upper limit color	Set the color exceeding the upper limit, which will be displayed when the reading value of the instrument exceeds the upper limit value
	color beyond lower limit	Set the color exceeding the lower limit, which will be displayed when the reading value of the instrument exceeds the lower limit value
danger zone	upper hazard value	Set the maximum dangerous value of the instrument. You can set a constant or choose to use register control
	lower hazard	Set the minimum dangerous value of the instrument, which can be set as a constant

	value	or controlled by registers
	display color	Set the color of the danger range, and display the set color when the reading value of the instrument register is within the danger range



The range of the danger zone should be greater than or equal to the range of the alarm zone. If equal, the color displays the color of the danger zone.

■ Appearance

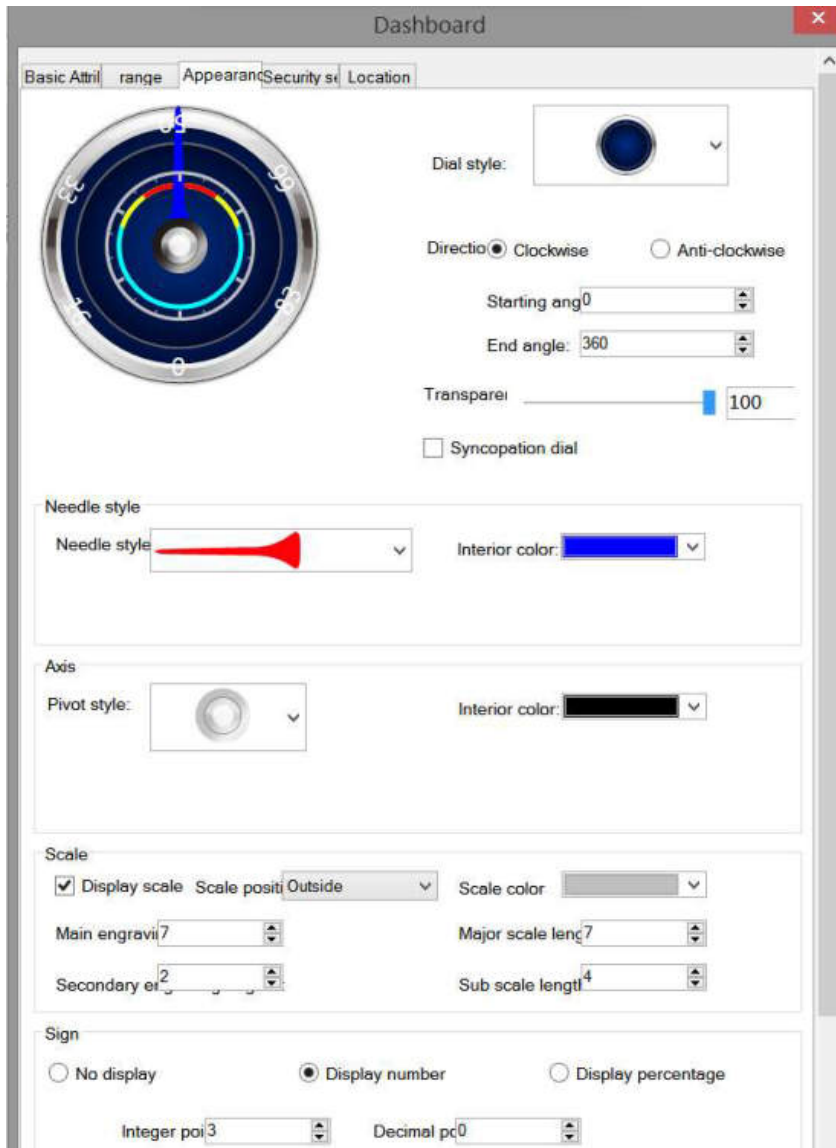

dial style	You can select a dial style in the drop-down box
direction	Set the direction indicated by the needle, clockwise or counterclockwise
starting angle	Set the starting angle of the meter (0°- 359°)
end angle	Set the ending angle of the meter (0°- 360°)
transparency	Set the transparency of the dial. (Tick off the syncopation dial to set the transparency.) You can complete the setting by sliding the slider. The closer the slider is to the left, the smaller the value, and the more transparent the component
syncopation dial	It is possible to cut off the dial that is not in the starting and ending angles

needle style	needle style	You can select a needle style in the drop-down box
	interior color	Set the internal color of the needle
axis	pivot style	You can select a pivot style in the drop-down box
	interior color	Set the interior color of the pivot
	external color	Set the outer frame color of the pivot
scale	display scale	Check to set whether to display the scale (if you check not to display the scale, the mark set below will not be displayed either)
	scale position	Set the position of the scale, including inside, outside, and center
	scale color	Set the color of the scale
	main scale division	Set the number of divisions for the main scale
	main scale length	set the main scale length
	subscale division	Set the number of divisions for the subscale
	subscale length	set the subscale length
sign	no display	When checked, no numbers or percentages will be displayed on the instrument
	display number	When checked, the number is displayed on the instrument
	display percentage	When checked, the percentage is displayed on the instrument
	integer position	Set the integer digits of the display number (valid when marked as "Display Number" or "Display Percentage")
	decimal position	Set the decimal places for displaying numbers (valid when marked with "Display Numbers" or "Display Percentage")
	font	Set the font, color, and size of the displayed numbers (valid when marked as "Display Numbers" or "Display Percentage")

■ Security setting

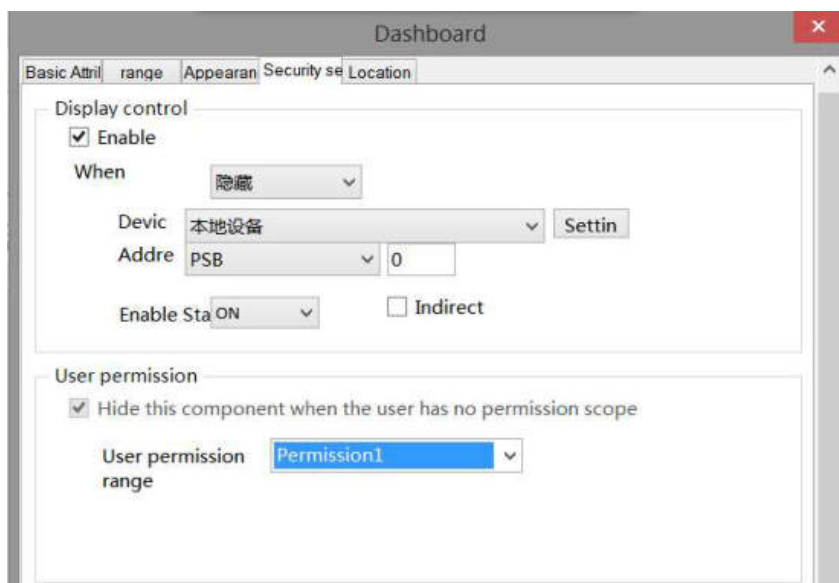

Same to chapter 4-1-1 straight line security setting part.

■ Location

Same to chapter 4-1-1 straight line location part.

4-3-5. Electric machinery

This control can be used to simulate the operation process of the motor. When the controlled coil reaches the specified state, the motor can display the corresponding state.

1. Click the icon in the menu bar "Parts/Industry/Motors" or  in the control window's device bar, move the cursor to the screen, click the left mouse button to place, click the right mouse button, or use the ESC key to cancel the placement. Modify the length and width of the border through boundary points.
2. When setting attributes, you can set them in the attribute box that pops up when placing components, or you can double-click "Motor" or select "Motor" and right-click to select "attributes" for attribute settings.



■ Basic attributes

control ID	It is used for system management control, and cannot be operated by users
description	Can be used to comment on the purpose of this control
read address	Set the coil address of the control motor and set whether there is an offset (i.e. indirectly specified)
device	Select the device port currently communicating with
setting	Click "Settings" to enter the address setting interface. This interface allows you to set and use system registers and user-defined tags. You can click the address tag library or project tree - library - address tag library below to set the tags used (see 5-2 Address Tag Library for the use

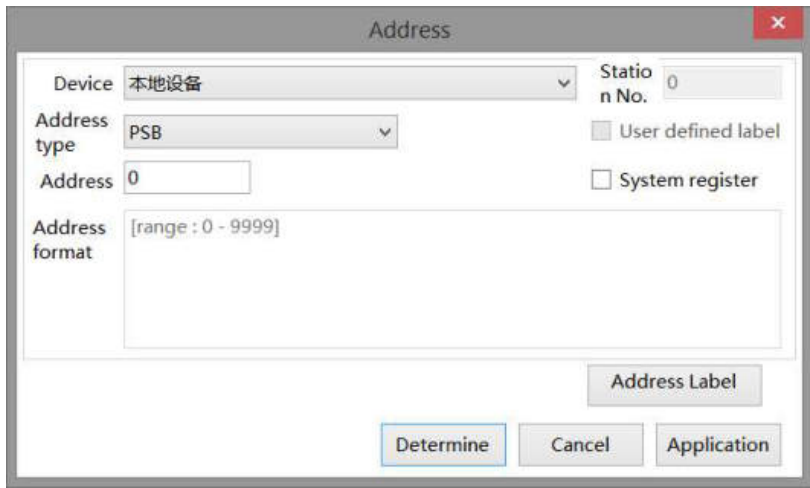
	of address tag library and user-defined tags)
	
address	Set the monitoring address of the motor and set whether the address is offset (i.e. indirectly specified)
indirect specify	Set the current address offset. The current register address changes as the indirectly specified register value changes, that is, $Dx [Dy]=D [x+Dy \text{ value}]$ ($x, y=0, 1, 2, 3\dots$). Example: The current register address is PSW0, if the indirectly specified address is PSW100; When the value of the PSW100 register is 0, the register that controls this component remains PSW0; When the value of the PSW100 register is 1, the register that controls this component is PSW1 (and so on)
logic	Select positive or negative logic when displaying motor status
flash	Select whether to blink and whether to blink in a certain state, such as ON state flashing and OFF state flashing
flicker frequency	Set the frequency of blinking

■ Appearance

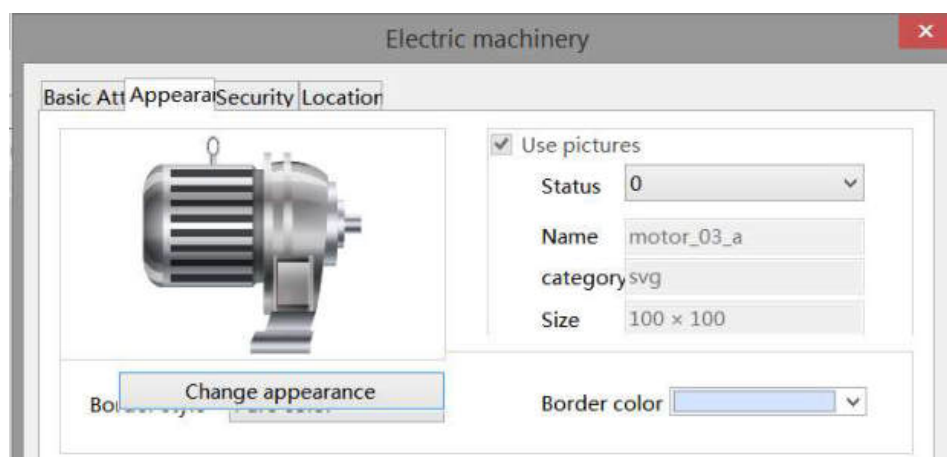

change appearance	Set display appearance
use pictures	Set whether to use pictures. You can set the appearance of clicking in two states: (0, 1). After selecting the state in the upper right corner, click "Change Appearance" or click "More Pictures" to select custom images to change the appearance
border	Set border style and color

■ Security setting

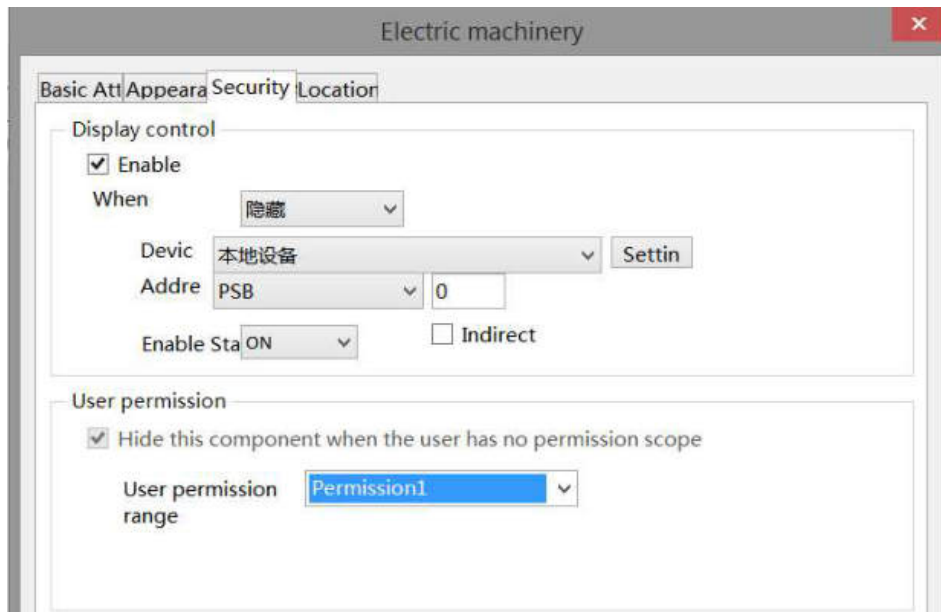

Same to chapter 4-1-1 straight line security setting part.

■ Location

Same to chapter 4-1-1 straight line location part.

4-3-6. Bar chart

This control is used to achieve the target object data value, represented by a bar graph, and is more direct. It is usually applied to analog quantities such as pressure changes, liquid level changes, and temperature changes, and can directly reflect the relationship between the current value and the full scale value:

1. Click the bar graph icon in the menu bar "Parts/Industry/Bar chart" or  in the device bar of the control window, move the cursor to the screen, click the left mouse button to place, click the right mouse button, or click ESC to cancel the placement. Modify the length and width of the border through boundary points.
2. When setting attributes, you can set them in the attribute box that pops up when placing components, or you can double-click on "Bar Chart" or select "Bar Chart" and right-click to select "Attributes" for attribute settings.

■ Basic attributes



control ID	It is used for system management control, and cannot be operated by users	
description	Can be used to comment on the purpose of this control	
read address	device	Select the device port currently communicating with
	setting	Click "Settings" to enter the address setting interface. This interface allows you to set and use system registers and user-defined tags. You can click the address tag library or project tree - library - address tag library below to set the tags used (see 5-2 Address Tag Library for the use of address tag library and user-defined tags)
	address	Set the monitoring address of the bar graph and set whether to offset the address (i.e. indirectly specify)
	data type	Byte-8Bit; Word-16Bit; DWord- 32Bit; DDWord -64Bit; BCD code; Hex format; Signed; Unsigned; Floating number
indirect specify	Set the current address offset. The current register address changes as the indirectly specified register value changes, that is, $D_x [D_y]=D [x+D_y \text{ value}]$ ($x, y=0, 1, 2, 3\dots$). Example: The current register address is PSW0, if the indirectly specified address is PSW100; When the value of the PSW100 register is 0, the register that controls this component remains PSW0; When the value of the PSW100 register is 1, the register that controls this component is PSW1 (and so on)	

■ Appearance

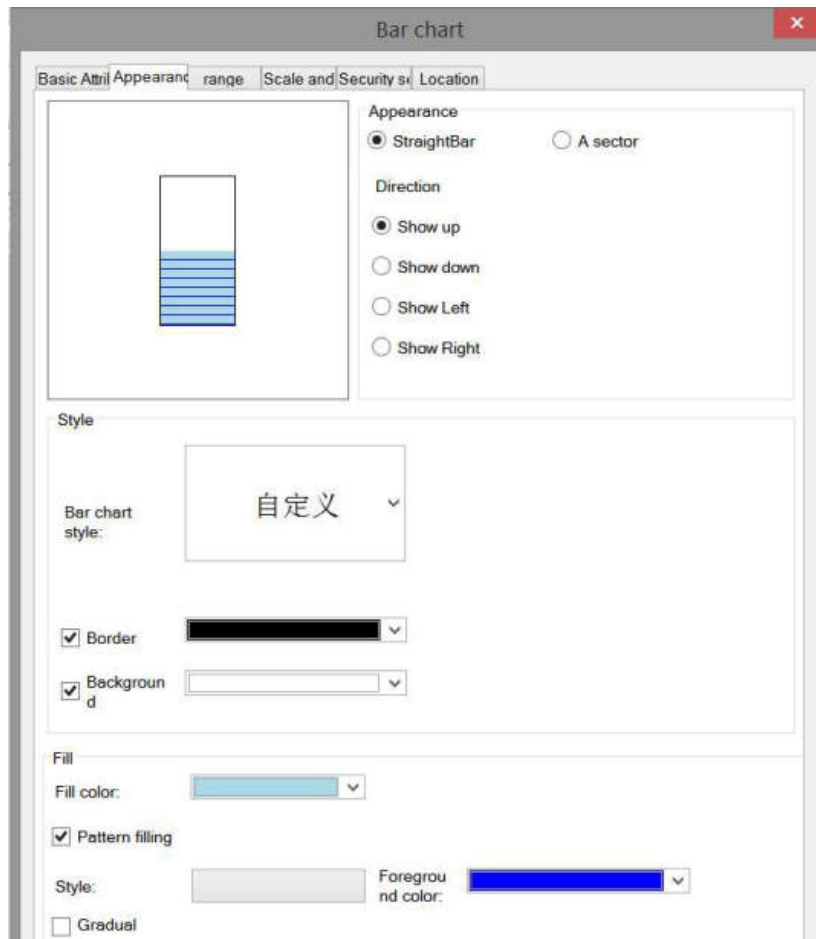

appearance	Select the appearance of the bar graph, and you can choose between straight bars or sectors	
straightbar	The style of a regular bar chart	
direction	Set the bar graph indication direction, including up, down, left, and right display	
a sector	Displayed as a fan, starting angle and coverage angle can be set	
proportion of inner and outer rings	Change the display radius of the sector by changing this value (scale range: 1-99)  proportion: 1 50 100	
direction	Set the fan indication direction, clockwise or counterclockwise	
style	bar chart style	Select the bar chart style in the drop-down box
	border	Set the border color of the bar chart
	background	Set the background color of the bar chart
fill	fill color	Choose a fill color
	pattery filling	Set a fill style, and set the foreground color
	gradual	Choose whether to gradient fill, set the gradient style, foreground color, and transparency (you can set the transparency by sliding the slider. The closer the slider is to the left, the lower the transparency value, and the more transparent the foreground color is)

Gradual

Style: From left to right Foreground color:

Transparency: 39

Using a gradient from left to right as an example to set transparency (0-255)

transparency: 0 255

■ Range



range		Set the display range of the bar graph
max		Set the max value of the bar graph, which can be specified by setting a register
min		Set the min value of the bar graph, which can be specified by setting a register
target interval	target value	Set the target value, and display the set color when the value is within the target value +/- allowable error
	error range	Used to determine the target range
	target interval color	Set target interval color
alarm range	alarm upper limit	Set the maximum alarm value of the bar graph, which can be specified by setting a register

	alarm lower limit	Set the minimum alarm value of the bar graph, which can be specified by setting a register
	color	Set the lower alarm range liquid color
exceed the upper limit	fill color	Set the color of liquids exceeding the upper limit
exceed the lower limit	fill color	Set the color of liquids exceeding the lower limit

■ Scale and mark

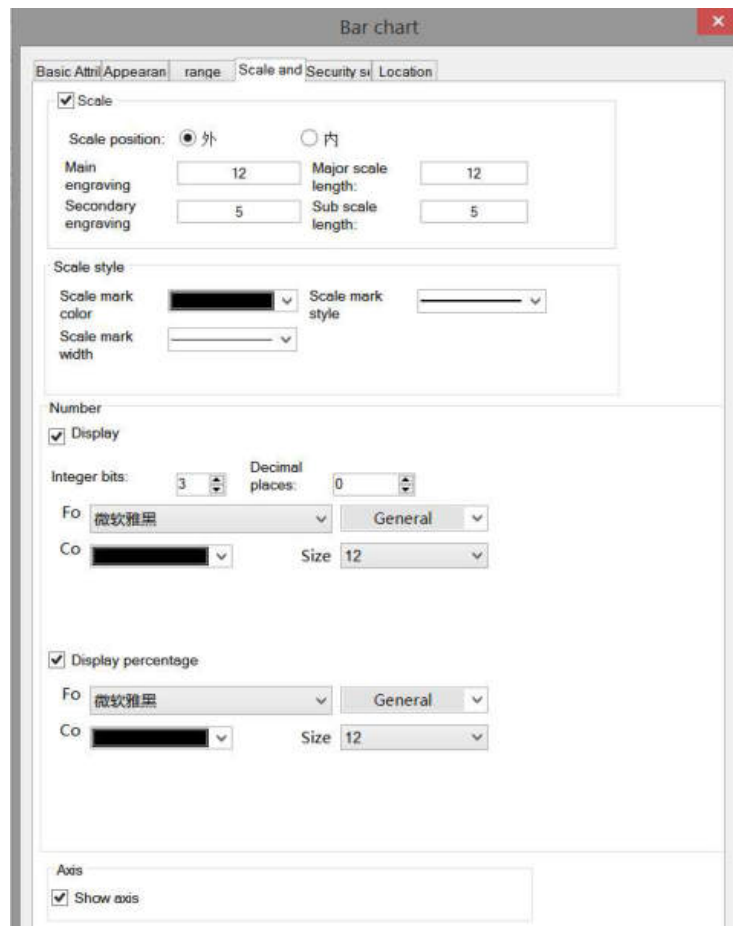

	scale	Set whether to display the scale and select a scale style
	scale position	Set the position of the scale, including inside and outside
	main engraving	Set the number of divisions for the main scale
	major scale length	set the main scale length
	secondary engraving	Set the number of divisions for the sub scale
	subscale length	set the subscale length
	scale style	Set the color, style, and width of the scale
number	display	Choose whether to display numbers on the bar graph and set the font, size, and alignment for display
	display percentage	Choose whether to display percentages on the bar graph and set the font, size, and alignment to display
axis	show axis	Set whether to display the axis line at the bottom of the scale

■ Security setting

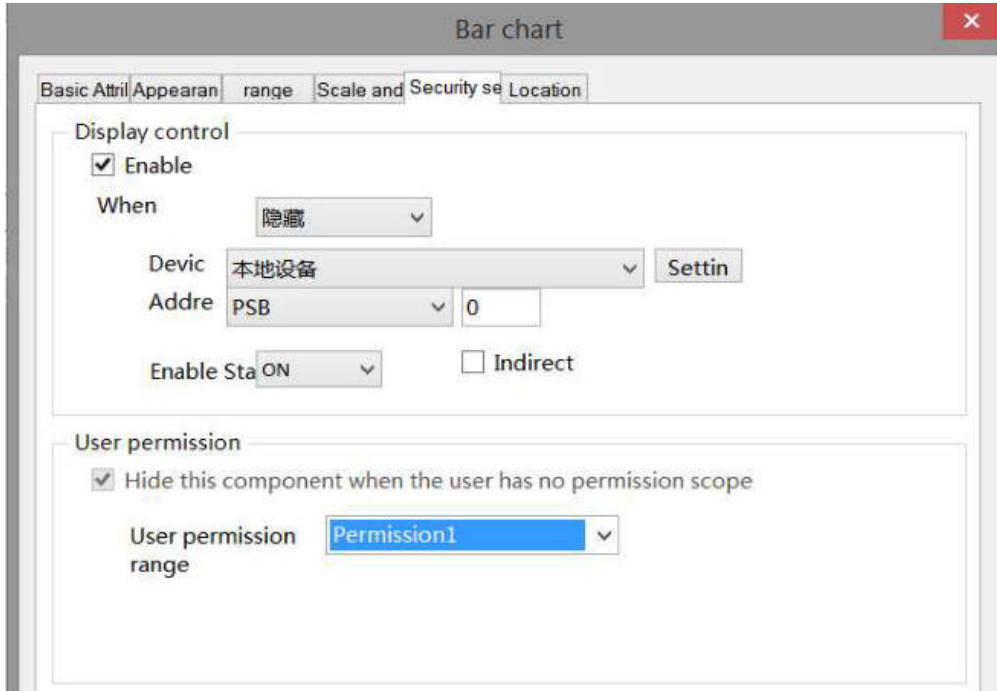

Same to chapter 4-1-1 straight line security setting part.

■ Location

Same to chapter 4-1-1 straight line location part.

4-3-7. Buzzer

When the specified coil is triggered or the specified conditions are met, the buzzer emits a sound. This component is invisible and is not visible when downloaded to the HMI.

1. Click the buzzer icon in the menu bar "Parts/Industry/Buzzer" or  in the device bar of the control window, move the cursor to the screen, click the left mouse button to place, click the right mouse button, or click ESC to cancel the placement.
2. When setting attributes, you can set them in the attribute box that pops up when placing components. You can also double-click "Buzzer" or select "Buzzer" and right-click to select "attributes" to set attributes.

■ Basic attributes

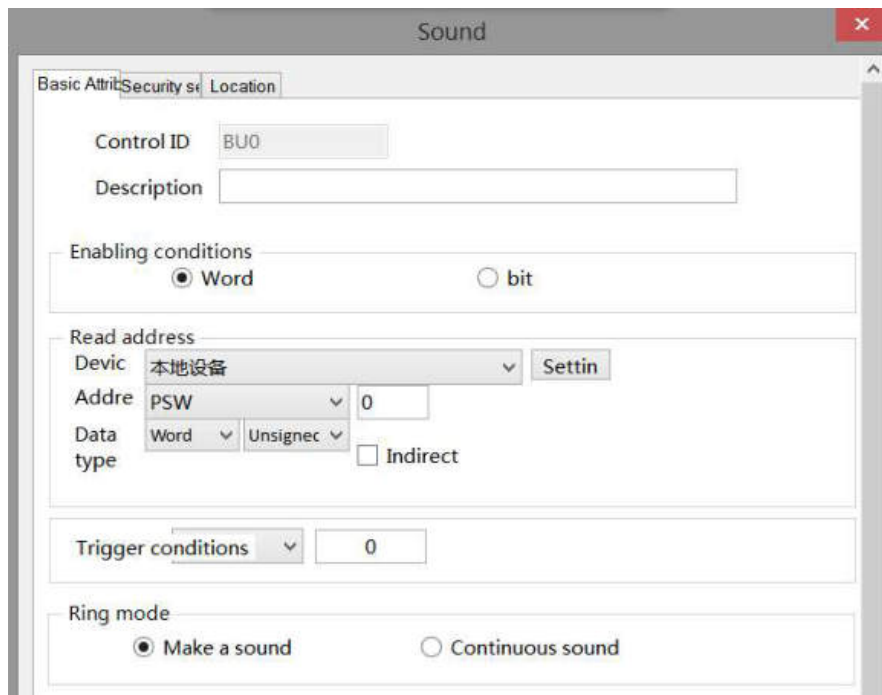

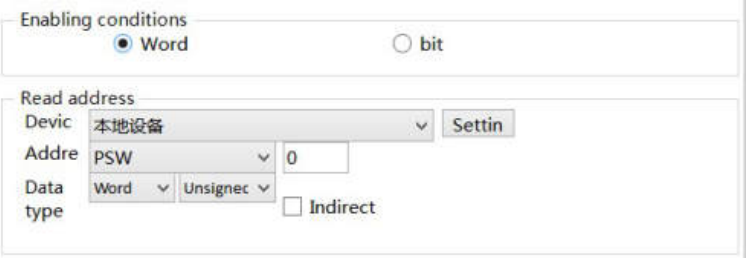
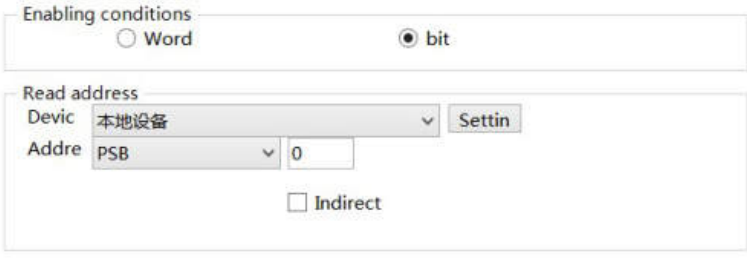
control ID	It is used for system management control, and cannot be operated by users
description	Can be used to comment on the purpose of this control
enabling conditions	Set the enabling condition to "word" or "bit"
read address	enabling condition is word 
	enabling condition is bit 
	device setting Select the device port currently communicating with Click "Settings" to enter the address setting interface. This interface allows you to set and use system registers and user-defined tags. You can click the address tag library or project tree - library - address tag library below to set the tags used (see 5-2 Address Tag Library for the use of address tag library and user-defined tags)

	address	Set the object address of the buzzer and whether it is offset (i.e. indirectly specified)
	data type	Byte-8Bit; Word-16Bit; DWord- 32Bit; DDWord -64Bit; BCD code; Hex; Signed; Unsigned; Floating number
	indirect specify	Set the current address offset. The current register address changes as the indirectly specified register value changes, that is, $Dx [Dy]=D [x+Dy \text{ value}]$ ($x, y=0, 1, 2, 3\dots$). Example: The current register address is PSW0, if the indirectly specified address is PSW100; When the value of the PSW100 register is 0, the register that controls this component remains PSW0; When the value of the PSW100 register is 1, the register that controls this component is PSW1 (and so on)
	trigger condition	If the enabling condition is "Word", the setting that meets the conditions ">,<=,!=,>=,<=a certain value" is valid; If the enabling condition is "bit", setting "OFF" or "ON" is valid
ring mode	make a sound	When the conditions are met, only one sound is made
	continuous sound	Keep ringing when conditions are met

■ Security setting

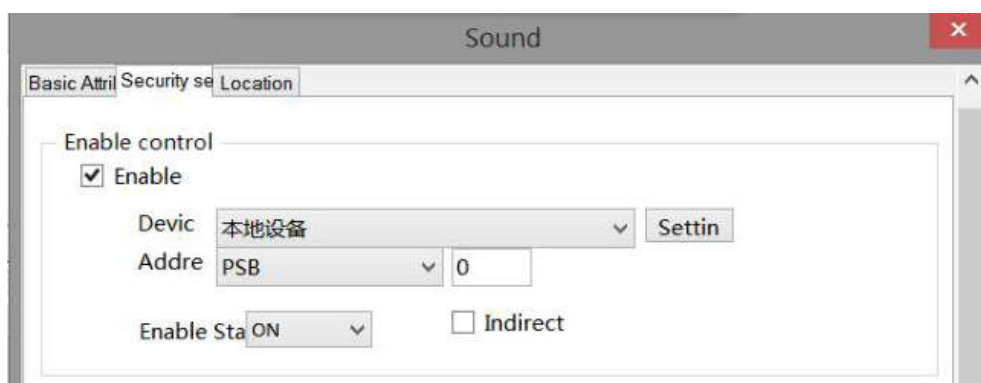

enable	The bit limit can be set (the enabling state of the enabling control can be customized). Only when the enabling conditions are met can the component be used normally (as shown in the figure above: When PSB0 is in the ON state and the trigger conditions are met, the component can be used; if PSB0 is in the OFF state, even if the trigger condition is met, the component is still unavailable)
--------	---

■ Location

same to chapter 4-1-1 straight line location part. (It is not allowed to modify the size and move horizontally and vertically)

4-3-8. Backlight

This control is used to determine whether to display the backlight. When the backlight control coil is triggered, the screen backlight is turned on, which means exiting the screen saver black screen. If the screen saver is not entered or set to display the screen, this function is invalid. This component is invisible and is not visible when downloaded to the HMI.

1. Click the backlight icon in the menu bar "Parts/Industry/Backlight" or  in the control window's device bar, move the cursor to the screen, click the left mouse button, click the right mouse button, or use the ESC key to cancel placement.
2. When setting attributes, you can set them in the attribute box that pops up when placing components. You can also double-click "Backlight" or select "Backlight" and right-click to select "attributes" to set attributes.

■ Basic attributes

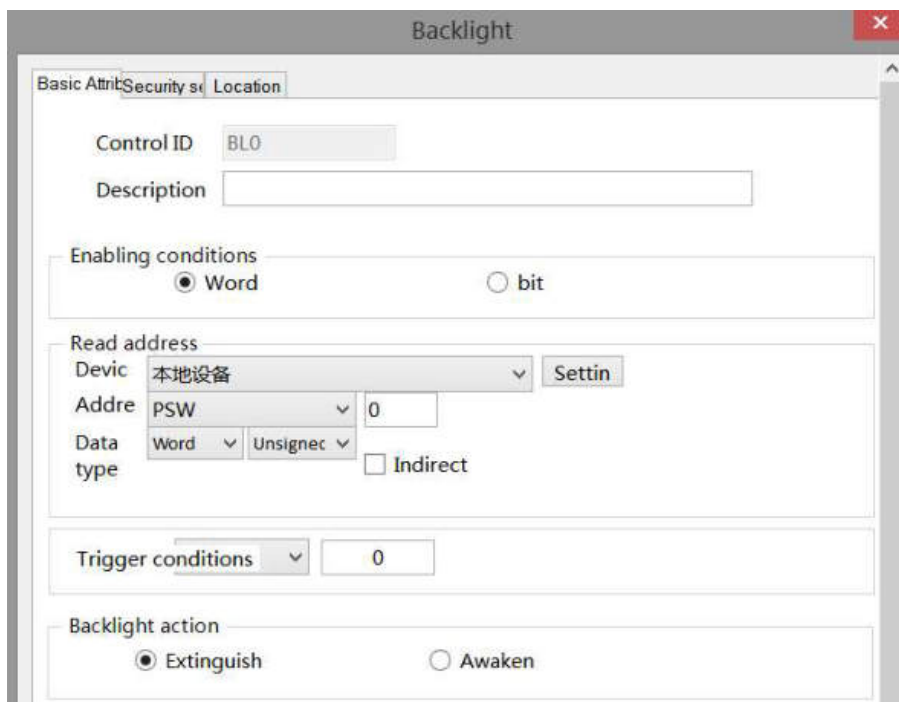

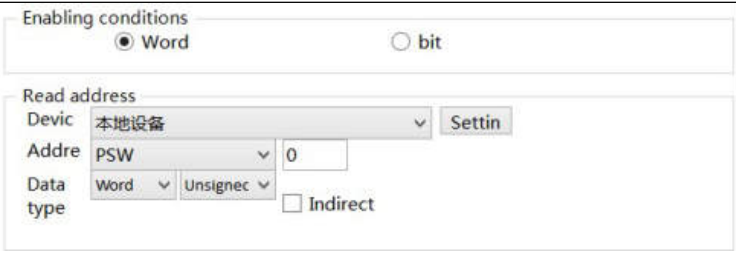
control ID	It is used for system management control, and cannot be operated by users
description	Can be used to comment on the purpose of this control
enabling conditions	Set the enabling condition to "word" or "bit"
enabling condition is word	

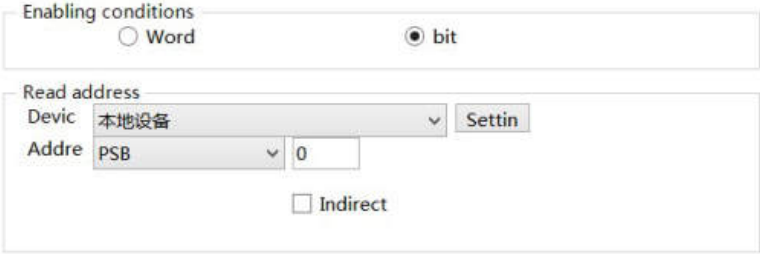
enabling condition is bit		
read address	device	Select the device port currently communicating with
	setting	Click "Settings" to enter the address setting interface. This interface allows you to set and use system registers and user-defined tags. You can click the address tag library or project tree - library - address tag library below to set the tags used (see 5-2 Address Tag Library for the use of address tag library and user-defined tags)
	address	Set the object address of the control backlight and whether it is offset (i.e. indirectly specified)
	data type	Byte-8Bit; Word-16Bit; DWord- 32Bit; DDWord -64Bit; BCD code; Hex format; Signed; Unsigned; Floating number
	indirect specify	Set the current address offset. The current register address changes as the indirectly specified register value changes, that is, $Dx [Dy]=D [x+Dy \text{ value}]$ ($x, y=0, 1, 2, 3\dots$). Example: The current register address is PSW0, if the indirectly specified address is PSW100; When the value of the PSW100 register is 0, the register that controls this component remains PSW0; When the value of the PSW100 register is 1, the register that controls this component is PSW1 (and so on)
trigger condition		If the enabling condition is "Word", the setting that meets the conditions ">,<,<=,>=,<=a certain value" is valid; If the enabling condition is "bit", setting "OFF" or "ON" is valid
backlight action		Set the backlight actions, including turning off and waking up

■ Security setting

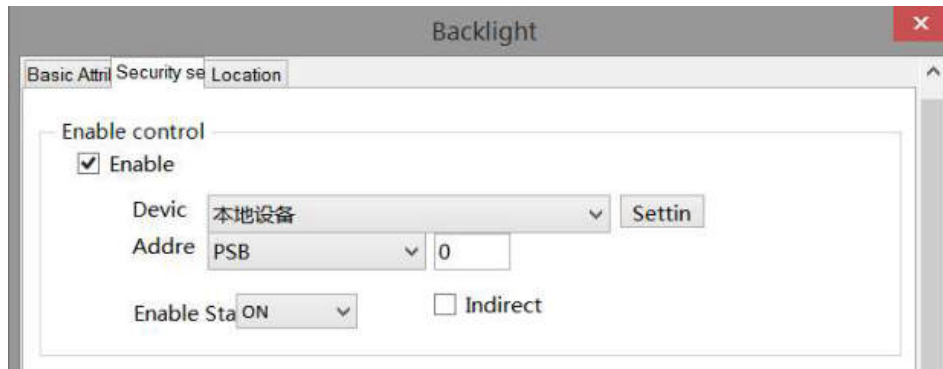

enable control	The bit limit can be set (the enabling state of the enabling control can be customized). Only when the enabling conditions are met can the component be used normally (as shown in the figure above: When PSB0 is in the ON state and the trigger conditions are met, the component can be used; if PSB0 is in the OFF state, even if the trigger condition is met, the component is still unavailable)
----------------	---

■ Location

Same to chapter 4-1-1 straight line location part (It is not allowed to modify the size and move horizontally and vertically)

4-3-9. Fan

1. Click the fan icon in the menu bar "Parts/Industry/Fan" or  in the device bar of the control window, move the cursor to the screen, click the left mouse button to place, click the right mouse button, or click ESC to cancel the placement. Modify the length and width of the border through boundary points.
2. When setting attributes, you can set them in the attribute box that pops up when placing components, or you can double-click "Fan" or select "Fan" and right-click to select "attribute" for attribute settings.



■ Basic attributes

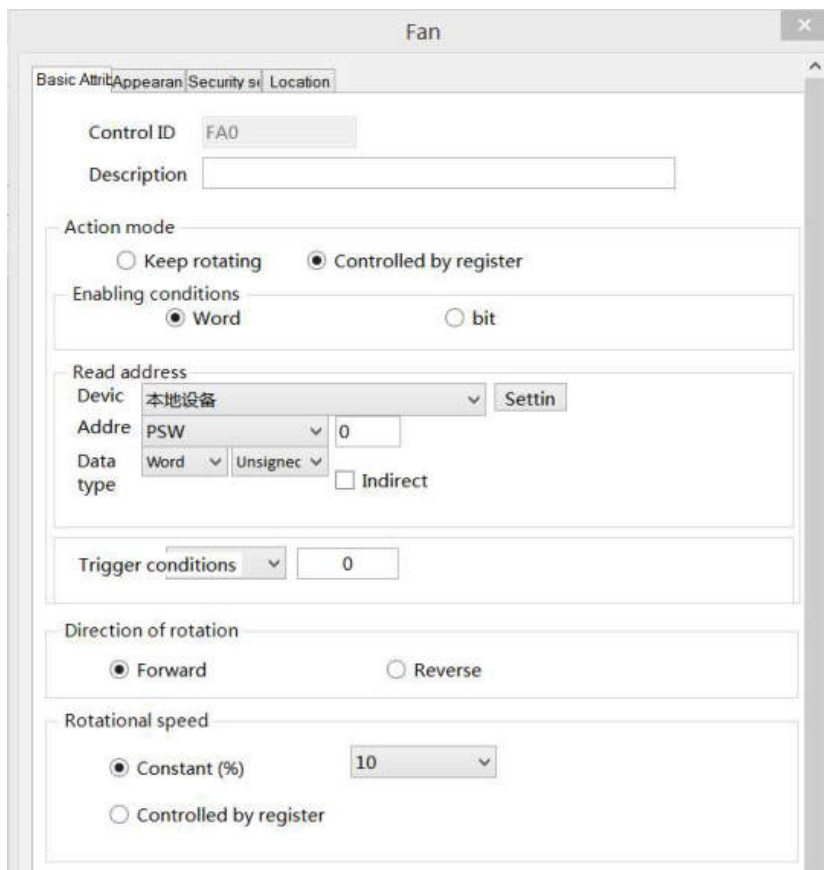

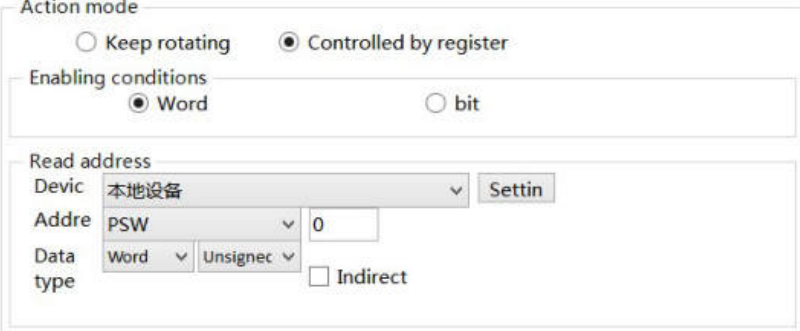
control ID	It is used for system management control, and cannot be operated by users
description	Can be used to comment on the purpose of this control
action mode	Set the action mode of the fan, including keep rotating and controlled by register
keep rotating	Set the action mode of the fan to always rotate
controlled by register	Set the action mode of the fan to be controlled by the register 
enabling condition	Set the enabling condition of the fan to word or bit
read address	Set the coil address of the control fan and set whether there is an offset (i.e., indirectly specified)
device	Select the device port currently communicating with
setting	Click "Settings" to enter the address setting interface. This interface allows you to set and use system registers and user-defined tags. You can click the address tag library or project tree - library - address tag library below to set the tags used (see 5-2 Address Tag Library for the use of address tag library and user-defined tags)

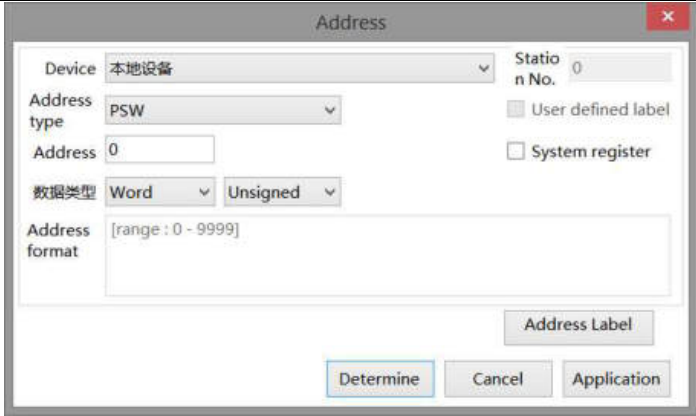
	
address	Set the monitoring address of the fan and set whether to offset the address (i.e. indirectly specify)
data type	Byte-8Bit; Word-16Bit; DWord- 32Bit; DDWord -64Bit; BCD code; Hex format; Signed; Unsigned; Floating number
indirect specify	Set the current address offset. The current register address changes as the indirectly specified register value changes, that is, $D_x [D_y]=D [x+D_y \text{ value}]$ ($x, y=0, 1, 2, 3\dots$). Example: The current register address is PSW0, if the indirectly specified address is PSW100; When the value of the PSW100 register is 0, the register that controls this component remains PSW0; When the value of the PSW100 register is 1, the register that controls this component is PSW1 (and so on)
trigger condition	If "Controlled by Register" is selected If the enabling condition is "word", the setting meets certain conditions $>, <, <=, >=, ==, !=$ a certain value is valid; If the enabling condition is "bit", setting "OFF" or "ON" is valid;
rotation direction	Set the rotation direction of the fan, including forward (clockwise) and reverse (counterclockwise) directions
rotation speed	Set the rotational speed of the fan, which can be set as a constant, or set a register to control the speed (when the speed set in the register is 10, flow at the lowest speed of 10, when set to 100, flow at the highest speed of 100)

■ Appearance

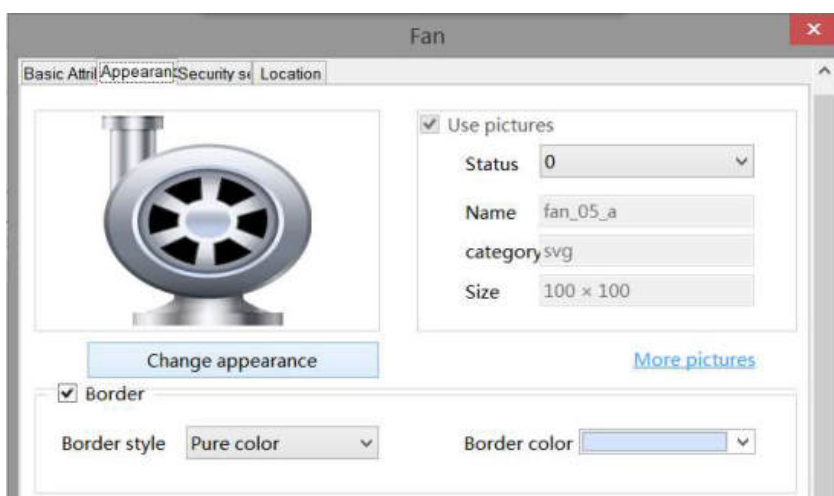

change appearance	Set display appearance
use pictures	Set whether to use pictures. You can set the appearance of clicking in three states (0, 1, 2). After selecting the state in the upper right corner, click "Change Appearance" or click "More Pictures" to select custom

	images to change the appearance
fill	Set the fill style (solid/gradient) and fill color
border	Set border style (solid/gradient) and border color

■ Security setting

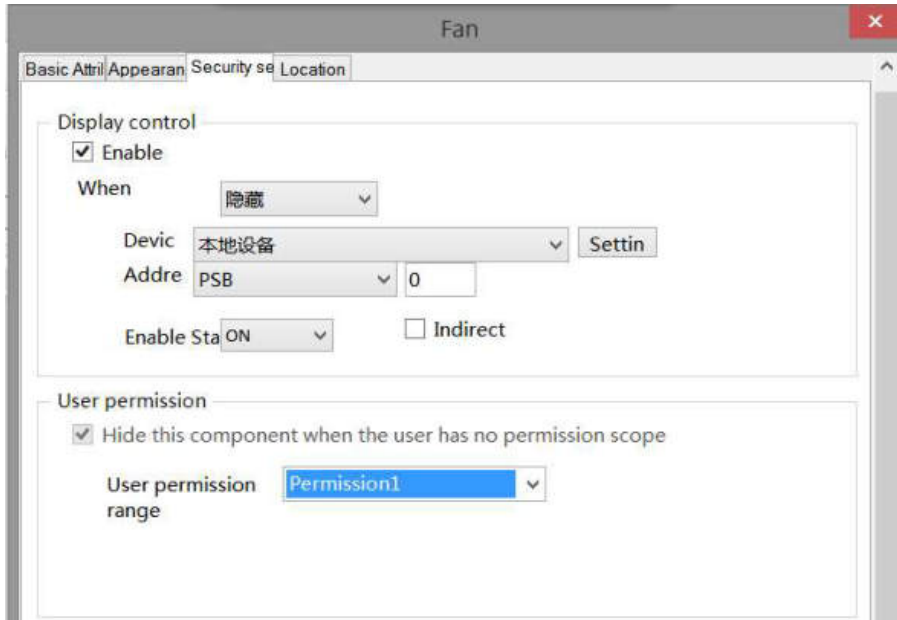

same to chapter 4-1-1 straight line security setting part.

■ Location

Same to chapter 4-1-1 straight line location part.

4-3-10. Agitator

1. Click the agitator icon in the menu bar "Parts/Industrial/Agitator" or  in the control window's device bar, move the cursor to the screen, click the left mouse button to place, click the right mouse button, or press ESC to cancel placement. Modify the length and width of the border through boundary points.
2. When setting attributes, you can set them in the attribute box that pops up when placing components. You can also double-click "agitator" or select "agitator" and right-click to select "attributes" to set attributes.



■ Basic attributes

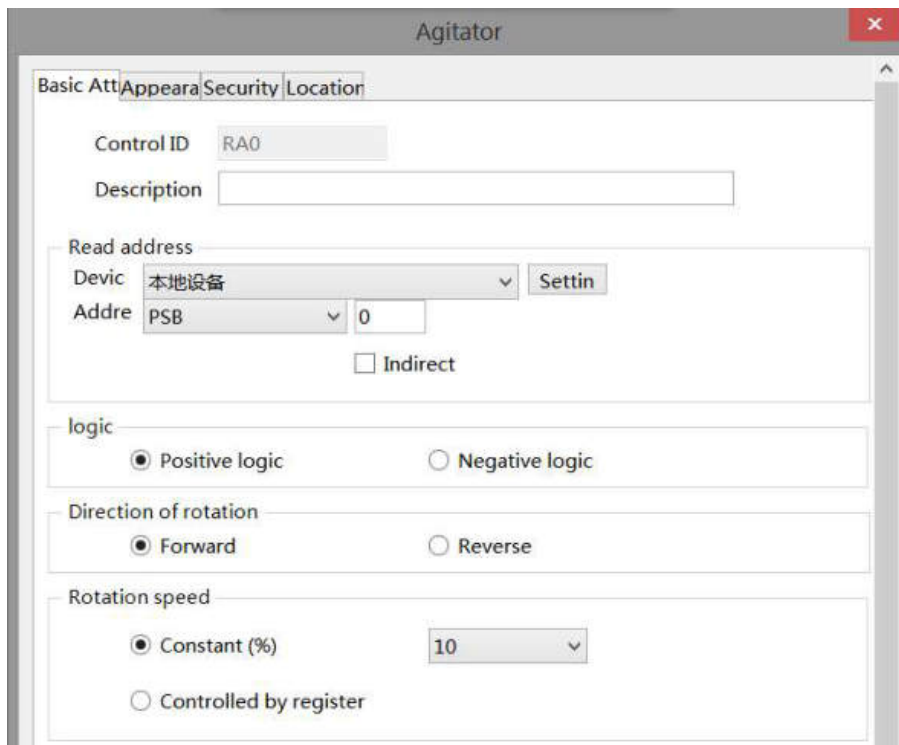

control ID	It is used for system management control, and cannot be operated by users	
description	Can be used to comment on the purpose of this control	
read address	device	Select the device port currently communicating with
	setting	Click "Settings" to enter the address setting interface. This interface allows you to set and use system registers and user-defined tags. You can click the address tag library or the project tree - library - address tag library below to set the tags used (see 5-2 Address Tag Library for the use of address tag library and user-defined tags)
address	Set the coil address that controls the action of the agitator, and set whether there is an offset (i.e. indirectly specified)	
indirect specify	Set the current address offset. The current register address changes as the indirectly specified register value changes, that is, $Dx [Dy]=D [x+Dy \text{ value}]$ ($x, y=0, 1, 2, 3\dots$). Example: The current register address is PSW0, if the indirectly specified address is PSW100; When the value of the PSW100 register is 0, the register that controls this component remains PSW0; When the value of the PSW100 register is 1, the register that controls this component is PSW1 (and so on)	

logic	Select the agitator action state as positive logic or negative logic; Positive logic: Start action when the set coil is in the ON state; Negative logic: Start action when the set coil is in the OFF state
direction of rotation	Set the rotation direction of the mixer, including forward (clockwise) and reverse (counterclockwise) directions
rotation speed	Set the rotation speed of the agitator, which can be set as a constant, or set a register to control the speed (when the speed set in the register is 10, flow at the lowest speed of 10, when set to 100, flow at the highest speed of 100)

■ Appearance



change appearance	set the display appearance
use pictures	Set whether to use pictures You can set the appearance of clicking in three states (0, 1, 2). After selecting the state in the upper right corner, click "Change Appearance" or click "More Pictures" to select custom images to change the appearance;
border	Set border style and color

■ Security setting

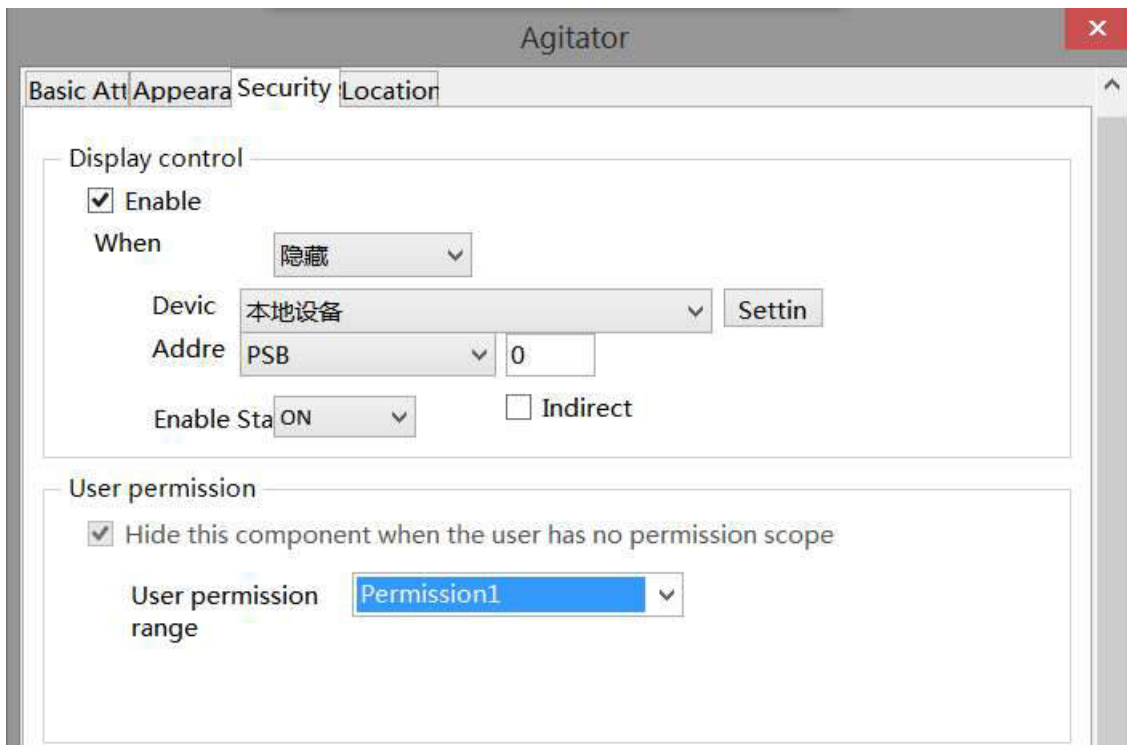

same to chapter 4-1-1 straight line security setting part.

■ Location

Same to chapter 4-1-1 straight line location part.

4-3-11. Water pump

This control is used to simulate the operation process of the on-site water pump. When the target coil reaches the specified state, the water pump starts to operate.

1. Click the water pump icon in the menu bar "Parts/Industry/Water Pump" or  in the control window's equipment bar, move the cursor to the screen, click the left mouse button to place, click the right mouse button, or click ESC to cancel placement. Modify the length and width of the border through boundary points.
2. When setting attributes, you can set them in the attribute box that pops up when placing components, or you can double-click "Water Pump" or select "Water Pump" and right-click to select "attributes" for attribute settings.



■ Basic attributes

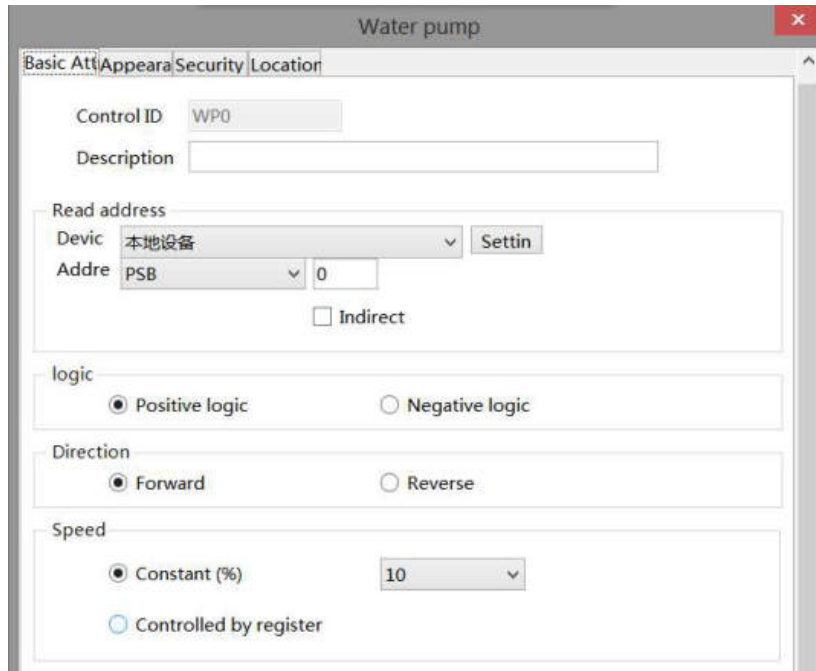

control ID	It is used for system management control, and cannot be operated by users	
description	Can be used to comment on the purpose of this control	
read address	device	Select the device port currently communicating with
	setting	Click "Settings" to enter the address setting interface. This interface allows you to set and use system registers and user-defined tags. You can click the address tag library or the project tree - library - address tag library below to set the tags used (see 5-2 Address Tag Library for the use of address tag library and user-defined tags)
	address	Set the controlled address of the water pump, and set whether there is an offset (i.e. indirectly specified)
indirect specify	Set the current address offset. The current register address changes as the indirectly specified register value changes, that is, $Dx [Dy]=D [x+Dy \text{ value}]$ ($x, y=0, 1, 2, 3\dots$). Example: The current register address is PSW0, if the indirectly specified address is PSW100; When the value of the PSW100 register is 0, the register that controls this component remains PSW0; When the value of the PSW100 register is 1, the register that controls this component is PSW1 (and so on)	
logic	Select the pump action state to be positive logic or negative logic	

	Positive logic: Start action when the set coil is in the ON state; Negative logic: Start action when the set coil is in the OFF state
direction	Set the rotation direction of the water pump, including forward direction (water flow from left to right) and reverse direction (water flow from right to left)
speed	Set the flow speed of water flow, which can be set as a constant, or set a register to control the speed (when the speed set in the register is 10, flow at the lowest speed of 10, when set to 100, flow at the highest speed of 100)

■ Appearance

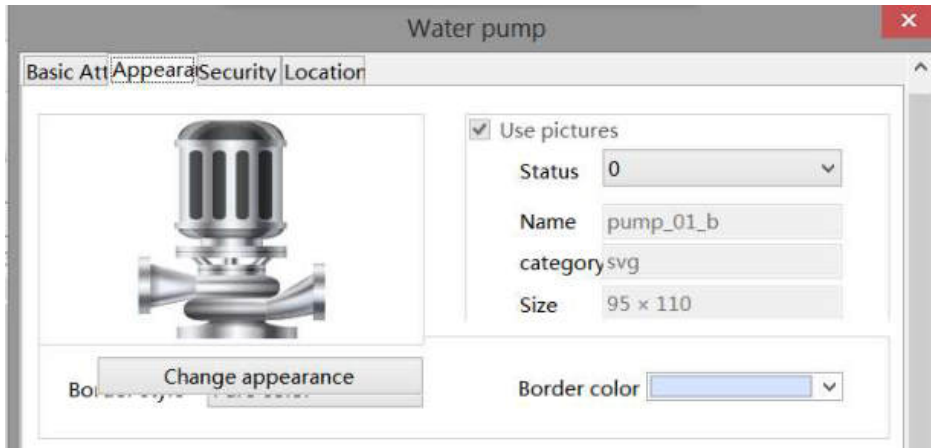

change appearance	Set display appearance
use pictures	Set whether to use pictures; You can set the appearance of clicking in two states: (0, 1). After selecting the state in the upper right corner, click "Change Appearance" or click "More Pictures" to select custom images to change the appearance
border	Set border style and color

■ Security setting

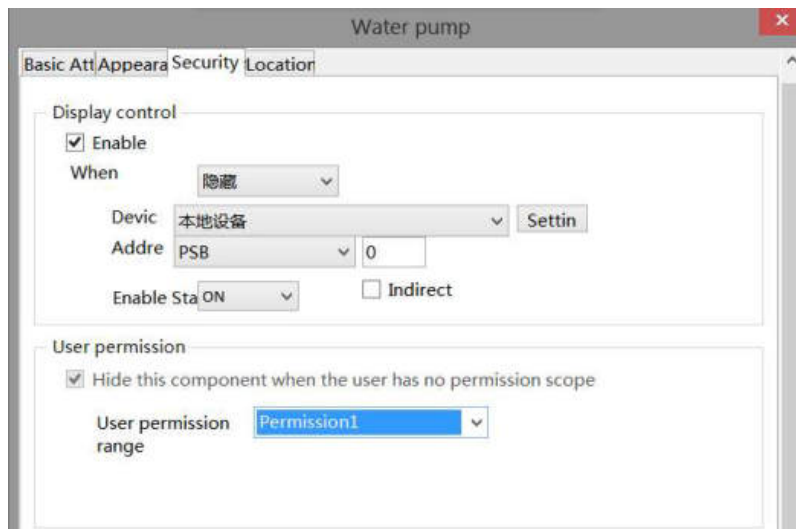

same to chapter 4-1-1 straight line security setting part.

■ Location

Same to chapter 4-1-1 straight line location part.

4-3-12. Valve

This control is used to simulate the operation of valves in the field control system. The following valve states are in the closed and open flow states, respectively.

1. Click the icon in the menu bar "Parts/Industry/Valves" or  in the control window's device bar, move the cursor to the screen, click the left mouse button to place, click the right mouse button, or click ESC to cancel the placement. Modify the length and width of the border through boundary points.
2. When setting attributes, you can set them in the attribute box that pops up when placing components, or you can double-click "Valve" or select "Valve" and right-click to select "attributes" for attribute settings.



■ Basic attributes

Valve

Basic Att
Appear
Security
Location

Control ID

Description

Read / Write use different address

Read address

Devic 本地设备

Addre PSB

Indirect

Write address

Devic 本地设备

Addre PSB

Indirect

Action

Conduction

Close

On / off

On when pressec

logic

Positive logic

Negative logic

Direction

Forward

Reverse

Speed

Constant (%)

Controlled by register

control ID	It is used for system management control, and cannot be operated by users
description	Can be used to comment on the purpose of this control
read/write use	You can check whether to use a different address for reading/writing (refer to 4-2-3)

different address	Numerical Input for the description of the reading/writing address)
read address	Set the read address of the valve and set whether there is an offset (i.e. indirectly specified)
write address	Set the write address of the valve and set whether there is an offset (i.e. indirectly specified)
indirect specify	Set the current address offset. The current register address changes as the indirectly specified register value changes, that is, $Dx [Dy]=D [x+Dy \text{ value}]$ ($x, y=0, 1, 2, 3\dots$). Example: The current register address is PSW0, if the indirectly specified address is PSW100; When the value of the PSW100 register is 0, the register that controls this component remains PSW0; When the value of the PSW100 register is 1, the register that controls this component is PSW1 (and so on)
action	Select the control action of the valve
ON	After triggering, the valve is always open
OFF	After triggering, the valve is always close
ON/OFF	When triggered for the first time, the valve is in the open state, and when triggered again, it is in the closed state, which is reversed
ON when pressed	When pressed, the valve is in an open state; When released, the valve is closed
logic	Select whether the valve action state is positive logic or negative logic; Positive logic: Start action when the set coil is in the ON state; Negative logic: Start action when the set coil is in the OFF state
direction	Set the flow direction of water flow, including forward direction (water flow from left to right) and reverse direction (water flow from right to left)
speed	Set the flow speed of water flow, which can be set as a constant, or set a register to control the speed (when the speed set in the register is 10, flow at the lowest speed of 10, when set to 100, flow at the highest speed of 100)

■ Appearance

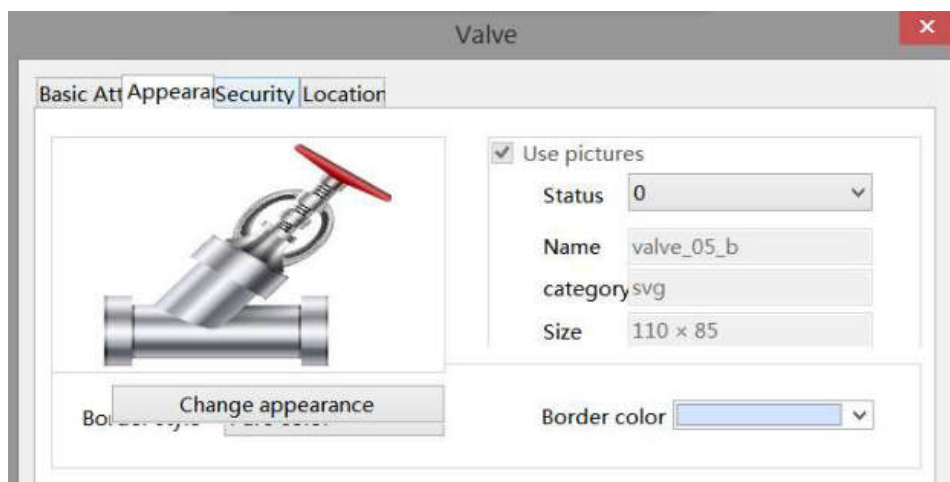

change appearance	Set display appearance
use pictures	Set whether to use pictures
status	There are two optional states, 0 and 1, to set the state of the control
name	Display the name of this control
category	Display the category of this control
size	Displays the current size of the control
border	Set border style and color

■ Security setting

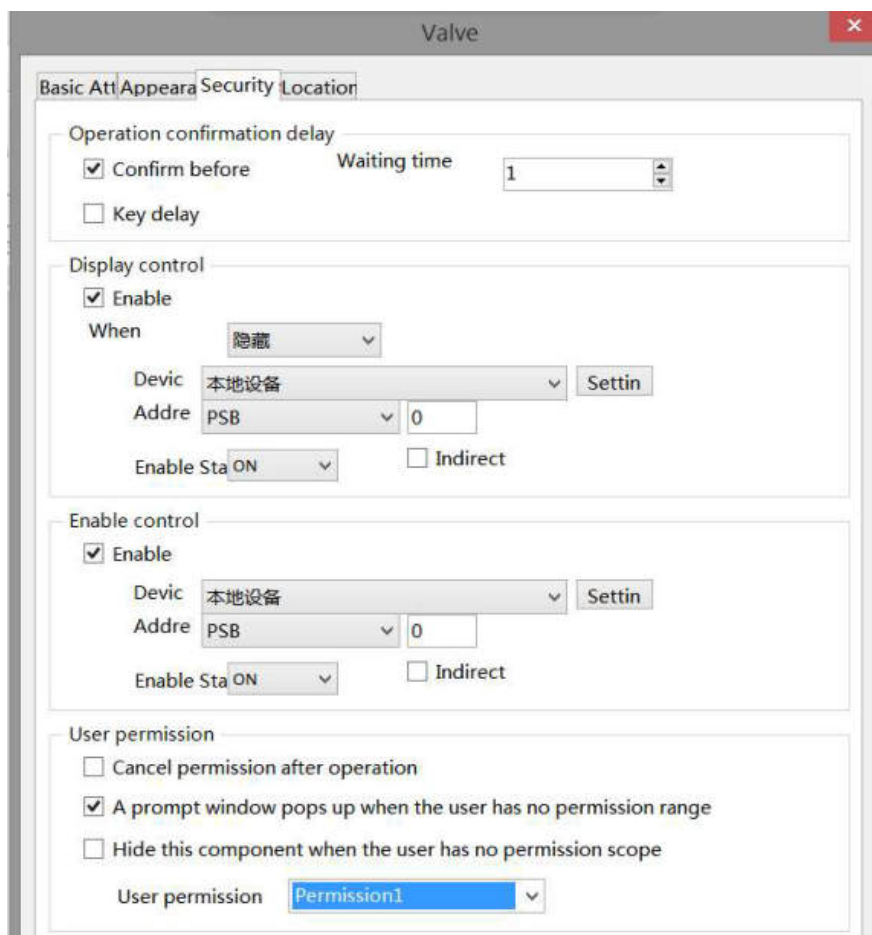

Same to chapter 4-2-10 indicator key security setting part.

■ Location

Same to chapter 4-1-1 straight line location part.

4-4. Alarm

4-4-1. Alarm entry

Click "Parts/Alarm/Alarm Entry" in the menu bar or click  to add alarm objects and corresponding alarm information to the pop-up window, which can be imported/exported to the computer for alarm display.

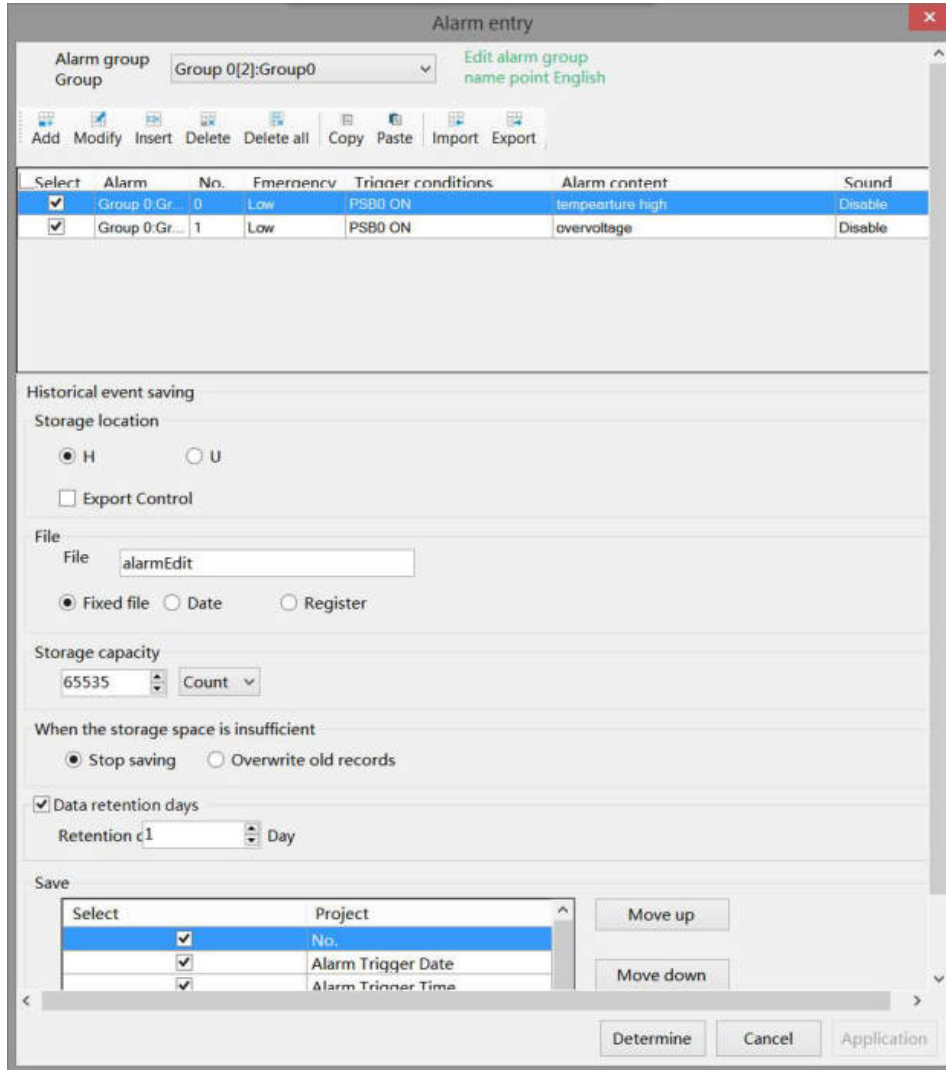

■ Alarm group

alarm group	Set the group of the alarm group, and select the corresponding group display in the alarm display
edit alarm group name	Click to set the name of each alarm group

■ Information

add	add alarm information
modify	Modify the selected alarm information, and the modify information interface is consistent with the add information interface
insert	Insert an alarm message below the selected alarm message
delete	Delete the selected alarm information
delete all	Delete all alarm information

copy	Tick the alarm information to be copied in the front box
paste	Paste the copied information, and the pasted alarm information will be displayed on the last line
import	Import an edited Excel file from your computer
export	Export the alarm information edited in the software as an Excel file to the designated location in the computer

Before clicking Add, you must first select an alarm group in the group, otherwise a prompt to select an alarm group will pop up, as shown in the following figure:

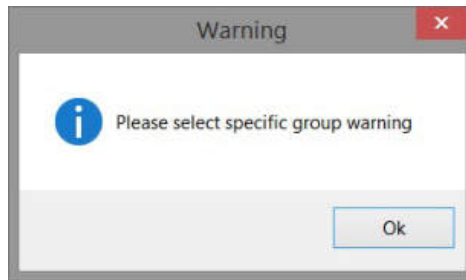

After clicking Add, you can add alarm signals and corresponding alarm information in the pop-up window, as shown in the following figure:

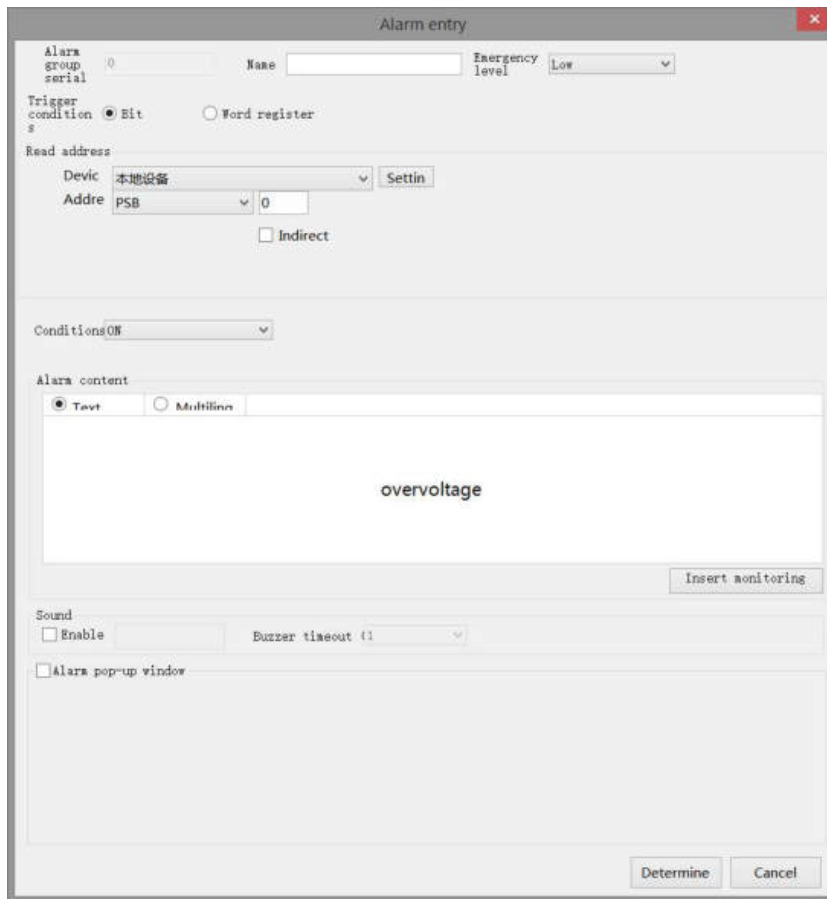

Alarm Group Serial Number	Display the current alarm group and cannot be modified
name	Custom alarm name
emergency level	Set the alarm urgency level of the current alarm information. You can select "Low, Normal, High, and Urgent" to increase the urgency level in turn
read address	Set the displayed address; You can also set whether there is an offset (i.e. indirectly)

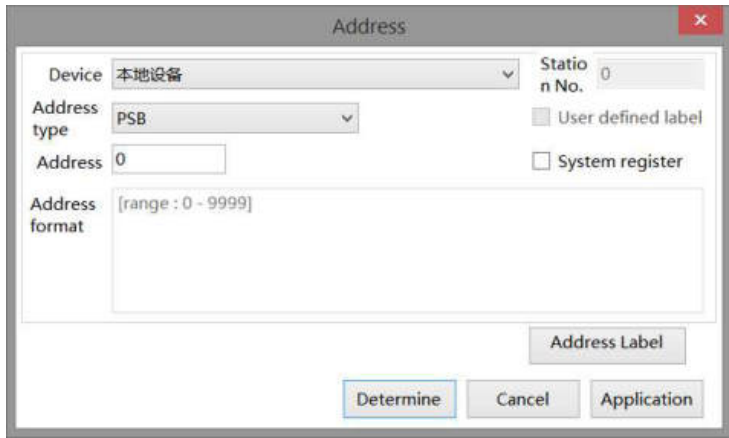
	specified)
device	Device port currently communicating
address	Set target coil number
setting	<p>Click "Settings" to enter the address setting interface. This interface allows you to set and use system registers and user-defined tags. You can click the address tag library or the project tree - library - address tag library below to set the tags used (see 5-2 Address Tag Library for the use of address tag library and user-defined tags)</p> 
indirect specify	Set the current address offset. The current coil address changes with the indirectly specified register value, that is, $Dx [Dy]=D [x+Dy \text{ value}]$ ($x, y=0, 1, 2, 3\dots$). Example: The current coil address is PSB0, if the indirectly specified address is PSW100; When the value of the PSW100 register is 0, the coil that controls this element remains PSB0; When the value of the PSW100 register is 1, the coil that controls this element is PSB1 (and so on)
condition	Set the trigger conditions for alarm information, and you can select bit registers and word registers; When selecting a bit register, you can choose to set the trigger conditions to ON, OFF, ON ->OFF, and OFF ->ON, which can be selected according to project needs. When selecting a word register, you can choose to trigger when $>$, $<$, $=$, \neq , \geq , \leq a certain value
alarm content	Edit the text information or multilingual display of the alarm (refer to 5-1 for the description of the multilingual library for specific use). You can select to insert the register address display. After clicking "Insert Monitoring", edit the required information in the pop-up window and select it. The information of the set monitoring address will be displayed in the alarm content.

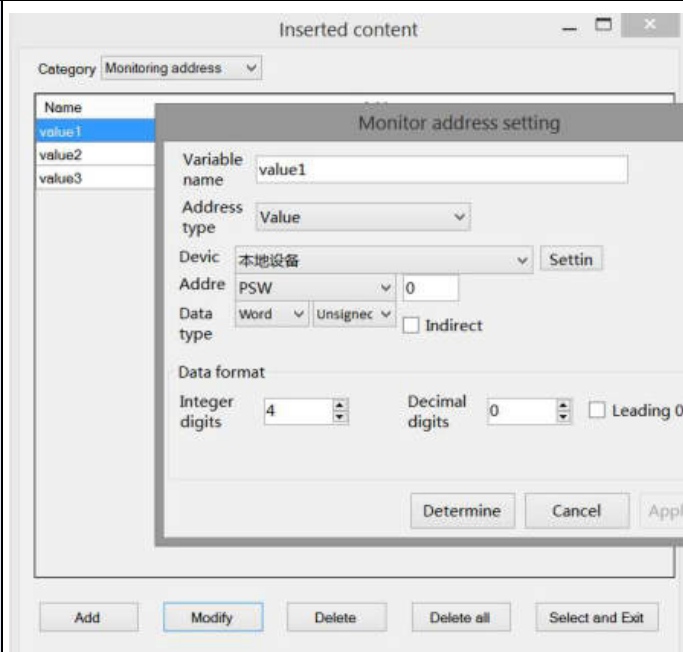

Add: Add the information to be monitored, which can monitor values, characters, and Chinese.

Modify: After selecting the line to be modified, the line turns blue. Click modify to modify the set information.

Delete: delete the selected row.

Delete All: delete all content.

Select and Exit: Select the monitoring content to be displayed, and click "Select and Exit". The software will automatically generate a {variable name} after the alarm content. When the alarm information is displayed, {} will not be displayed, but the content of the corresponding register set will be displayed.



sound	sound enable	When checked, the buzzer will sound when the alarm is triggered. If the selected touch screen model is TS5L series, the alarm sound can be customized. Refer to 5-4 Audio Resource Library for usage methods
	buzzer timeout	Set the time for the buzzer to sound, in seconds, selectable from 1 to 30 seconds
alarm pop-up window		When checked, the selected window will be displayed on the touch screen when the alarm is triggered

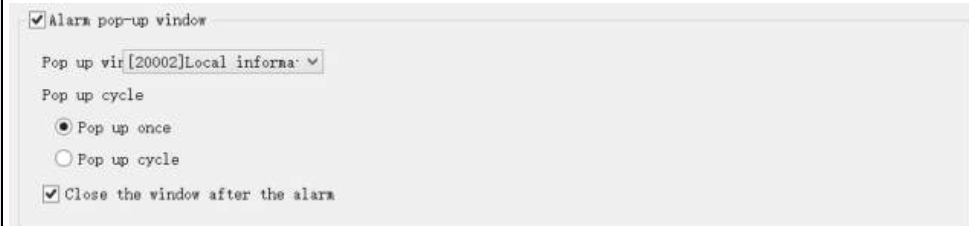

pop up window	Select the window to pop up, and it will pop up on the touch screen after the alarm is triggered
pop up cycle	<p>Popup once: only pop up once. After clicking Close, the window will not pop up again even if the alarm does not disappear</p> <p>Popup Cycle: After the alarm is triggered, the window will pop up. When the window is closed and the alarm signal does not end, it will pop up again at the set cycle. The default cycle is 1000 milliseconds, that is, 1 second (the pop up cycle unit can be customized in milliseconds/seconds/minutes)</p>
close the window after the alarm	After checking, if the window has not been manually closed since it pops up, it will actively close the window when the alarm signal disappears

■ Historical event saving

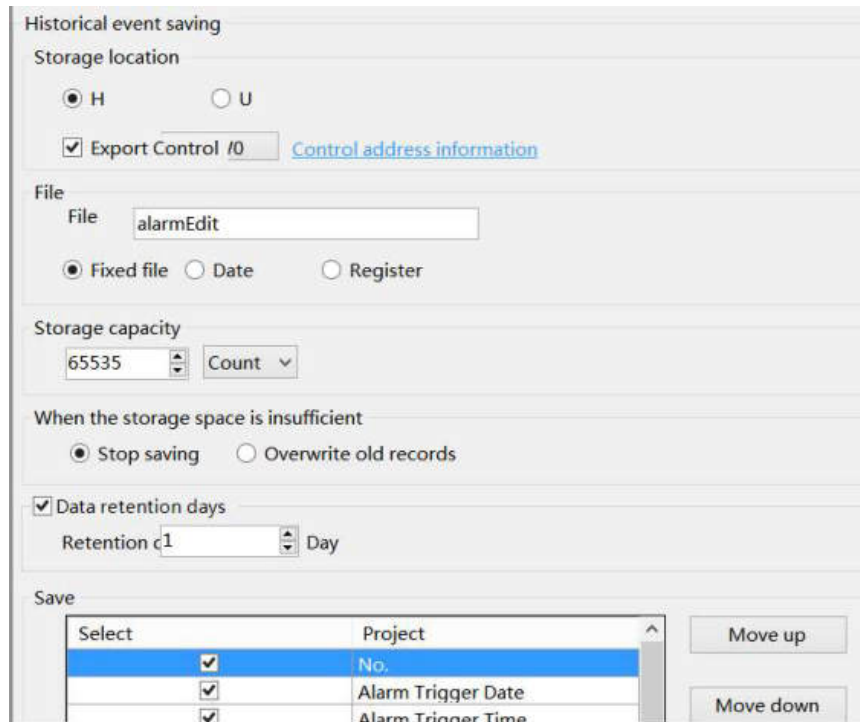

Set whether to store the selected alarm information in the touch screen. When checked, the generated alarm information will be stored in the touch screen. You can use the alarm list to display historical alarm information.

storage location	<p>To set the storage location, you can select HMI or USB flash disk, or use a register to specify the storage location. For example, if you set the register PSW0, then when PSW0=1, the storage location is HMI; When PSW=3, the storage location is a USB flash drive</p> <p> When simulating, the storage location of alarm information is:</p> <p>(1) Save to USB flash drive: software directory Temp/Run/storage/udisk/alarm</p> <p>(2) If you choose to save to the hmi: software directory Temp/Run/db/alarm, saving files in this way cannot be directly opened for viewing. To view, you need to export to a USB flash drive through the export control register, and then view the exported files in the path saved to the USB flash drive</p>
HMI export	Set the export control register (if set to PSW0, three consecutive addresses with PSW0 as the first address control different states), and click "Control Address Information" to

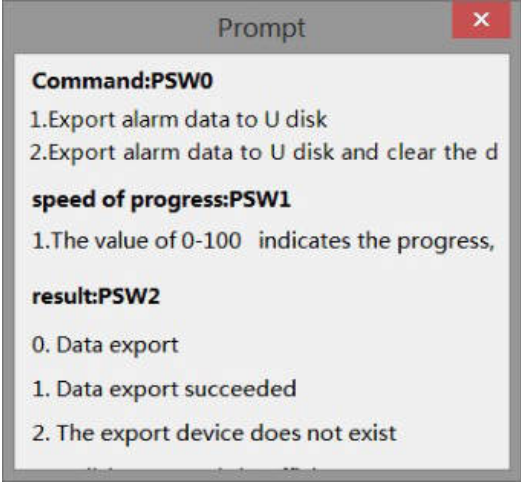
	<p>preview</p>  <p>Note: This function takes effect only when the storage location is selected as HMI or specified as HMI by using "Register Specified Storage Location".</p> <p>"When inputting 1 or 2 to the command register, the database can be controlled to be exported to a USB flash drive, and the exported file format is xjdb. The xjdb to csv tool can be opened by double clicking on the software root directory Tool\XJDbTool\XJDbTool.exe, which is set as the default opening method for xjdb. After opening, enter the path name of the csv, and click "Export" to convert the xjdb format file to a csv format file.</p>
file	Set stored file information
file	Set the name of the stored file, with which the system will store data
fixed file name	The stored file name is fixed, that is, the name set in the file name (the file name supports up to 200 characters)
Date Specify File Name	The stored file name is named with a date, such as the file exported on May 29, 2021, with the file name 20210529
Dynamically specify file name	Set a register address, and the stored file will be named after the contents of the register. When selecting a dynamically specified file name, you need to select a string type register such as character input and Chinese input. (File names support up to 200 characters)
storage capacity	Set the total amount of collected data information Maximum storage capacity 65535 pieces
when the storage space is insufficient	Stop saving or overwriting old records when the storage space is insufficient
stop saving	When checked, stop saving data when the storage space is insufficient
overwrite old records	When checked, when the storage space is insufficient, it will continue to save and overwrite the old records
data retention days	The default time for storing files on the screen is 1 day. After the time expires, the files will be deleted. The maximum retention time for files can be set to 1000 days
save	Set the stored items and sorting, and select serial number, alarm trigger date, alarm trigger time, alarm information, confirmation time, alarm times, and alarm recovery time



Note: Whether you choose "Fixed File Name" or "Dynamically Specify File Name" for a saved file name, the following characters are not supported for file names: \ / : * ? " < > | - # ; \$! @ & ().

4-4-2. Alarm display

Display historical alarm information in a table, allowing you to query records for a certain period of time.

1. Click alarm display icon in the menu bar "Parts/Alarm/Alarm Display" or  in the device bar of the control window, move the cursor to the screen, click the left mouse button to place, click the right mouse button, or click ESC to cancel the placement. Modify the length and width of the border through boundary points.
2. When setting attributes, you can set them in the attribute box that pops up when placing components, or you can double-click "Alarm Display" or select "Alarm Display" and right-click to select "attributes" for attribute settings.

■ Basic attributes

Control ID	It is used for system management control, and cannot be operated by users
description	Can be used to comment on the purpose of this control
alarm source	Set the source of the alarm and customize the alarm group range to be displayed (if the selection range is 0-0, only the alarm information selected for the 0th group will be displayed, and other groups will not be displayed)
use title	When checked, the table title is displayed at the top of the table
text	Edit title content
multiling	If you want the title to be displayed in multiple languages, check this option to directly launch an existing multilingual library or add a new multilingual library (see 5-1 Label Multilingual for specific usage of multilingual libraries).
font	Set the font, color, size, alignment, and row height of the table title/list title/list data. You can check to use the same font. After checking, the color, size, alignment, and line height of the three fonts should be consistent.

■ Display

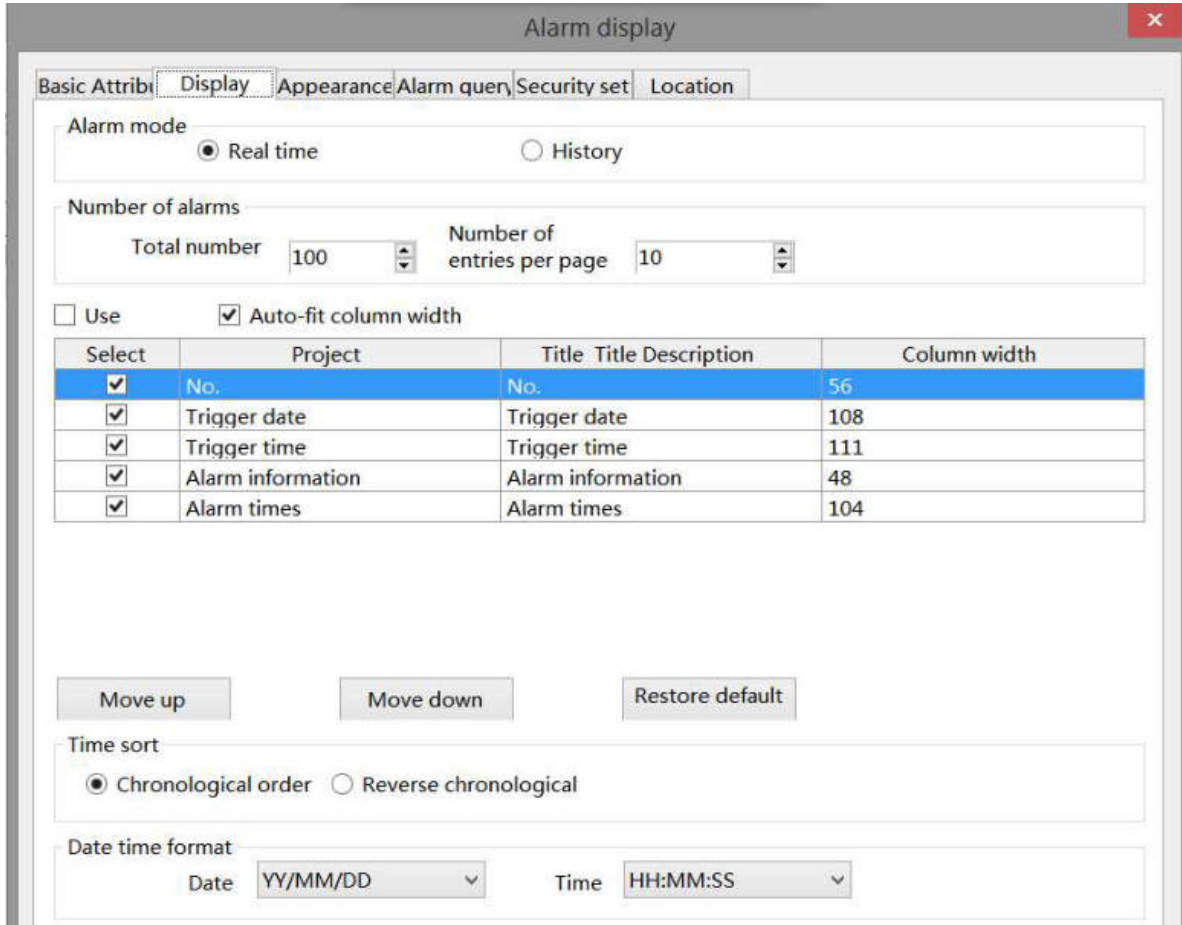

alarm mode		Select whether the information displayed in the current table is real-time or historical.															
real time		When checked, the alarm information displayed in the table is real-time alarm information display, that is, only the information currently in the alarm state is displayed, and the completed alarm information content will not be displayed.															
history		When this option is selected, the table will not only display real-time alarm information, but also display alarm information for the history of ended alarms in the table.															
number of alarms	total number	Set the total number of alarm messages displayed.															
	number of entries per page	Set the number of alarms displayed on the current page. When the number of pages per page is set to be less than the total number of pages, buttons or scroll bars are displayed on the side of the table to click or scroll to view information that is not displayed on the current page.															
information	use	After checking, click "..." below the setting bar (see the figure below) to enter multilingual settings, or the project tree - Library - Label Multilingual for management (see 5-1 Label Multilingual for specific usage). <table border="1" data-bbox="528 1809 967 1989"> <thead> <tr> <th>Title</th> <th>Title Description</th> <th>Settings</th> </tr> </thead> <tbody> <tr> <td>No.</td> <td></td> <td>...</td> </tr> <tr> <td>Trigger date</td> <td></td> <td>...</td> </tr> <tr> <td>Trigger time</td> <td></td> <td>...</td> </tr> <tr> <td>Alarm information</td> <td></td> <td>...</td> </tr> </tbody> </table>	Title	Title Description	Settings	No.		...	Trigger date		...	Trigger time		...	Alarm information		...
	Title	Title Description	Settings														
No.		...															
Trigger date		...															
Trigger time		...															
Alarm information		...															
	auto-fit	When checked, column widths cannot be customized, and the software will															

	column width	automatically adjust to the most suitable size based on the project image.
	Set the displayed information content, and you can select serial number, alarm trigger date, trigger time, alarm information, confirmation time (only available in history mode), alarm times, and alarm recovery time (only available in history mode).	
	project	Edit the display items for each column of the table.
	No.	Displays the number of the table column.
	trigger date	Date when the alarm was generated.
	trigger time	The time when the alarm occurred.
	alarm info	Preset content in alarm entry.
	confirm time	The time at which the confirmation operation was performed. (This item is not available when the mode is selected as real-time)
	alarm times	Current alarm times.
	recover time	The time when the alarm disappears. (This item is not available when the mode is selected as real-time).
	If you need to adjust the order of items, you can click the "Move Up, Move Down" button. If you need to restore the default sorting, you can click "Restore Default".	
	title description	Set the title name for each column, which is consistent with the project name by default. You can change it to a name that meets your own requirements as needed.
	column width	Set the column width for each column, which can only be modified if Auto-fit Column Width is not checked.
time sort	Set the information display mode and select whether the latest alarm is displayed before or after.	
chronological order	According to the sequence of alarm time generation, the first generated alarm information is displayed at the top and the following generated alarm information is displayed at the bottom of the table. That is, the latest alarm information is displayed at the bottom of the table.	After selecting "Display Unrecovered Alarm Information at the Top", the unrecovered alarm information will be displayed centrally at the top of the table regardless of the time sequence.
reverse chronological	In contrast to the chronological order, the alarms generated first are displayed at the bottom, and the alarms generated later are displayed at the top, that is, the latest alarm information is displayed above the table.	
date time format	Set the format of date and time.	
enable confirm	Select whether to perform information confirmation. This option is only available if the alarm mode is selected as History.	
mode	Set the method of information confirmation.	
single click	When checked, an automatic confirmation will be generated when an alarm message is clicked, and a confirmation time will be generated.	
double click	When checked, an automatic confirmation will be generated when you double-click an alarm message, and a confirmation time will be generated.	
long press	When checked, an alarm message will be automatically confirmed when long pressed, and a confirmation time will be generated.	

information hiding control	<p>After checking, specify a register to control the display of alarm information, as shown in the following figure. You can hide confirmed information, recovered information, or unrecovered information, or use them in combination (only available if the alarm mode is selected as History).</p> <div style="text-align: center;"> <input checked="" type="checkbox"/> Enable Confirm Mode <input checked="" type="radio"/> Single click <input type="radio"/> Double-click <input type="radio"/> Long press </div> <div style="margin-top: 10px;"> <input type="checkbox"/> Information hiding control Bit0 (hide confirmed information); Bit1 (hide recovered information); Bit2 (hide unrecovered informati </div> <p>The information hiding control is using the 0th, 1st, and 2nd bits of the binary system, and then input the corresponding decimal system in the set register for control.</p> <p>If the information control register is set to psw0</p> <p>Hide confirmed information: Binary: 0001; Decimal: 1, psw0 Enter 1 to hide confirmed information;</p> <p>Hide recovered information: binary: 0010; Decimal: 2, psw0 Enter 2 to hide recovered information;</p> <p>Hide unrecovered information: binary: 0100; Decimal: 4, psw0 Enter 4 to hide unrecovered information;</p> <p>To hide confirmed and recovered information: binary: 0011, decimal: 3, psw0 Enter 3 to hide;</p> <p>The rest are hidden in the same way.</p>
----------------------------	---

■ Appearance

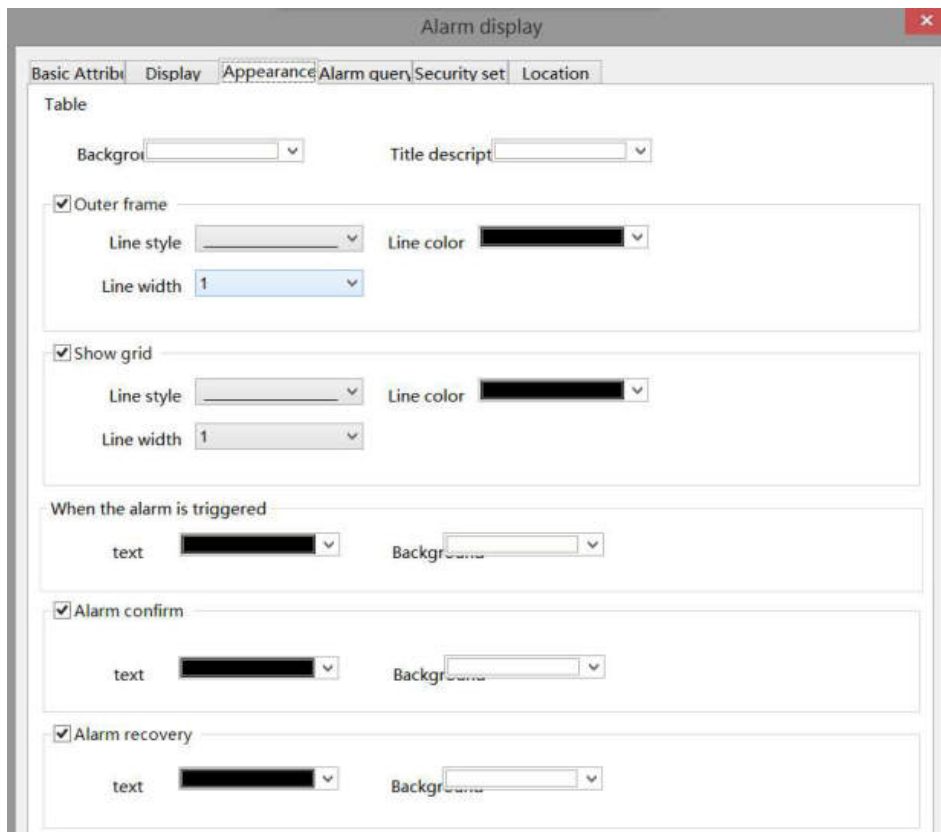

table	Set the color of the table border and background.
background	Set the background color of the entire table.
title background	Set the background color of the table header row. If the header is not checked, the setting has no

	effect.	
outer frame	Choose whether to display the table outline.	
	line style	Set the line style of the outer frame of the table. You can select straight lines, dashed lines, points, and point lines, as shown in the figure.
	line color	Set the line color for the table outline.
	line width	Set the line width of the outer frame.
show grid	Choose whether to display the grid within the table.	
	line style	Set the line style of the grid of the table. You can select straight lines, dashed lines, points, and point lines, as shown in the figure.
	line color	Set the line color for the table grid.
	line width	Set the line width of the grid.
when the alarm is triggered	Set the text display color and background color of the corresponding alarm information content when the alarm is triggered.	
	text	Set the text display color of the alarm message content.
	background	Select the background display color for the alarm message content.
alarm confirm	Set the text display color and background color of the corresponding alarm message content after alarm confirmation.	
	text	Set the text display color of the alarm message content.
	background	Select the background display color for the alarm message content.
alarm recovery	Set the text display color and background color of the corresponding alarm information content after the alarm is restored.	
	text	Set the text display color of the alarm message content.
	background	Select the background display color for the alarm message content.



Display the alarm color when an alarm occurs. Display the confirmation color when the alarm has not been restored and has been confirmed. Display the restored color when the alarm is restored and confirmed. Alarm information clearing: The internal address of the button is SPSB120, which triggers the clearing of alarm information.

■ Alarm query

① Export

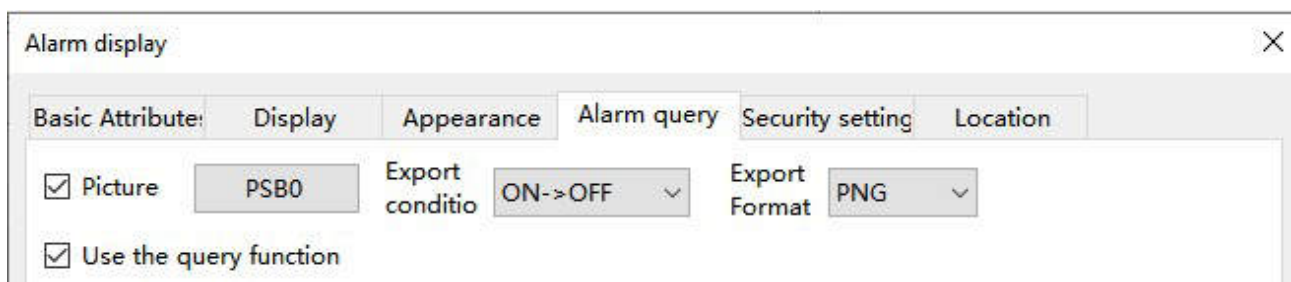

Select Picture, you can use picture export function. Meets export conditions, export format is PNG.

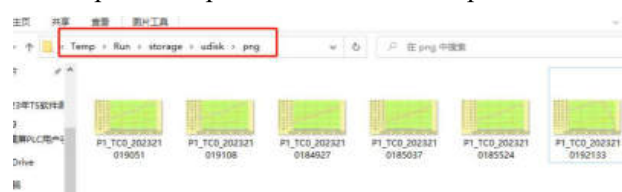

② Query

The information found will be displayed in the alarm display table. If you need to use this function, you can

directly check the Use the query function in the alarm display table.

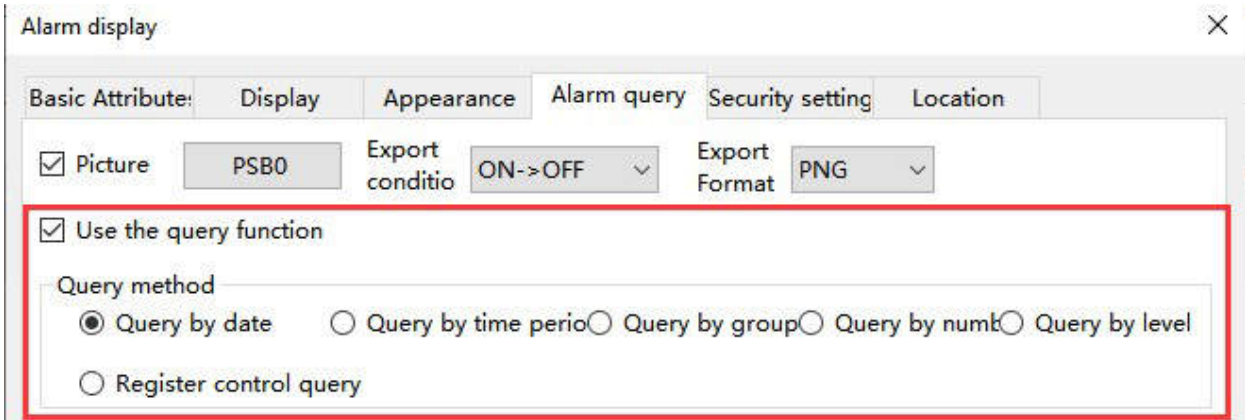

There are 5 query methods: query by date, query by time period, query by group, query by number, and query by level. The user can choose any of these five query methods, or dynamically specify the query method through registers. The specific methods are as follows:

query control	Set an address, and when set to this address, the query function will be triggered, and the query results will be displayed in the table.
---------------	---

(1) query by date

Enter the date to query, and all alarms under this date will be filtered out and displayed in the table.

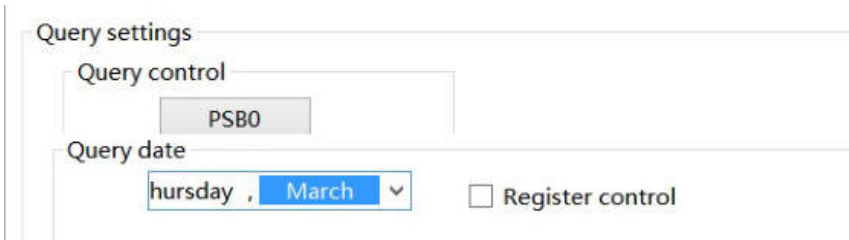

You can also select "Register Control" to dynamically set the query address. As shown in the following figure, if you set a header address, such as PSW0, the query address will occupy a total of 3 addresses from PSW0 to PSW2, where PSW0 represents the year, PSW1 represents the month, and PSW2 represents the day, all of which are single word unsigned numbers. For example, PSW0=2021, PSW1=5, and PSW2=29, the alarm record information on May 29, 2021 will be queried.

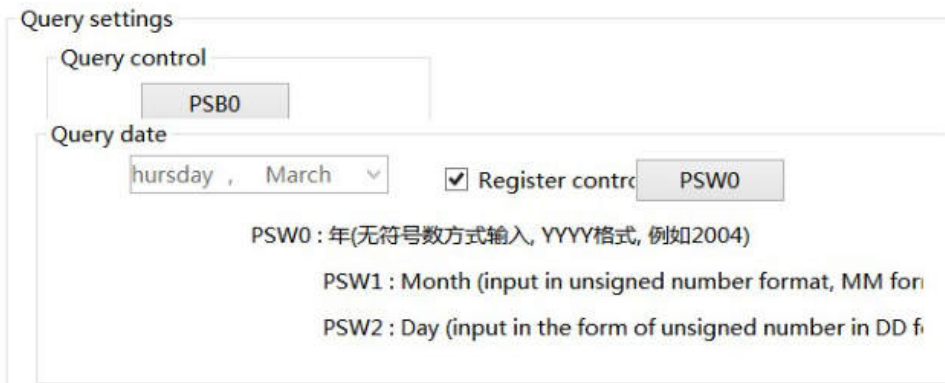

(2) Enter the start time and end time to query in the specified address, set the query control address, and

then display all the alarm information filtered out for this time period in the alarm table.

Query time period

From Thursday , March 10 Ho0 Minute Second

To Thursday , March 11 Ho0 Min26 Second

Register control

Similarly, you can also use register control. After setting the first address, 12 register addresses including the first address will be occupied. The first 6 addresses represent the year, month, day, hour, minute, second of the start time, and the last 6 addresses represent the year, month, day, hour, minute, second of the end time. The format is consistent with that set manually.

Query time period

From Thursday , March 10 Ho0 Minute Second

To Thursday , March 11 Ho0 Min26 Second

Register control PSW0

PSW0 ~ PSW5 Represent start time Year/Month/Day Ho

PSW6 ~ PSW11 Represent end time Year/Month/Day Hc

(3) Query by group

Select an alarm group, which is the newly added alarm group in the alarm login. When the query control address is triggered, the information for the specified group will be displayed in the alarm display table.

Group [dropdown] Register control

After selecting register control, you need to set a register and select the alarm group number to query in this register. This number is the alarm group number set in the alarm login. After the query trigger bit is triggered, the information of the specified group will be displayed in the alarm display table

Group [dropdown] Register control PSW0

(4) Query by number

Select the alarm number. When the query control address is triggered, the information of the specified number will be displayed in the alarm display table.

No. 0 Register control

After selecting register control, it is necessary to set a register in which to set the alarm number to be queried. After the query trigger bit is triggered, the information with the specified number will be displayed in the alarm display table

No. 0 Register control PSW0

(5) Query by level

Select an alarm level that matches the level set in the alarm login. When the query control address is triggered, the specified level of information will be displayed in the alarm display table.

Level Low Register control
Register value(0~3) represent alarm level low, normal, high

After selecting register control, you need to set a register in which to set the level to be queried. Values of 0 to 3 indicate the alarm level: Low, Normal, High, and Urgent. After the query trigger bit is triggered, the specified group of information will be displayed in the alarm display table.

Level Low Register control PSW0
Register value(0~3) represent alarm level low, normal, high

(6) register control query

Use registers to dynamically specify the query method. 0 indicates query by date, 1 indicates query by time period, 2 indicates query by group, 3 indicates query by number, and 4 indicates query by level. Users can choose according to their needs.

Query method
 Query by date Query by time period Query by group Query by number Query by level
 Register control PSW0 Register value 0:by date 1: by time period 2:by group 3:by number 4:by level

Query settings
 Query control
 PSB0
 Query register
 PSW0
 PSW0 ~ PSW11 : 根据不同的查询方式, 最多占用12个字

■ Security setting

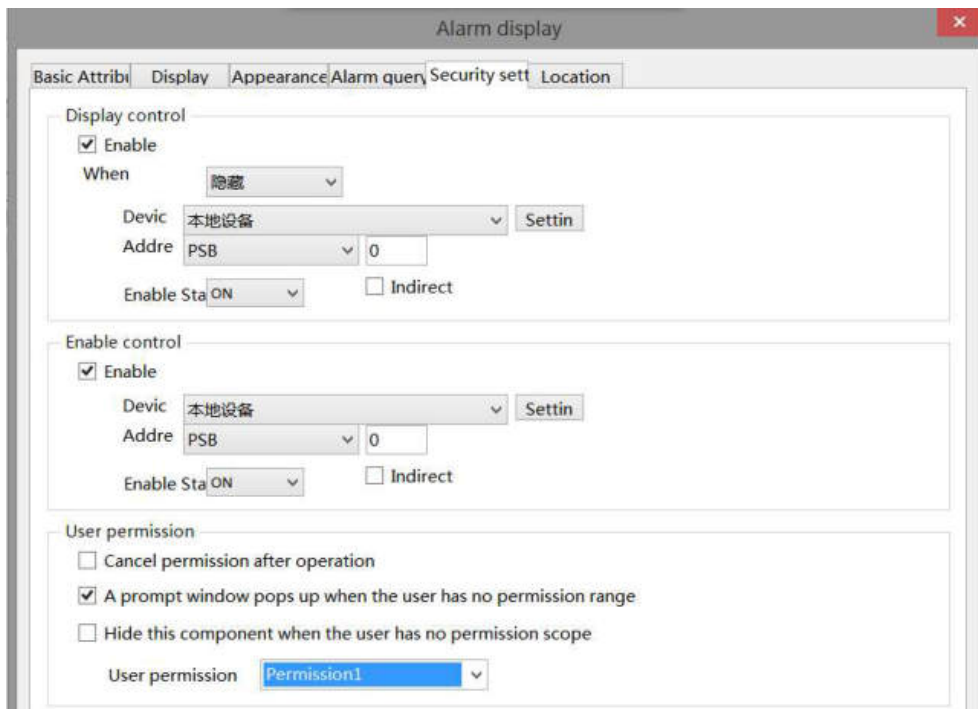

Same to chapter 4-2-10 indicator key security setting part.

■ Location

Same to chapter 4-1-1 straight line location part.

4-4-3. Alarm bar

1. Click  alarm bar icon in the menu bar or Parts/Alarm/Alarm Bar in the device bar in the control window, move the cursor to the screen, click the left mouse button to place, click the right mouse button, or click ESC to cancel the placement. Modify the length and width of the border through boundary points.
2. When setting attributes, you can set them in the attribute box that pops up when placing components, or you can double-click the "Alarm Bar" or select the "Alarm Bar" and right-click to select "attributes" for attribute settings.

■ Basic attributes

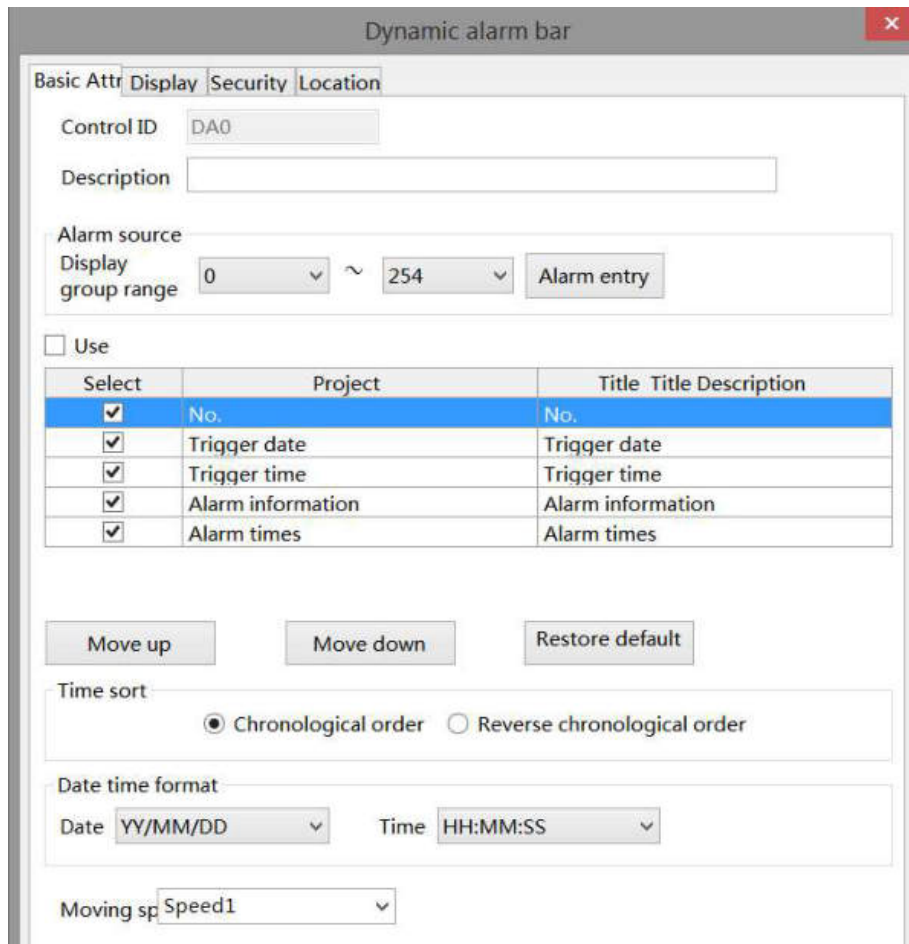

control ID	It is used for system management control, and cannot be operated by users	
description	Can be used to comment on the purpose of this control	
alarm source	Set the source of the alarm and select a group from the alarm input (if the selection range is 0-0, only the alarm information for the selected group 0 will be displayed, and other groups will not be displayed)	
use multi-language	If the alarm bar displays content in multiple languages, check this option to directly launch an existing multilingual library or add a new multilingual library (see 5-1 Label Multilingual for specific usage of multilingual libraries)	
project	Edit the display items for each column of the table	
No.	Display the sequence number of the table column	If you need to adjust the order of items, you can click the "Move Up, Move Down" button. If you need to restore the default sorting, you can click "Restore Default"
trigger date	Date when the alarm was generated	
trigger time	Time when the alarm was generated	
alarm information	Preset content in alarm entry	
alarm times	Display the total number of times this alarm occurred	
time sort	Set the information display mode and select whether the latest alarm is displayed before or after	
chronological order	According to the sequence of alarm time generation, the display generated first is displayed first, and the display generated later is displayed last, that is, the latest alarm information is displayed at the end	
reverse chronological order	Contrary to the chronological order, the alarm generated first is displayed at the bottom, and the alarm generated later is displayed at the top, that is, the latest alarm information is displayed in front of the alarm bar	

date time format	Set the date and time format
moving speed	The higher the speed number, the faster the scrolling speed



When use multiple languages is checked, "..." will be displayed in the lower right corner of the title description. Clicking it will jump to the multi language library setting interface to set multiple languages.

Use

Select	Project	Title Title Description	Settings
<input checked="" type="checkbox"/>	No.	No.	...
<input checked="" type="checkbox"/>	Trigger date	Trigger date	...
<input checked="" type="checkbox"/>	Trigger time	Trigger time	...
<input checked="" type="checkbox"/>	Alarm information	Alarm information	...
<input checked="" type="checkbox"/>	Alarm times	Alarm times	...

■ Display

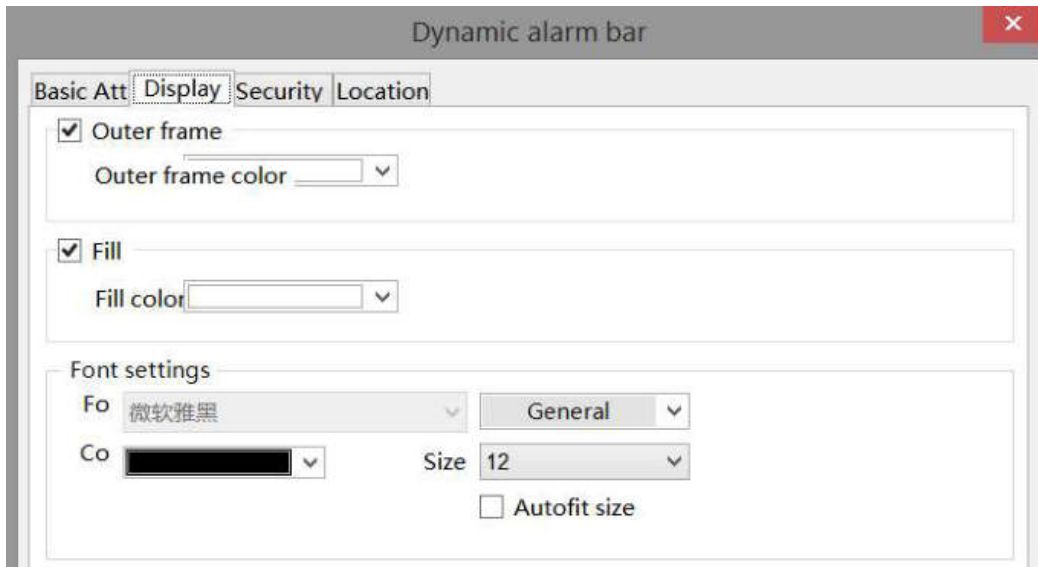

outer frame	Set the outer frame color of the dynamic alarm bar	
fill	fill color	Set the background color of the dynamic alarm bar
	transparency	You can complete the setting by sliding the slider (the closer the slider is to the left, the lower the transparency percentage, and the more transparent the component)
font setting	You can set the color, size, and alignment of the font (you can also check autofit size, which means that dragging the mouse changes the size of the component, and the text size changes accordingly)	

■ Security setting

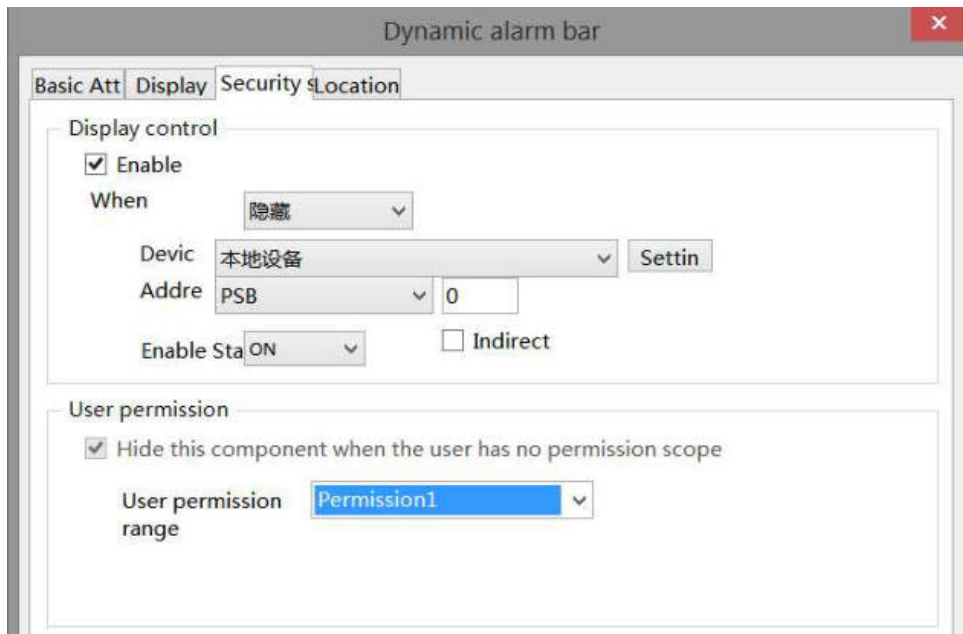

Same to chapter 4-1-1 straight line security setting part.

■ Location

Same to chapter 4-1-1 straight line location part.

4-5.Data processing

4-5-1. Data sampling

Click "Parts/Data Processing/Data Sampling" in the menu bar or click  in the toolbar to enter the data sampling setting interface, where you can add the data objects to be collected, as well as information such as object types, sampling conditions, and whether to store them. You can import/export them to a computer for use in trend charts and report displays.

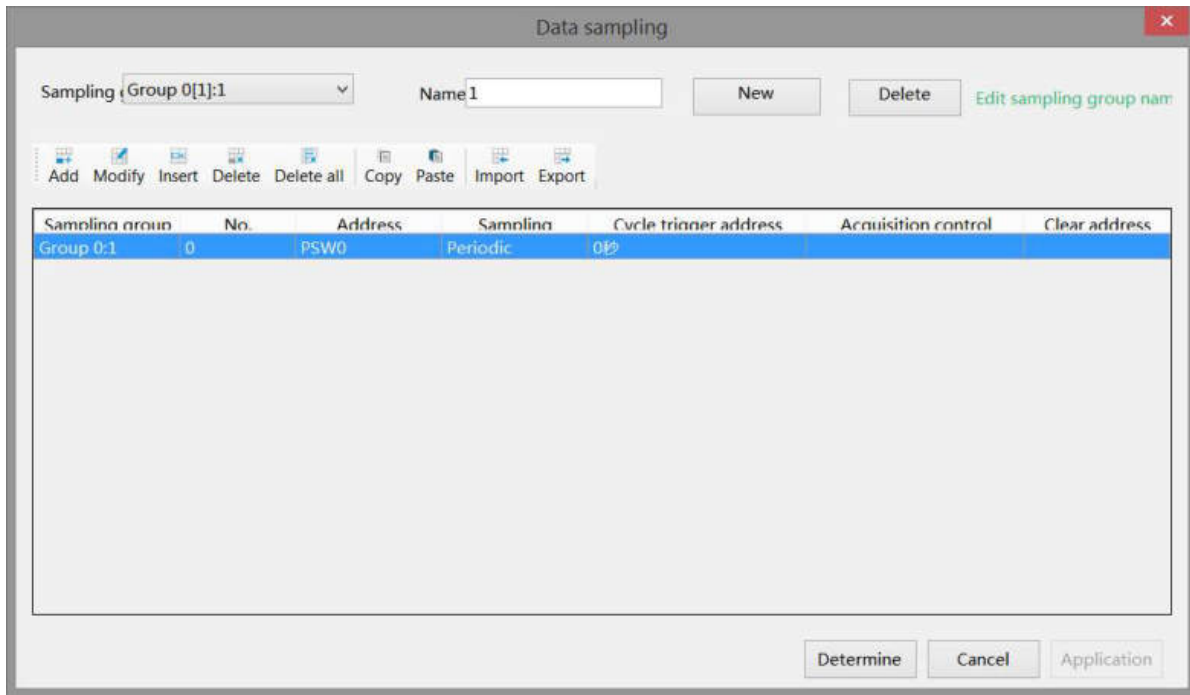

■ Sampling group

sampling group	Select the sampling group. To facilitate user management of data, we have set the classification of the group, and each group can add many collection methods
name	Set the name of the sampling group
new	Modify the name and click to add a sampling group
delete	After selecting a sampling group, click to delete the selected sampling group
edit sampling group name	Batch management of established sampling group name



Note: When creating a new sampling group for the first time, please enter a user-defined name in the "Name" field and click "New" to add a new sampling group. Otherwise, a message "Sampling Group Name cannot be blank" will be displayed.

■ Information

add	After selecting a sampling group, click Add to open the data sampling attribute setting box (see "Information Add" below for specific setting methods)
modify	Modify the selected sampling information
insert	Insert a new sampling information at the selected sampling information, optionally above or below

delete	Delete selected sampling information
delete all	Delete all sampling information for this group
copy	Copy selected sampling information
paste	Paste the copied information, and the copied information will be displayed on the last line of the current sampling group
import	Import excel file from your computer
export	Export all the sampling information edited in the software to the designated location on the computer as an Excel file

■ Add information

After clicking "Add"/"Modify", the window shown below will pop up, where you can edit the sampling information.

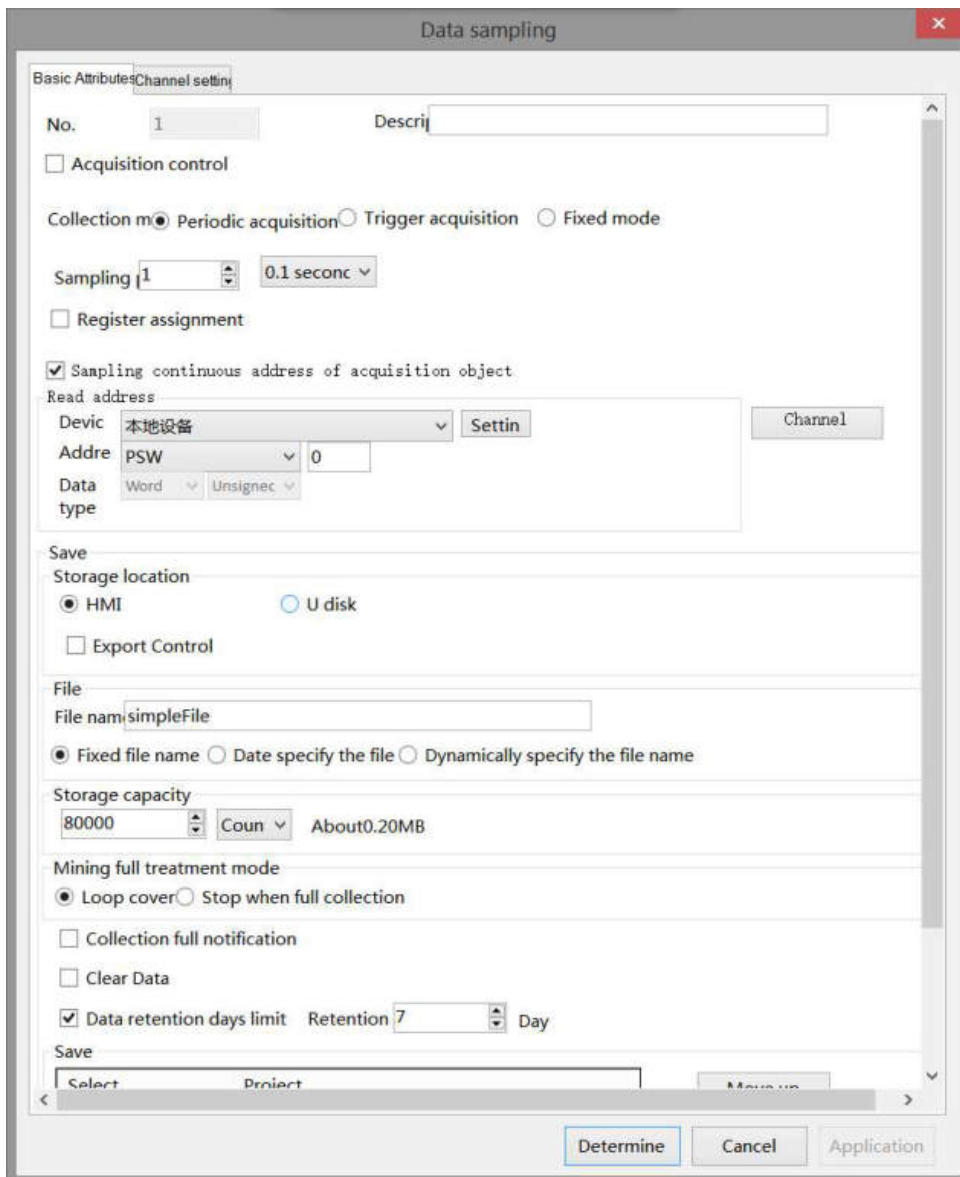

■ Basic attributes

No.	The number of this sampling group is displayed and cannot be edited
description	Set the description of the sampling group for use only as a note for project editing
acquisition control	<input checked="" type="checkbox"/> Acquisition PSB0 Acquisition OFF

	After checking, set a coil address and start collecting data only when the coil meets the collection conditions (can be set to ON/OFF)	
acquisition condition	select on or off 	
collection mode	periodic acquisition	Set the mode, cycle, trigger or fixed mode of data collection Collect with a fixed cycle, and set the sampling time. The sampling units are (0.1 seconds/second/minute) Collection m <input checked="" type="radio"/> Periodic acquisition <input type="radio"/> Trigger acquisition <input type="radio"/> Fixed mode Sampling <input type="text" value="1"/> <input type="text" value="0.1 secon"/> <input type="text" value="c"/> <input type="text" value="v"/> <input checked="" type="checkbox"/> Register assignment <input type="text" value="PSW0"/> <p>Register control can be selected. After selecting the sampling unit, change the register value to change the acquisition cycle.</p>
	trigger acquisition	Use address control for acquisition, and you can select a word address or a bit address. Word address trigger acquisition: After selecting a word address, you can set the conditions to "<", ">", "<=", ">=", "==", "!=" a fixed value to take effect. If you do not need a fixed value, you can select register assignment to dynamically specify the value. Collection m <input type="radio"/> Periodic acquisition <input checked="" type="radio"/> Trigger acquisition <input type="radio"/> Fixed mode <input checked="" type="radio"/> Word <input type="radio"/> bit Read add <input type="text" value="PSW0"/> Cond <input type="text" value="<"/> <input type="text" value="0"/> <input type="checkbox"/> Register assignment Bit address trigger acquisition: After selecting a bit address, you can set the condition to "ON ->OFF", "OFF ->ON" to take effect. <input type="radio"/> Word <input checked="" type="radio"/> bit Read add <input type="text" value="PSB0"/> Cond <input type="text" value="ON->OFF"/> <input type="text" value="v"/> <input type="text" value="ON->OFF"/> <input type="text" value="OFF->ON"/>
	fixed mode	Set a fixed time period for collection only Collection m <input type="radio"/> Periodic acquisition <input type="radio"/> Trigger acquisition <input checked="" type="radio"/> Fixed mode Time from <input type="text" value="16"/> <input type="text" value="Ho"/> <input type="text" value="33"/> <input type="text" value="Minute"/> <input type="text" value="16"/> <input type="text" value="Ho"/> <input type="text" value="34"/> <input type="text" value="Minute"/> Sampling frequency <input type="text" value="0.1 secc"/> <input type="text" value="v"/> <input checked="" type="checkbox"/> Register assignment <input type="text" value="PSW0"/> <p>For example, if the time is from 8:00 to 12:00, the system will automatically perform the acquisition from 8:00 to 12:00, with a minimum sampling period of 0.1 seconds. You can also use registers to specify the sampling period. When "Register Assignment" is selected, only the time period can be changed, and the unit of sampling frequency can only be 0.1 seconds/second/minute, which cannot be modified (for example, when the unit of sampling frequency is set to seconds, and the register is checked to specify the address as PSW0, when 10 is entered into PSW0, it means that the sampling period is now 10 seconds).</p>

Sampling continuous address of acquisition object

Add the address of the data object that needs to be sampled. If the sampling address is continuous, you can directly set the first address on the current page. Click "Channel Settings" on the right to enter the channel setting interface. Click Add Channels, and the system will automatically list them in order based on the user-defined data type. Channel settings will be described in detail below. If the sampling address is not continuous, you can uncheck "sampling continuous address of acquisition object", Click "Channel" on the right to set the address in the channel, as shown in the following figure

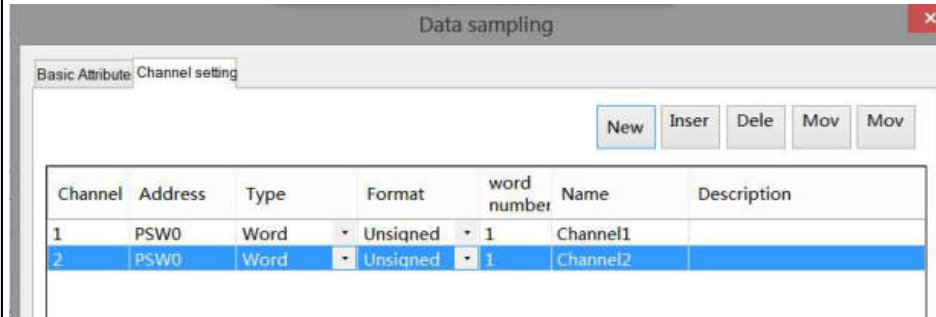

read address	device	Device port currently communicating
	address	Set Target Register Number
	data type	The default value is Word unsigned and cannot be modified. To modify the channel data type, click "Channel Settings" to change it
	setting	Click "Settings" to enter the address setting interface. This interface allows you to set and use system registers and user-defined tags. You can click the address tag library or project tree - library - address tag library below to set the tags used (see 5-2 Address Tag Library for the use of address tag library and user-defined tags)
operation items	new	add sampling channel
	insert	Insert a new channel below the selected channel
	delete	delete the selected channel
	move up	Move the selected channel up
	move down	Move the selected channel down
channel setting	channel	Incremental by default and cannot be modified
	address	You can customize settings only if "Sampling continuous address of acquisition object" is not checked. If it is checked, the system will automatically increment based on the first address and data type.
	type	Byte-8Bit, Word-16Bit, DWord- 32Bit, DDWord -64Bit
	format	BCD-BCD format, Hex format, Signed number, Unsigned number, Floating

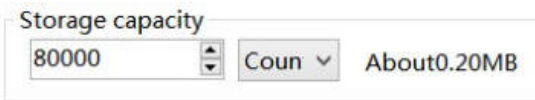
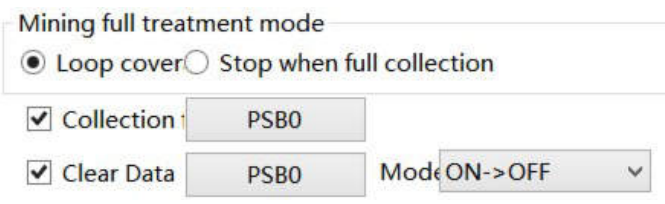
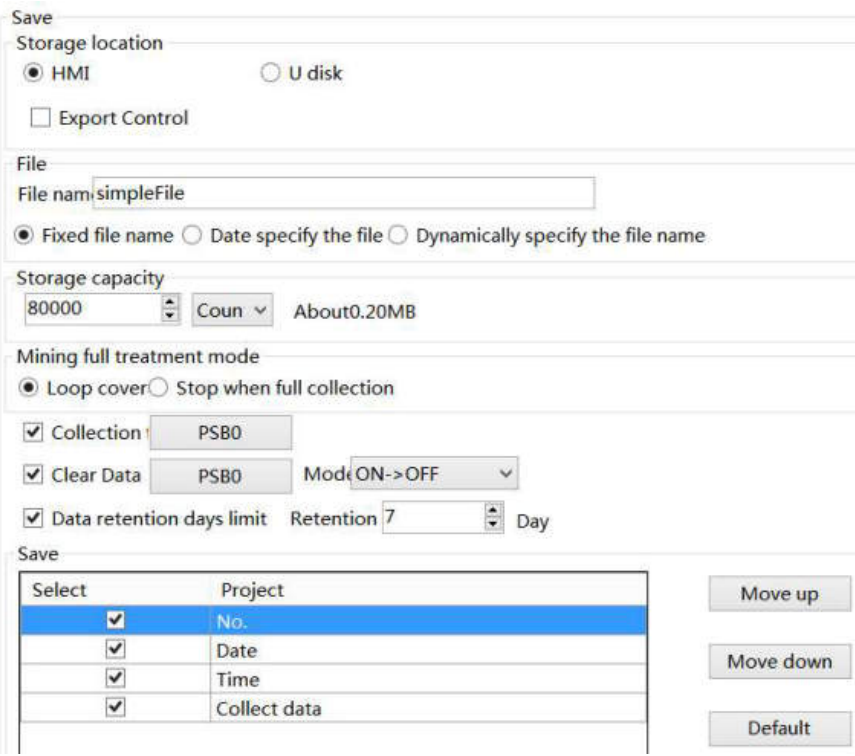
		number			
	word number	Based on the selected data type, the system will automatically increment and cannot be modified			
	description	Custom description text			
storage	set the mode of data storage				
	storage capacity	 <p>Set the total amount of collected data information stored. The selectable unit is "count" or "MB". Regardless of which unit is selected, the software will automatically convert it to another unit and display it later.</p>			
	loop cover	The collection will continue after reaching the set capacity, and the touch screen will delete the earliest collected data to store new data			
	mining full treatment mode	<p>When the acquisition reaches the set storage capacity, the storage is full</p>  <table border="1"> <tr> <td>collection notice</td> <td>Set a coil, and when the acquisition reaches the set capacity, set on the coil</td> </tr> <tr> <td>clear data</td> <td>Set a coil and select the clearing method. When the set conditions are met, the collected data will be cleared (the conditions can be set to "ON ->OFF", "OFF ->ON")</td> </tr> </table>	collection notice	Set a coil, and when the acquisition reaches the set capacity, set on the coil	clear data
collection notice	Set a coil, and when the acquisition reaches the set capacity, set on the coil				
clear data	Set a coil and select the clearing method. When the set conditions are met, the collected data will be cleared (the conditions can be set to "ON ->OFF", "OFF ->ON")				
save	<p>To set the storage location, you can select HMI or USB flash disk, or use a register to specify the storage location. For example, if you set the register PSW0, then when PSW0=1, the storage location is HMI; When PSW=3, the storage location is a USB flash drive</p> 				

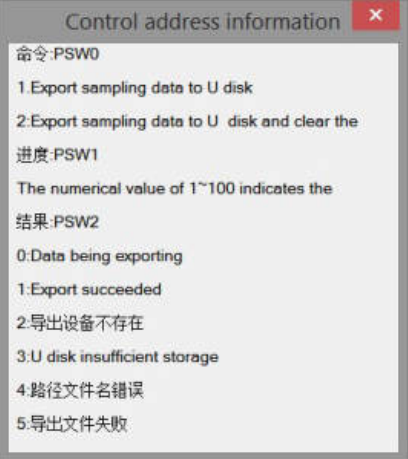
	 Storage location of sampling information during simulation: <ul style="list-style-type: none"> (1) Save to USB flash drive: Software directory Temp/Run/storage/udisk/sample (2) If you choose to save to the HMI: software directory Temp/Run/db/sample, the saved file in this saving method cannot be directly opened for viewing. To view, you need to export to a USB flash drive through the export control register, and then view the exported file in the path saved to the USB flash drive
export control	Set the register for HMI export control (if set to PSW0, three consecutive addresses with PSW0 as the first address control different states), and click "Control Address Information" to preview  Note: <ul style="list-style-type: none"> 1. This function only takes effect when the storage location is selected as HMI or specified as HMI using "Register Specified Storage Location". 2. When inputting 1 or 2 to the command register, the database can be controlled to be exported to a USB flash drive, and the exported file format is xjdb. The xjdb to csv convert tool can be opened by double clicking on the software root directory \Tool\XJDbTool\XJDbTool.exe, which is set as the default opening method for xjdb. After opening, enter the path name of the csv, and click "Export" to convert the xjdb format file to a csv format file.
file name	Set the name of the stored file, with which the system will store data
fixed file name	The stored file name is fixed, that is, the name set in the file name (the file name supports up to 200 characters)
date specify the file	The stored file name is named with a date, such as the file exported on May 29, 2021, with the file name 20210529
dynamically specify the file name	Set the register address, and the stored file will be named after the contents of the register. When selecting a dynamically specified file name, you need to select a string type register such as character input and Chinese input. (File names support up to 200 characters)
storage capacity is not enough	Stop saving or overwriting old records when the storage space is insufficient
stop when full collection	When checked, stop saving data when the storage space is insufficient
loop cover	When checked, when the storage space is insufficient, it will continue to save and overwrite the old records
data retentive	The default time for storing files on the screen is 7 days. After that time, the files will be deleted. File

days limit	retention time can be set to a maximum of 1000 days
save content	Set the stored items and sorting. The saved content can be selected from serial number, date, time, and collected data. You can move the saved content up, down, and restore the default sorting operation.



Note: Whether you choose "Fixed File Name" or "Dynamically Specify File Name" for a saved file name, the following characters are not supported in the file name: \ / : * ? " < > | - # ; \$! @ & ().

■ Channel setting

Set the data source of the current sampling group. When the address of the selected collection object is continuous, the address column cannot be edited, and the system automatically increments based on the data type of the previous row of data. The address column can only be edited if “sampling continuous address of acquisition object” is not checked.

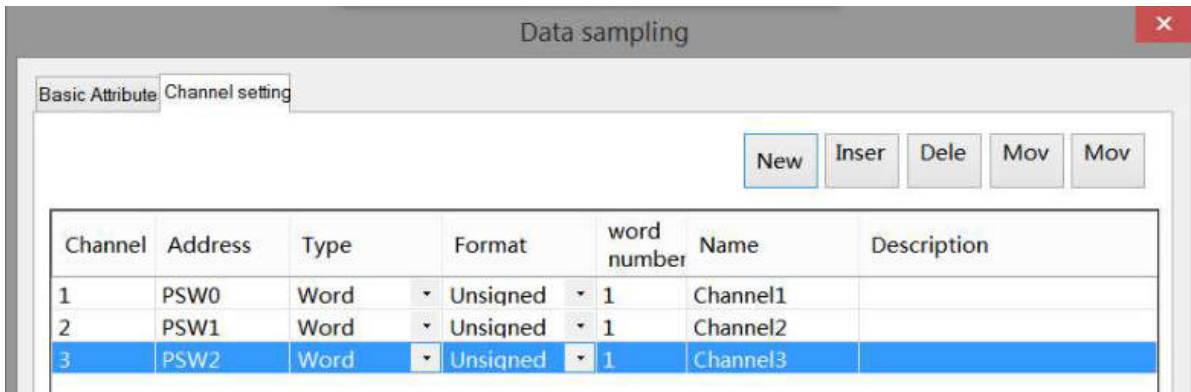

4-5-2. Trend map

Display the data collected during data sampling in the form of a curve, and query the data within a certain time range.



1. Click trend chart icon in the menu bar or click "Parts/Data Processing/Trend Chart" in the device bar in the control window, move the cursor to the screen, click the left mouse button to place, click the right mouse button, or click ESC to cancel the placement. Modify the length and width of the border through boundary points.
2. When setting attributes, you can set them in the attribute box that pops up when placing components. You can also double-click on "Trend Chart" or select "Trend Chart" and right-click to select "Properties" to set attributes.

■ Basic attributes

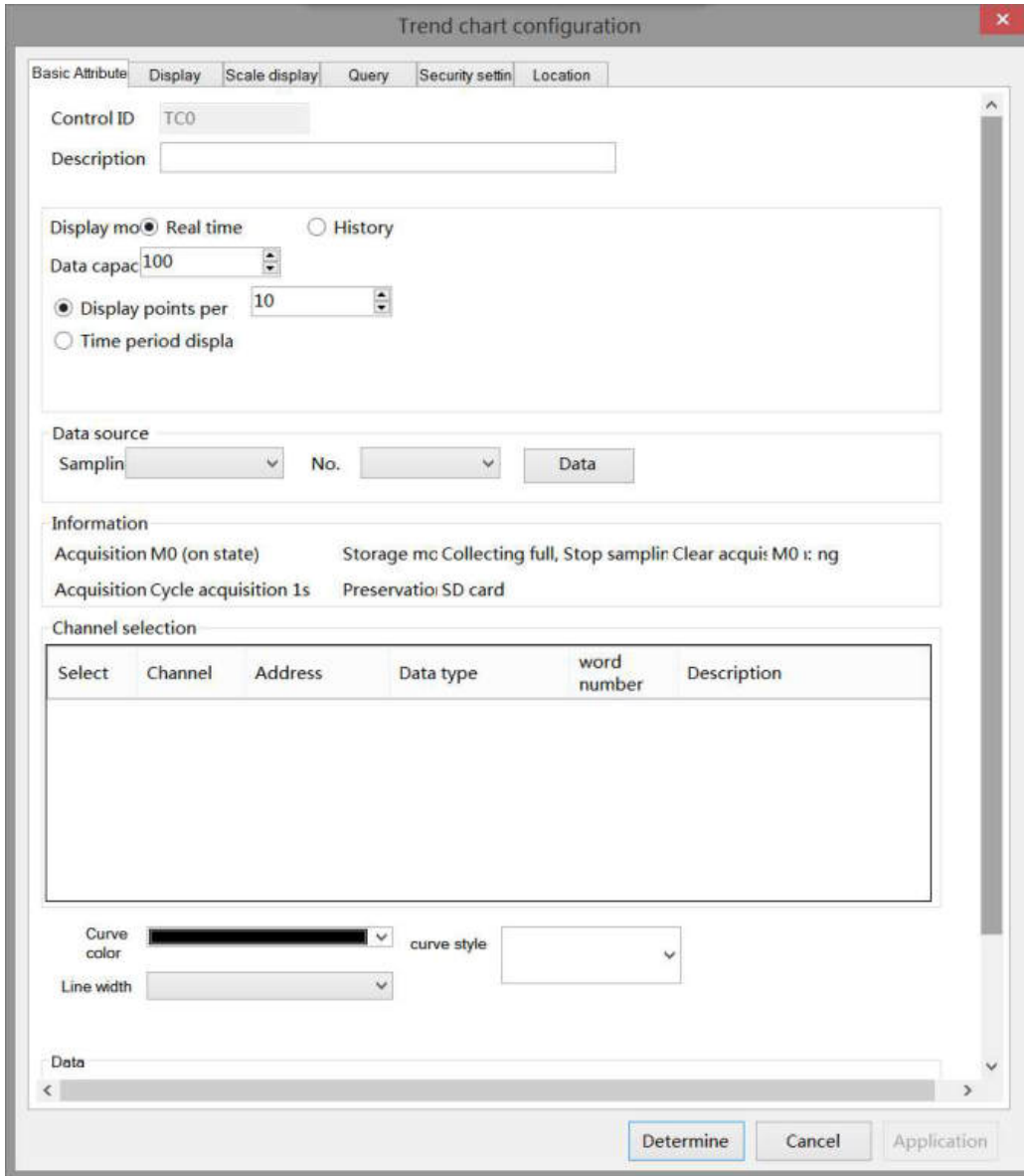

control ID	It is used for system management control, and cannot be operated by users
description	Can be used to comment on the purpose of this control
display mode	Select whether the data displayed in the trend chart is real-time or historical data
data capacity	Set the maximum number of points displayed in the trend graph (the maximum data capacity of a single channel is 5000)
display points per screen	Set the number of data points on the current display page of the trend chart (the maximum data capacity of a single channel is 5000). When the number of points per screen is set to be less than the maximum number of points, a button or scroll bar is displayed below the curve to click or scroll to view the curve that is not displayed on the current page
time period display per screen	Set the time displayed on the current display page of the trend chart. The unit can be customized, with a minimum unit of 0.1 seconds.

	<p>Display mode <input checked="" type="radio"/> Real time <input type="radio"/> History</p> <p>Data capacity <input type="text" value="100"/></p> <p><input type="radio"/> Display points per</p> <p><input checked="" type="radio"/> Time period display <input type="text" value="1"/> <input type="text" value="0.1 secc"/></p>												
data source	<p>Select the data group to display as a curve from the data sampling</p> <p>Data source</p> <p>Sampling <input type="text"/> No. <input type="text"/> <input type="button" value="Data"/></p>												
information	<p>Display some collection control information for the selected data group and cannot be edited. If you need to edit it, you can click "Data" in the data source row to enter the data sampling section for editing</p> <p>Information</p> <p>Acquisition Mode (on state) Storage mode Collecting full, Stop sampling Clear acquisition Mode: ng</p> <p>Acquisition Cycle acquisition 1s Preservation SD card</p>												
channel selection	<p>Select the data channels to display from the sampling group, and each channel is displayed as a separate curve. Uncheck those that do not need to be displayed</p> <p>Channel selection</p> <table border="1"> <thead> <tr> <th>Select</th> <th>Channel</th> <th>Address</th> <th>Data type</th> <th>word number</th> <th>Description</th> </tr> </thead> <tbody> <tr> <td colspan="6" style="height: 100px;"> </td> </tr> </tbody> </table> <p>Curve color <input type="text" value="black"/> curve style <input type="text"/></p> <p>Line width <input type="text"/></p> <p>Data</p> <p>Max value <input type="text" value="0"/> <input type="checkbox"/> Register assignment</p> <p>Min value <input type="text" value="0"/> <input type="checkbox"/> Register assignment</p>	Select	Channel	Address	Data type	word number	Description						
Select	Channel	Address	Data type	word number	Description								
curve color	Set the curve color of the selected channel												
curve style	Select the curve style of the selected channel, including polylines, points, and dotted lines												
line width	Set the line width of the selected channel												
data	Set the curve display maximum and minimum values for the selected channel. You can set fixed data or select register assignments												

■ Display

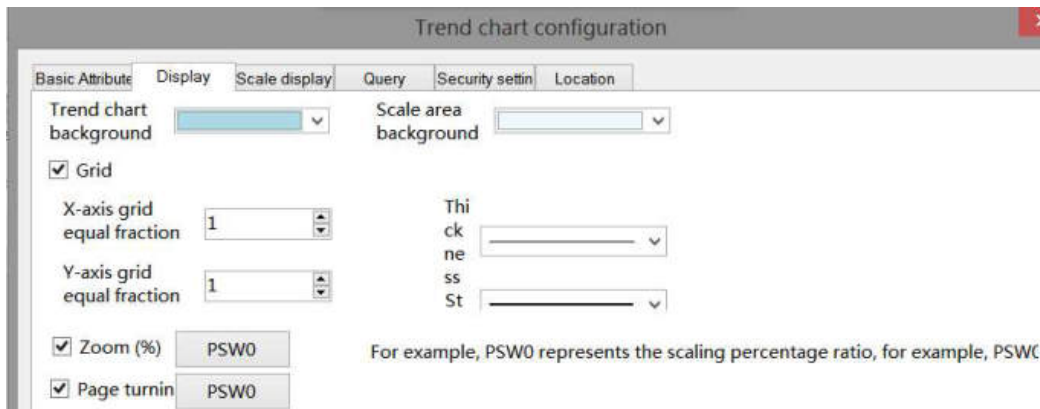

trend chart background	Set the background color of the trend chart	
scale area background	Set the background color of the scale area	
grid	Set whether to display the grid	
X-axis grid equal fraction	Set the number of grid divisions for the X axis	
Y-axis grid equal fraction	Set the number of grid divisions for the Y axis	
grid style	Set the grid style, including solid lines, dotted lines, point lines, and thick lines	
color	Set grid color	
Numerical display * Display the coordinates of the selected point	When selecting the historical mode, clicking a point on the trend chart will display the current value of the point, as shown below.	
		
	show items	Set the items to display. Such as date, time, channel, etc
	content description	Customizable display content
	select	If checked, it can be displayed; if unchecked, it will not be displayed
	background color	Set the background color of the information window
	font color	Set the font color
data line color	When selecting a point, in order to visually display the point information, the screen will automatically make an auxiliary line perpendicular to the X axis for the selected point. This setting is used to set the color of the auxiliary line	
zoom	<p>Select whether to scale the curve. After checking, set the register address to represent the scaling ratio with the register value</p> <p><input checked="" type="checkbox"/> Zoom (%) PSW0 For example, PSW0 represents the scaling percentage ratio, for example, PSWC</p> <p><input checked="" type="checkbox"/> Page turning PSW0</p>	
page turning	Set the register address to dynamically control the page turning of the curve based on the register value	

■ Scale display

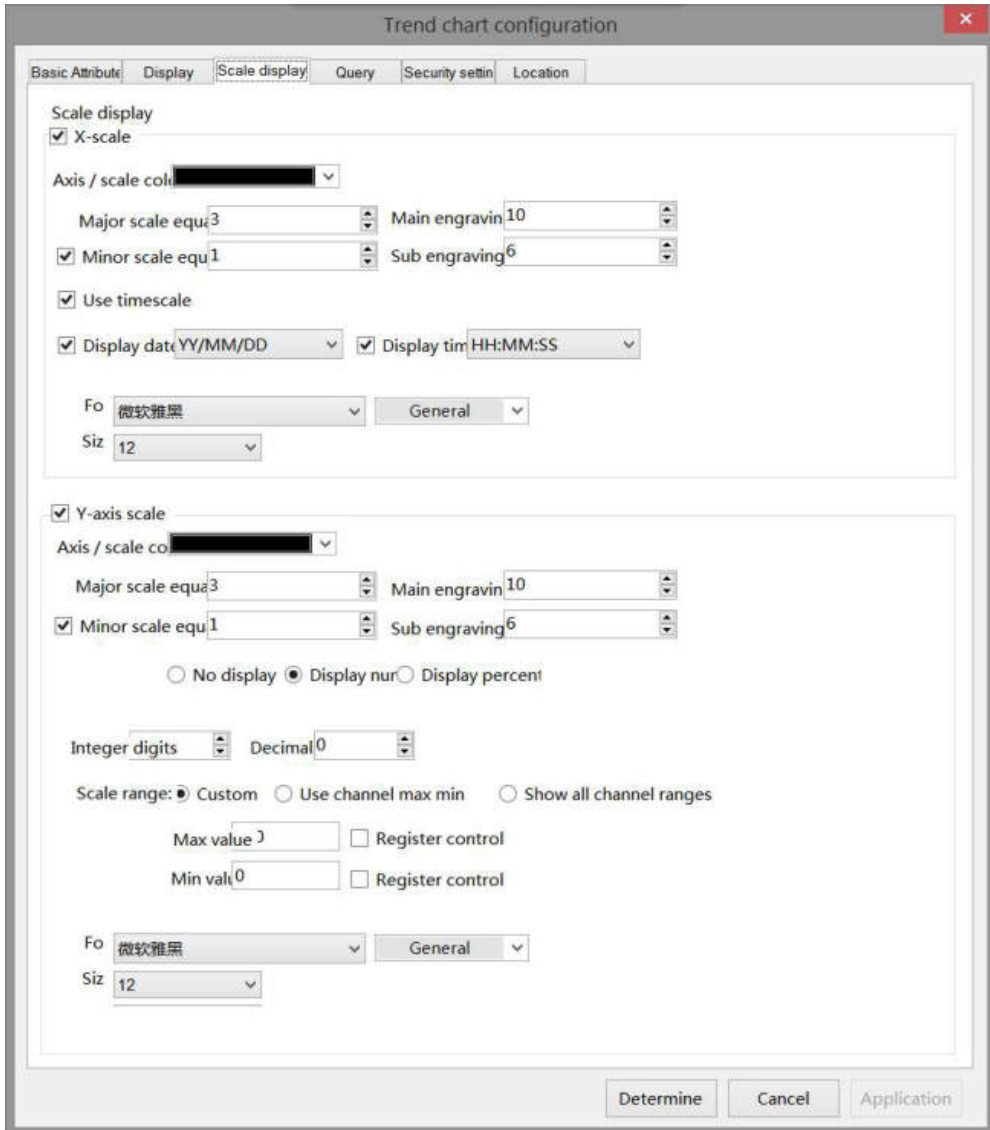

X scale	axis/scale color	Set the display color for the X axis and scale
	major scale segment	Set the number of segments for the X-axis major divisions
	main scale length	Set the display length of the major divisions
	sub scale segment	When checked, the sub scale will be displayed on the control, where the number of sub scale segments is set
	sub scale length	Set the display length of the sub scale
use time scale	When checked, it will be displayed in the control with a time scale	
display date	When checked, the date will be displayed on the time scale	
display time	When checked, the time will be displayed on the time scale	
font	Set the font for scale display	
size	Set the size of the scale display text	
Y scale	axis/scale color	Set the display color for the Y axis and scale
	major scale segment	Set the number of segments for the Y-axis major divisions
	main scale length	Set the display length of the major divisions

	sub scale segment	When checked, the sub scale will be displayed on the control, where the number of sub scale segments is set
	sub scale length	Set the display length of the sub scale
	scale style	Choose whether to display scale marks, which is the style of display. You can choose to display numbers or percentages, or not to display them
	integer bit	After selecting the display flag, you can set the integer digits displayed as needed
	decimal bit	Set the number of decimal places to display numbers as needed
	scale range	Set the maximum and minimum values for scale display (1) Use a custom range that can be set as a constant or specified through a register (2) Use the maximum and minimum values in the channel (3) Show all channel ranges
	font	Set the font for scale display
	size	Set the size of the scale display text

■ Query

① Export

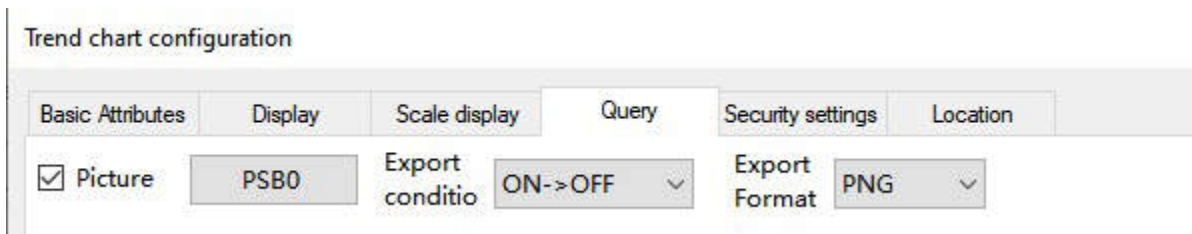

Select Picture to use picture export function. Meets export conditions, export format is PNG.

② Query

After checking Use the query function, you can use the query function to filter data based on conditions and display it in the current trend graph.

There are three ways to query: query by date, query by time period, and query by channel. You can also use register control to query.

(1) Query by Date: Enter the date to query. After the query control bit is turned on, the filtered results will be automatically displayed.

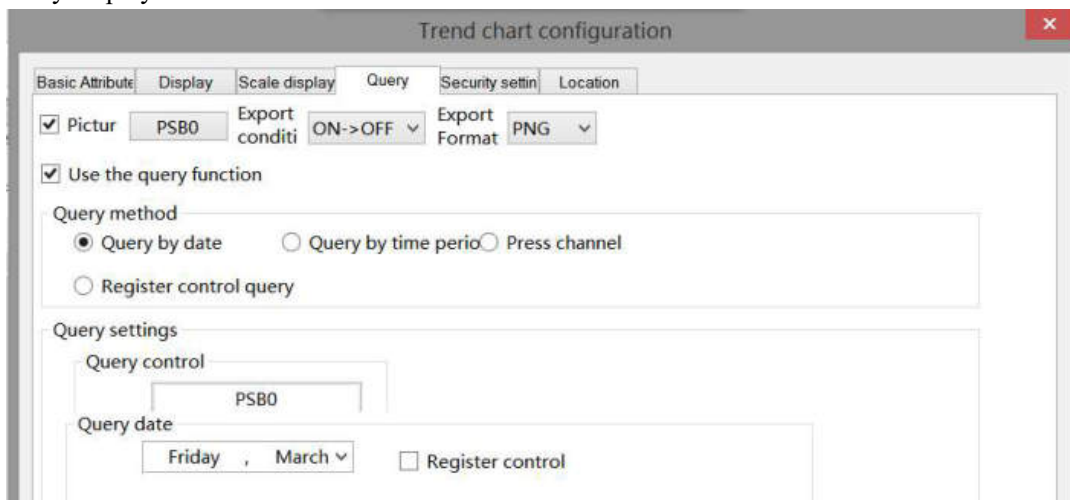

You can also select "register control query" to dynamically set the query address. As shown in the following

figure, if you set a header address, such as PSW0, the query address will occupy a total of 3 addresses from PSW0 to PSW2, where PSW0 represents the year, PSW1 represents the month, and PSW2 represents the day, all of which are single word unsigned numbers. For example, PSW=2021, PSW2=5, and PSW3=29, the data collection record information on May 29, 2021 will be queried.

Query date

Friday , March Register control PSW0

For example: PSW0: year (unsigned number input, YYYY format, f
 PSW1: Month (unsigned number input, mm format, for ex
 PSW2: Day (unsigned number input, DD format, for exam

(2) Query by time period: Enter the start time and end time to query. After the query trigger bit is turned on, the filtered results will be automatically displayed.

Query method

Query by date Query by time period Press channel

Register control query

Query settings

Query control

PSB0

Query time period

From Friday , March 10 Ho 34 Minute Secc

To Friday , March 11 Ho 34 Min 6 Secc

Register control

Similarly, you can also use register control. After setting the first address, 12 register addresses, including the first address, will be occupied. The first 6 addresses represent the year, month, day, hour, minute, and second of the start time, and the last 6 addresses represent the year, month, day, hour, minute, and second of the end time. The format is consistent with that manual setting.

Query time period

From Friday , March 10 Ho 34 Minute Secc

To Friday , March 11 Ho 34 Min 6 Secc

Register control PSW0

Example: PSW0~PSW5: from time year, month, day,
 PSW6~PSW11: refers to the time year, month, da

(3) Query by channel: Select or dynamically specify the number of channels to query the records of corresponding channels.

Query method

Query by date Query by time perio Press channel

Register control query

Query settings

Query control

PSB0

Query channel

Channel Register control

(4) Register control query: Determine the query method based on different register values. When the value is 0, query by date. When the register value is 1, query by time period. When the register value is 2, query by channel.

Query method

Query by date Query by time perio Press channel

Register control query PSW0 Register value 0: by date 1: by time period 2: by channel

Query settings

Query control

PSB0

Query register

PSW0

Example: PSW0~PSW11: According to different query methods, it can take up to 12

■ Security setting

Trend chart configuration

Basic Attribute Display Scale display Query Security setting Location

Display control

Enable

When

Device

Address

Enable Station Indirect

User permission

Cancel permission after operation

A prompt window pops up when the user has no permission range

Hide this component when the user has no permission scope

User permission range

Same to chapter 4-2-10 indicator key security setting part.

■ Location

Same to chapter 4-1-1 straight line location part.

4-5-3. XY line chart

By collecting data from two consecutive sets of registers on the site, one or more consecutive sets of coordinate points are formed, and graphs are drawn and displayed in the form of points, lines, or dotted lines, which is beneficial for the on-site engineer to analyze the accuracy of the data.



1. Click  icon in the menu bar or click "Parts/Data Processing/XY Line Chart" in control window device bar, move the cursor to the screen, click the left mouse button to place, click the right mouse button, or press ESC to cancel the placement. Modify the length and width of the border through boundary points.
2. When setting attributes, you can set them in the attribute box that pops up when placing components. You can also double-click the "XY Line Chart" or select the "XY Line Chart", right-click, and select "Attributes" to set attributes.

- Basic attributes

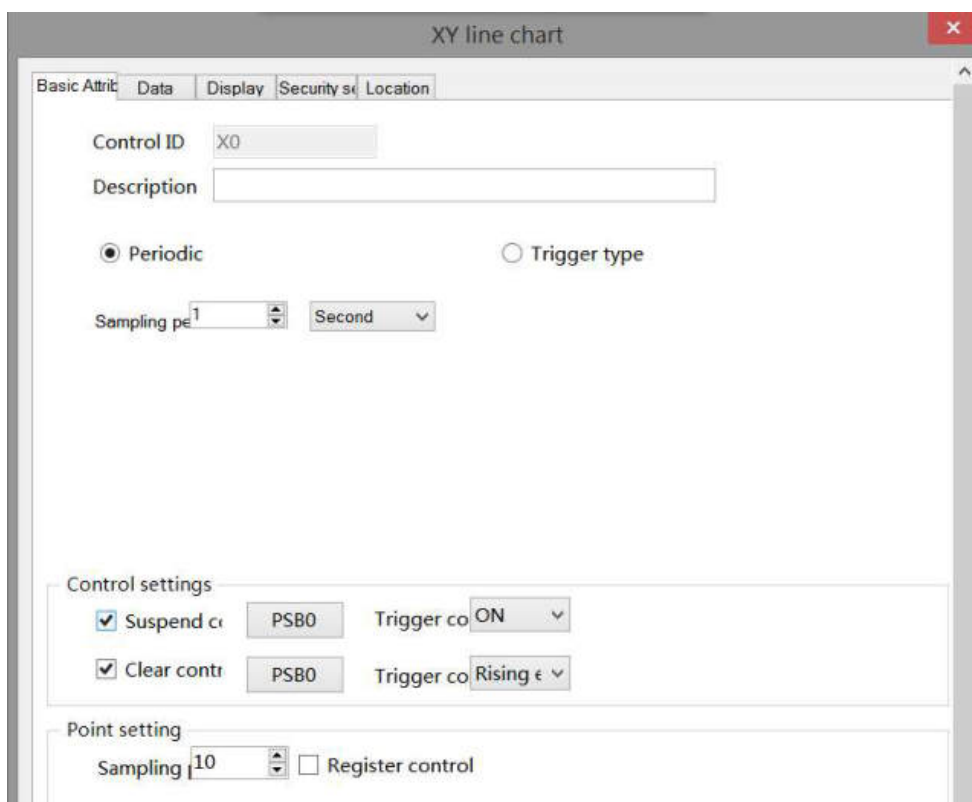

control ID		It is used for system management control and cannot be operated by users.
description		Can be used to comment on the purpose of this control.
sampling mode	periodic	Set the sampling period and collect it regularly according to the cycle time. The cycle time defaults to 1 second, and can be adjusted as needed (collection unit: 0.1 second/second/minute).
	trigger type	Set a bit register and select the rising or falling edge as the trigger condition. When the address reaches the trigger condition, a piece of information is collected.

	device	The device port that is currently communicating.
	address	Set the target coil number.
	setting	Click "Settings" to enter the address setting interface, where you can set the use of system registers and user-defined tags. You can click the address tag library or the project tree - library - address tag library below to set the used tags (see 5-2 Address Tag Library for the use of address tag library and user-defined tags).
	indirect specify	Set the current address offset. The current coil address changes with the indirectly specified register value, that is, $Dx [Dy]=D [x+Dy \text{ value}]$ ($x, y=0, 1, 2, 3\dots$). Example: The current coil address is PSB0, if the indirectly specified address is PSW100; When the value of the PSW100 register is 0, the coil that controls this element remains PSB0; When the value of the PSW100 register is 1, the coil that controls this element is PSB1 (and so on).
control settings	suspend control	Set a bit register and select the trigger condition to be ON or OFF. When the address reaches the trigger condition, acquisition will be suspended.
	clear control	Set a bit register and select the rising or falling edge as the trigger condition. When the address reaches the trigger condition, the collected information will be cleared.
point setting	sampling points	Set the maximum number of points for curve sampling (the maximum number of points is 1024), which can be checked as register control. After selecting register control, the value in the register will prevail.

■ Data

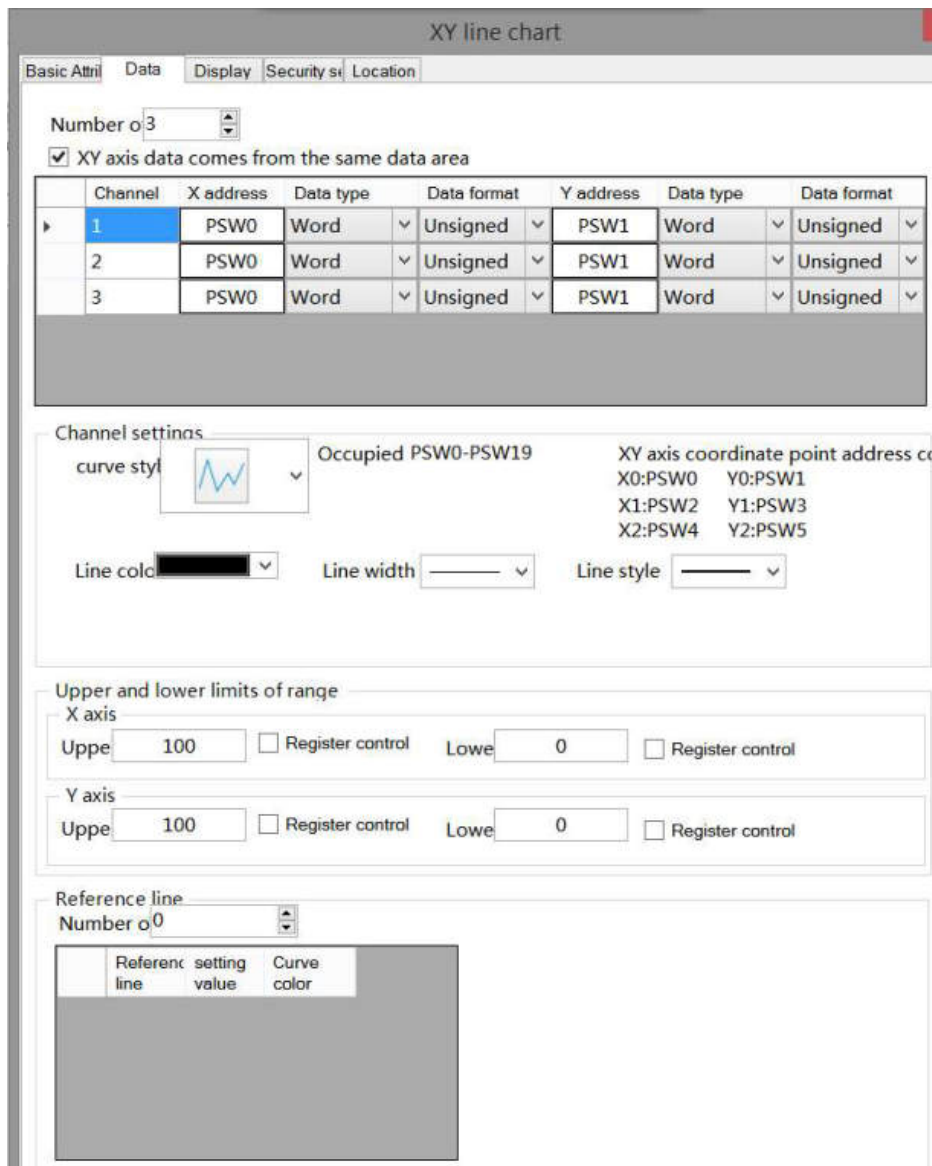

number of channel	Set the number of channels (the maximum number of channels is 16), and each channel corresponds to a curve (by clicking  , the number of channels below will increase or decrease accordingly).
XY axis data comes from the same area	If X and Y are selected from the same data area, assuming the set address is n, the coordinates of data point 1 are (n, n+1), data point 2 is (n+2, n+3), and data point 3 is (n+4, n+5)..... If X and Y are not selected from the same data area, assuming that the address set for the X axis is a and the address set for the Y axis is b, the coordinates of data point 1 are (a, b), data point 2 is (a+1, b+1), and data point 3 is (a+2, b+2).....
	X address Set the object for the X axis.
	Y address Set the object of the Y axis (can be set when XY axis comes from the same data area is not checked).
	data type Set the data type of the collection object. You can choose from 8-bit, 16-bit, 32-bit, or 64-bit data types.
	data format Set the data format of the collection object, and you can select decimal, hexadecimal, floating point, and unsigned numbers.
channel setting	Each channel can be set with a different curve style, line color, width, and line type.
upper and lower	Display range of X and Y axis data objects.

limits of range	X axis	upper limit: Set the maximum value of X-axis data, which can be specified by register.
		lower limit: Set the minimum value of X-axis data, which can be specified by register.
	Y axis	upper limit: Set the maximum value of Y-axis data, which can be specified by register.
		lower limit: Set the minimum value of Y-axis data, which can be specified by register.
reference line	Select whether to set a reference curve, and set coordinate points and curve colors. The coordinate points can be dynamically specified by the register.	

■ Display

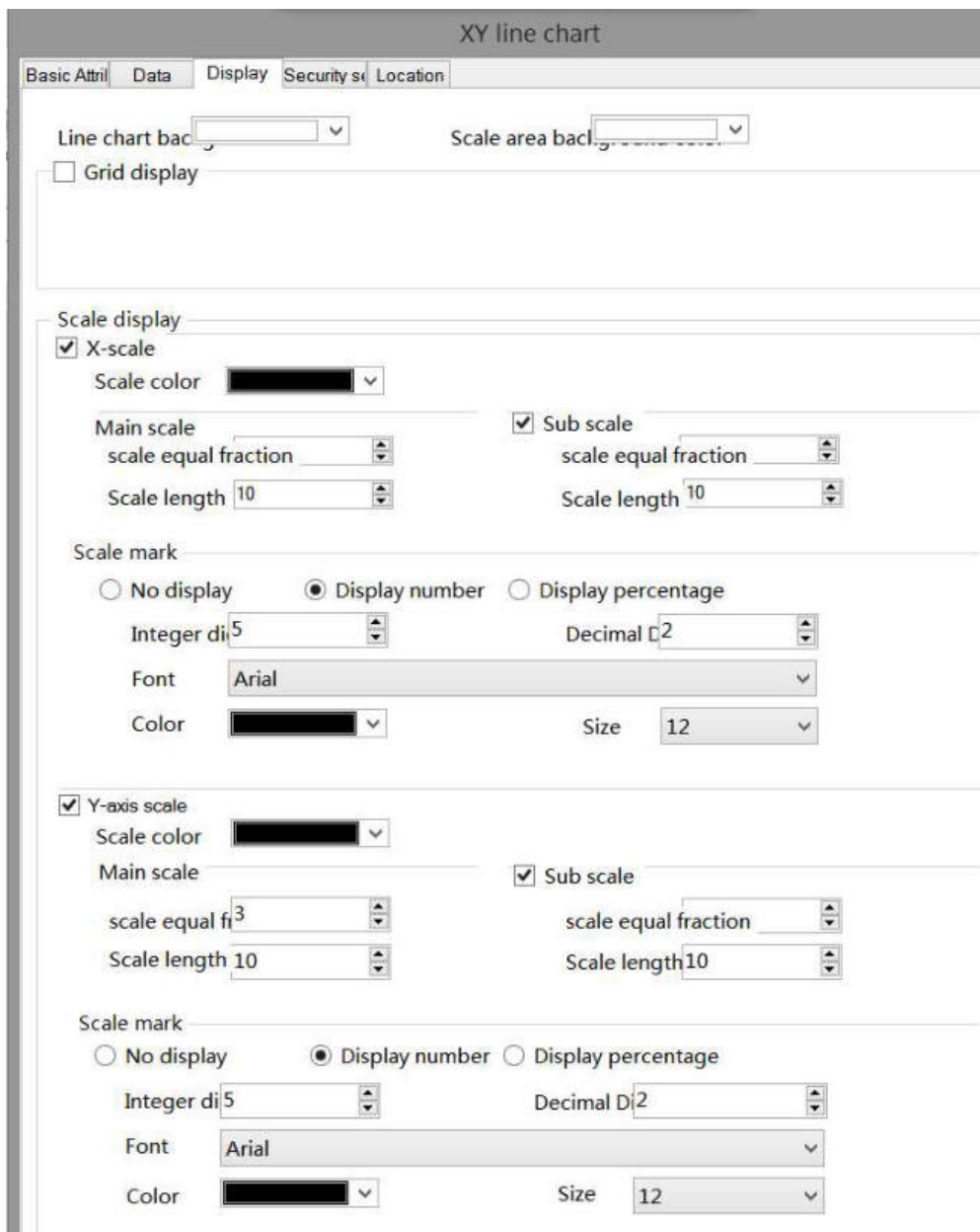

line chart background color	Set the background color of the line chart.
scale area background color	Set the background color of the scale area.

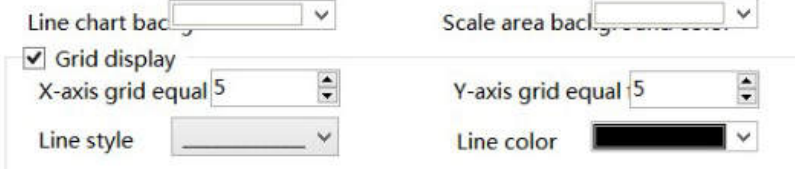
grid display		Set whether the grid is displayed.		
grid display	X axis grid equal	Sets the number of grid divisions for the X axis.		
	Yaxis grid equal	Sets the number of grid divisions for the Y axis.		
	line style	Set the line style, including solid line, dotted line, dot line, thick line, and so on.		
	line color	Set the grid color. 		
scale display	X scale	Scale Color	Sets the display color for the X axis and scale.	
		main scale equal fraction	Set the X axis main scale segments	
		main scale length	Set the main scale display length	
		sub scale equal fraction	after checking, display sub scale on the control, set the sub scale segments	
		sub scale length	Set the sub scale display length	
	scale mark	Select whether to display scale marks, which is the display style. You can choose to display numbers, percentages, or not.		
		integer bit	After selecting the display flag, you can set the integer digits displayed as needed.	
		decimal bit	Set the number of decimal places to display numbers as needed.	
		font	Set the font for the scale display.	
		size	Set the size of the scale display text.	
		color	Set the color of the scale display text.	
	Y scale	scale color	Set the display color for the Y axis and scale.	
		main scale equal fraction	Set the Y axis main scale segments	
		main scale length	Set the main scale display length	
		sub scale equal fraction	after checking, display sub scale on the control, set the sub scale segments	
sub scale length		Set the sub scale display length		

■ Security setting

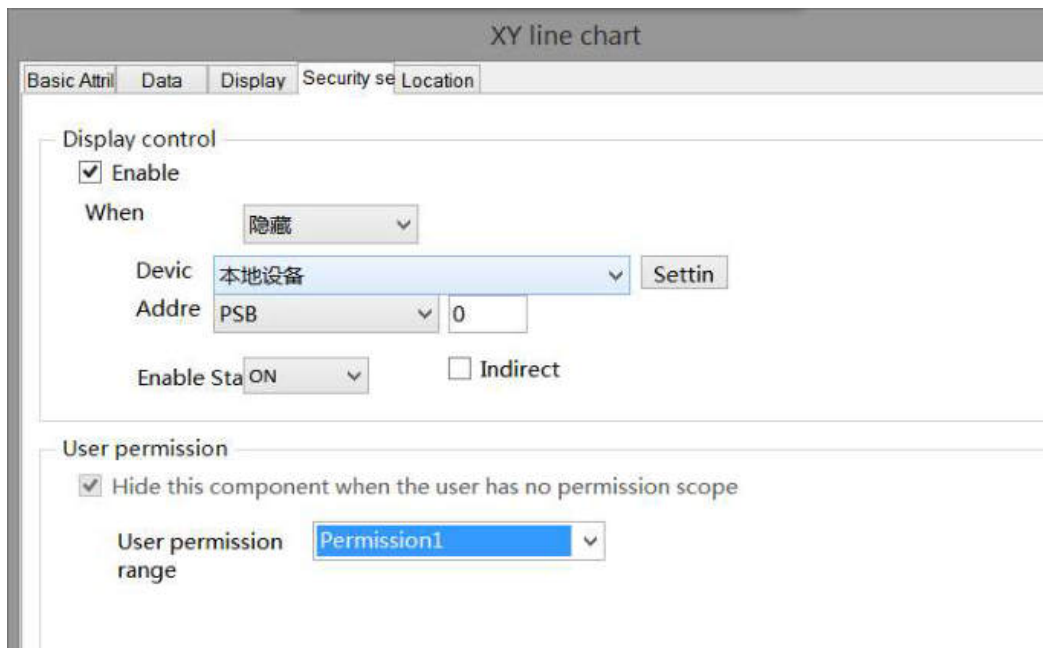

Same to chapter 4-1-1 straight line security setting part.

- Location

Same to chapter 4-1-1 straight line location part.

4-5-4. XY trend chart

1. Click the  XY trend chart display icon in the control window device bar or "Parts/Data Processing/XY Trend Chart" in the menu, move the cursor to the screen, click the left mouse button to place, click the right mouse button, or click ESC to cancel the placement. Modify the length and width of the border through boundary points.
2. When setting attributes, you can set them in the attribute box that pops up when placing components. You can also double-click on the "XY Trend Chart" or select the "XY Trend Chart", right-click, and select "Attributes" to set attributes.

- Basic attributes

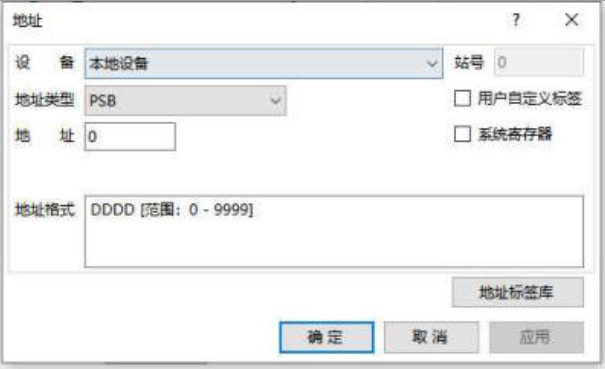

control ID		It is used for system management control, and cannot be operated by users
description		Can be used to comment on the purpose of this control
Refresh mode	Periodic acquisition	Set the sampling period and collect it regularly according to the cycle time. The cycle time defaults to 0.1 seconds, which can be adjusted as needed (collection unit: 0.1 seconds/second/minute)
	Trigger acquisition	<p>Set a register and select the trigger condition. When the address reaches the trigger condition, a message is collected.</p> <p>Word address trigger acquisition: After selecting a word address, you can set the conditions to "<", ">", "<=", ">=", "=", "!=" a fixed value to take effect. If you do not need a fixed value, you can select register assignment to dynamically specify the value.</p> <p>Bit address trigger acquisition: After selecting a bit address, you can set the condition to the rising edge or falling edge to take effect.</p>
	device	Device port currently communicating
	address	Set target coil number
	setting	Click "Settings" to enter the address setting interface. This interface allows you to set and use system registers and user-defined tags. You can click the address tag library or project tree - library - address tag library below to set the tags used (see 5-2 Address Tag Library for the use of address tag library and user-defined tags)

		
	indirect specify	Set the current address offset. The current coil address changes with the indirectly specified register value, that is, $Dx [Dy]=D [x+Dy \text{ value}]$ ($x, y=0, 1, 2, 3\dots$). Example: The current coil address is PSB0, if the indirectly specified address is PSW100; When the value of the PSW100 register is 0, the coil that controls this element remains PSB0; When the value of the PSW100 register is 1, the coil that controls this element is PSB1 (and so on)
point setting	sampling points	Set the maximum number of points for curve sampling, which can be checked as register control. After selecting register control, the value in the register will prevail
	Acquisition and processing method	Set the collection status when the sampling points are fully collected, stop sampling, clear the data, and resample or cycle over
	Upper and lower limits of range	Set the upper and lower limits of the XY axis, which can be specified through registers

■ Data



channel numbers	Each channel corresponds to a curve. You can edit the channel by clicking Add Channel and Delete Channel
X address	Set the data type and format of the X-axis address
Y address	Set the data type and format of the Y-axis address
data type	Set the data type of the collection object. You can select 8-bit, 16-bit, 32-bit, or 64-bit data types
data format	Set the data format of the collection object, and you can select decimal, hexadecimal, floating point, and unsigned numbers
curve style	After selecting a channel, you can set the display style of the curve, the thickness, style, and color of the curve line
reference line	Click on the add/delete button to add/delete reference lines. The coordinate value of the reference line cannot be a decimal
description	User defined description content
curve color	Set the color of the reference line
curve mode	Two display modes for lines or points
Coordinate point	Set the coordinate points of the reference line

■ Display

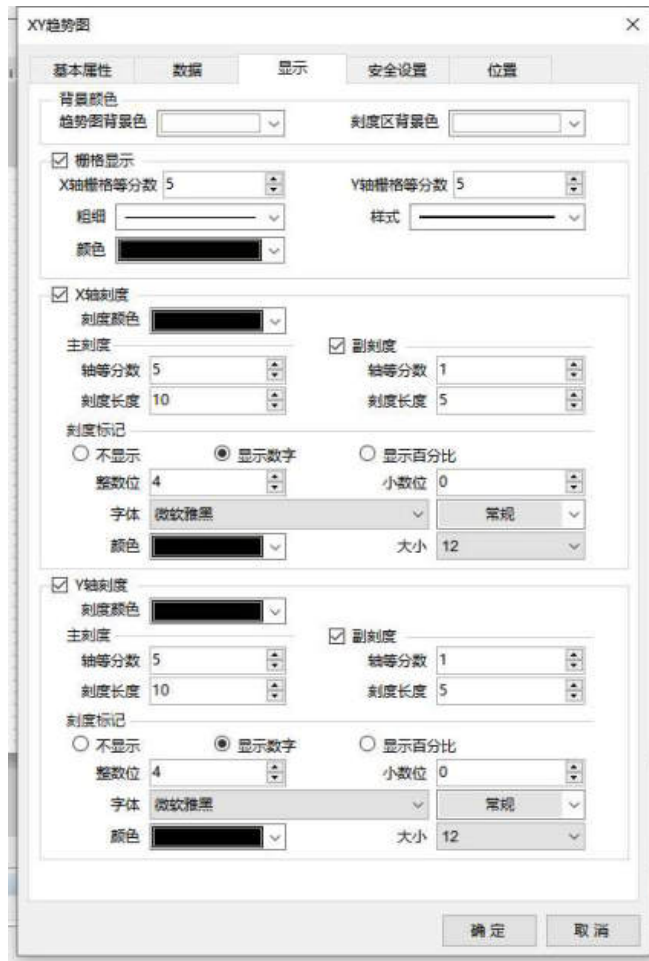

trend chart background color		Set the background color of the trend chart	
scale area background color		Set the background color of the scale area	
grid display		Set whether to display a grid	
grid display	X-axis grid equifraction	Set the number of grid divisions on the X-axis	
	Y-axis grid equifraction	Set the number of grid divisions on the Y-axis	
	thickness	Set the thickness of grid lines	
	style	Set the style of grid lines, including solid lines, dashed lines, dotted lines, thick lines, etc	
	color	Set the color of grid lines	
scale display	X/Y axis scale	scale color	Set the display color of the X/Y axis and scale
		main scale equifraction	Set X/Y axis main scale segments
		main scale length	Set main scale display length
		sub scale equifraction	After checking, display sub scale on the control, set the sub scale segments
		sub scale length	Set sub scale display length
scale mark	Choose whether to display the scale mark, which is the displayed style. You can choose to display numbers, percentages, or not		

		integer bit	After selecting the display flag, you can set the number of integer digits displayed as needed
		decimal bit	Set the decimal places for displaying numbers as needed
		font	Set the font for scale display
		size	Set the size of the scale display text
		color	Set the color of the scale display text
	Y scale	scale color	Set the Y axis scale color
		main scale equifraction	Set the Y axis scale segments
		main scale length	Set the main scale display length
		sub scale equifraction	After checking, display sub scale on the control, set the sub scale segments
		sub scale length	Set sub scale display length

■ Security setting



Same to chapter 4-1-1 straight line security setting part.

■ Location

Same to chapter 4-1-1 straight line location part.

4-5-5. Report form

Display the records stored in data sampling in a table format, allowing for querying data within a certain time range.



1. Click the  icon in the control window, or click Parts/Data Processing/Report form in the menu, move the cursor to the screen, click the left mouse button to place, click the right mouse button or use the ESC key to cancel the placement. Modify the length and width of the border through the boundary point.
2. When setting attributes, you can set them in the attribute box that pops up when placing components. You can also double-click on "Report form" or select "Report form" and right-click to select "attributes" for attribute settings.

■ Basic attributes

Report form

Basic Attributes Display Appearance Query Security settings Location

Control ID

Description

Sampling No.

list selection

Selec	Char	Address	Data type	Data format	Integer digits	Decimal digits	Encoding format	word number	Alignmer	Display color
<input checked="" type="checkbox"/>	1	PSW0	Word	Unsign...	4	0	/	/	Center	<input type="text" value=""/>
<input checked="" type="checkbox"/>	2	PSW1	Word	Unsign...	4	0	/	/	Center	<input type="text" value=""/>
<input checked="" type="checkbox"/>	3	PSW2	Word	Unsign...	4	0	/	/	Center	<input type="text" value=""/>

Channel settings

Integer dig Decimal d Leading 0

Alignment Color

Display serial number

Number of digits Color

Time

Display date Color

Display tim Color

Data capacity

Max lines Lines per

control ID	Used for system management controls, user cannot operate
description	Can be used to annotate the purpose of this control
sampling group	Select the data to be displayed from the data sampling and display it by group. If you need to modify the sampling data, you can click on "Data" on the right to enter the data sampling page for modification.
list selection	Select the channels that need to be displayed from the sampling group. The default is to select all. If there are any channels that do not need to be displayed, you can uncheck them. Each channel occupies one column of data display.
channel settings	Set the integer and decimal places displayed for each channel, whether to lead with 0, alignment, and text color.
display serial number	Choose whether to display the sequence number column. If you choose to display it, the automatically incremented sequence number will be displayed in the first column of the table.
number of digits	Set the number of digits displayed in the sequence number column, with a default of 3 digits.
color	Set the color for displaying text in the sequence number column.
time	Choose whether to display the time column.

display date	Set the date display format.	
color	Set the color of the date display text.	
display time	Set the time display format.	
color	Set the color of the time display text.	
data capacity	max lines	Set the maximum number of rows displayed in the table (up to 5000 rows).
	lines per page	Set the number of data rows on the current display page of the table. When the collected rows exceed the set number of rows per screen, there is a moving bar below the trend chart to control the page turning of the trend chart.

■ Display

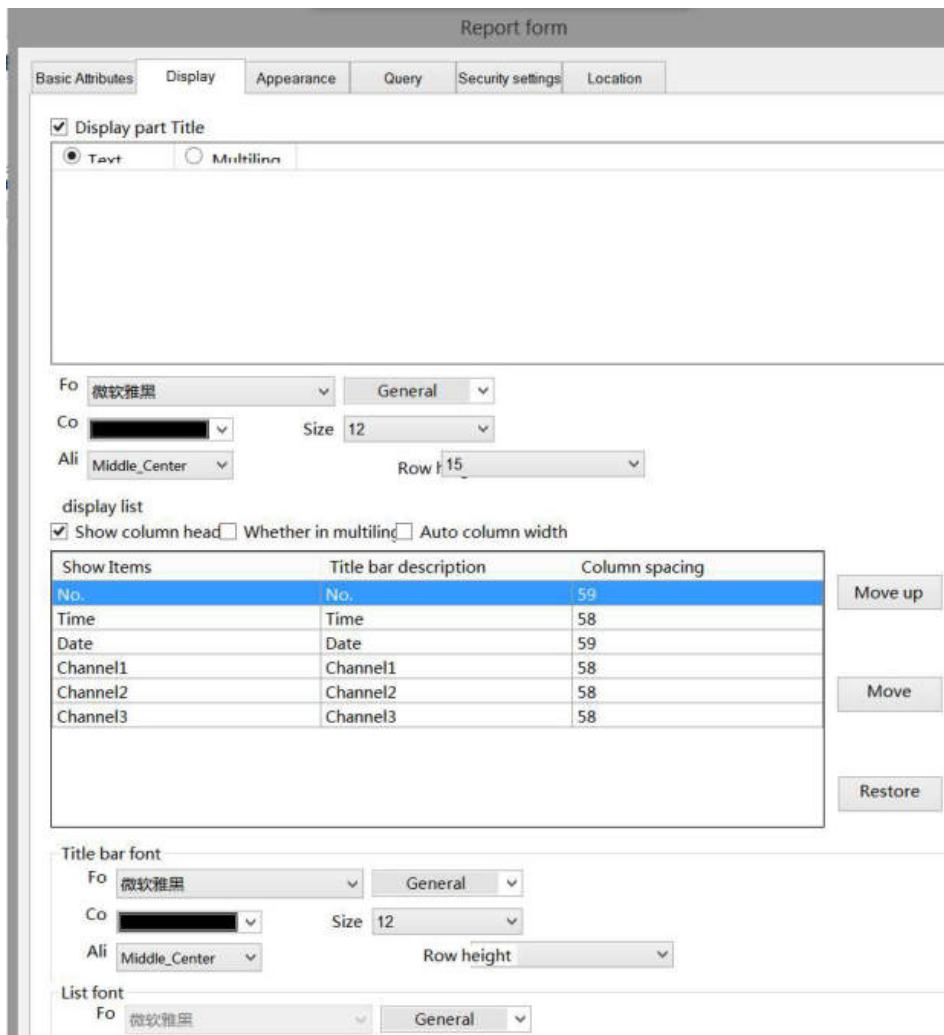

display part title	Set the title of the control is displayed in the first row of the table or can be set to multiple languages (refer to 5-1 for details of multiple languages).	
font	Set the font for component titles.	
size	Set the size of the component title text.	
color	Set the color of component title text.	
display list	show column head	After checking, the title of each column can be displayed.
	whether in multiling	When checked, multiple languages will be used for the title line.
	auto column width	After checking, the table will automatically adjust the column width based on the content of each column.

title bar font		Set the font, size, and color of the title bar.
list font		Set the font, size, and color of text in the list except for the title.
list sequence	chronological order	According to the order of collection time, the first collected information is displayed below the table, and the later collected information is displayed above the table, that is, the latest collection information is displayed at the bottom.
	Time reversal	According to the reverse order of collection time, the first collected information is displayed on the top of the table, and the second collected information is displayed below the table, that is, the latest collection information is displayed at the top.

■ Appearance

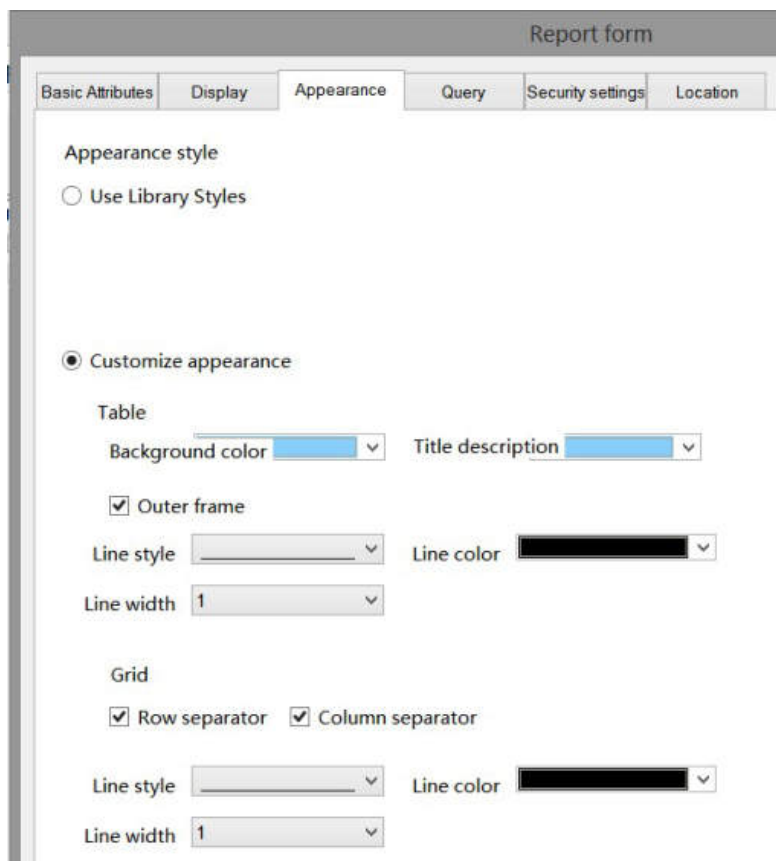

use library style		Select a table style from the gallery.
style selection		Click to select the desired style appearance from the gallery.
style color		Modify the appearance color.
customize appearance		Set your own appearance style.
table	background color	Set the overall background color of the table.
	title background color	Set the background color of the title row.
	outer frame	After checking, display the peripheral border.
	line style	Set the form of box and line, you can choose lines, dotted lines, dashed lines, etc.
	line color	Set the color of the border lines.
	line width	Set the width of the line.
grid	grid	Set the display style of the grid.
	row separator	When checked, a horizontal border will be displayed.
	column separator	When checked, a vertical border will be displayed.

line style	Set the form of box and line, you can choose lines, dotted lines, dashed lines, etc.
line color	Set the color of the border lines.
line width	Set the width of the line.

■ Query

① Export

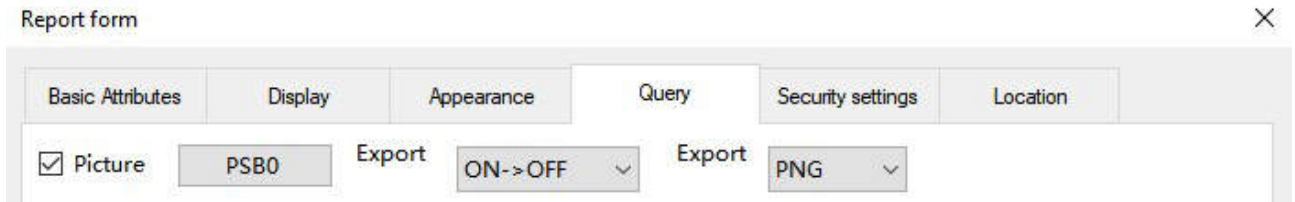

Select the Picture to use export picture function. Meets export conditions, export format is PNG.

② Query

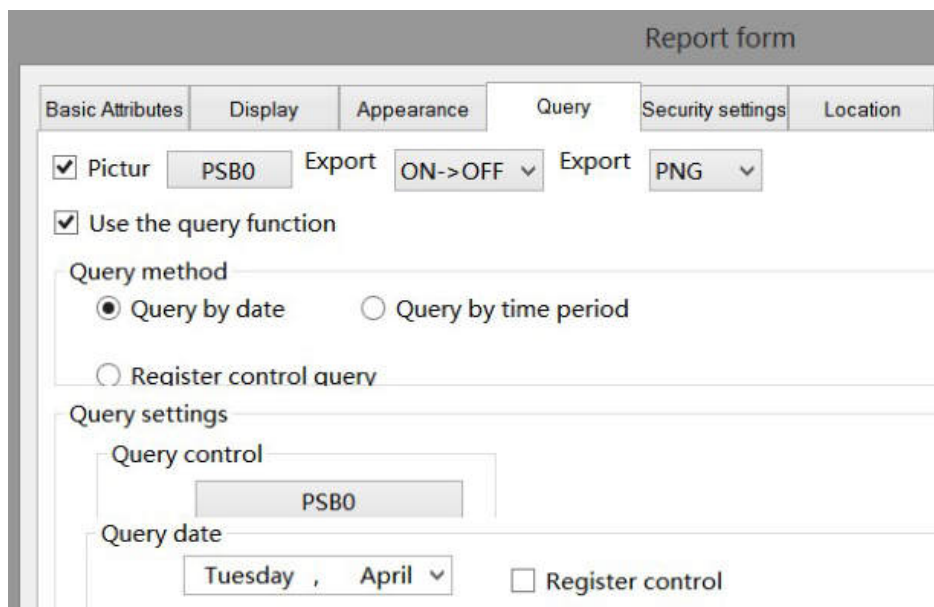

After checking, you can use the query function to filter data based on conditions and display it in a table.

There are two ways to query: by date, by time period, or by register control.

(1) Query by Date: Enter the date you want to query, and after the query control bit is connected, the filtered results will be automatically displayed.

You can also choose "register control" to dynamically set the query address. As shown in the following figure, setting a first address, such as PSW0, will occupy a total of three addresses from PSW0 to PSW2. PSW0 represents year, PSW1 represents month, and PSW2 represents day, all of which are single word unsigned numbers. For example, PSW=2021, PSW2=5, and PSW3=29, the data collection record information on May 29, 2021 will be queried.

Query date

Tuesday , April Register control PSW0

PSW0 : 年(无符号数方式输入, YYYY格式, 例如2004)

PSW1 : Month (input in unsigned number format, MM for)

PSW2 : Day (input in the form of unsigned number in DD f

- (2) Query by time period: Enter the start and end times to query, and after the query trigger bit is connected, the filtered results will be automatically displayed.

Report form

Basic Attributes Display Appearance Query Security settings Location

Picture PSB0 Export ON->OFF Export PNG

Use the query function

Query method

Query by date Query by time period

Register control query

Query settings

Query control

PSB0

Query time period

From Tuesday , April 15 Ho 38 Minute Second

To Tuesday , April 14 Ho 18 Min 1 Second

Register control

Similarly, register control can also be used. After setting the first address, 12 register addresses, including the first address, will be occupied. The first 6 addresses represent the year, month, day, hour, minute, and second of the start time, and the last 6 addresses represent the year, month, day, hour, minute, and second of the end time. The format is consistent with manual settings.

Query time period

From Tuesday , April 15 Ho 38 Minute Second

To Tuesday , April 14 Ho 18 Min 1 Second

Register control PSW0

PSW0 ~ PSW5 Represent start time Year/Month/Day

PSW6 ~ PSW11 Represent end time Year/Month,

- (3) Register controlled query method: Determine the query method based on different register values. When the value is 0, query by date; when the register value is 1, query by time period.

Report form

Basic Attributes Display Appearance Query Security settings Location

Pictur PSB0 Export ON->OFF Export PNG

Use the query function

Query method

Query by date Query by time period

Reaister control quer PSW0 Reaister value 0: bv date space 1: bv time period

Query settings

Query control

PSB0

Query register

PSW0

Example: PSW0~PSW11: According to different query methods, it can take up to 12 words

■ Security setting

Report form

Basic Attributes Display Appearance Query Security settings Location

Display control

Enable

When 隐藏

Devic 本地设备 Settin

Addre PSB 0

Enable Sta ON Indirect

User permission

Hide this component when the user has no permission scope

User permission range Permission1

Same to chapter 4-1-1 straight line security setting part.

■ Location

Same to chapter 4-1-1 straight line location part.

4-5-6. Pie chart

Proportion of data displayed in block format

Example: If the first address is a and the number is set to n, then the addresses displayed for each section are a, a+1, a+2... a+(n-1). The proportion of each sector is the current sector's value/the sum of the values of each sector.



1. Click the "Parts/Data Processing/Pie Chart" in menu bar or the "  " pie chart icon in the device bar of the control window, move the cursor to the screen, click the left mouse button to place, click the right mouse button or use the ESC key to cancel the placement. Modify the length and width of the border through the boundary point.
2. When setting attributes, you can set them in the attribute box that pops up when placing components. You can also double-click on the "pie chart" or select the "pie chart" and right-click to select "attributes" for attribute settings.

■ Basic attributes

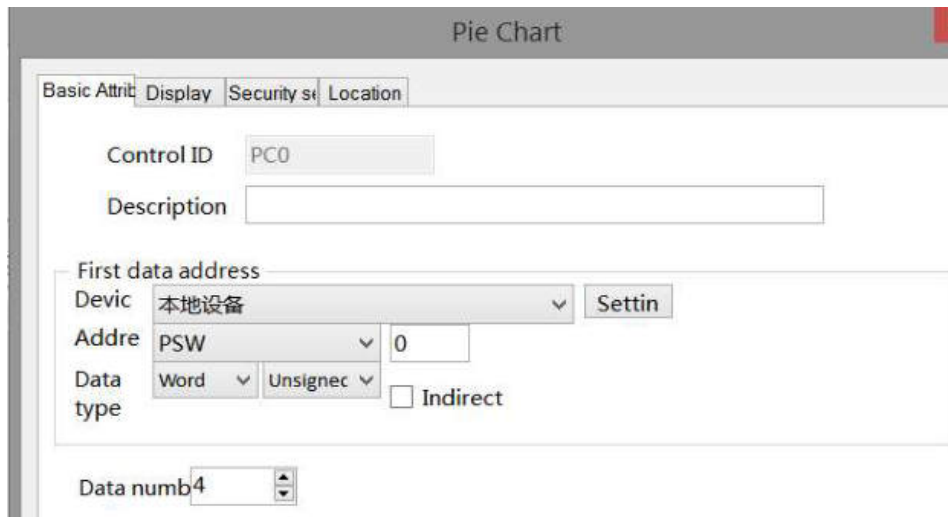

control ID	Used for system management controls, user cannot operate
description	Can be used to annotate the purpose of this control
first data address	Set the first address for displaying section data
device	The device port currently communicating with
address	Set target register number
data type	Byte-8Bit; Word-16Bit; DWord- 32Bit; DDWord -64Bit; BCD format; Hex; Signed number; Unigned number; Floating number
setting	Click "Settings" to enter the address setting interface. This interface allows you to set the use of system registers and user-defined labels. You can click on the address label library or the project tree - library - address label library below to set the labels used (refer to 5-2 Address Label Library for the use of address label library and user-defined labels)

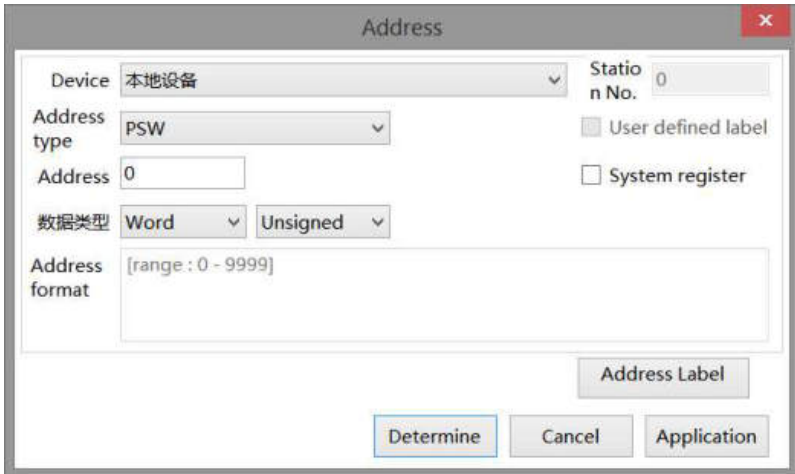
	
indirect specify	<p>Set the current address offset, where the current register address changes with the indirectly specified register value, i.e. $Dx[Dy]=D[x+Dy \text{ numerical value}]$ (x, y=0, 1, 2, 3...). Example: The current register address is PSW0, if the indirectly specified address is PSW100; When the value of the PSW100 register is 0, the register that controls this component remains PSW0; When the value of the PSW100 register is 1, the register that controls this component is PSW1 (and so on)</p>
data number	<p>Set the number of blocks (consecutive addresses after the first address)</p>

■ Display

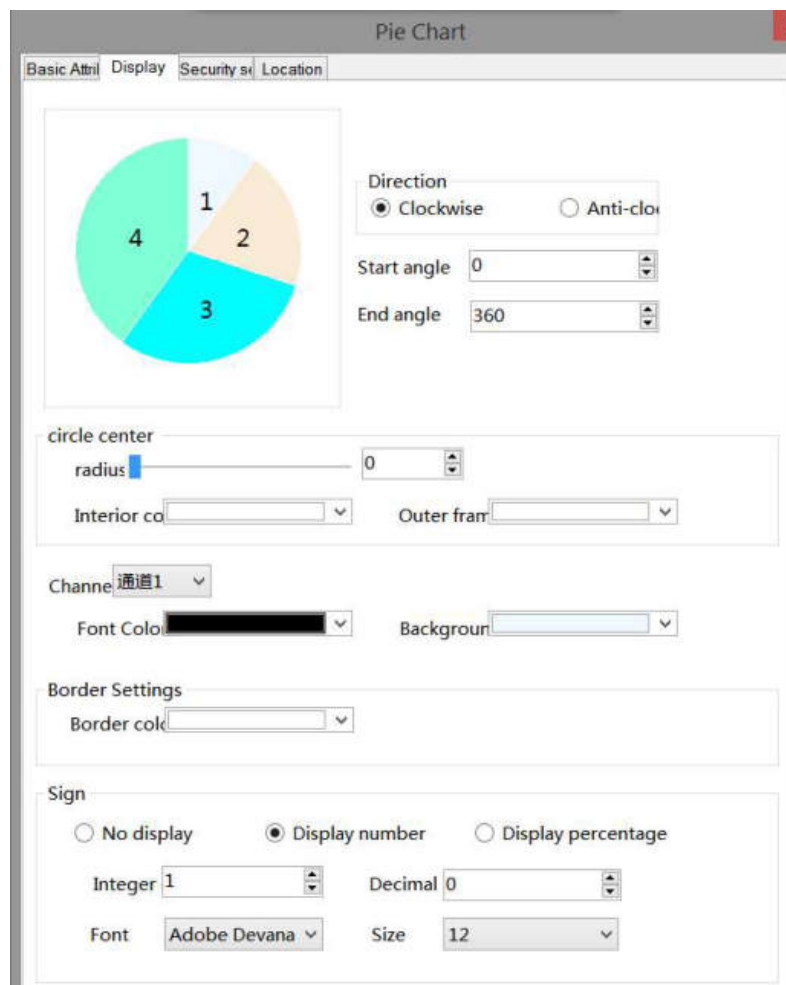

direction	Set the display direction of the address in the section, clockwise or counterclockwise
-----------	--

clockwise		Arrange the display in the order of clock rotation
counterclockwise		Display in reverse order of clock rotation
start angle		Set the starting angle for the pie chart display, with a default of 0 degrees and a clock direction of 12 o'clock (0 o'clock)
end angle		Set the ending angle for the pie chart display, default to 360 degrees, clock 12 o'clock (0 o'clock) direction, default to full circle display
circle center	circle center	Set center size
	radius	Set the radius of the circle, which can be set through the scroll bar or by entering a number
	interior color	Set the display color inside the center of the circle
	outer frame color	Set the display color of the center outline
channel	channel	Select each channel and set the font and background color for each channel
	font color	Set the font color of the selected channel
	background color	Set the background color of the selected channel
border settings	border color	Set the color of the pie chart border
sign	sign	Set the data style displayed on the section, which can be displayed as a percentage, numerical value, or not displayed
	decimal	Set the decimal places for displaying numbers or percentages, which cannot be set when the marker is selected not to be displayed
	font	Set the displayed data font, which cannot be set when the tag is selected not to be displayed
	size	Set the text size for displaying data

■ Security setting

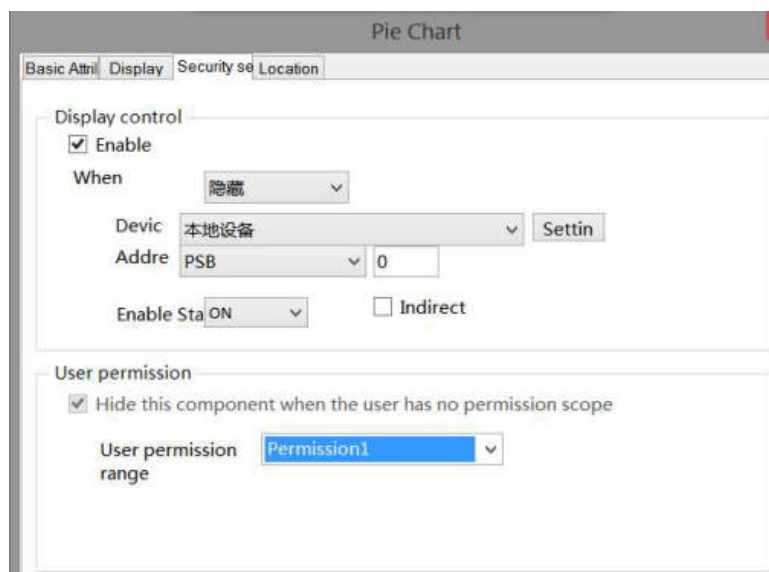

Same to chapter 4-1-1 straight line security setting part.

■ Location

Same to chapter 4-1-1 straight line location part.

4-5-7. Data table



1. Click the "0101" table icon in the control window or Parts/Data Processing/Data Tables in the menu, move the cursor to the screen, click the left mouse button to place, click the right mouse button, or use the ESC key to cancel the placement. Modify the length and width of the border through the boundary point.
2. When setting attributes, you can set them in the attribute box that pops up when placing components, or double-click the drawn "Data Table" or select "Data Table" and right-click to select "attributes" for attribute settings.

■ Basic attributes

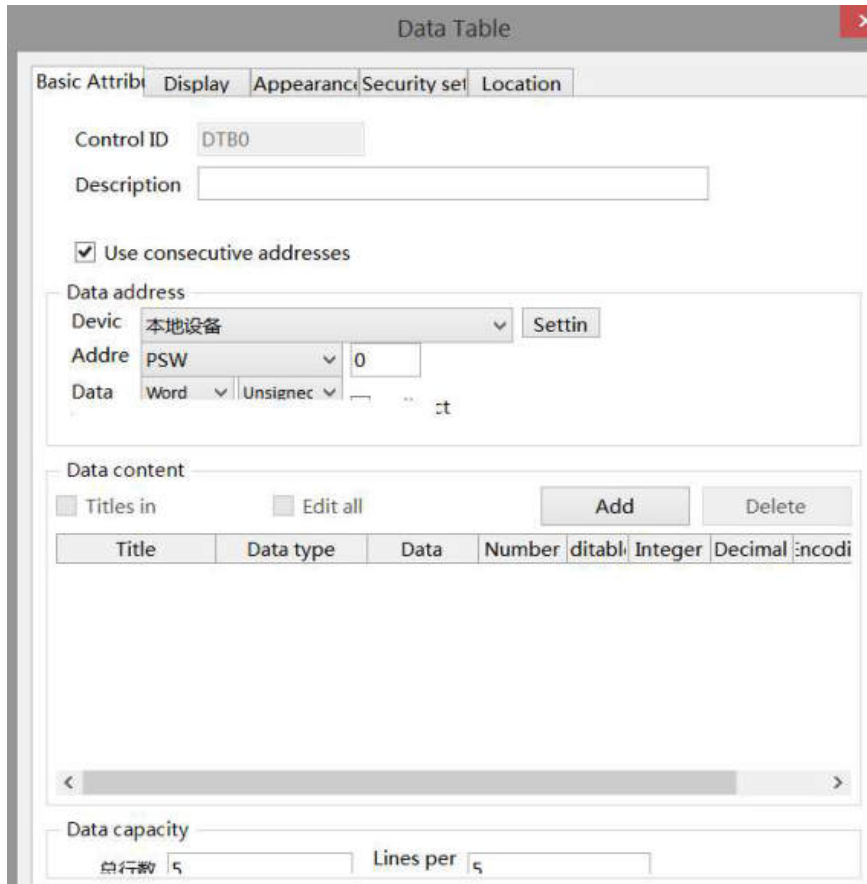

control ID	Used for system management controls, user cannot operate
description	Can be used to annotate the purpose of this control
use consecutive addresses	When checked, the address order will be automatically calculated based on the first address (please refer to the notes below for the use of consecutive addresses without checking)
data address	Set the first address of the data (only appears when continuous addresses are checked)
data content	Set the data title, data type, and data format to be displayed in the table
add/delete	add or delete the data
edit all	After checking, all the data items to be edited can be checked with one click, and the data can be modified in the data table
titles in multi-language	When checked, the title can be in multiple languages. After checking, the title name of each column can be set to display in multiple languages. Click "0101" to enter the multilingual settings (refer to 5-1 label multilingual for specific usage)

	<p>Data content</p> <p><input checked="" type="checkbox"/> Titles in <input checked="" type="checkbox"/> Edit all Add Delete</p> <table border="1"> <thead> <tr> <th>Title</th> <th>Data type</th> <th>Data</th> <th>Number</th> <th>ditabl</th> <th>Integer</th> <th>Decimal</th> <th>:ncodi</th> </tr> </thead> <tbody> <tr> <td><input type="text"/></td> <td>Word</td> <td>Unsiq...</td> <td>1</td> <td><input checked="" type="checkbox"/></td> <td>4</td> <td>0</td> <td>-</td> </tr> <tr> <td></td> <td>Word</td> <td>Unsiq...</td> <td>1</td> <td><input checked="" type="checkbox"/></td> <td>4</td> <td>0</td> <td>-</td> </tr> <tr> <td></td> <td>Word</td> <td>Unsiq...</td> <td>1</td> <td><input checked="" type="checkbox"/></td> <td>4</td> <td>0</td> <td>-</td> </tr> </tbody> </table>	Title	Data type	Data	Number	ditabl	Integer	Decimal	:ncodi	<input type="text"/>	Word	Unsiq...	1	<input checked="" type="checkbox"/>	4	0	-		Word	Unsiq...	1	<input checked="" type="checkbox"/>	4	0	-		Word	Unsiq...	1	<input checked="" type="checkbox"/>	4	0	-
Title	Data type	Data	Number	ditabl	Integer	Decimal	:ncodi																										
<input type="text"/>	Word	Unsiq...	1	<input checked="" type="checkbox"/>	4	0	-																										
	Word	Unsiq...	1	<input checked="" type="checkbox"/>	4	0	-																										
	Word	Unsiq...	1	<input checked="" type="checkbox"/>	4	0	-																										
data setting	After selection, you can set the integer digits, decimal places, leading 0, and column width of the data column for the data																																
data capacity	Set the total number of rows and rows per page displayed in the data table																																



- (1) When the title is checked to display multiple languages, " " will be displayed in the title description. Clicking on it will lead to the multi language library setting interface for setting multiple languages.

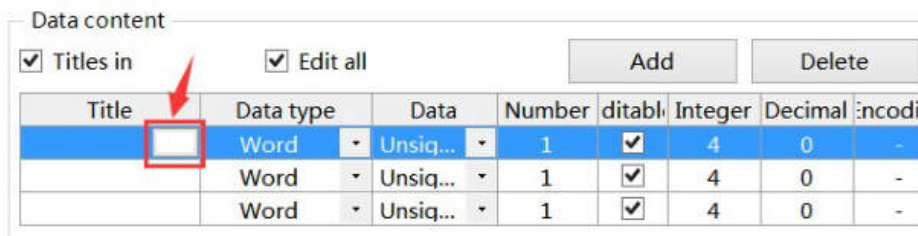

- (2) When continuous addresses are not used, the display is shown in the following figure:

Use consecutive addresses

Data capacity

行數 Number

The way to set data is as follows:

- ① Place the mouse over the table, and when the mouse changes from an arrow to a hand shape, click on a cell in the table to set the address

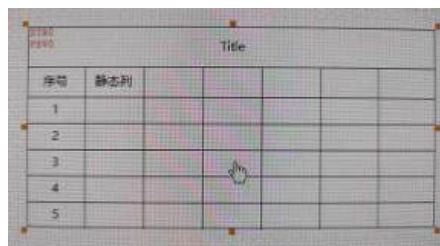

- ② Set the address

Fill type: address monitoring, monitoring numerical values and characters.

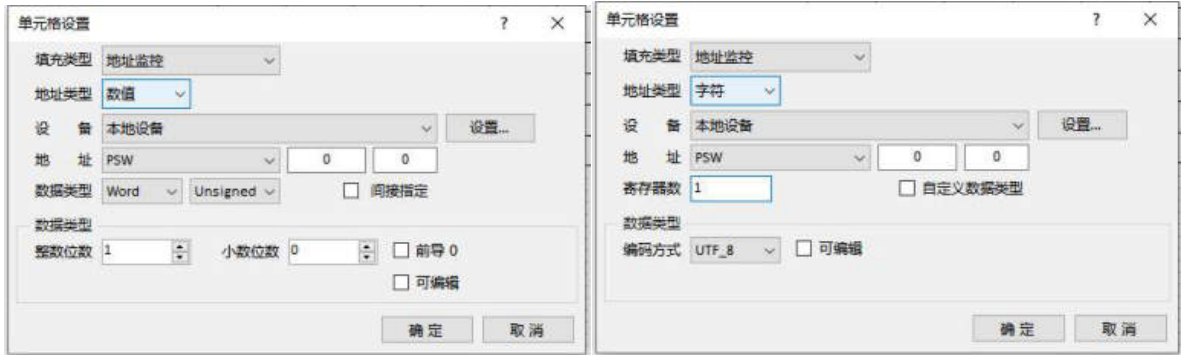

Fill type: text monitoring

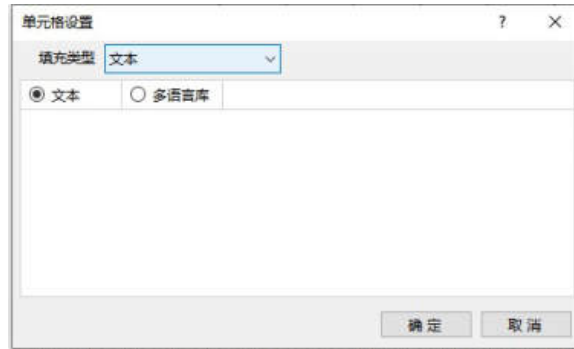

Set the description of three controls including data input, character input, and Chinese input.

(3) When the data type is string, characters or Chinese can be displayed.

To display characters, the encoding format must be set to ASCII, UTF_8 or UTF_16.

To display Chinese, the encoding format needs to be set to GB2312.

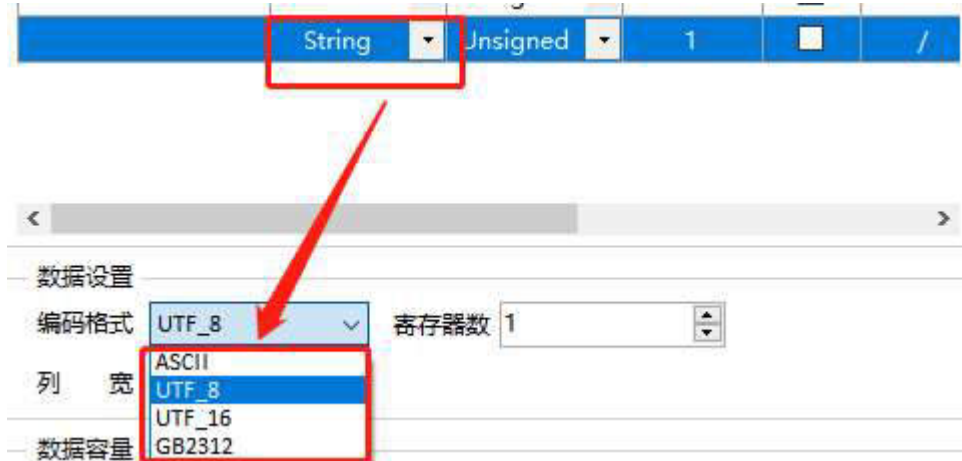

■ Display

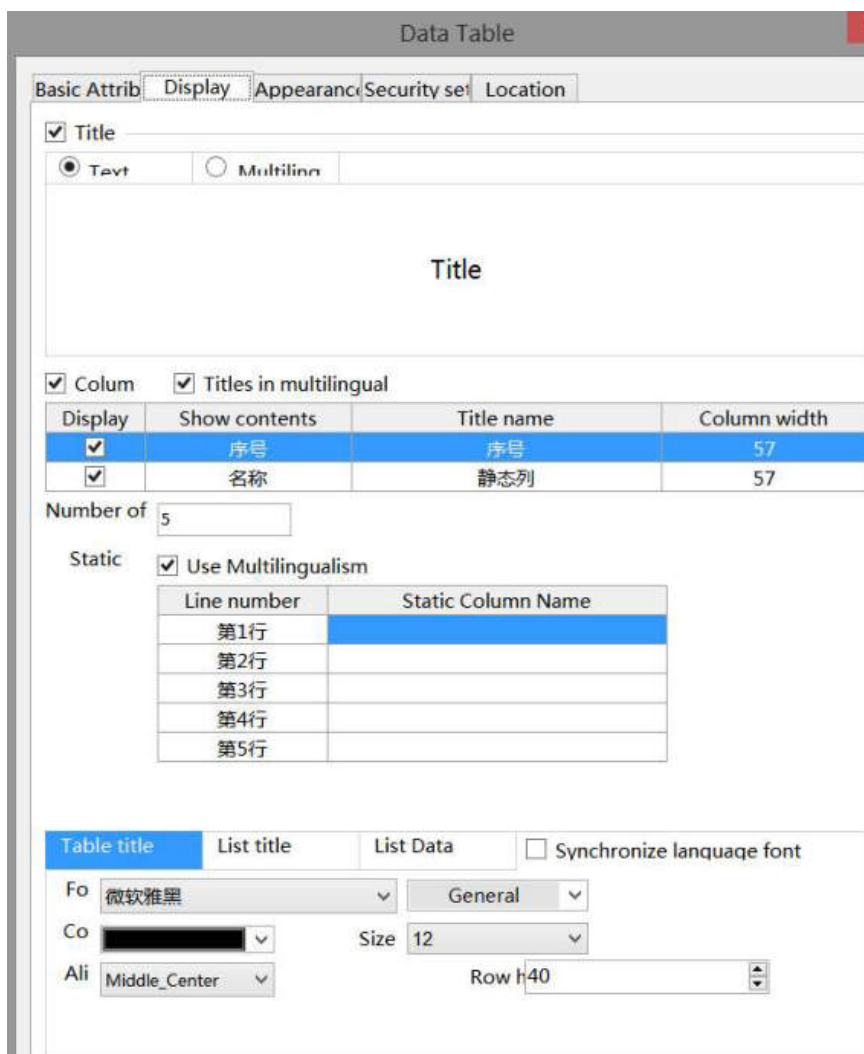

title	text	Set the name of the data table header
	multiling	After checking, the header content can be set to multiple languages
column		Show column titles after checking
titles in multilingual		After checking, the title of each column can be set to display in multiple languages
display number		After checking, an automatically incremented sequence number column will be displayed in the first column of the table
display name		After checking, the custom name of each row will be displayed, which can be edited in the static column name table below, or whether to use multiple languages can be set
table/list title		Set the font, color, size, alignment, and line height for the title display
list data		Set the color, size, alignment, and row height of the data style font
synchronize language font		You can check to use the same font. After checking, the color, size, alignment, and line height of the three fonts remain consistent

■ Appearance

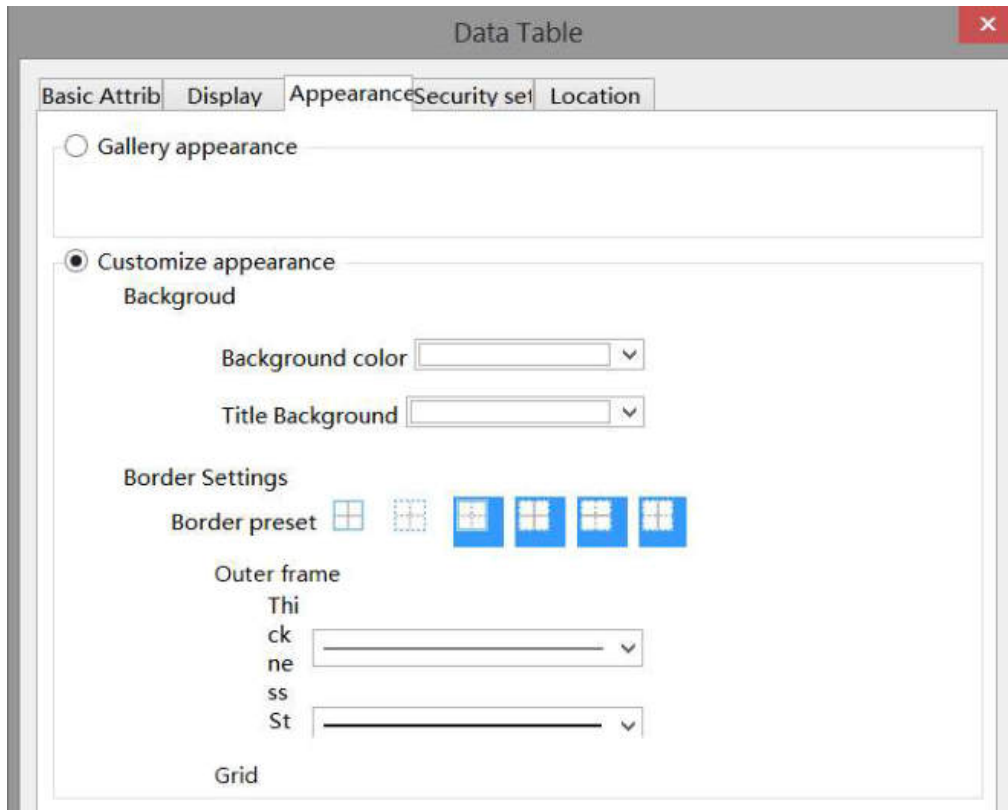

gallery appearance	style selection	Click and select a table style from the gallery <input checked="" type="radio"/> Gallery appearance <input type="button" value="Style selection"/>	
customize appearance	background	background color	Set Table Background Color
		title color	set title background color
	border settings	border preset	Select a border style based on the preview image
		outer frame	Choose border thickness, style, and color
		grid	Choose the thickness, style, and color of the grid

■ Security setting

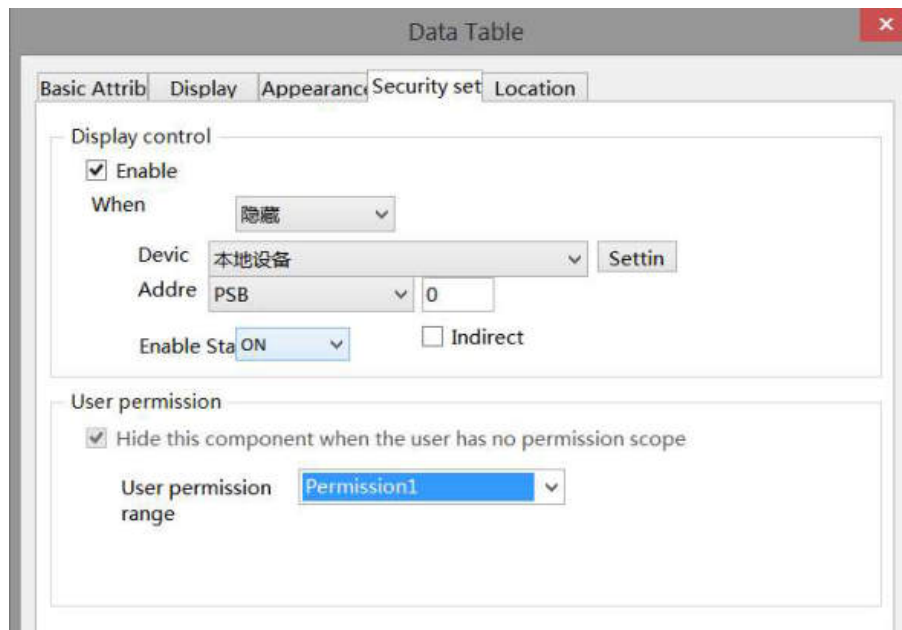

display control	Use bit control to display the component, and hide the control when the condition is not met
enable	When checked, display control will be enabled
When validation fails	Set the display of the control when validation fails
address	Set the target coil for positioning control
enable state	Set the ON state to be valid or the OFF state to be valid; Example: If the device is checked as shown in the above figure, the bit control is PSB0, and if verification fails, it is hidden. If the enabled state is ON, the component is displayed normally when PSB0 is ON, and if PSB0 is OFF, the component is hidden and not displayed.
user permission	Set controlled permission levels. After setting the required user's permission range, the following three functions can be checked as needed: (1) After the operation is completed, the usage permission will be cancelled: if this option is not checked, the corresponding level password needs to be entered every time the component is operated. After checking, only one entry is required. (2) When the user has no permission range, a prompt window will pop up. (3) When the user does not have permission range, hide the component.



Please refer to chapter 4-2-3 value input for permission function.

■ Location

Same to chapter 4-1-1 straight line location part.

4-6. Recipe

4-6-1. Recipe edit

click “parts/recipe/recipe edit in the menu or click recipe edit icon in tool bar to enter recipe edit interface.

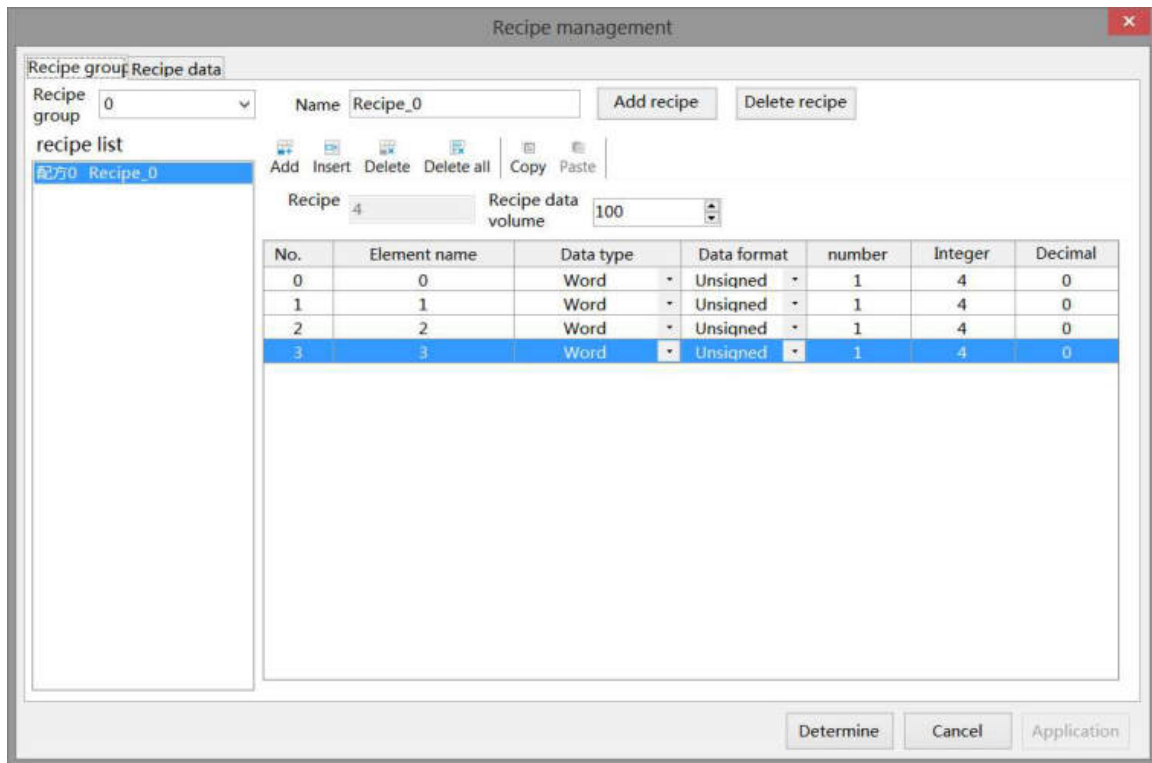

■ Recipe group

recipe group	Select the recipe group that needs to be edited, and all added recipe groups can be selected through the drop-down menu																
name	Set the name of the recipe group																
add recipe	After entering the name, click on "Add Recipe" to add a new recipe group																
delete recipe	Click to delete the selected recipe group																
recipe group list	Display all added recipe group numbers and names in the list below																
add	Add recipe elements																
insert	Insert a new recipe element below the selected recipe element																
delete	Delete selected recipe elements																
delete all	Delete all elements in this group																
copy	Copy the selected recipe element																
paste	Pasting the copied data at the selected location, a new piece of data named xxxx_copied will be added																
	<table border="1"> <thead> <tr> <th>No.</th> <th>Element name</th> <th>Data type</th> <th>Data format</th> </tr> </thead> <tbody> <tr> <td>0</td> <td>0</td> <td>Word</td> <td>Unsigned</td> </tr> <tr> <td>1</td> <td>1</td> <td>Word</td> <td>Unsigned</td> </tr> <tr> <td>2</td> <td>1_Copied</td> <td>Word</td> <td>Unsigned</td> </tr> </tbody> </table>	No.	Element name	Data type	Data format	0	0	Word	Unsigned	1	1	Word	Unsigned	2	1_Copied	Word	Unsigned
No.	Element name	Data type	Data format														
0	0	Word	Unsigned														
1	1	Word	Unsigned														
2	1_Copied	Word	Unsigned														
recipe length	Automatically display the length of the currently added recipe and cannot be edited																
recipe volume	Each group of recipe data has a separate data volume. As shown in the above figure, if the data amount is set to 100, it means that up to 100 sets (0-99) of data can be set within the																

recipe group 0. If it exceeds this, a pop-up prompt will appear in the following figure.

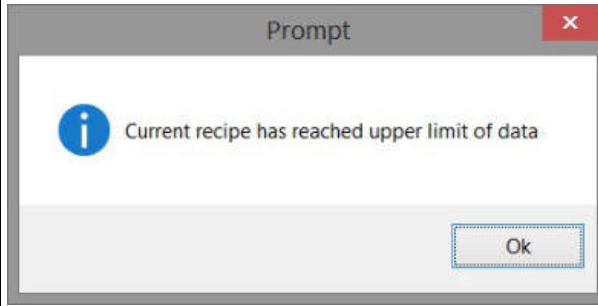

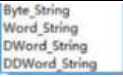
recipe element	element list	Show all added elements
	No.	Recipe element number, cannot be modified
	element name	Set element names, such as water, length, etc
	data type	Set the recipe element data type, which can be selected from 8-bit, 16-bit, 32-bit, or 64-bit types
	data format	Set the data format for recipe elements
	number	only when selecting  , the numbers can be set. Byte_String-1 character Word_String-2 characters DWord_String-4 characters DDWord_String-8 characters
	words	Display the address length occupied by this element, with 16 bits being 1, 32 bits being 2, and 64 bits being 4
	integer	Set the integer digits of data
decimal	Set the number of decimal places for data	

■ Recipe data

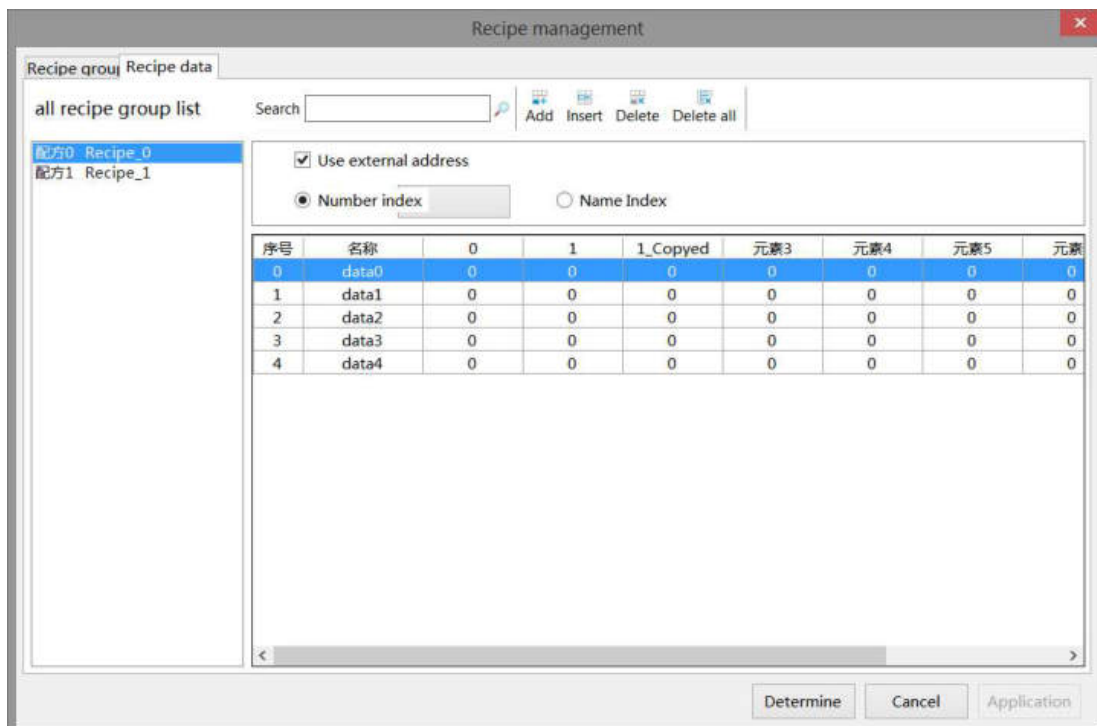

search	Enter a name to search for recipe data
add	Add recipe data below the selected location
insert	Insert a new piece of data at the selected data
delete	Delete selected recipe data
delete all	Delete all recipe data for this group
use external address	Recipe index function, which can be indexed by recipe number or name

4-6-2. Recipe table

Used to display the recipe data set in recipe edit, which can be edited in this table.

1. Click "Parts/Recipe/Recipe Table" icon in the menu bar or " " icon in the device bar of the control window, move the cursor to the screen, click the left mouse button to place, click the right mouse button, or use the ESC key to cancel the placement. Modify the length and width of the border through the boundary point.
2. When setting attributes, you can set them in the attribute box that pops up when placing components. You can also double-click on the "Recipe Table" or select "Recipe Table" and right-click to select "attributes" for attribute settings.

■ Basic attributes

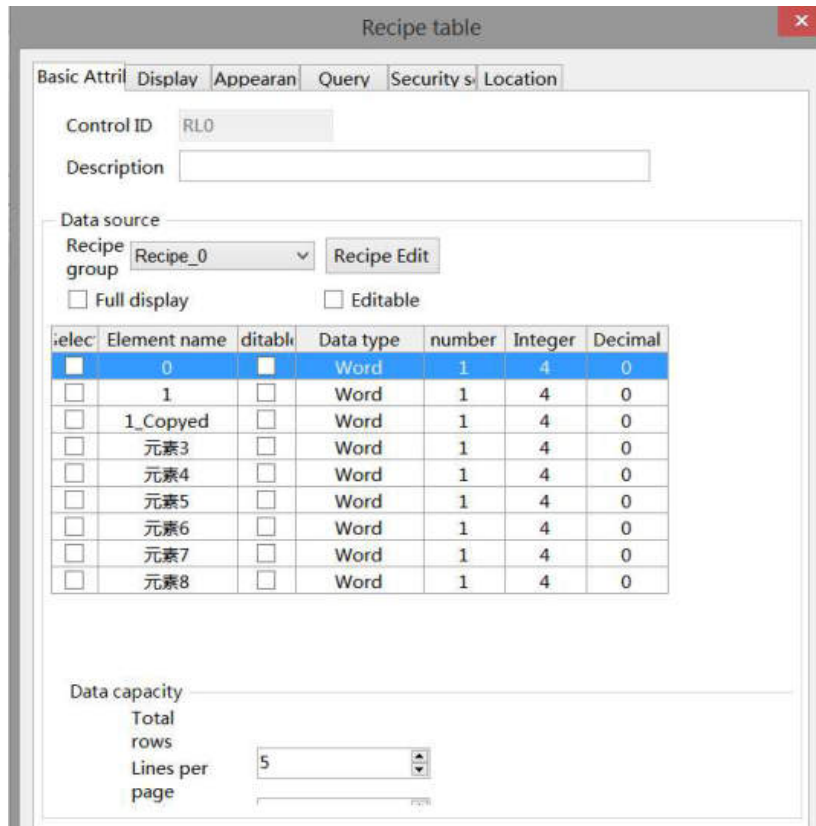

control ID	Used for system management controls, user cannot operate
description	Can be used to annotate the purpose of this control
data source	recipe group
	Select the recipe group that needs to be displayed, or click on the recipe editor to add or modify the recipe group
	When the recipe group is selected, the table below displays all the elements of the selected recipe group

full display	After checking, all the recipe items to be displayed can be checked with one click. Only when checked under the "Selection" column will the data of each group of the element be displayed. If you do not want to display the data of a certain element, simply uncheck it	
editable	After checking, all the recipe items to be edited can be checked with one click, and the data can be modified in the recipe table. Only after checking the "Editable" column and downloading it to the screen or simulating it can the data of a certain element be edited. If a certain element is not checked, it cannot be modified	
data capacity	total rows	Set the maximum number of rows displayed in the table
	lines per page	Set the number of rows displayed on each page to be less than or equal to the maximum number of rows per page

■ Display

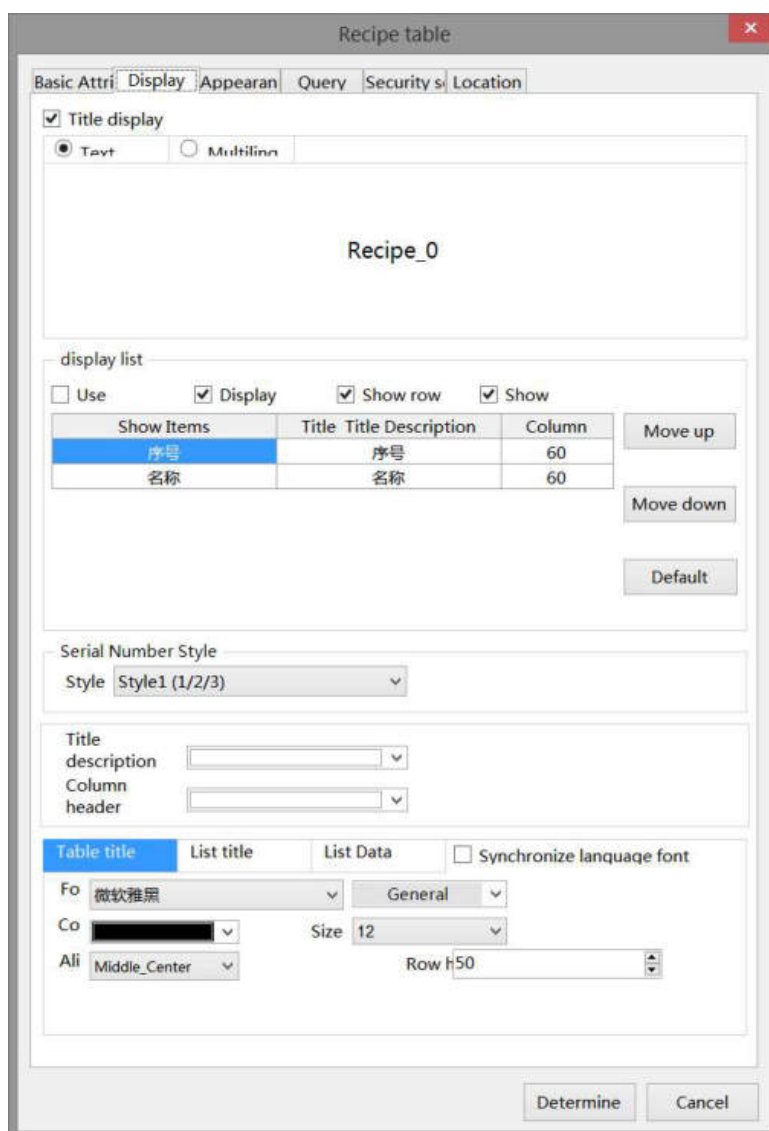

title display	title display	To display the title, you need to check the title display option before you can set the relevant settings for the title
	text	Set the name of the recipe table header
	multiling	After checking, the header content can be set to multiple languages
display list	use	After checking, the title of each column can be set to display in multiple languages

	multilanguage	
	display no.	After checking, an automatically incremented sequence number column will be displayed in the first column of the table
	show row title	After checking, the column titles and element names for each row will be displayed, and you can also edit the title names in the table below
	show column title	After checking, the column title (i.e. element name) of the list name will be displayed, or you can edit the title name in the table below
	operations	After selecting a row in the table, you can click "Move Up" or "Move Down" to move the selected row up or down. You can click on the default and restore the default settings with one click



When the list displays multiple languages, "..." will be displayed in the bottom right corner of the title description. Clicking on it will lead to the multi language library setting interface to set up multiple languages.



serial number style	Set the style of the sequence number column, 1/2/3 or the group1/group2/group3
title background color	Set the background color of the title
column title background color	Set the background color of column title
font	Set the font, color, size, alignment, and row height for table titles/list titles/list data. You can check to use the same font. After checking, the three fonts, color, size, alignment, and row height, all remain consistent.

■ Appearance

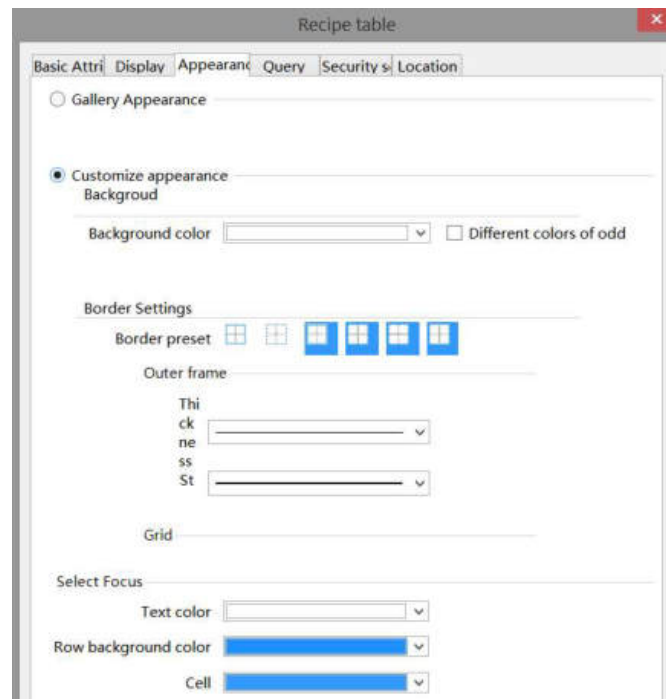

gallery appearance	style selection		Click and select a table style from the gallery <input checked="" type="radio"/> Gallery Appearance <input type="button" value="Style selection"/>
customize appearance background	background setting	background color	set the background color of the table
		different color of odd	After selection, you can set the odd and even rows to display different colors <input checked="" type="radio"/> Customize appearance Background Odd line color <input type="text"/> <input type="button" value="v"/> <input checked="" type="checkbox"/> Different colors of odd Even line color <input type="text"/> <input type="button" value="v"/>
	border setting	border preset	Select a border style based on the preview image
		outer frame	Set the thickness, style, and color of the outer frame
		grid	Set the thickness, style, and color of the grid
	select focus	select focus	Set the display style
		text color	Set the text color displayed
		row background color	Set the selected row background color
cell		Set the background color of the selected cells	

■ Query

① Export

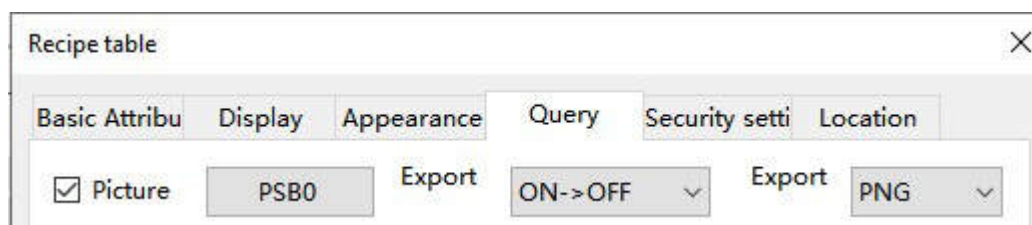

Select the **Picture** to use picture export function. Meets export conditions, export format is PNG.

② Query

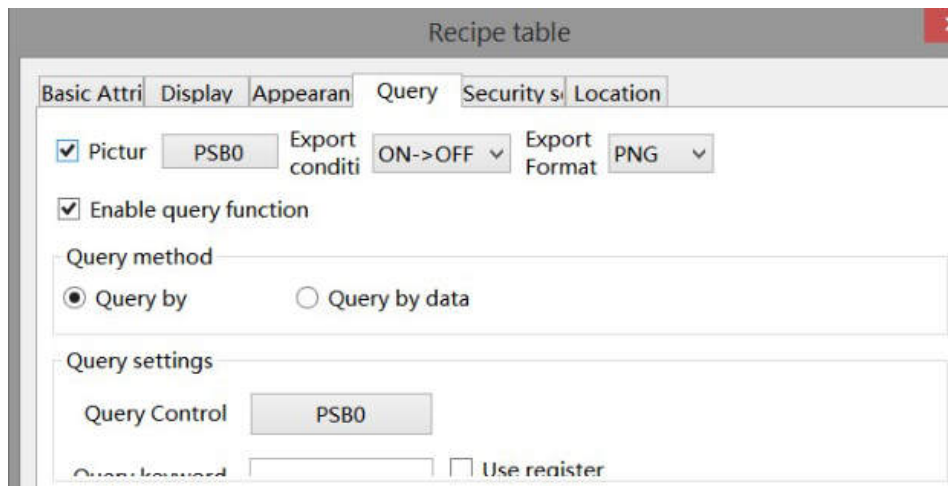

Select **Enable query function** to use query function. Filter data based on conditions and display it in the current recipe table.

There are two ways to query: by keyword and by data, and you can also use register control to query.

- (1) Query by keyword: Enter the keyword to be queried, and after the query control bit is connected, the filtered results will be automatically displayed; You can also choose to use registers to dynamically specify keywords for queries.



- (2) Query by data: Enter the data to be queried, and after the query control bit is turned on, all recipes containing this data will be automatically displayed. Alternatively, you can choose to use registers to dynamically specify the query data.

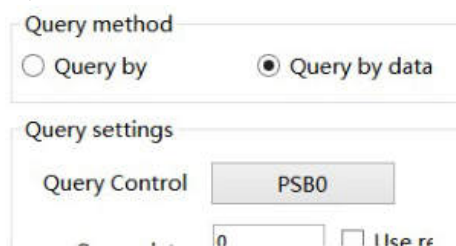

■ Security setting

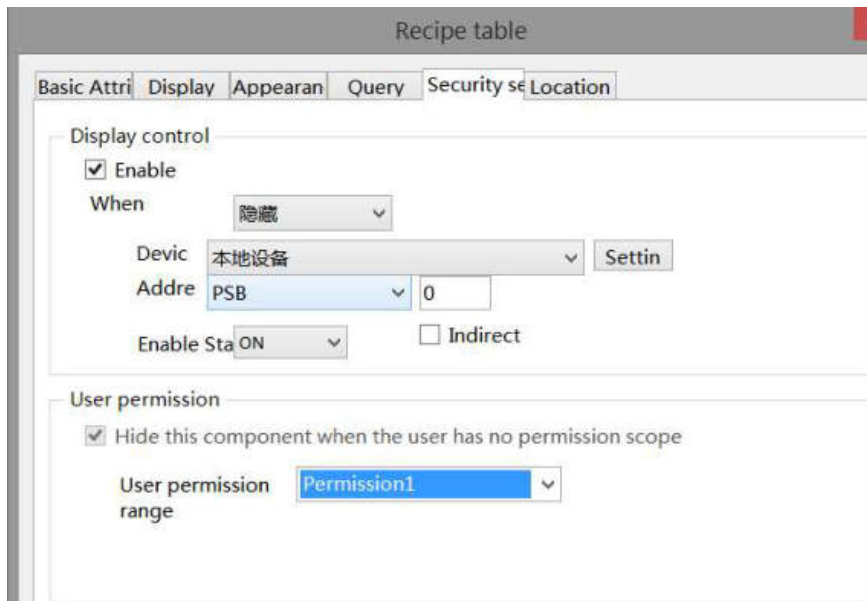

Same to chapter 4-1-1 straight line security setting part.

- Location

Same to chapter 4-1-1 straight line location part.

4-6-3. Recipe transfer

Use this button to upload and download recipes.



1. Click "Parts/Recipe/Recipe Transfer" icon in the menu bar or the "  " icon in the device bar of the control window, move the cursor to the screen, click the left mouse button to place, click the right mouse button, or use the ESC key to cancel the placement. Modify the length and width of the border through the boundary point.
2. When setting attributes, you can set them in the attribute box that pops up when placing components. You can also double-click on "Recipe Transfer" or select "Recipe Transfer" and right-click to select "attributes" for attribute settings.

- Basic attributes

control ID	Used for system management controls, user cannot operate
description	Can be used to annotate the purpose of this control
action	Select the button action mode, and you can choose to transmit when pressed or released
transmission mode	Set the transmission direction of the recipe, which can be downloaded from the HMI to the PLC or uploaded from the PLC to the HMI
download recipe to PLC	Transfer the recipe data in the HMI to the PLC address, which is set in the address below
upload recipe from PLC	Read the data from the PLC address to the HMI and replace the existing recipe data
register control	Using register controlled transmission method, transmitting through rising/falling edge triggering <div style="border: 1px solid gray; padding: 5px; margin-top: 5px;"> <p>transmission mode</p> <p><input type="radio"/> Download recipe to <input type="radio"/> Upload Recipe from PLC</p> <p><input checked="" type="radio"/> Register control <input type="checkbox"/> Download recipe to</p> <p><input type="checkbox"/> Upload Recipe from</p> </div>
recipe source	Select the recipe group that needs to be transferred, or click on the [recipe] button to modify the recipe data
register	After checking this option, the value in the register can be used to control which recipe group to export (if the value in the register is 0, it means that the upload and download data transmission of recipe group 0 is being carried out; if the value in the register is 1, it means that the upload and download data transmission of recipe group 1 is being carried out)
number of words	Display the length of the recipe that needs to be transferred and cannot be changed
PLC address	Set the PLC initial address for transmission or upload, and calculate the occupied

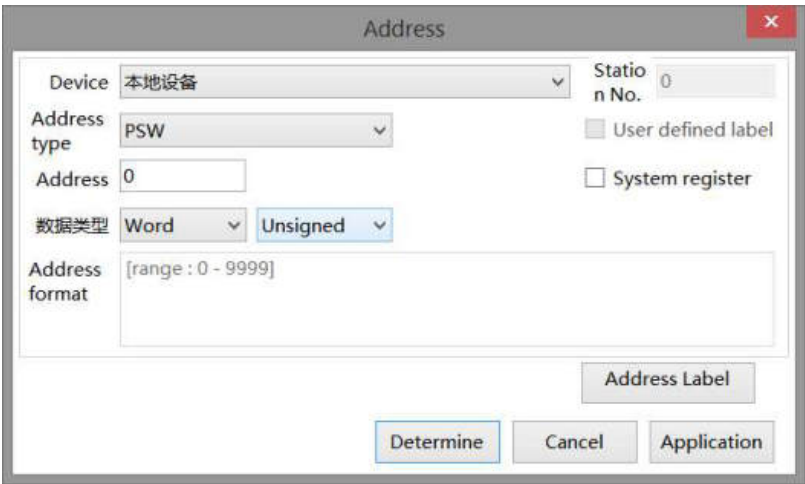
	address length based on the word numbers set above
device	The device port currently communicating with
address	Set Target Register Number
data type	Byte-8Bit; Word-16Bit; DWord- 32Bit; DDWord -64Bit; BCD; Hex; Signed number; Unigned number; Floating number
setting	<p>Click "Settings" to enter the address setting interface. This interface allows you to set the use of system registers and user-defined labels. You can click on the address label library or the project tree - library - address label library below to set the labels used (refer to 5-2 Address Label Library for the use of address label library and user-defined labels)</p> 
indirect specify	Set the current address offset, where the current register address changes with the indirectly specified register value, i.e. $Dx [Dy]=D [x+Dy \text{ numerical value}]$ (x, y=0, 1, 2, 3...). Example: The current register address is PSW0, if the indirectly specified address is PSW100; When the value of the PSW100 register is 0, the register that controls this component remains PSW0; When the value of the PSW100 register is 1, the register that controls this component is PSW1 (and so on)
recipe transfer completion	Set the flag bit for transmission completion, and automatically set it to ON after transmission is completed

■ Appearance

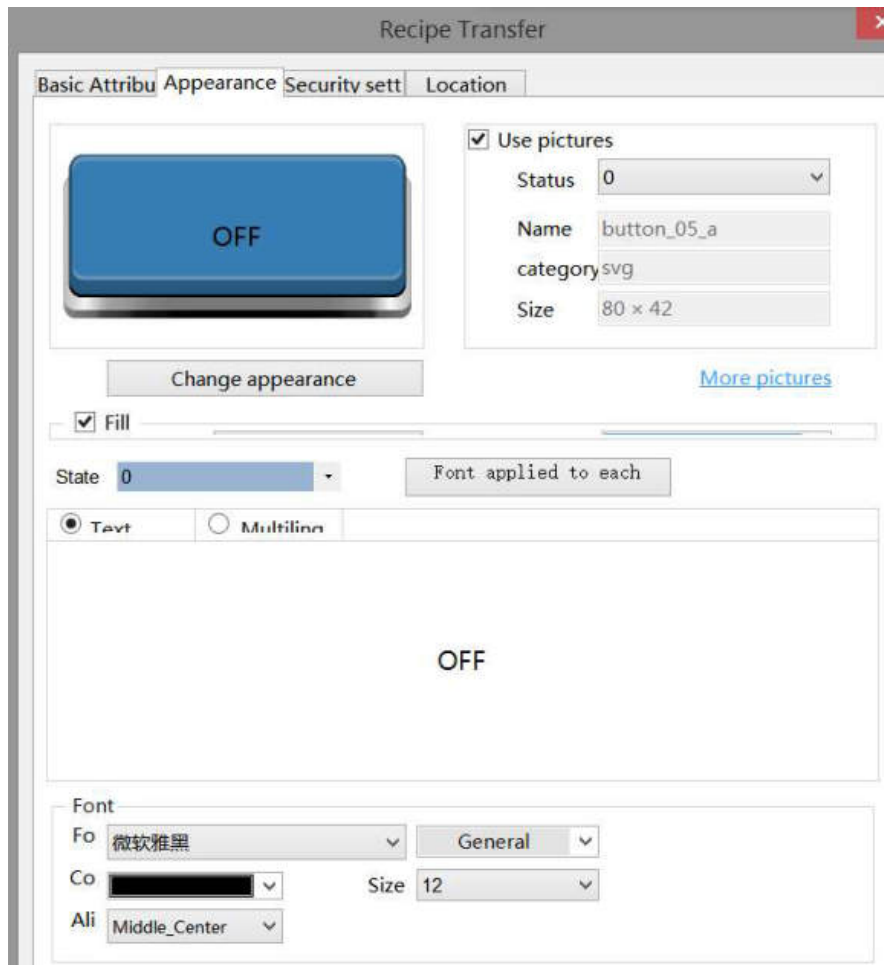

use pictures	You can check whether to use images. If checked, you can set the appearance of the recipe transmission in two states: (0, 1). After selecting the state in the upper right corner, click "Change Appearance" or "More pictures" to select custom images to change the appearance
fill	Can set fill styles (solid/gradient) and fill colors
state	You can set the text prompt content for recipe transmission in two states (0, 1), and whether to use multiple languages (please refer to the description of libraries in chapter 4-7 for specific use of multiple language libraries). Check the drop-down list to set the font corresponding to the corresponding status of the recipe transmission, or click on the "Font applied to each state" button to set the font for all states
font	The font, size, color, and display position of the font in the control can be set

■ Security setting

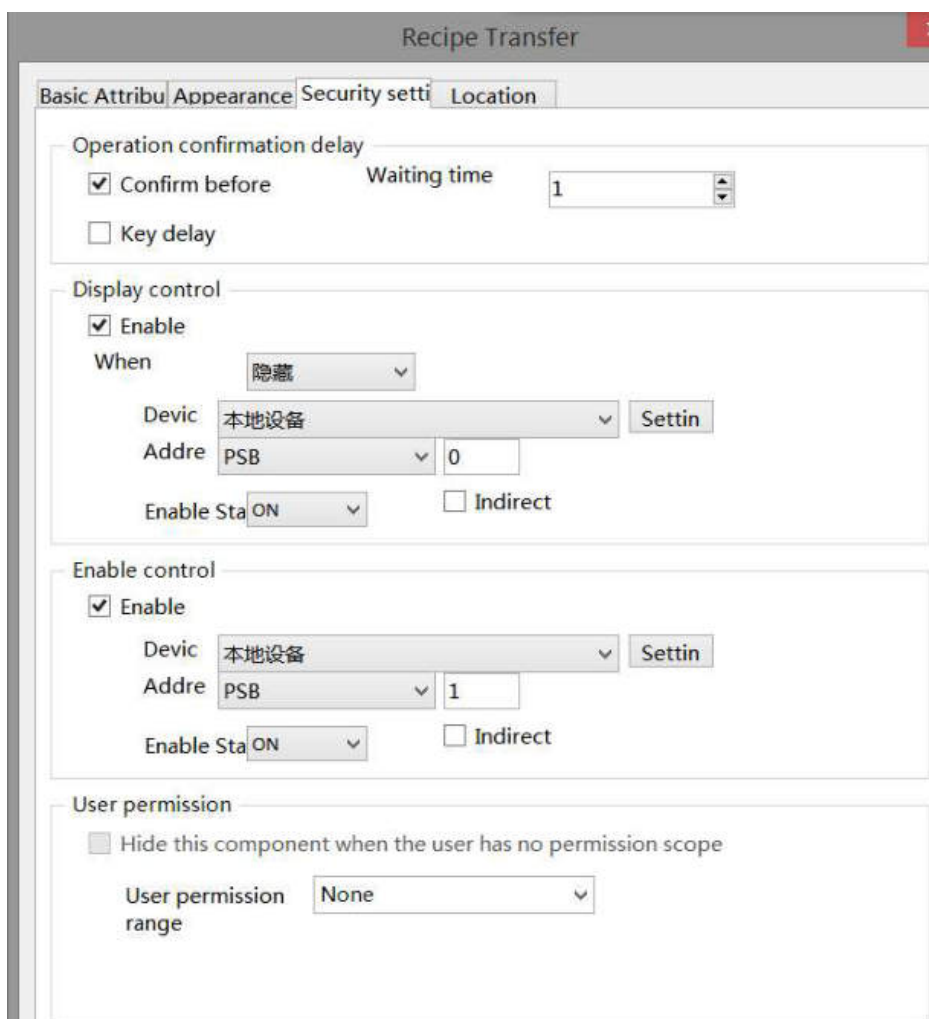

operation confirmation delay	You can set the delay time (s). If this option is checked, a pop-up window will appear when operating the component, saying "Are you sure to execute this operation?" If you do not click "ok" or "cancel" within the set waiting time, the pop-up window will disappear and the operation will fail; If you click 'OK' within the waiting time, the operation is successful, but clicking 'Cancel' is invalid.
key delay	Long press the set delay time before the operation takes effect
display control	Use bit control to display the component. When the conditions are not met, the control is hidden and defaults to hidden, which cannot be modified
enable	When checked, display control will be enabled
When validation fails	Set the display of the control when validation fails
address	set the target coil for bit control
enable state	Set the ON state to be valid or the OFF state to be valid. Example: If the device is checked as shown in the above figure, the bit control is PSB0, and if verification fails, it is hidden. If the enabled state is ON, the component is displayed normally when PSB0 is ON, and if PSB0 is OFF, the component is hidden and not displayed.
enable control	Can be set with bit restrictions (customizable enable control enabled state), and only when the enable conditions are met can the component be used normally (as shown in the figure above: when PSB1 is in the ON state and the trigger conditions are met, this component can be used; if PSB1 is in the OFF state, even if the trigger condition is met, this component is still unavailable)

user permission	<p>Set controlled permission levels.</p> <p>To set the permissions for this component, you need to enter the password for the set permission level before the component can be used normally. When there is no permission for this component, it will be hidden</p>
-----------------	---

■ Location

Same to chapter 4-1-1 straight line location part.

4-6-4. Recipe transfer application

1. Create the recipe data table to be transferred in "Recipe Edit" (for the convenience of explaining the function, the following data is for example)

1> Establish Recipe 0- Bread recipe 0

The screenshot shows the 'Recipe management' interface. The 'Recipe data' tab is active, showing 'Recipe group' set to 0 and 'Name' as 'Bread recipe 0'. Below the recipe list, there are input fields for 'Recipe' (5) and 'Recipe data volume' (100). A table lists ingredients with their data types and formats:

No.	Element name	Data type	Data format	number	Integer	Decimal
0	flour	Word	Unsigned	1	4	0
1	water	Word	Unsigned	1	4	0
2	sugar	Word	Unsigned	1	4	0
3	butter	Word	Unsigned	1	4	0
4	egg	DWord	Float	1	4	0

The screenshot shows the 'all recipe group list' tab. It includes a search bar and a table of recipe data:

序号	名称	flour	water	sugar	butter	egg
0	数据0	10	11	12	13	14.6
1	数据1	20	21	22	23	24.6
2	数据2	30	31	32	33	34.6
3	数据3	40	41	42	43	44.6
4	数据4	50	51	52	53	54.6
5	数据5	60	61	62	63	64.6
6	数据6	70	71	72	73	74.6
7	数据7	80	81	82	83	84.6
8	数据8	90	91	92	93	94.6
9	数据9	100	101	102	103	104.6

2> Build Recipe 1-Bread recipe 1

Recipe management

Recipe group: Recipe data

Recipe group: 1 Name: Bread recipe 1 Add recipe Delete recipe

recipe list

配方0 Bread recipe 0
配方1 Bread recipe 1

Add Insert Delete Delete all Copy Paste

Recipe: 5 Recipe data volume: 100

No.	Element name	Data type	Data format	number	Integer	Decimal
0	flour	Word	Unsigned	1	4	0
1	water	Word	Unsigned	1	4	0
2	sugar	Word	Unsigned	1	4	0
3	butter	Word	Unsigned	1	4	0
4	egg	DWord	Float	1	4	4

Recipe management

Recipe group: Recipe data

all recipe group list Search:

Add Insert Delete Delete all

Use external address

序号	名称	flour	water	sugar	butter	egg
0	数据0	100	101	102	103	104.1044
1	数据1	200	201	202	203	204.2044
2	数据2	300	301	302	303	304.3044
3	数据3	400	401	402	403	404.4044
4	数据4	500	501	502	503	504.5044
5	数据5	600	601	602	603	604.6044
6	数据6	700	701	702	703	704.7044
7	数据7	800	801	802	803	804.8044
8	数据8	900	901	902	903	904.9044
9	数据9	1000	1001	1002	1003	1004.1004

2. Set data transfer function

1> Establish recipe transfer settings (the function of transferring recipe data can be achieved through function keys/recipe transfer).

recipe transfer-download recipe to PLC

Recipe Transfer

Basic Attributes | Appearance | Security settings | Location

Control ID: RT0

Description: [Empty]

Action: Press

transmission mode

Download recipe to Upload Recipe from PLC

Register control

Recipe source: Bread recipe 0 [Recipe] [Register] PFWO

PLC address

Device: 本地设备 [Settin]

Address: PSW 0

Data type: Word Unsignec Indirect

Recipe transfer completion [PSB0]

Function key – recipe download

Function key

Function | Appearance | Security settings | Location

Control ID: FB0

Description: [Empty]

Action: Press Status

Start [Empty]

Functions

Optional functions

- 设置线圈
- 设置数据
- 四则运算
- 数据传输
- 画面切换
- 调用窗口
- 关闭窗口
- 导入CSV
- 导出CSV
- 上传配方
- 下载配方
- 函数调用
- 画面打印

Download recipe

Basic Attributes | Security settings

配方源: Bread recipe 0 [Recipe] [Specified] PFWO

Recipe download address

Device: 本地设备 [Settin]

Address: PSW 0

Data type: Word Unsignec Indirect

Recipe transfer completion flag [PSB0]

[Determine] [Cancel] [Application]

Recipe upload is the same as recipe download, simply change the "Download Recipe to PLC"/"Download Recipe" to "Upload Recipe from PLC"/"Upload Recipe". The recipe transfer function is consistent with the recipe transfer function achieved by the function keys. Below is an example of recipe transfer

2> Place corresponding controls based on the set parameters.

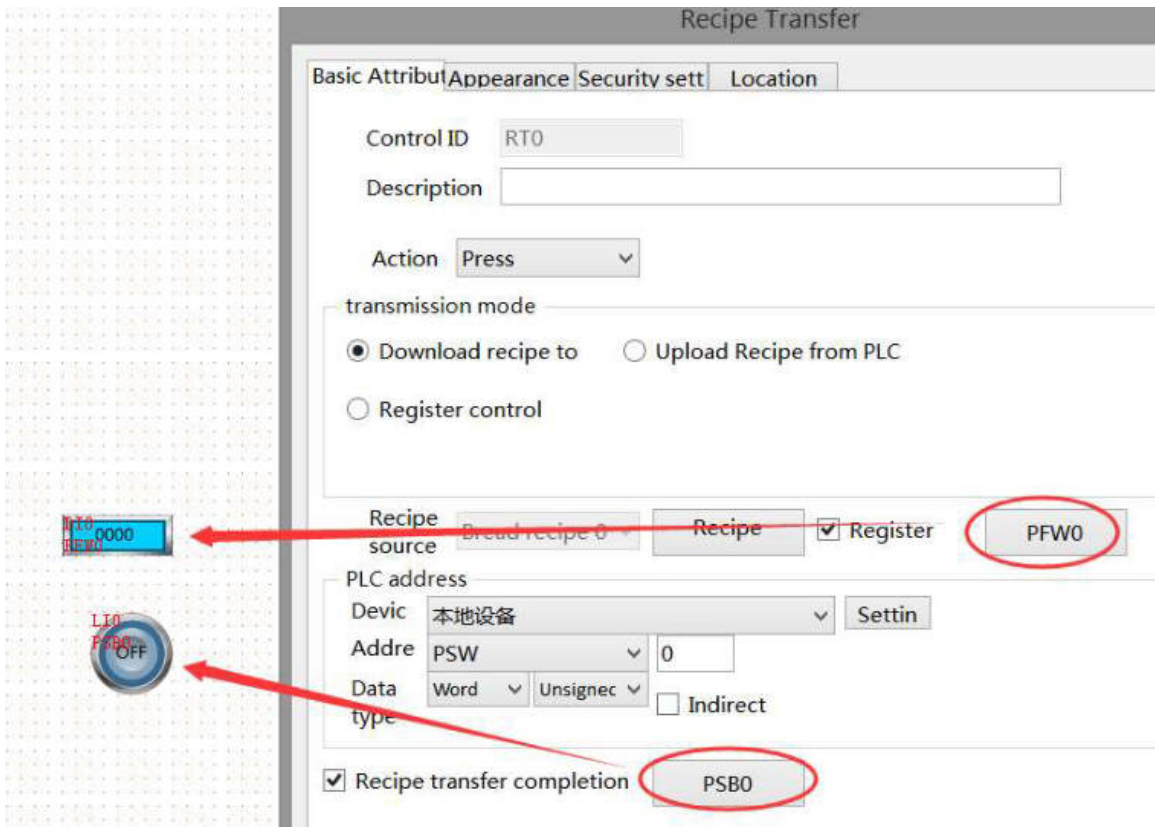

Note:

The address set by the PLC is shown in the following figure, starting from the first address and progressing sequentially according to the element data type address

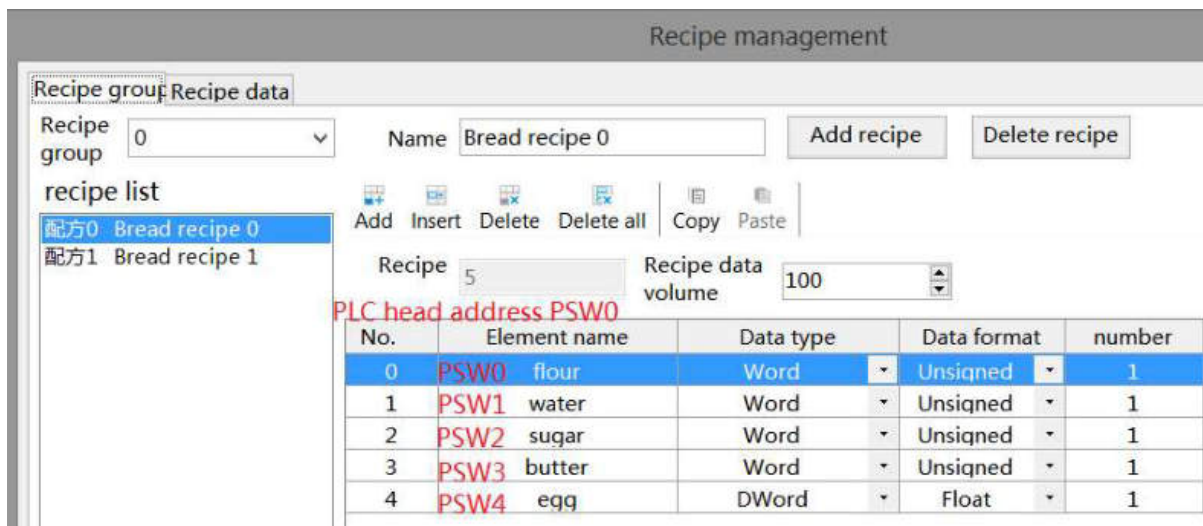

The data type of the PLC address should be consistent with the element data type set in the recipe table, such as egg element

4	egg	DWord	Float
---	-----	-------	-------

The data type is Dword-Float, then when setting PLC address, it needs to set to this type.



3. Put the recipe table on the screen

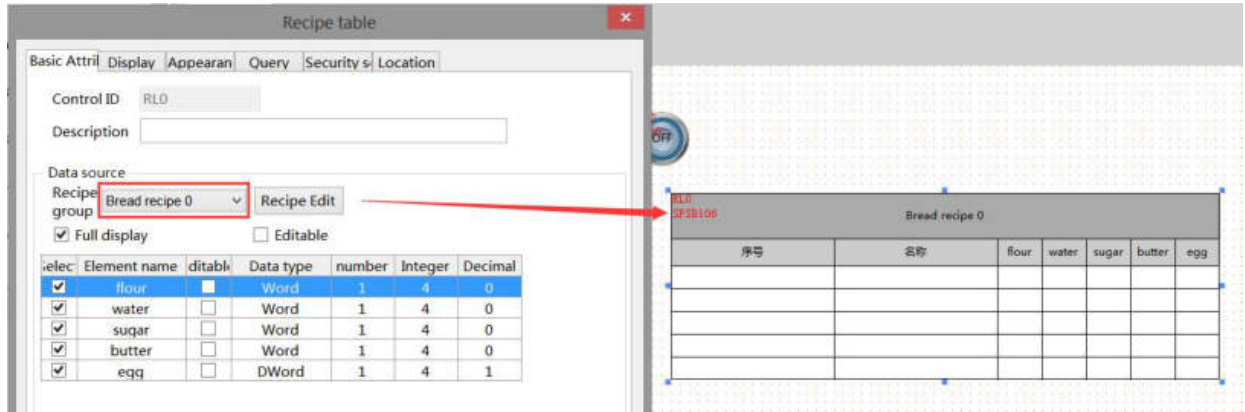

4. Put a recipe index register SPSW256.

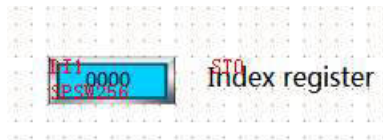

5. Take offline simulation as an example:

1> Recipe download

As shown in the following figure, change the register data of the specified recipe group to 0 and the index register to 3. Click the recipe download button. At this moment, download data 3 from recipe table 0 to PLC. After the download is completed, the recipe transfer completion flag will light up. To restore it, you need to manually set it to OFF.

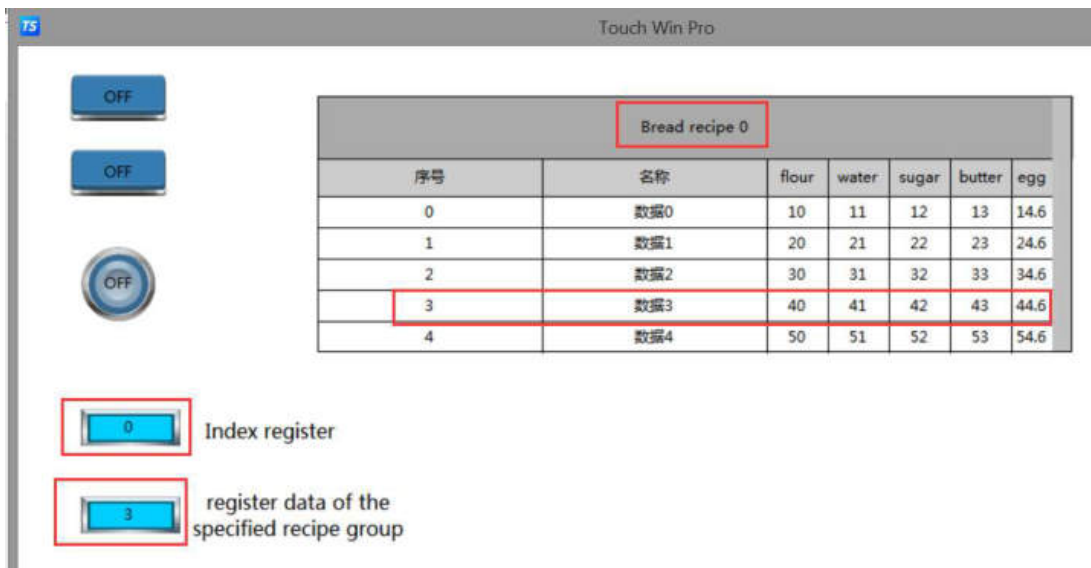

As shown in the following figure, change the register data of the specified recipe group to 1 and the index register to 0. Click the recipe download button. At this point, download the data 0 from recipe table 1 to the

PLC. After the download is completed, the recipe transmission completion flag will light up. To restore it, you need to manually set it to OFF.

Bread recipe 1						
序号	名称	flour	water	sugar	butter	egg
0	数据0	100	101	102	103	104.1044
1	数据1	200	201	202	203	204.2044
2	数据2	300	301	302	303	304.3044
3	数据3	400	401	402	403	404.4044
4	数据4	500	501	502	503	504.5044

2> Recipe upload

As shown in the following figure, change the register data of the specified recipe group to 0 and the index register to 0. Click the upload recipe button. At this point, upload the data from the PLC to the data 0 in the recipe table 0. After the upload is completed, the recipe transfer completion flag will light up. To restore, you need to manually set it to OFF.

Bread recipe 0						
序号	名称	flour	water	sugar	butter	egg
0	数据0	10	11	12	13	14.6
1	数据1	20	21	22	23	24.6
2	数据2	30	31	32	33	34.6
3	数据3	40	41	42	43	44.6
4	数据4	50	51	52	53	54.6

4-6-5. Event button



1. Click on the "Parts/Recipe/Event Button" icon in the menu bar or the " " icon in the device bar of the control window, move the cursor to the screen, click the left mouse button to place, click the right mouse button, or use the ESC key to cancel the placement. Modify the length and width of the border through the boundary point.

2. When setting attributes, you can set them in the attribute box that pops up when placing components. You can also double-click the "Event Button" or select the "Event Button" and right-click to select "attributes" for attribute settings.

■ Basic attributes

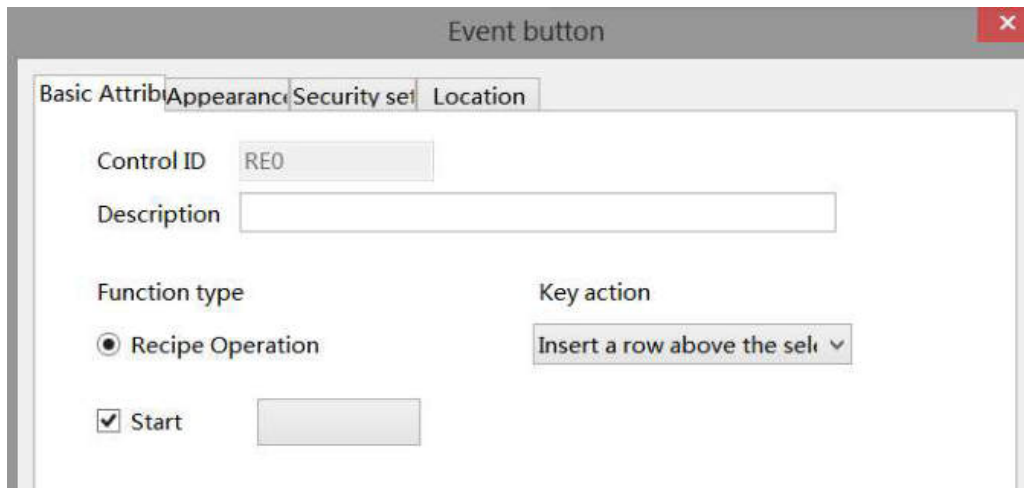

control ID	Used for system management controls, user cannot operate	
description	Can be used to annotate the purpose of this control	
function type	The recipe operation is checked by default and cannot be unchecked	
key action	Insert a row above the selected row	After selecting a row of recipe data in the recipe table, click this control to insert a row of data with empty name, empty data (the data type of the selected row element is string), or 0 (the data type of the selected row element is Byte, Word, DWord, DDWord) above the row
	Insert a row below the selected row	After selecting a row of recipe data in the recipe table, click this control to insert a row of data with empty name, empty data (the data type of the selected row element is string), or 0 (the data type of the selected row element is Byte, Word, DWord, DDWord) below the row
	delete selected row	After selecting a row of recipe data in the recipe table, click this control to delete the entire row in which it belongs
	copy selected row	After selecting a row of recipe data in the recipe table, click this control to add a blank row of recipe data with the same name as the row below it

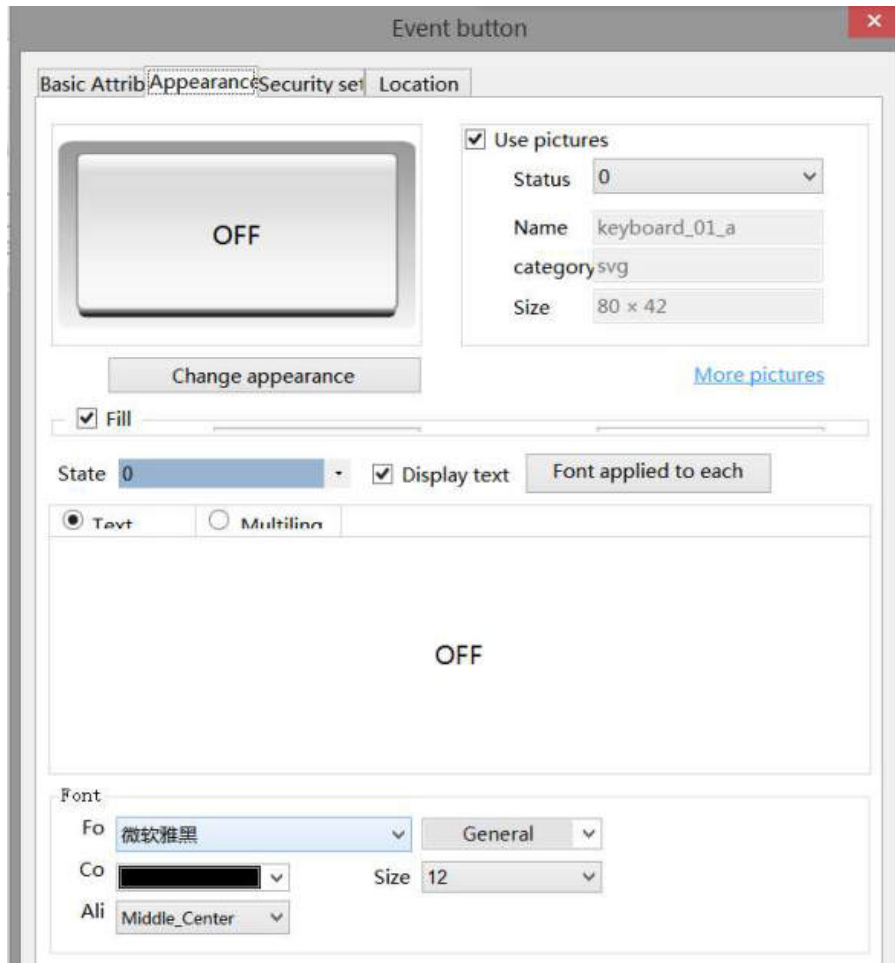

appearance	You can check whether to use images. If checked, you can set the appearance of the event button in two states (0, 1). After selecting the state in the upper right corner, click "Change appearance" or click "More pictures" to select custom images to change the appearance
fill	Can set fill styles (solid/gradient) and fill colors
state	The text prompt content of the event button can be set in two states (0, 1), and whether to use multiple languages can be set (for specific use of multiple language libraries, please refer to chapter 5-1 labels for multiple languages). Tick the drop-down list to set the font corresponding to the corresponding state of the event button, or click the " Font applied to each state" button behind to set the font for all states
font	Can set font, font style, color, size, and font display position in the control

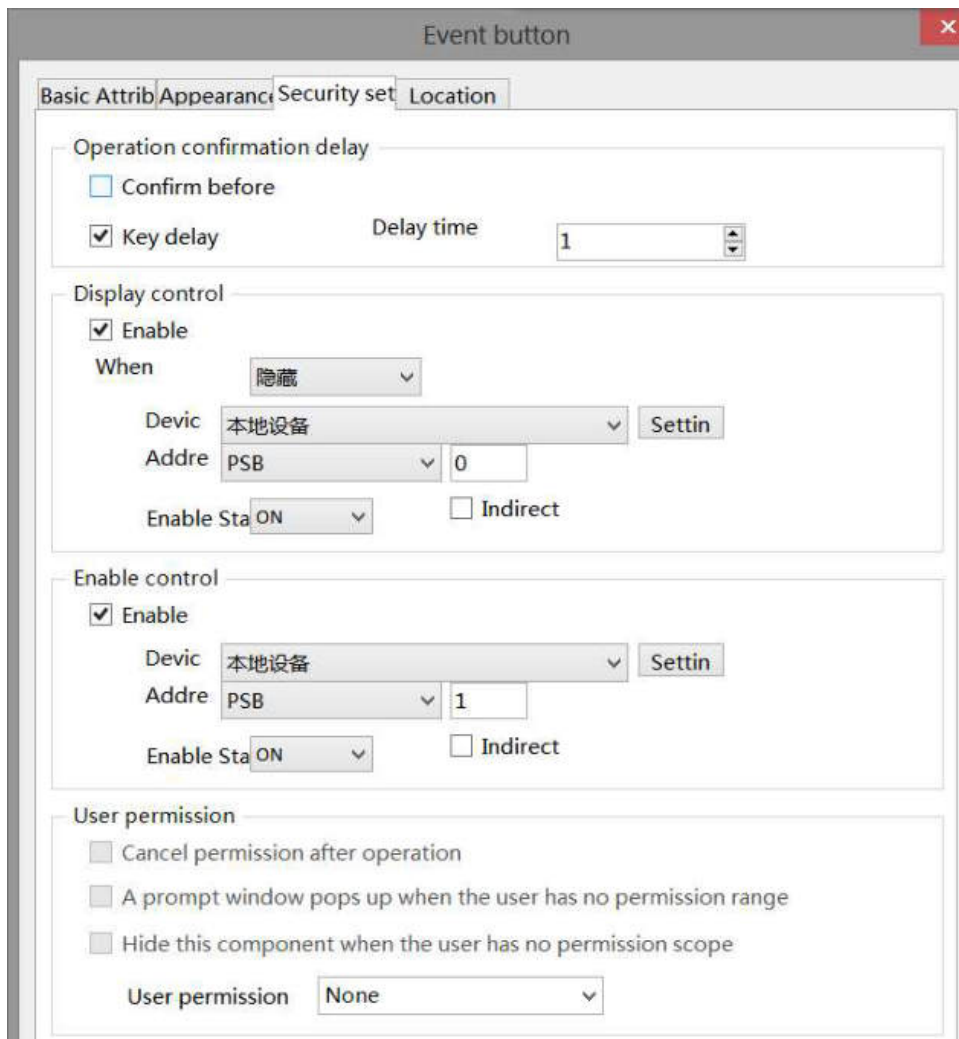

operation confirmation delay	You can set the delay time (s). If this option is checked, a pop-up window will appear when operating the component, saying "Are you sure to execute this operation?" If you do not click "confirm" or "cancel" within the set delay time, the pop-up window will disappear and the operation will fail. If you click 'OK' within the waiting time, the operation is successful, but clicking 'Cancel' is invalid
key delay	Long press the set delay time before the operation takes effect
display control	Use bit control to display the component. When the conditions are not met, the control is hidden and defaults to hidden, which cannot be modified
enable	When checked, display control will be enabled
When validation fails	Set the display of the control when validation fails
address	Set the target coil for positioning control
enable state	Set the ON state to be valid or the OFF state to be valid. Example: If the device is checked as shown in the above figure, the bit control is PSB0, and if verification fails, it will be hidden. If the enabled state is ON, the component will be displayed normally. If the PSB0 state is OFF, the component will be hidden and not displayed
enable control	Can be set with bit restrictions (customizable enabled state), and only when the enable conditions are met can the component be used normally (as shown in the figure above: when PSB1 is in the ON state and the trigger conditions are met, this component can be used; if PSB1 is in the OFF state, even if the trigger condition is met, this component is still unavailable)

user permission	<p>Set controlled permission levels</p> <p>After setting the required user's permission range, the following three functions can be checked according to the needs.</p> <p>(1) After the operation is completed, the usage permission will be cancelled: if this option is not checked, the corresponding level password needs to be entered every time the component is operated. After checking, only one successful input is required.</p> <p>(2) When the user has no permission range, a prompt window will pop up.</p> <p>(3) When the user does not have permission range, hide the component.</p>
-----------------	---



The function of permission please refer to chapter 4-2-3 value input.

- Location

Same to chapter 4-1-1 straight line location part.

4-7. Operation record

4-7-1. Operation record setting

This control can record the user's usage steps and content of other operable controls, and display them through the "Operation Record Display". This function can be used to assist in analyzing operational processes and problem points.

Click on the menu bar 'Parts/Operation Record/Operation Record' or click  in the toolbar to enter the operation record configuration interface. After checking the enable operation record, the display is as follows:

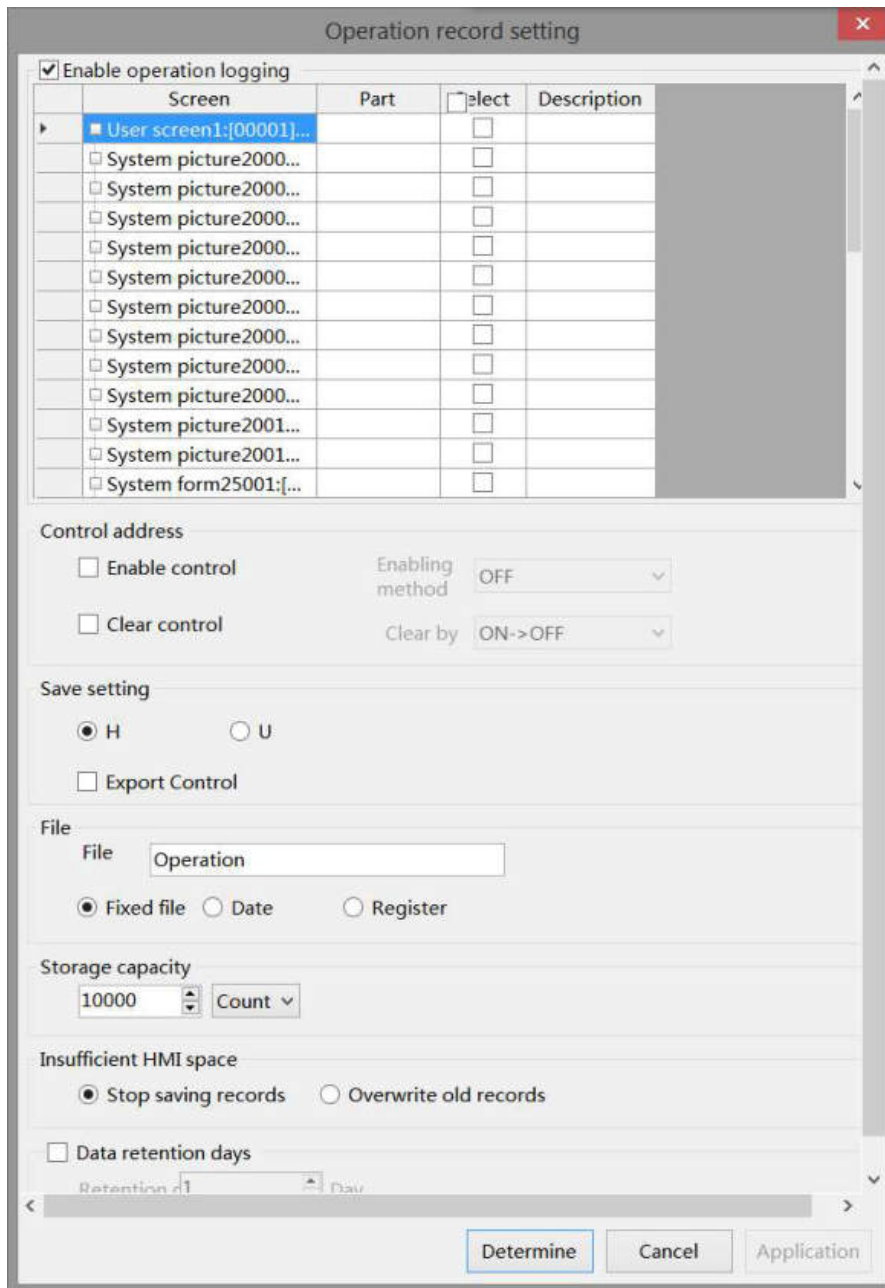

select

Select to indicate that if the control is operated, the operation record will be displayed on the "Operation Record Display"; You can click the "☐" sign to expand the controls in the screen and set whether to check them.

Screen	Part	Screen	Part
☑ User screen1:[00001]...		☑ User screen1:[00001]...	
☐ System picture2000...		☐ 窗口1:[00001]Page1	Recipe Tra...
☐ System picture2000...		☐ 窗口1:[00001]Page1	Function k...
☐ System picture2000...		☐ 窗口1:[00001]Page1	Value inpu...
☐ System picture2000...		☐ 窗口1:[00001]Page1	Value inpu...
☐ System picture2000...		☐ System picture2000...	
☐ System picture2000...		☐ System picture2000...	



When checking User Screen 1, it represents checking all the controls in User Screen 1, and unchecking is the same; When you only want to monitor the operation of a certain control in screen 1, simply select the control you want to monitor.

control address	<p>Set the register for HMI export control (if set to PSW0, three consecutive addresses with PSW0 as the first address will control different states), which can be viewed by clicking on the blue font "Control Address Information" in the bottom right corner</p> <div data-bbox="368 342 903 835" style="border: 1px solid gray; padding: 5px; margin: 10px 0;"> <p style="text-align: center;">Prompt ✕</p> <p>Command:PSW0</p> <p>1. Export operation records to USB flash disk 2. Export operation record to USB flash disk</p> <p>speed of progress:PSW1</p> <p>1.The value of 0-100 indicates the progress,</p> <p>result:PSW2</p> <p>0. Data export</p> <p>1. Data export succeeded</p> <p>2. The export device does not exist</p> </div> <p>Note: 1. This function only takes effect when the storage location is selected as HMI or when "register specified storage location" is specified as HMI.</p> <p>2. When inputting 4 and 6 to the command register, the database can be controlled to be exported to a USB drive, and the exported file format is xjdb. The xjdb to CSV tool can be opened by double clicking on the software root directory \Tool\XJDbTool\XJDbTool.exe, which is set as the default opening method for xjdb. After opening, enter the path name of the CSV and click "Export" to convert the xjdb format file to a CSV format file.</p>
save setting	<p>Set the storage address, which can be specified by selecting HMI, USB flash drive, or register</p> <div data-bbox="368 1182 427 1238" style="display: inline-block; vertical-align: middle;">  </div> <p>When simulating, the storage location displayed for the operation record is:</p> <p>(1) Save to USB drive: Software directory: Temp/Run/storage/udisk/history</p> <p>(2) If you choose to save to the hmi: software directory Temp/Run/db/history, the saved file cannot be directly opened for viewing. To view it, you need to export to a USB drive and then view the exported file in the path saved to the USB drive</p>
file	Set the file name for storage, and the system will store data with this name
fixed file	The stored file name is fixed, which is the name set in the file name (the file name can support up to 200 characters)
date	The stored file name is named with a date, for example, the file exported on May 29, 2021 is named 20210529
register	Set the register address, and the stored files will be named based on the contents of the register. When selecting dynamically specified file name, it is necessary to select a string type register such as character input and Chinese input. (File names can support up to 200 characters)
storage capacity	Set the total amount of collected data information stored; Maximum storage capacity 65535 pieces
insufficient HMI space	Set the status to stop saving or overwriting old records when storage space is insufficient
stop saving records	After checking, stop saving data when storage space is insufficient
overwrite old	After checking, when the storage space is insufficient, it will continue to save and overwrite



Note: Whether you choose "fixed file name" or "dynamically specified file name" for the saved file name, the following characters are not supported in the file name: \ / : * ? " < > | - # ; \$! @ & ()

4-7-2. Operation record display

1. Click on "Parts/Operation Record/Operation Record Display" icon in the menu bar or the "  " Operation Record Display "icon in the device bar of the control window, move the cursor to the screen, click the left mouse button to place, click the right mouse button or use the ESC key to cancel the placement. Modify the length and width of the border through the boundary point.
2. When setting attributes, you can set them in the attribute box that pops up when placing components. You can also double-click on "Operation Record Display" or select "Operation Record Display" and right-click to select "attributes" for attribute settings.

■ Basic attributes

Select	Project	Title	Title Description	Column spacing
<input checked="" type="checkbox"/>	序号		序号	35
<input checked="" type="checkbox"/>	日期		日期	82
<input checked="" type="checkbox"/>	时间		时间	62
<input checked="" type="checkbox"/>	控件ID		控件ID	56
<input checked="" type="checkbox"/>	控件描述		控件描述	56
<input checked="" type="checkbox"/>	地址		地址	220
<input checked="" type="checkbox"/>	动作		动作	55
<input checked="" type="checkbox"/>	用户名		用户名	56
<input checked="" type="checkbox"/>	窗口		窗口	56
<input checked="" type="checkbox"/>	操作信息		操作信息	139

control ID	Used for system management controls, user cannot operate
description	Can be used to annotate the purpose of this control
Operation Record Settings	Click on "Operation Record Settings" to set the relevant content of the operation record
use	If the list displayed in the operation record is in multiple languages, check this option. When

multi-language	using multiple languages is checked, a multi language setting table will be displayed on the right side of the title description. Clicking on it will lead to the multi language library setting interface for setting multiple languages. The use of multiple languages can be found in labels chapter 5-1. Multiple languages	
adaptive column space	After checking, the column width cannot be customized, and the software will automatically adjust it to the most suitable size based on the project screen	
select	Only when checked can it be displayed in the list	
No.	Display the sequence number of table columns	If you need to adjust the order of items, you can click the "Move Up, Move Down" button below. If you want to restore the default sorting, you can click "Restore Default Sorting"
date	Date generated during control operation	
time	Time generated during control operation	
control ID	The ID number of the control	
control description	Description content of the control	
address	The address of the control, which can display whether it is an internal or external address	
action	Set Word, Set ON, Set OFF, Toggle (bit reverse), Write Const Value, Write String, Return To Prev Window, Go To Next Window, Upload recipe, Download recipe, Press, Release	
user name	Do you have user privileges to log in at this time? If not logged in, it will not be displayed	
window	The window number where the control is manipulated	
operate infomation	Bit Set ON Bit Set OFF Write (Initial value) ->(Input value) Bit Set ON->OFF Bit Set OFF->ON Write newVal Write (Initial string) ->(Input string) Window (Current page) ->(Jump to page) Upload (recipe name) download (recipe name)	
order	Set the information display mode and select whether the latest operation record is displayed before or after	
chronological order	According to the order in which the operation record time is generated, the first generated one is displayed at the top, and the later generated one is displayed at the bottom, that is, the latest operation record is displayed at the bottom of the table	
reverse chronological order	Contrary to the chronological order, the first generated operation record is displayed at the bottom, and the later generated operation record is displayed at the top, that is, the latest operation record information is displayed at the top of the table	
time date format	set the date and time format	



When using multiple languages is checked, "..." will be displayed in the bottom right corner of the title description. Clicking on it will lead to the multi language library setting interface to set multiple languages.

■ Display

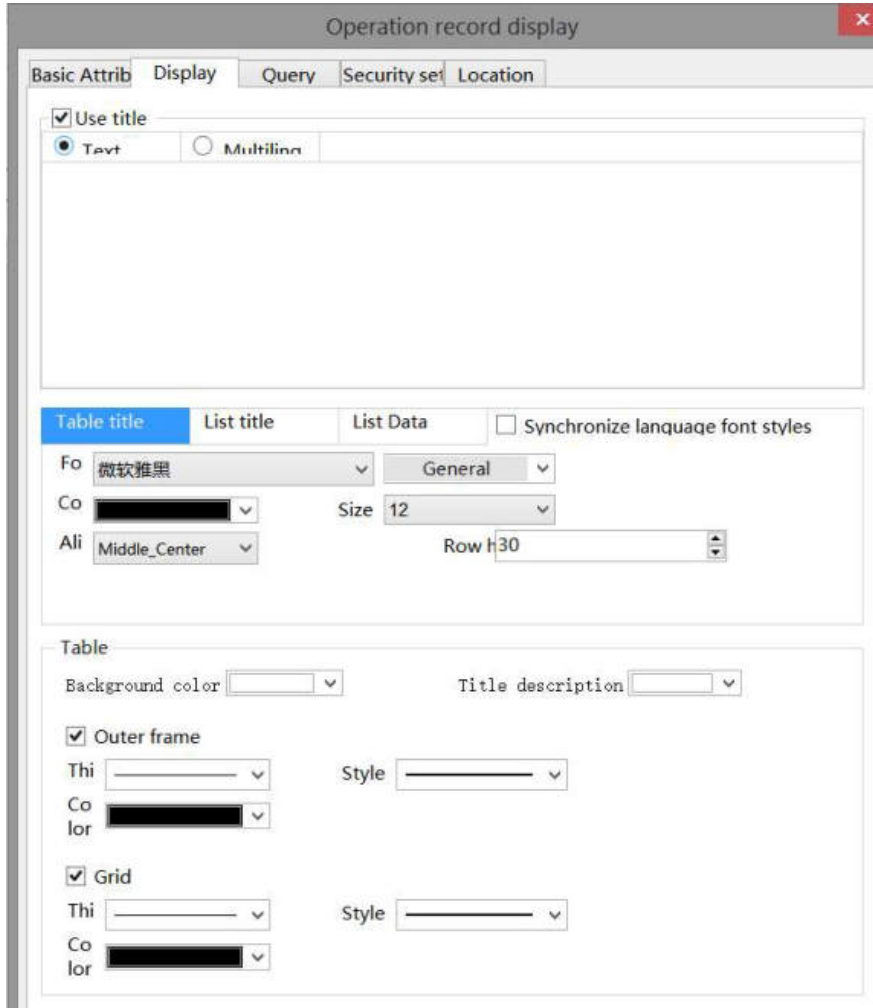

use title	text	Set the name of the operation record display header
	multiling	After checking, the header content can be set to multiple languages (refer to 5-1 for details on using multiple languages)
synchronize language font styles		If unchecked, the title font and list font can be set separately If checked, the two fonts, colors, sizes, and alignment remain consistent
font		Font, color, size, and alignment can be set
table	background color	Set the background color of the table
	title background color	Set the background color of the table title
	outer frame	The thickness, style, and color of the outer frame can be set, and will only be displayed when checked
	grid	The thickness, style, and color of the grid can be set, and will only be displayed when checked



When “synchronize language font styles” is checked, all fonts display the title font.

■ Query

① Export

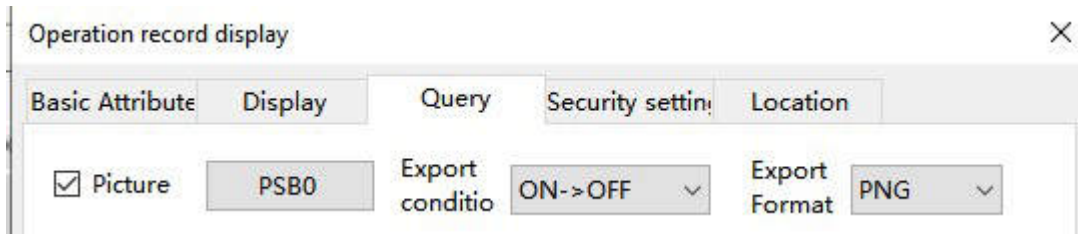

Select **Picture** to use the picture export function. Meets export conditions, export format is PNG.

② Query

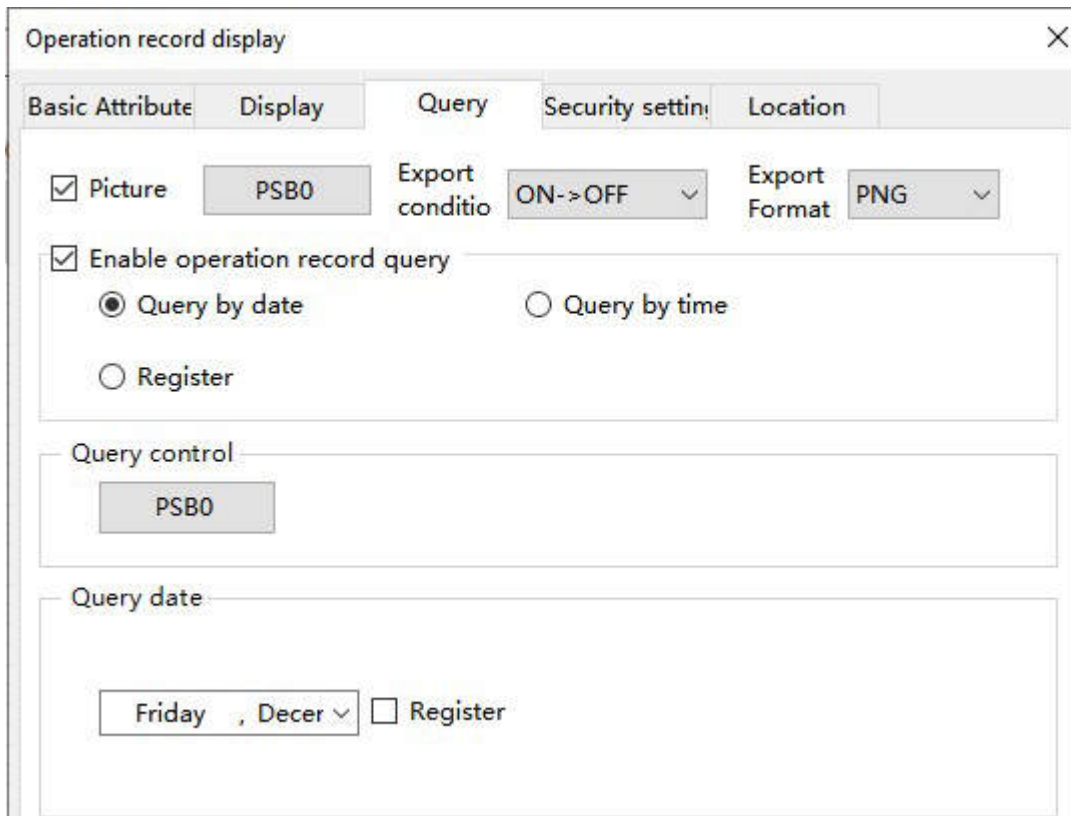

The information found will be displayed in the operation record display table. If you need to use this function, check the "Enable operation record query" function.

There are two query methods: query by date and query by time period. These two query methods can be freely selected by users or dynamically specified through registers, as follows:

query control	Set an address, and when set to that address, the query function will be triggered, and the query results will be displayed in the table
---------------	--

(1) Query by Date

Entering the date to be queried will filter out all operation record information under this date and display it in the table.

Query control

PSB0

Query date

Tuesday , April Register

You can also choose "Register" to dynamically set the query address. As shown in the following figure, setting a first address, such as PSW0, will occupy a total of three addresses from PSW0 to PSW2. PSW0 represents year, PSW1 represents month, and PSW2 represents day, all of which are single word unsigned numbers. For example, PSW0=2021, PSW1=5, and PSW2=29, the operation record information for May 29, 2021 will be queried.

Query date

Tuesday , April Register PSW0

For example: PSW0: year (unsigned number input, YYYY format)
 PSW1: Month (unsigned number input, mm format, for example, 01 for January, 02 for February, 03 for March, 04 for April, 05 for May, 06 for June, 07 for July, 08 for August, 09 for September, 10 for October, 11 for November, 12 for December)
 PSW2: Day (unsigned number input, DD format, for example, 01 for the first day of the month, 02 for the second day of the month, 03 for the third day of the month, 04 for the fourth day of the month, 05 for the fifth day of the month, 06 for the sixth day of the month, 07 for the seventh day of the month, 08 for the eighth day of the month, 09 for the ninth day of the month, 10 for the tenth day of the month, 11 for the eleventh day of the month, 12 for the twelfth day of the month, 13 for the thirteenth day of the month, 14 for the fourteenth day of the month, 15 for the fifteenth day of the month, 16 for the sixteenth day of the month, 17 for the seventeenth day of the month, 18 for the eighteenth day of the month, 19 for the nineteenth day of the month, 20 for the twentieth day of the month, 21 for the twenty-first day of the month, 22 for the twenty-second day of the month, 23 for the twenty-third day of the month, 24 for the twenty-fourth day of the month, 25 for the twenty-fifth day of the month, 26 for the twenty-sixth day of the month, 27 for the twenty-seventh day of the month, 28 for the twenty-eighth day of the month, 29 for the twenty-ninth day of the month, 30 for the thirtieth day of the month, 31 for the thirty-first day of the month)

(2) Query by time period

Enter the start and end times to be queried in the specified address, set the query control address, and display all information filtered out during this time period in the table.

Query time period

From Tuesday , April 11 Hour 44 Minute Second

To Tuesday , April 11 Hour 44 Minute 32 Second

Register

Similarly, register control can also be used. After setting the first address, 12 register addresses, including the first address, will be occupied. The first 6 addresses represent the year, month, day, hour, minute, and second of the start time, and the last 6 addresses represent the year, month, day, hour, minute, and second of the end time. The format is consistent with manual settings.

Query time period

From Tuesday , April 11 Hour 44 Minute Second

To Tuesday , April 11 Hour 44 Minute 32 Second

Register PSW

Example: PSW0~PSW5: from time year, month, day, hour, minute, and second
 PSW6~PSW11: refers to the time year, month, day, hour, minute, and second

(3) Register Control Query Method

Use registers to dynamically specify the query method. A register value of 0 indicates querying by date, and a value of 1 indicates querying by time period. Users can choose according to their own needs.

- Security setting

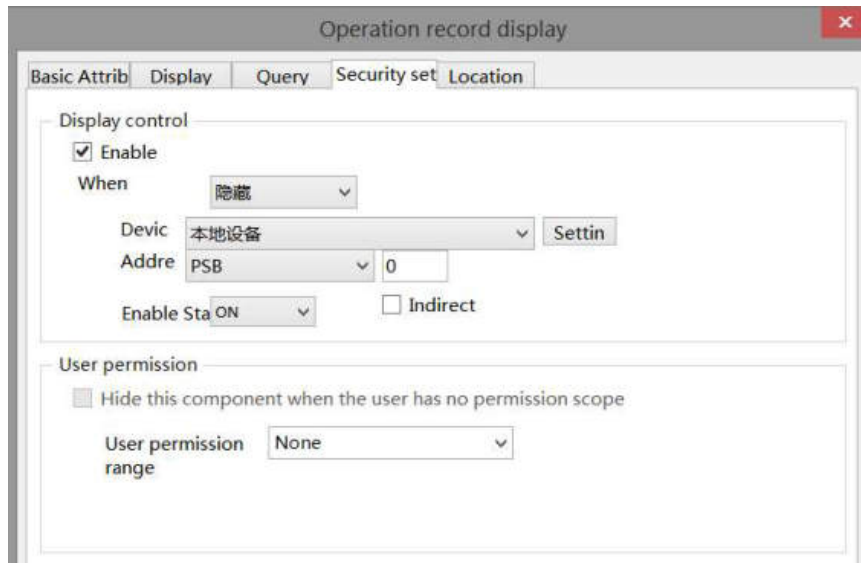

Same to chapter 4-1-1 straight line security setting part.

- Location

Same to chapter 4-1-1 straight line location part.

4-8. Hire purchase

1. Function enter

Click Menu bar-Tool-Hire purchase or click  in the tool bar.

2. Function introduction

Implement installment payment for equipment and perform lock and encryption processing on the equipment. The installment configuration is completely user-defined, including the number of installment periods, the expiration date of each installment, and the password for each installment. Configuration information needs to be maintained by customers themselves, and this feature has the advantages of free configuration and high security.

4-8-1. Static installment payment

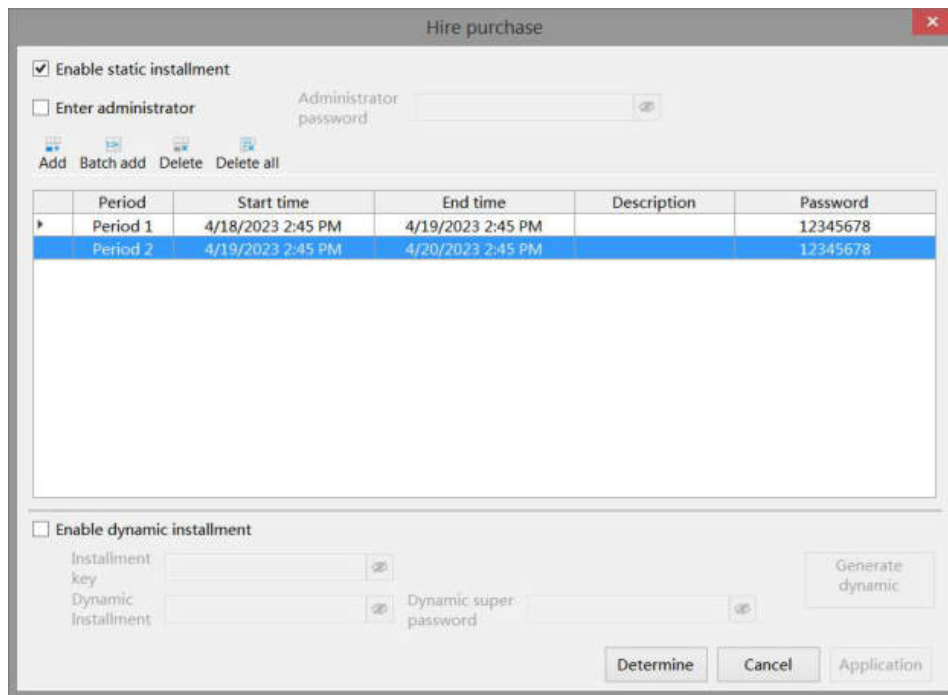

- Check "Enable static installment ", add the number of installment periods, set the start time, end time, description, and password.
- Enter administrator password to cancel installment payment: If this option is checked in the project, set the administrator password and download it. In any installment payment pop-up window that pops up, enter the custom administrator password, which will cancel subsequent installment payments and close the window to enter the project operation page. Passwords support letters (case sensitive) and numbers, with a password length limit of 10 characters.

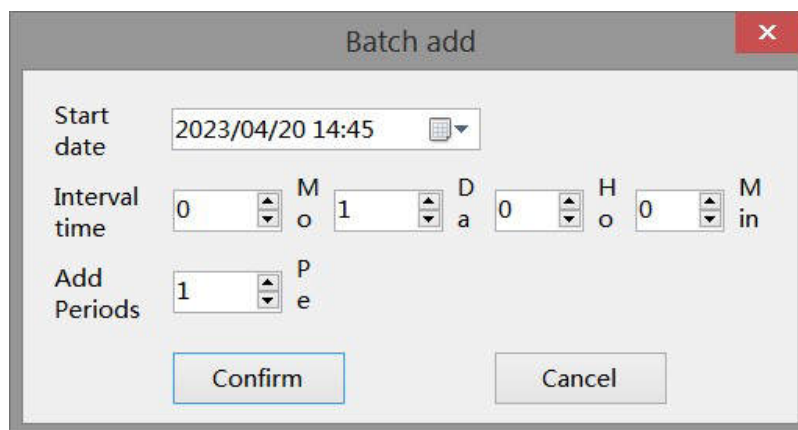

- Add: Click "Add" and add an installment payment setting in order at the bottom of the table. You can set the start and end dates, time, and password yourself.
- Batch Add: Click "Batch Add" to set multiple installment payments (up to 60 installments). Set the start time, date, interval time, and number of batch copies independently. Click OK and it will be displayed below. You can set the start and end date, time, and password by yourself.
- The time supports selection and input, and the description can be edited. The default password is 12345678. The password supports letters (case sensitive) and numbers, and the length of the password is 20 characters, which can be modified. The maximum number of sessions is 60, and the end time of the previous session defaults to the start time of the following session. All start and end times can be modified.
- Delete: Click a row in the installment payment table, select it with the cursor, and then click "Delete"

to delete the installment payment

- Delete All: Click 'Delete All' to clear all installment payment settings.

HMI display:

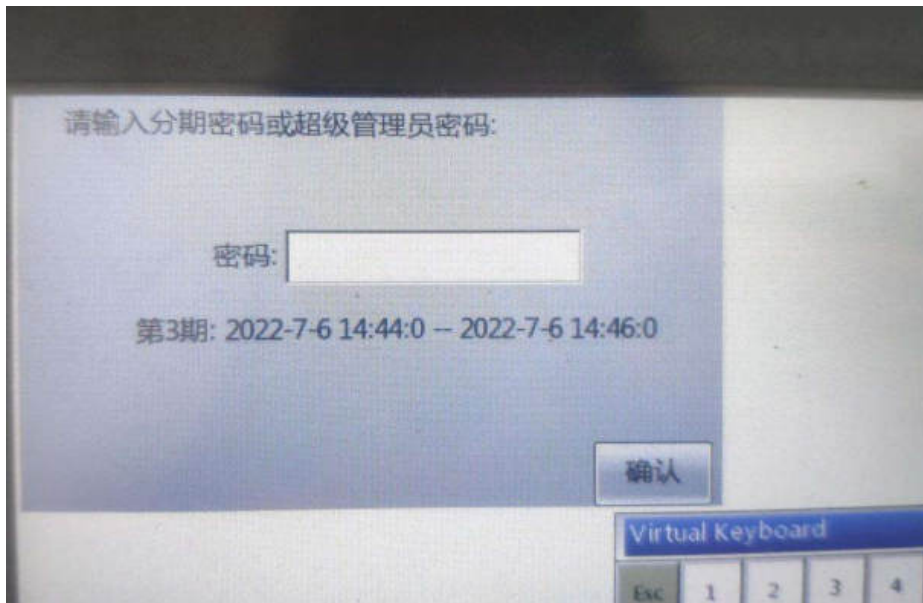

When the start time of installment payment is reached, a pop-up window will pop up in the upper right corner of the HMI. At this time, only the installment payment password can be entered, and the rest of the screen is not clickable; Enter the current password in the pop-up window to use it normally until the start date of the next installment. If the password is entered incorrectly, it will prompt for an incorrect password input, and you must re-enter the correct password to use it properly.



The difference between an administrator password and a regular installment password is:

- 1. The administrator password means that regardless of the installment payment period, simply entering the "administrator password" will cancel the installment payment function. The regular installment password is only used to confirm the current installment payment, and subsequent installments will still pop up at the set start time.**
- 2. Password settings for both: The password can have up to 10 digits and supports letters (uppercase and lowercase) and numbers.**

4-8-2. Dynamic installment payment

- Enable dynamic installment

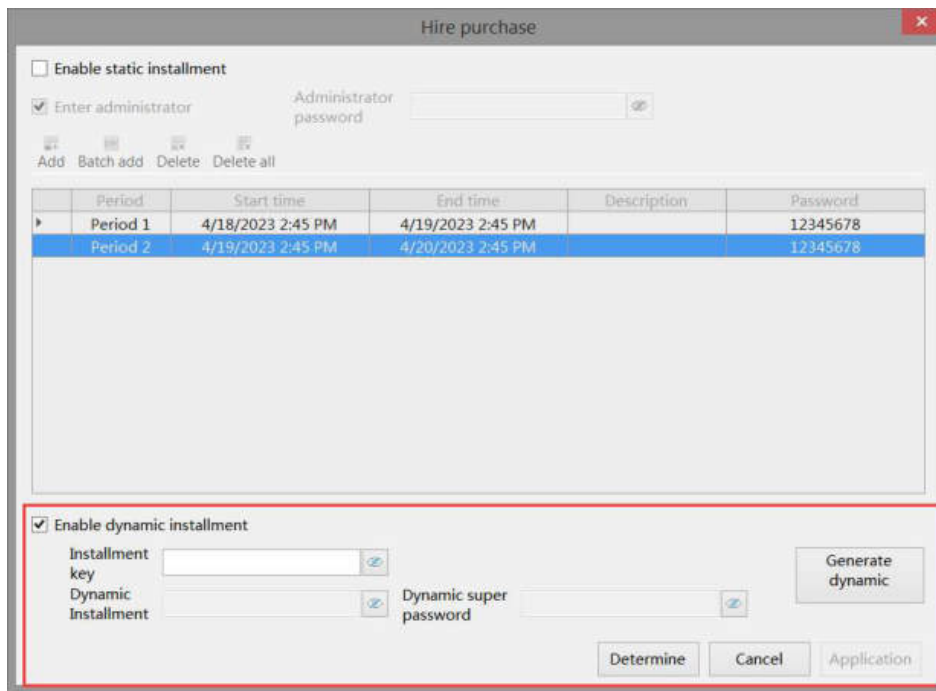

Only by checking this option can dynamic installment payments be set.

installment key	The password includes uppercase and lowercase letters and numbers, and the length does not exceed 10 digits; You can also enter the installment key in the "Generate dynamic" interface, and the passwords in both places are synchronized
dynamic installment	The password is automatically generated by the system. The dynamic password on this interface can only be viewed and copied, and cannot be edited
dynamic super password	The password is automatically generated by the system, and the dynamic super password on this interface can only be viewed and copied, and cannot be edited



The dynamic password and dynamic super password are both 32-bit. When copying the password, manually select all with the mouse and copy it when the password is visible.

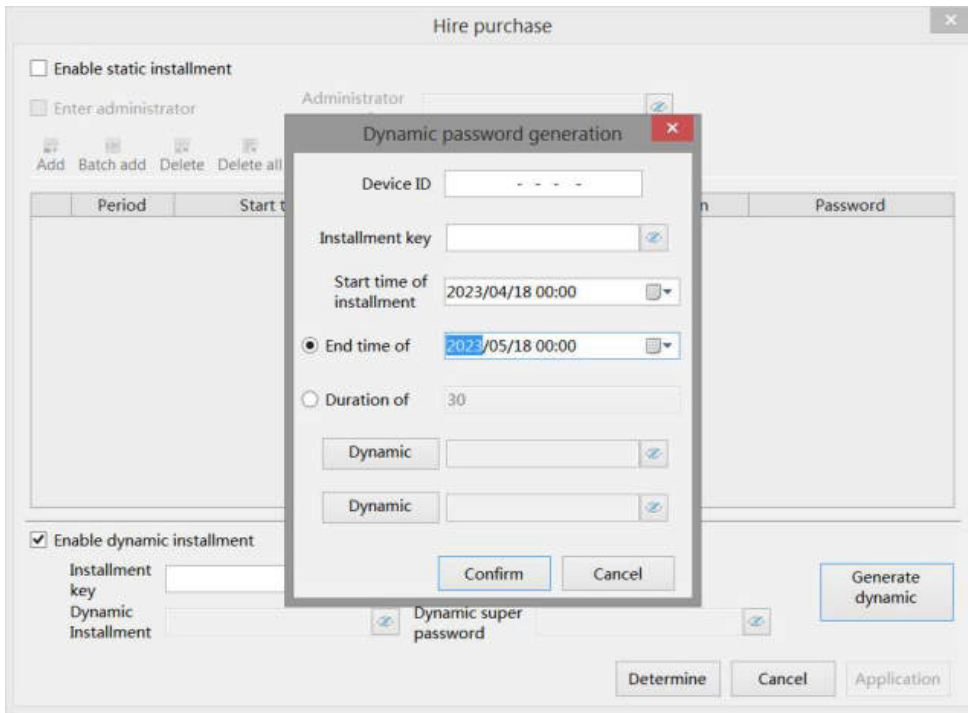

- Generate dynamic password

Click “generate dynamic” to enter dynamic installment password interface.



device ID

Each screen only has a unique device ID, and there are three ways to query the screen ID;

1. click  on the lower right corner of HMI screen, select , it will pop up a window, the red color area is the device ID.

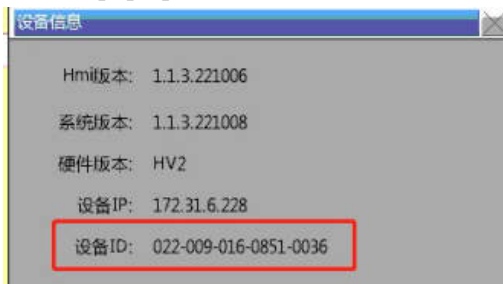

2. check the ID on the product label.

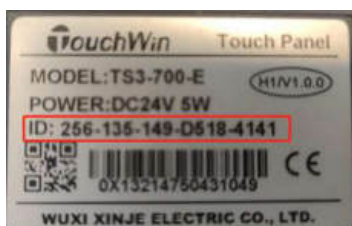

3. When downloading, select the LAN download and scan the IP interface to find the required device ID based on the model and IP address

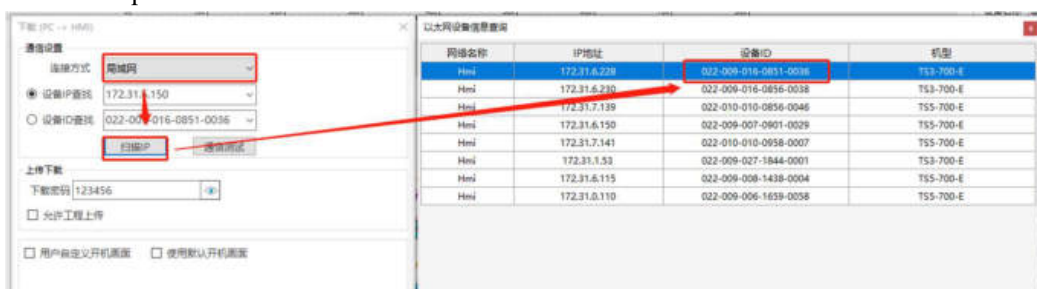

installment key

The password includes uppercase and lowercase letters and numbers, and the length does not

	exceed 10 digits; You can also enter the installment key in the "installment payment" interface, and the passwords in both places are synchronized
start time of installment	Set the start time for the required installment encryption
end time of installment	Set the end time for the required installment encryption
duration of installment	Set the required duration for installment encryption
dynamic password	The password is automatically generated by the system, and the dynamic installment password on this interface can only be viewed and cannot be copied or edited. Click on "Dynamic password" and the dynamic installment password will be automatically generated. This password is used for decryption during the current period and is associated with the device ID, installment key, and time (start time, end time/duration). As long as one of the parameters is modified, you need to click on "Dynamic Password" again. The password will be updated. If no parameters are modified, the password will not be updated.
dynamic super password	The password is automatically generated by the system, and the dynamic super password on this interface can only be viewed and cannot be copied or edited. Click on 'Dynamic Super Password' and the dynamic super password will be automatically generated. This password can lift all installment restrictions and has the highest authority to lift them. And it is only related to the device ID and installment key, and is not related to the installment time. If you modify the device ID or installment key, you need to click on "Dynamic Super Password" again to update the password. If you do not modify any parameters, the password will not be updated.



In the pop-up window, enter the device ID, installment key, start time, and then select the end time or enter the duration. Entering the installment end time can automatically calculate the duration (one decimal place). Both are required items, otherwise dynamic installment passwords and dynamic super passwords cannot be successfully generated.

■ HMI display

When entering the installment state, the HMI automatically enters the lock interface and prompts the user to enter the corresponding password.

If the installment password is entered correctly, it will prompt the remaining available days (which is consistent with the installment duration), and the system screen can continue to use normally within the duration range.

If the super password is entered correctly, it will prompt for permanent use; If the password is entered incorrectly, click OK and prompt "Incorrect password input".

If no password has been entered, click OK and a prompt will appear stating 'Password input is blank'. And the current interface window cannot be closed.

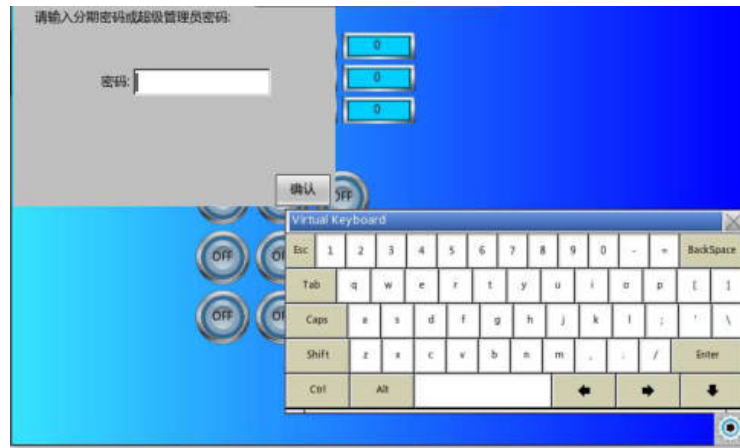



4-9. Special component

4-9-1. Timer

1. Click Parts/industry/timer or the  icon in the device bar of the control window, move the cursor to the screen, click the left mouse button to place, click the right mouse button, or use the ESC key to cancel the placement.
2. When setting attributes, you can set them in the attribute box that pops up when placing components. You can also double-click on "Timer" or select "Timer" and right-click to select "attributes" for attribute settings.

- Basic attributes

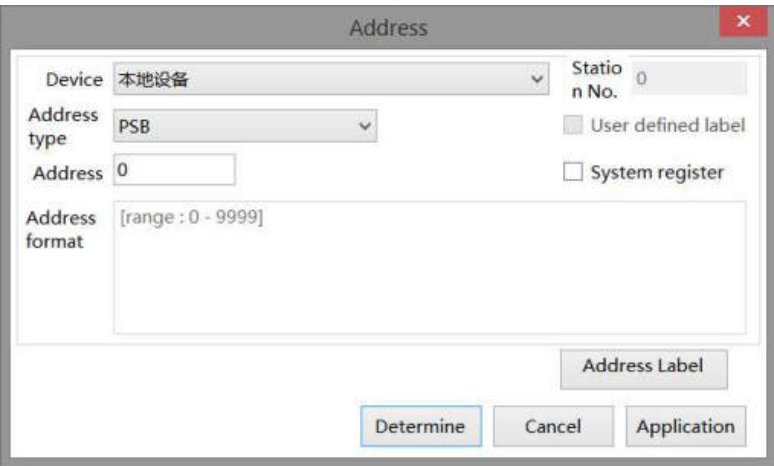
control ID	Used for system management controls, user cannot operate
description	Can be used to annotate the purpose of this control
time unit	The minimum unit is 0.1 seconds, seconds or minutes
delay/execution cycle	After setting, the timer will only start executing after the set cycle time is executed when the trigger conditions for the timer are met
timer execution flag bit	When executing, the target coil lights up and goes out after the execution is completed
device	The device port currently communicating with
address	Set target coil number
setting	Click "Settings" to enter the address setting interface. This interface allows you to set the use of system registers and user-defined labels. You can click on the address label library or the project tree - library - address label library below to set the labels used (refer to 5-2 Address Label Library for the use of address label library and user-defined labels)

		
trigger conditions	bit state change	<p>When the bit state of the coil that triggers the address is either the rising or falling edge, timing begins</p> <p>Trigger conditions <input checked="" type="radio"/> Bit state change) Word value cha <input type="radio"/> Screen start</p> <p>Trigger ac PSB0 Trigger co Rising e</p>
	word value change	<p>Start timing when the data in the trigger address register changes (if "equal value" is checked, it means timing starts when the data in the trigger address register is equal to the set value)</p> <p>Trigger conditions <input type="radio"/> Bit state change) Word value cha <input type="radio"/> Screen start</p> <p>Trigger ac PSW0 <input checked="" type="checkbox"/> Equal value 5</p>
	screen start	<p>Start timing when the screen where the timer is located starts</p> <p>Trigger conditions <input type="radio"/> Bit state change) Word value cha <input checked="" type="radio"/> Screen start</p>
	screen end	<p>When the screen where the timer is located is closed, the execution flag bit lights up</p>
end condition	stop when screen is closed	Stop timing when the screen where the timer is located is closed
	stop when the preset time is reached	Stop timing when the timer reaches the preset time
	bit state changed	Stop timing when the bit state of the coil is either the rising or falling edge
preset time	constant	You can directly select a number and change it, or you can click  to change the time
	specified by register	The number in the register is the preset time

		Preset time <input type="radio"/> Constant <input checked="" type="radio"/> Specified by register Read address Devic 本地设备 <input type="button" value="Settin"/> Addre PSW 0 Data type Word Unsignec <input type="checkbox"/> Indirect
timer arrival preset time notice		Specify a coil, and when the timer reaches the preset time, the coil is ON/OFF
time counted		Counted time can be displayed by specifying a register that displays the real-time cumulative time after triggering
reset bit		Specify a coil. When the set trigger condition (ON/OFF) is met, the time will be reset, the arrival notification will be reset, and all status bits will return to their default state. To start the timer, a new trigger is required

■ Security setting

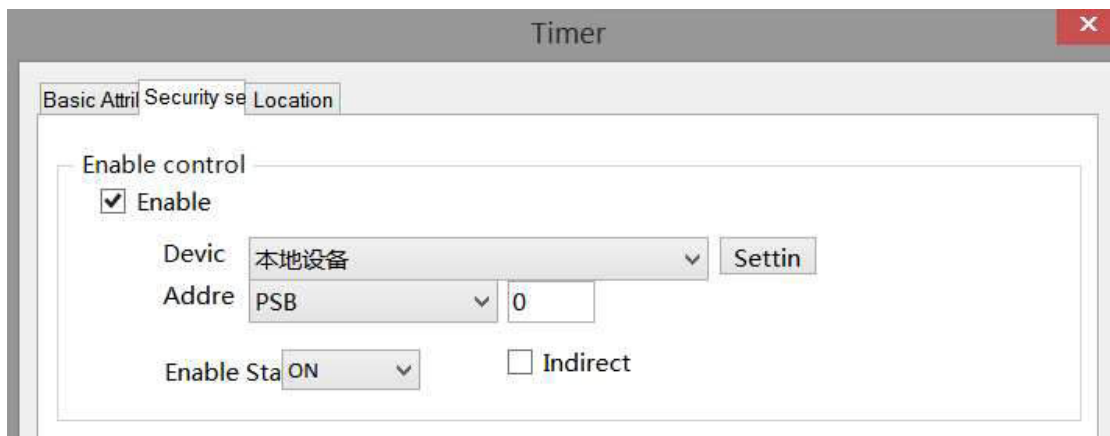

enable control	Can be set with bit restrictions (customizable enabled state), and only when the enable conditions are met can the component be used normally (as shown in the figure above: when PSB0 is in the ON state and the trigger conditions are met, the component can be used; if PSB0 is in the OFF state, even if the trigger condition is met, the component is still unavailable)
----------------	---

■ Location

Same to chapter 4-1-1 straight line location part. (Cannot make size modifications or move horizontally or vertically)

4-9-2. Scrolling text

To achieve the effect of trotting horse lamp for the text:

1. Click on the "Parts/Text/Scrolling Text" icon in the menu bar or the  icon in the special component bar of the control window, move the cursor to the screen, click the left mouse button to place, click the right mouse button or use the ESC key to cancel the placement. Drag the boundary point to modify the length and width of the border.

2. When setting attributes, you can set them in the attribute box that pops up when placing components. You can also double-click on "Scrolling Text" or select "Scrolling Text" and right-click to select "attributes" for attribute settings.

■ Basic attributes

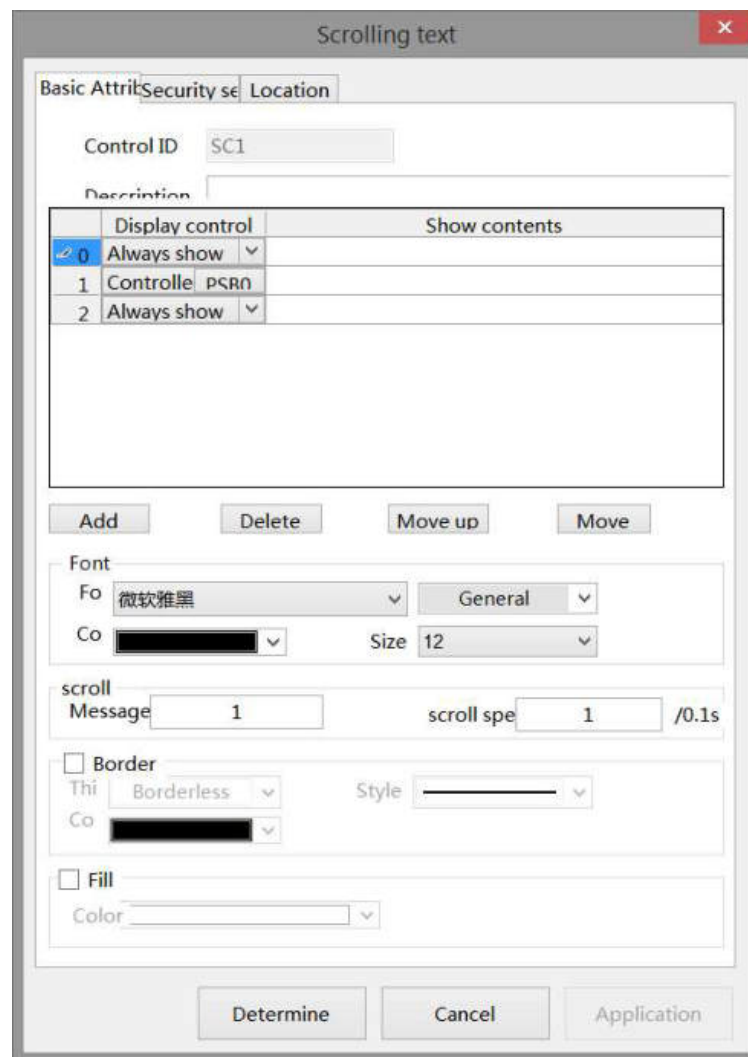

control ID	Used for system management controls, user cannot operate
description	Can be used to annotate the purpose of this control
display control	include always show and controlled by coil
always show	Right click and select the item to be displayed directly in the displayed content



controlled by coil To set the address of the triggering coil first, then right-click and select the item to be displayed in the displayed content

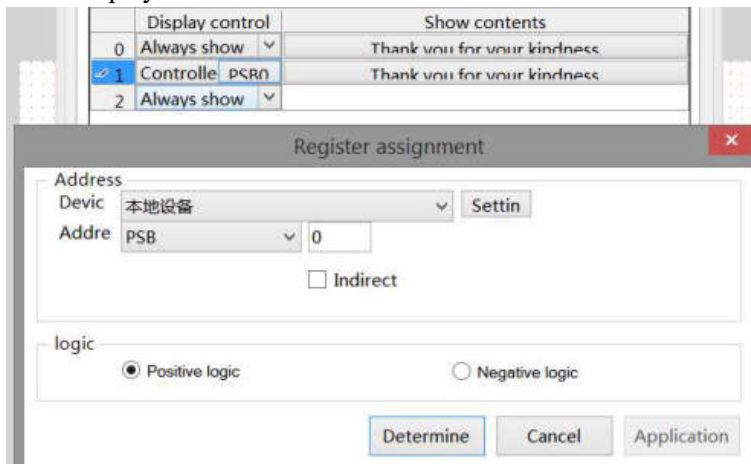

show contents Right click on the displayed content to copy it, create a new text string, create a new variable text, create a new data display, and delete the displayed content. Click/double-click on the displayed content to edit it again.

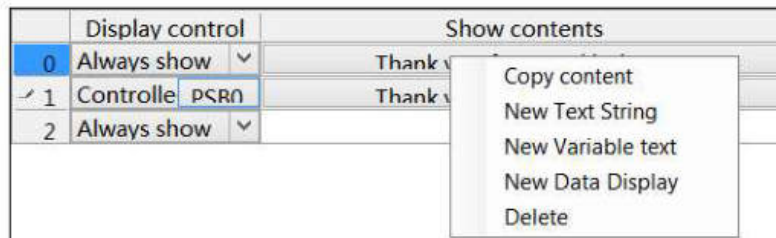

operate item Can add, delete, move up, and down display controls and content

font Can change the font, color, size of scrolling text, and set whether scrolling text is bold or italic

scroll	message space	Set the distance interval between each displayed content, in pixels
	scroll speed	Set the text scrolling speed to a few pixels per 0.1s (100ms), meaning that the larger the value, the faster the scrolling speed

border Set whether to display borders, as well as the thickness, style, and color of the borders

fill Set whether the background of scrolling text is filled and the fill color



The use of text string refers to the use of static text string in chapter 4-2-1.

The use of variable text refers to the use of dynamic text in chapter 4-2-2.

The use of data display refers to the use of data display in chapter 4-2-4.

Security setting

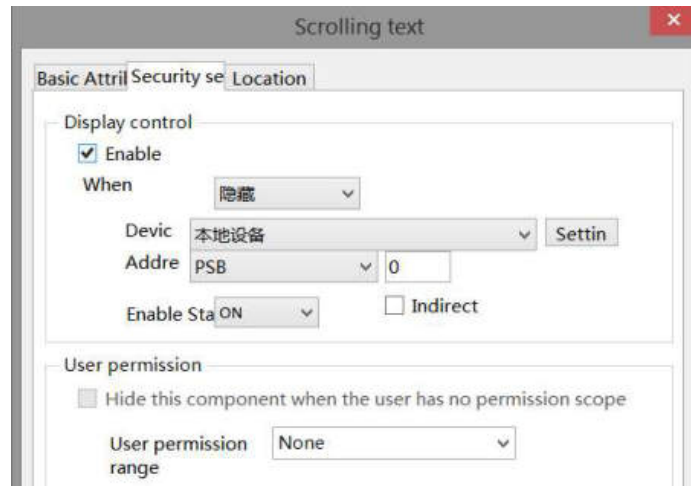

Same to chapter 4-1-1 straight line security setting part.

■ Location

Same to chapter 4-1-1 straight line location part.

4-9-3. Camera

TS5 series HMI support for connecting cameras and playing monitoring images:

1. Click on the "Parts/Multimedia" menu bar or the "Camera Play"  icon in the special parts bar of the control window, move the cursor to the screen, click the left mouse button to place, click the right mouse button or use the ESC key to cancel the placement. Modify the border length and width by dragging boundary points.
2. When setting attributes, you can set them in the attribute box that pops up when placing components, or double-click "Camera Play" or select "Camera Play" and right-click to select "Properties" for attribute settings.

■ Basic property

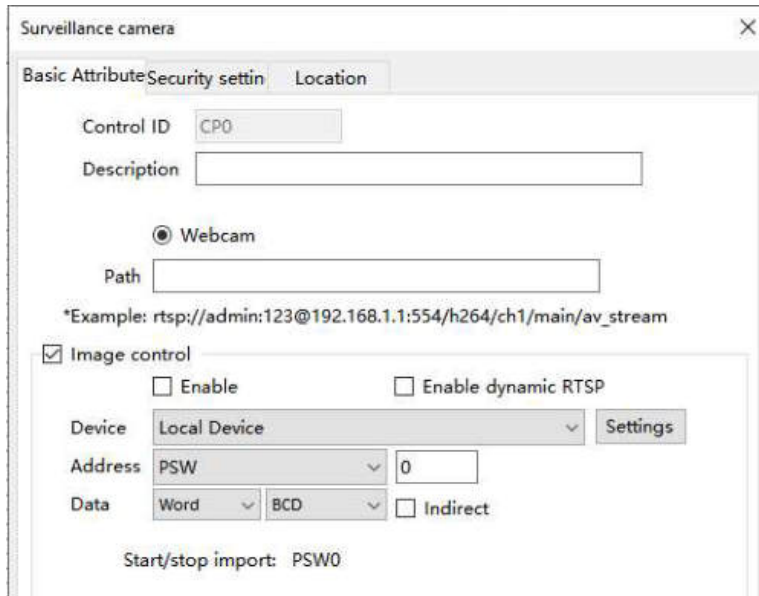

Control ID	Used for system management controls, user cannot operate.
Description	Can be used to annotate the purpose of this control.
Webcam	The default is checked and cannot be cancelled. Currently, only network cameras are supported.
Path	<p>Set the RTSP address for the network camera.</p> <p>Example of address format: rtsp://admin:123@192.168.1.1:554/h264/ch1/main/av stream, detailed as follows:</p> <p>Rtsp://- Address prefix, fixed format, can be uppercase or lowercase</p> <p>Admin - Connect the camera username, default to admin</p> <p>:- User name and password connectors</p> <p>123- Password for connecting the camera, default to verification code</p> <p>192.168.1.1- IP address of the camera</p> <p>:554- Camera RTSP address port number, default to 554</p> <p>h264- Encoding type of camera, only supports h264</p> <p>ch1- Channel number of the camera</p> <p>main - The stream type of the camera; Main: Main code stream; Sub: Auxiliary code stream</p> <p>Av_ Stream - Fixed Format</p>
Image control	<p>The playback control of the monitoring screen only has start/stop signals by default, and the address can be set below, with PSW0 as the default. PSW0=0 stops playing, PSW0=1 starts playing. When stopping playback, the camera playback control area is displayed as blank.</p> <p>You can select Enable pause and Enable Dynamic RTSP according to your usage needs.</p>
Enable pause	<p>If you need to add a pause signal, you can check this option. After checking it, use the image address+1 as the address to enable pause control. If PSW1=1, pause playback, and PSW1=0 resumes playback.</p>

Enable dynamic RTSP

Set whether to dynamically specify RTSP addresses

Image control

Enable Enable dynamic RTSP

Device: Local Device

Address: PSW 0

Data: Word BCD Indirect

Start/stop import: PSW0
Pause: PSW1
RTSP: PSW2 (64Word)

After checking, use the image address+2 as the RTSP header address, occupying a total of 64 words.



The RTSP addresses of different brands of cameras may vary. Please refer to the instructions provided by the camera manufacturer for accuracy.

1. User name, password

The default username for the camera factory is admin, and the password is a verification code, which can be viewed through the camera body label.



2. IP address

Open the Ezviz Cloud Studio software, click on [Device Management] in the bottom left corner, find the camera you want to view, and click on [Network Parameter Configuration] to view the camera IP address.

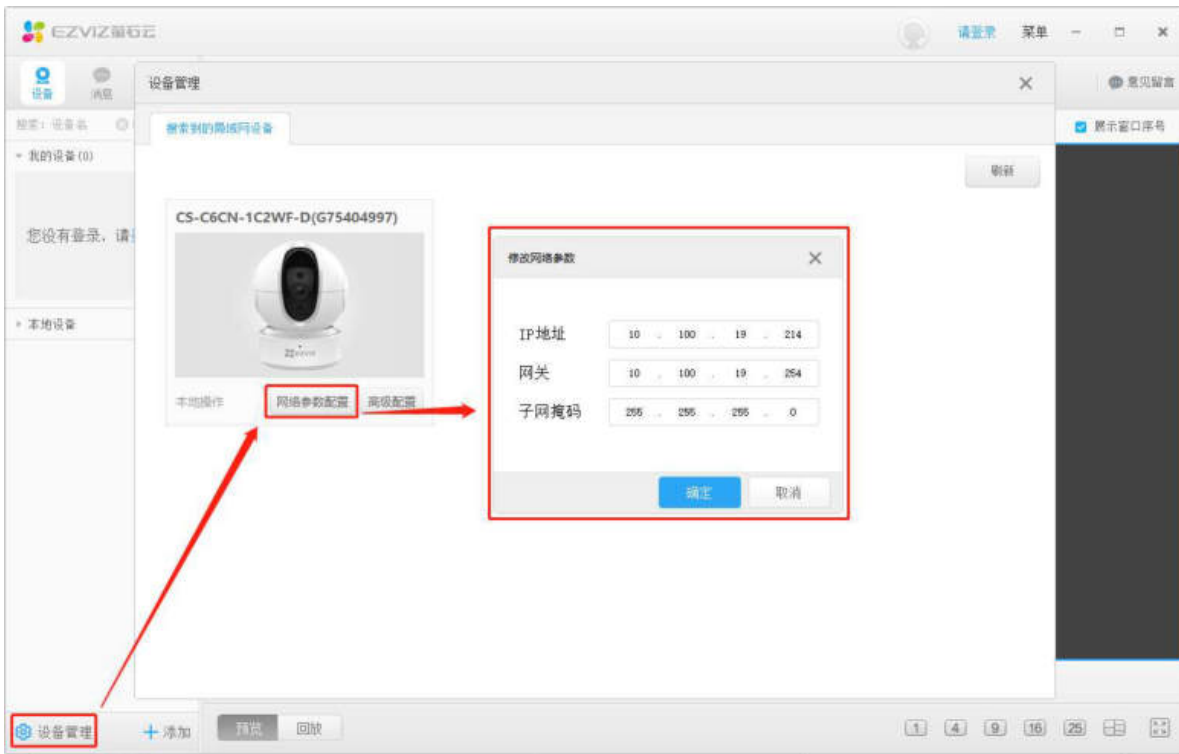

3. RTSP port

Open the Ezviz Cloud Studio software, click on [Device Management] in the bottom left corner, find the camera you want to view, click on [Advanced Configuration], and in [Network] - [Common], you can view the camera's RTSP address and port number.



4. Channel, stream type, and encoding type (please refer to this diagram for setting up the Ezviz cloud)

Still following the advanced configuration path from the previous step, switch to Image Video Audio to view the camera's channel, stream type, resolution, video frame rate, and encoding type.



5. Based on all the configuration information, it can be concluded that the RTSP address of the Ezviz camera used in this example is `rtsp://admin:KPEBID@10.100.19.214:554/h264/ch1/main/av` stream. You can directly input this address into the camera playback control for monitoring.

■ Security setting

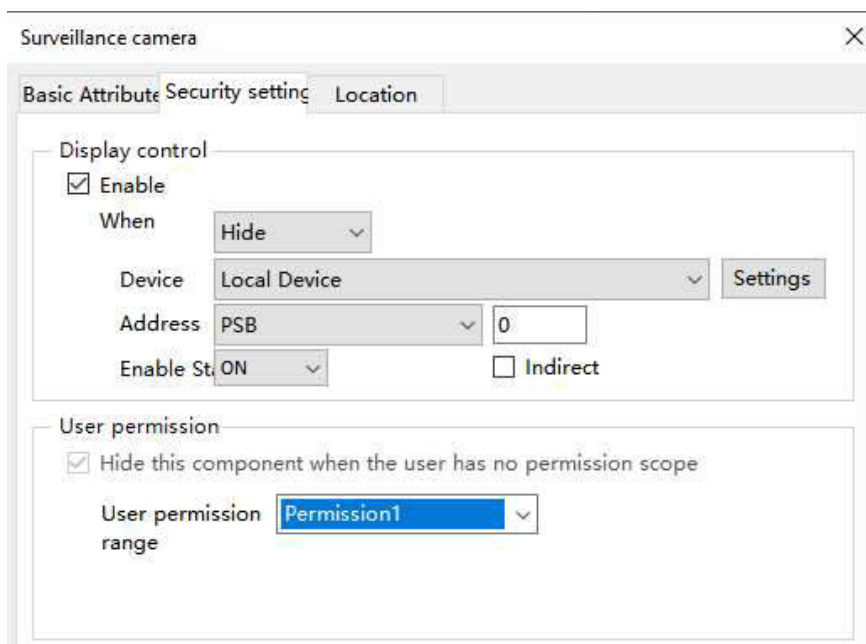

Same as chapter 4-1-1. Straight line safety setting section.

■ Location

Same as chapter 4-1-1. Straight line location part.

5. Library description

5-1. Label multilingual

5-1-1. Label multilingual introduction

When the text content of a component requires the display of multiple languages, programmers can establish the content of a multilingual tag library according to actual needs, and support the display of text in 8 different languages simultaneously.

In addition to using a multilingual tag library, it is also necessary to cooperate with the use of the system address "multilingual switching". The effective setting range for "multilingual switching" is 0-7, and different data corresponds to the desired language type to be displayed. The following is an example of using indicator buttons to illustrate how to use multiple languages.

When multiple languages need to be used in engineering documents, it is necessary to first establish a multilingual table and then select the desired label from it. Double click on the project tree library - label - multi language icon to enter the following interface.

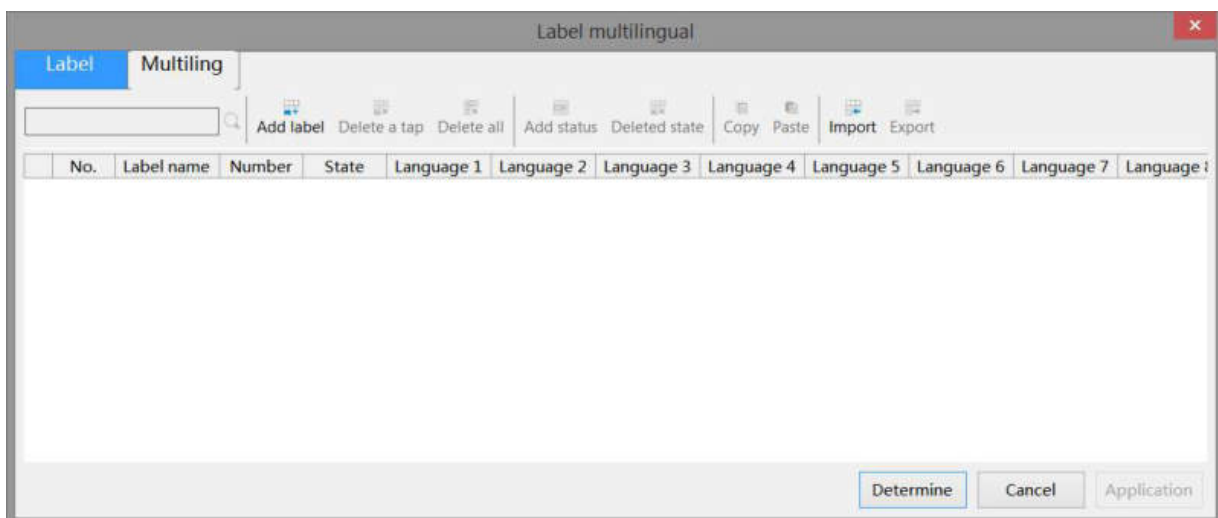
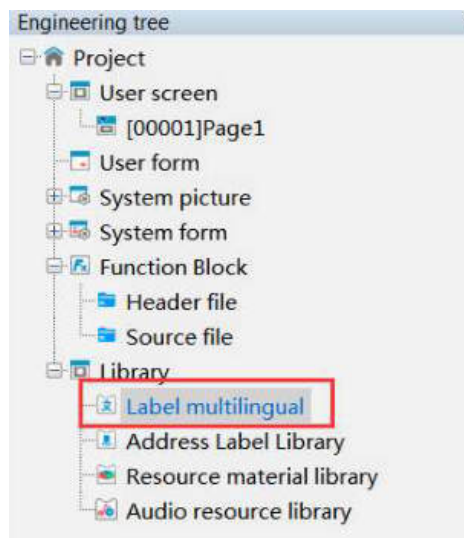

Label multilingualism is divided into label libraries and multilingual tables. Label libraries are suitable for multi-state components, such as indicator lights that turn on or off two states, indicator buttons, buttons, or

multi-state indicator lights for multiple states, multi-state buttons, etc. Multilingual tables are suitable for components with only a single state, such as static text, dynamic text, data tables, etc.

5-1-2. Label library

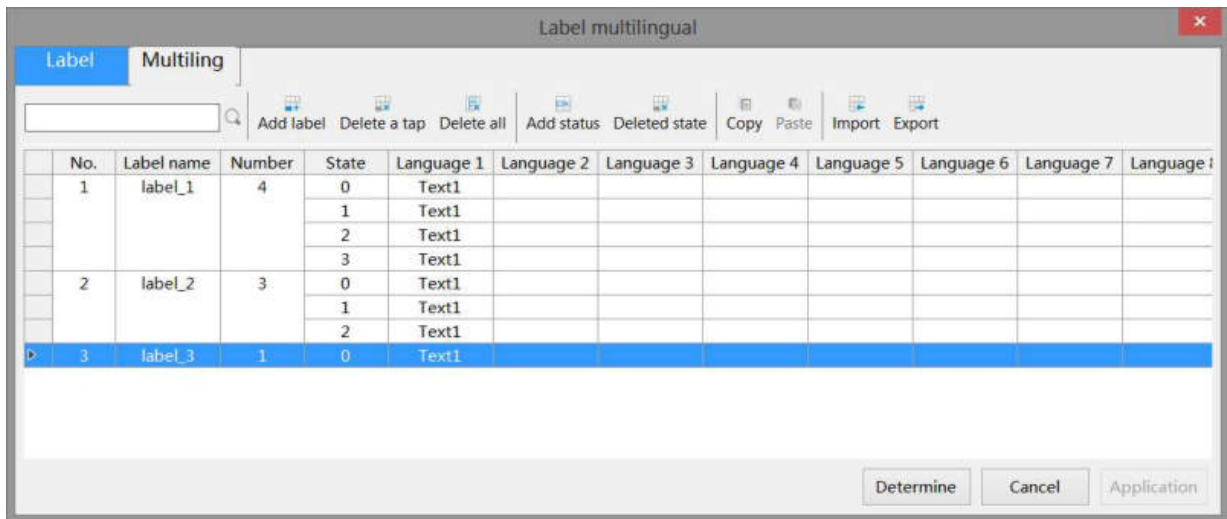

search	Search for the set language and quickly locate the line
add label	add a label
delete label	Delete selected labels
delete all	Delete all labels
add status	Add a state to a certain label (for example, the indicator light has two states, state 0 and state 1. Here, two states need to be added, and the text of the set state corresponds to each other)
delete status	Delete selected status
copy	Copy the selected row
paste	Paste a copied line
import	Import Label Library Table
export	Export Label Library Table

Operation steps

- (1) Click to add a label to define the name, quantity, status, and related language of the text label (click on the drop-down list after the status to set the text content in different states).

Label name: label_1
 Status: 2
 Quantity: 2
 State: 0
 Language 1: OFF
 Language 2: off
 Language 3:
 Language 4:
 Language 5:
 Language 6:
 Language 7:
 Language 8:
 Confirm

status 0 setting

Label name: label_1
 Status: 2
 Quantity: 2
 State: 1
 Language 1: ON
 Language 2: on
 Language 3:
 Language 4:
 Language 5:
 Language 6:
 Language 7:
 Language 8:
 Confirm

status 1 setting

- (2) After clicking OK, it will be displayed in the table and can be modified directly in the table. (Double click to bring up the settings bar in the first step, and click below the language to directly modify the text)

No.	Label name	Number	State	Language 1	Language 2	Language 3	Language 4	Language 5	Language 6	Language 7	Language 8
1	label_1	2	0	OFF	off						
			1	ON	on						

Determine Cancel Application

- (3) click determine to save the settings.

5-1-3. Label table

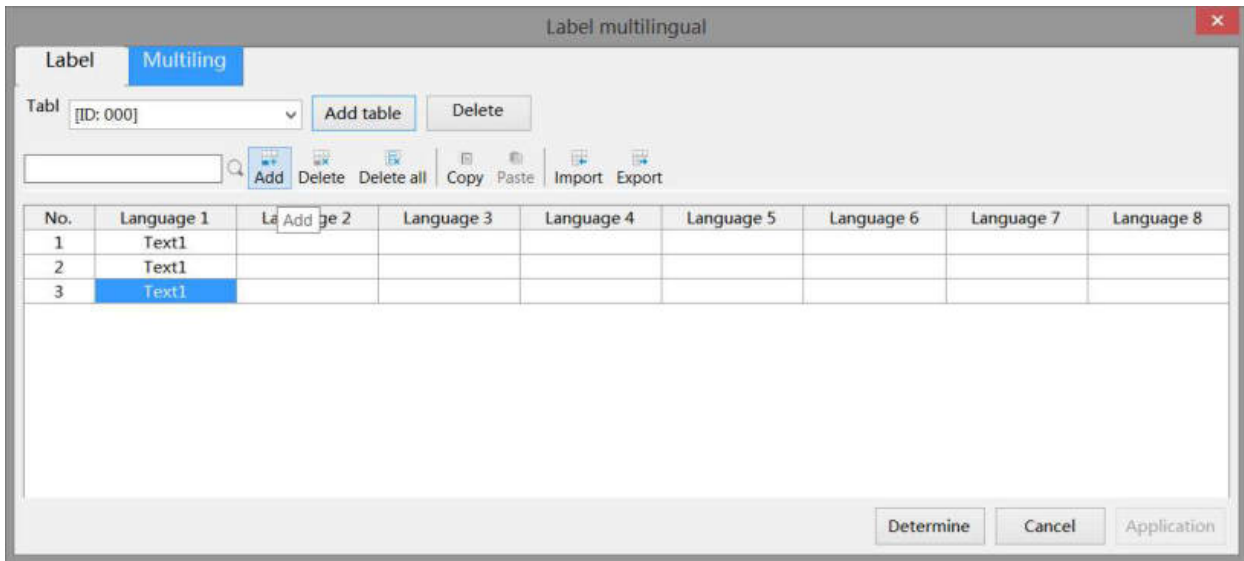

add table	Add a multilingual table
delete	delete the table
search	Search for the set language and quickly locate the line
add	Add a number to the selected table
delete	Delete numbers in the selected table
delete all	Delete all numbers
copy	Copy the row containing the selected number
paste	Paste a copied line
import	Import Multilingual Table
export	Export Multilingual Table

Operation steps:

- (1) Click to add a table, and the added table will be displayed in the screen, as shown in the following figure. (You can select the table you want to set from the drop-down list after the 'Table')

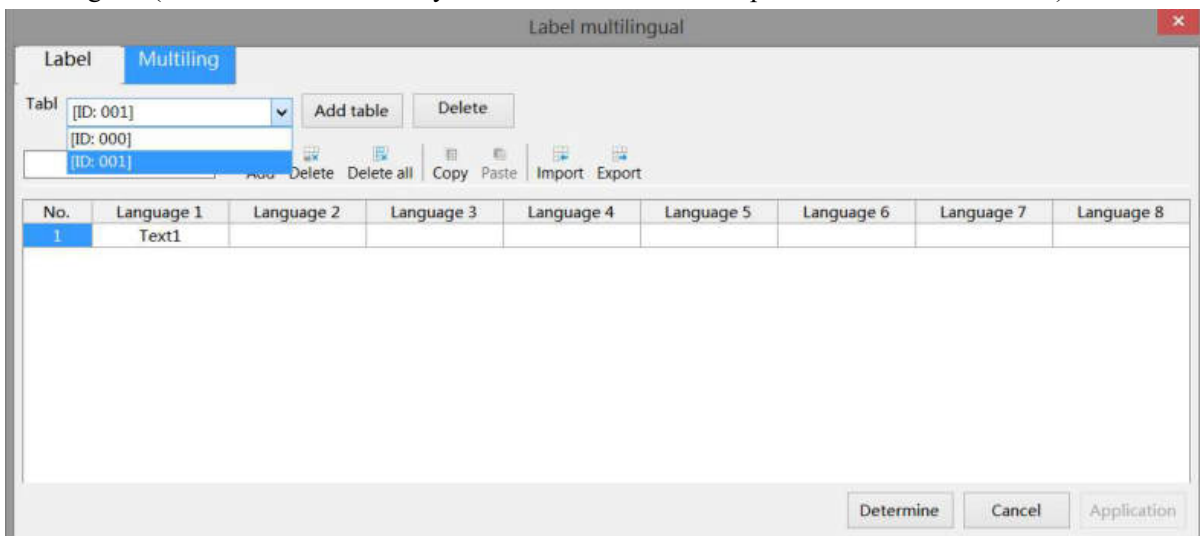

- (2) Click on options such as add/delete and click under Language to directly set text.

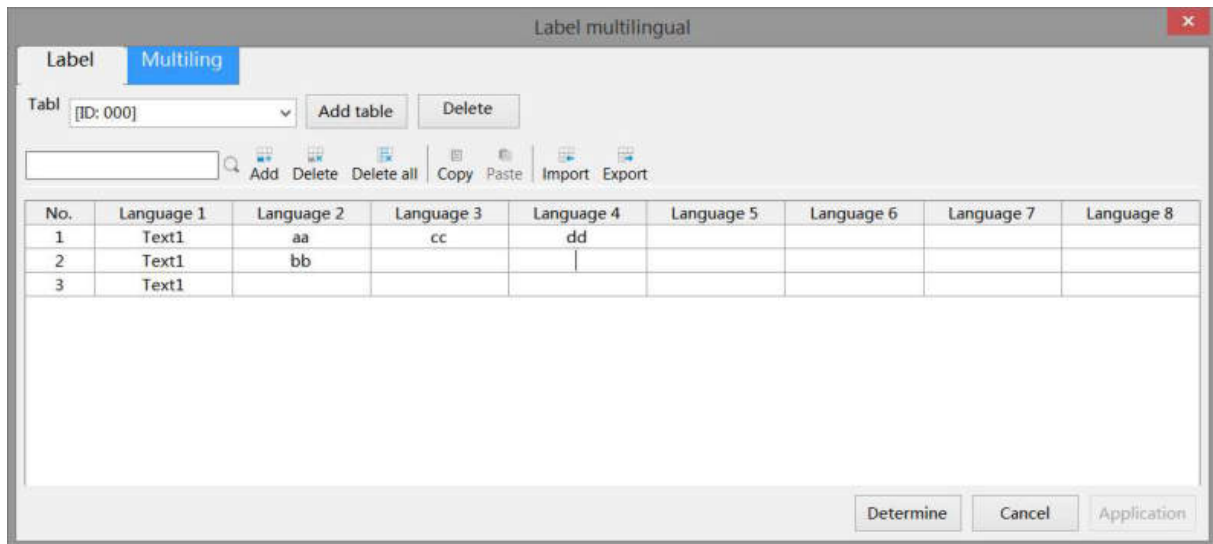

(3) click determine to save the setting.

5-1-4. Examples of Multilingual Usage of Labels

1. Example of using label library (indicator light)

In the "Appearance" tab of the indicator light, follow the operating steps as shown in the figure to set it. You can click on the "Edit" font to directly jump to the label multilingual setting interface. (For the "indicator light [2]" in the fourth step, refer to the operating steps of the label library mentioned earlier.)

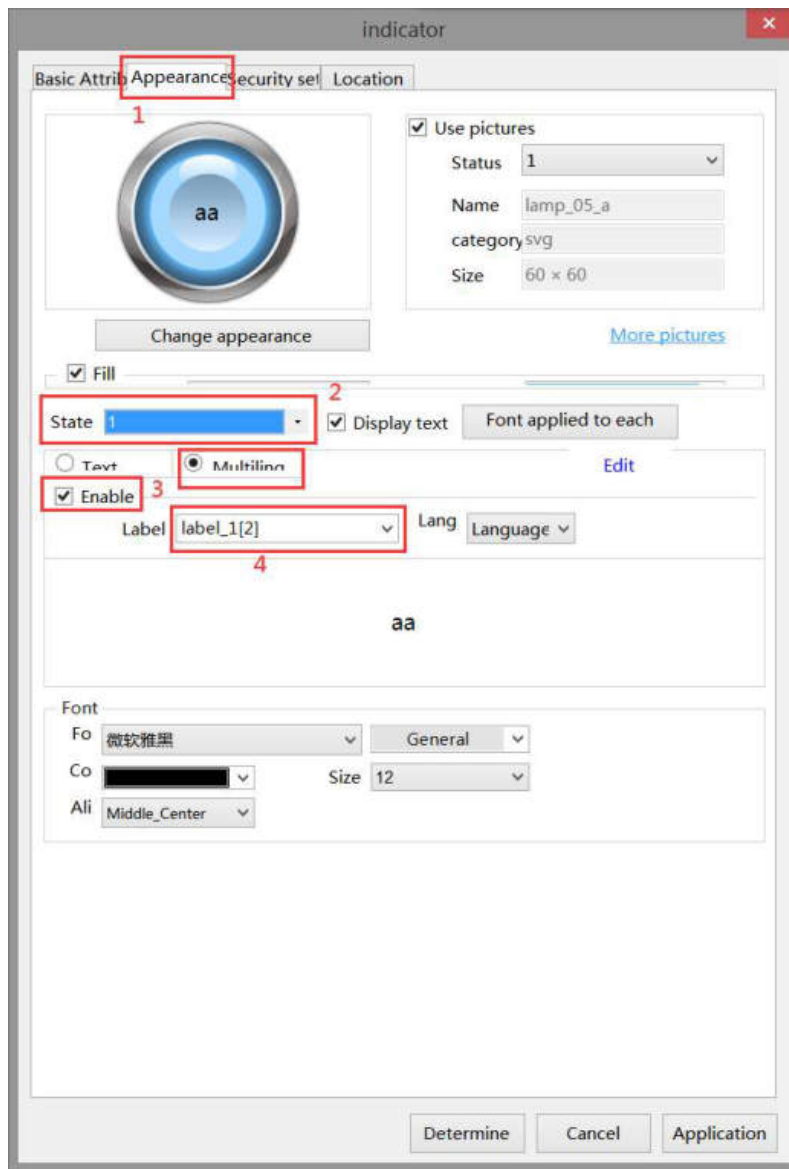

As shown in the following figure, select multiple languages from the drop-down list after "L" (downloaded to the HMI, you can switch between multiple languages by using the values in the system register SPFW260. The input value range 0-7 corresponds to the set language 1 to language 8, and if the input value is not 0-7, language 1 will be displayed).

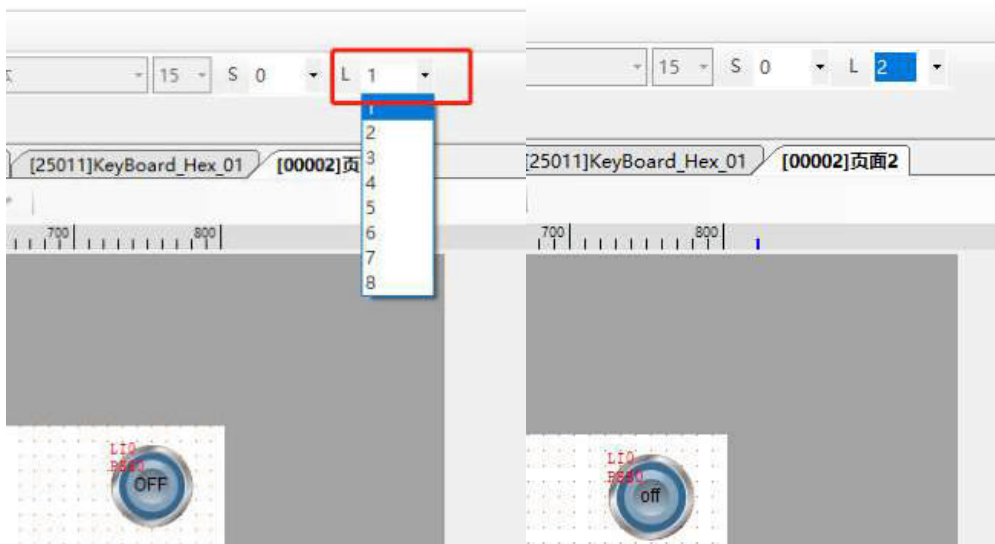

2. Example of using multiple language library (static text/dynamic text string)

In the "Basic attributes" tab of static text, follow the operating steps as shown in the figure to set it. You can click "Edit" font to directly jump to the label multilingual setting interface. (For the "ID: 004" in the fourth step, refer to the operating steps of a multilingual library)

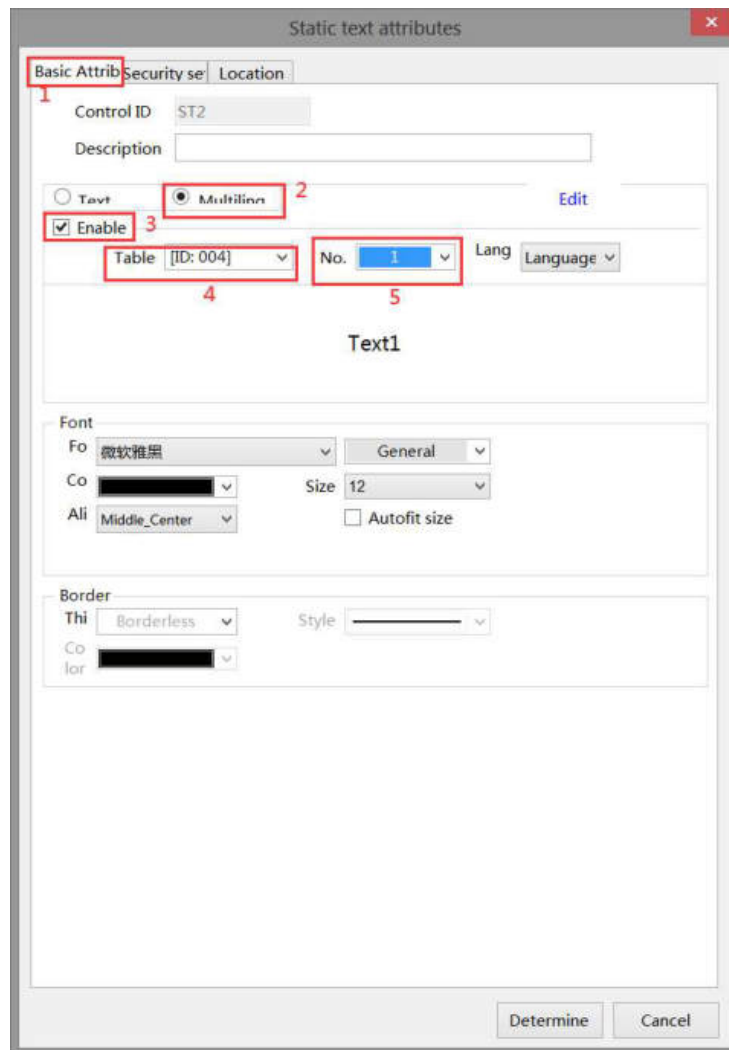

In the "Display" tab of the dynamic text string, follow the operating steps as shown in the figure to set it. You can click "..." in the second step to directly jump to the label multilingual setting interface. (For the third and fourth steps, please refer to the operating steps of multilingual library)

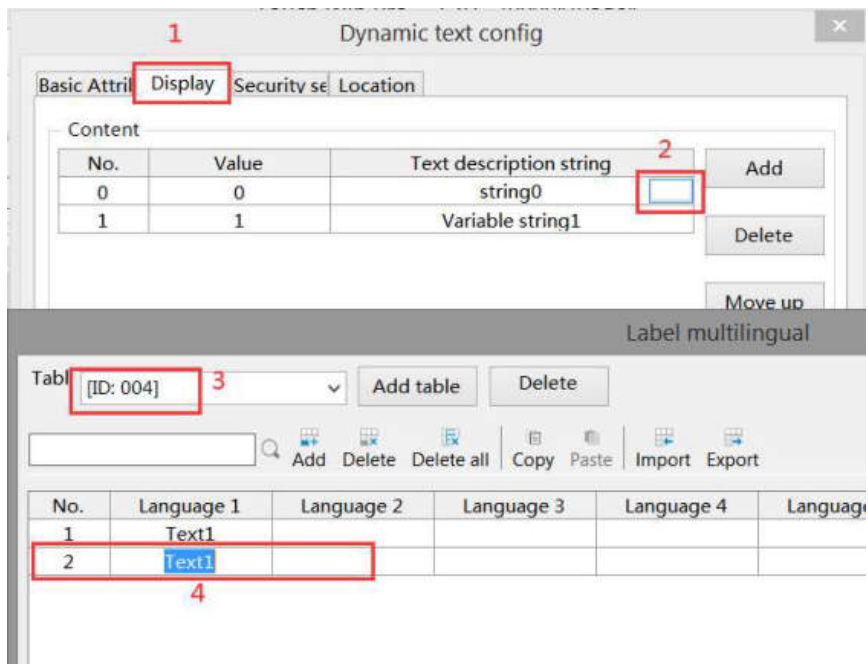

As shown in the following figure, select multiple languages from the drop-down list after "L". (Downloading to the HMI, multilingual switching through the values in the system register SPFW260. The input value range 0-7 corresponds to the set language 1 to language 8, respectively. If the input value is not 0-7, language 1 will be displayed.)

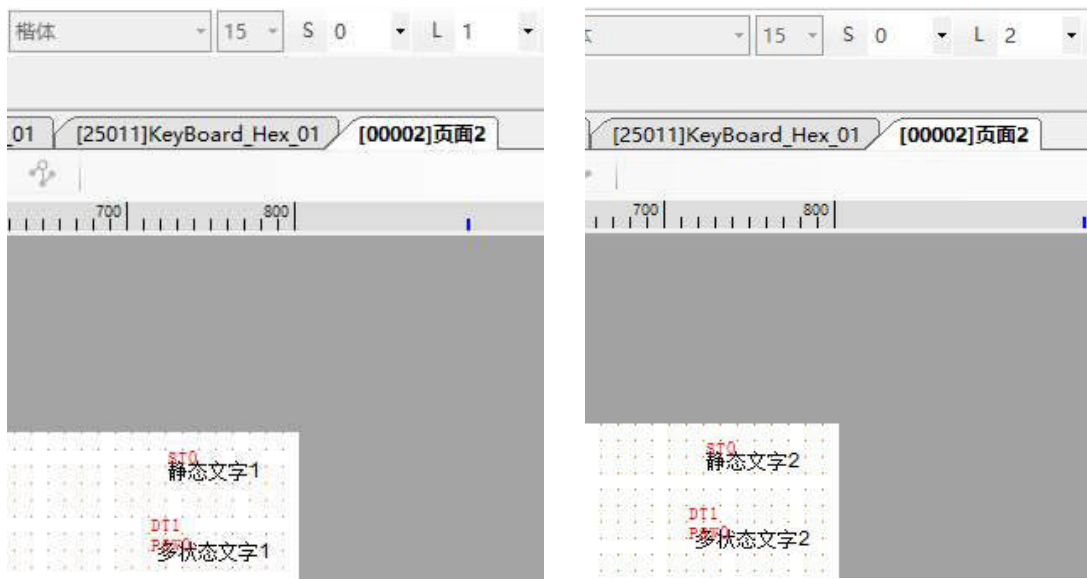

language 1

language 2

5-2. Address label library

5-2-1. HMI internal address

The TS series HMI has six types of internal objects: PSB, PSW, PFW, SPSB, SPSW, and SPFW.

Object type	Note
PSB	Bit object
PSW	Non power outage maintenance word object
PFW	Power outage maintenance word object
SPSB	The system used bit addresses, which belong to special addresses. For detailed meanings, please refer to chapter 5-2-2
SPSW	The system's non power outage maintenance word address belongs to a special address, and its detailed meaning can be found in chapter 5-2-2
SPFW	The system's power outage maintenance word address belongs to a special address, and its detailed meaning can be found in chapter 5-2-2

The scope of internal objects that can be used by each model:

	TS2 series	TS3/TS5/TS5D series
PSB	0~10000	
PSW	0~10000	
PFW	0~1000000	0~3000000

The number and range of PFW data can be modified through "File/System Settings/Monitor/Parameter", and the number of PFW generally does not need to be modified; The range of initial values set in the file PFW data is greater than the number of PFWs or during configuration operation, and the number of PFWs can be modified to not be less than the number of PFWs used in the program.

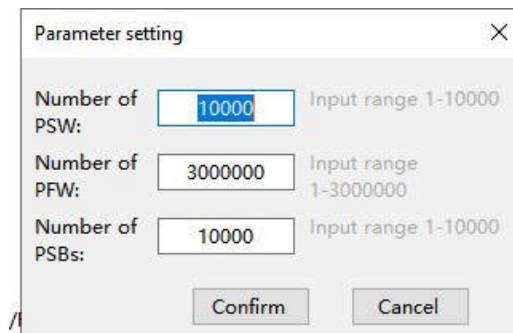

5-2-2. System label

Used to display HMI system address information, making it easy for users to view and use.

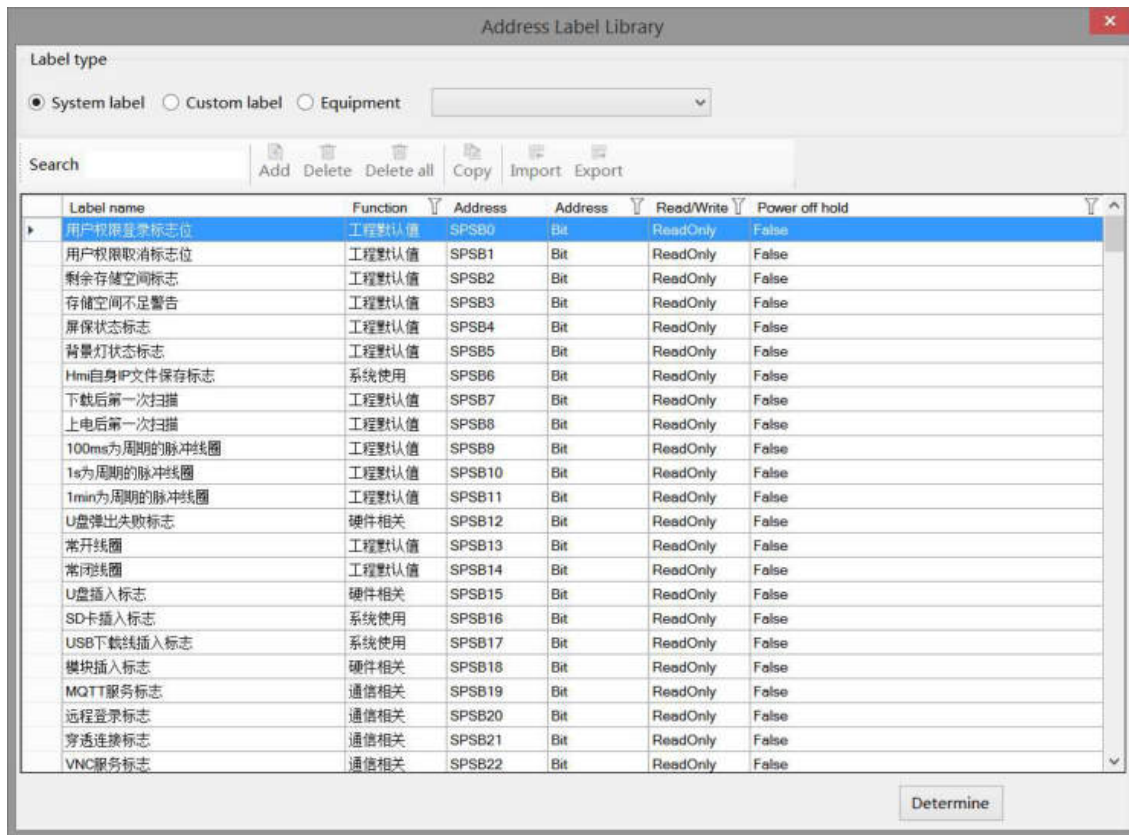

You can search in the search area and click  to quickly query the required registers (system registers cannot be changed).

type	label name	device name	station no.	address type	address	data type	read write mode	power-off holding
HMI related	User permission login flag bit	Local device	0	SPSB	0	Bit	ReadOnly	False
	User permission cancellation flag bit	Local device	0	SPSB	1	Bit	ReadOnly	False
	Remaining storage space	Local device	0	SPSB	2	Bit	ReadOnly	False
	Insufficient storage space warning	Local device	0	SPSB	3	Bit	ReadOnly	False
	Screen saver status flag	Local device	0	SPSB	4	Bit	ReadOnly	False
	Backlight control	Local device	0	SPSB	5	Bit	ReadOnly	False
	First scan after download	Local device	0	SPSB	7	Bit	ReadOnly	False
	First scan after power on	Local device	0	SPSB	8	Bit	ReadOnly	False

type	label name	device name	station no.	address type	address	data type	read write mode	power-off holding
		device						
	Pulse coil with a period of 100ms	Local device	0	SPSB	9	Bit	ReadOnly	False
	Pulse coil with a period of 1 second	Local device	0	SPSB	10	Bit	ReadOnly	False
	Pulse coil with a period of 1 minute	Local device	0	SPSB	11	Bit	ReadOnly	False
	normally open coil	Local device	0	SPSB	13	Bit	ReadOnly	False
	normally close coil	Local device	0	SPSB	14	Bit	ReadOnly	False
	Clear alarm records	Local device	0	SPSB	120	Bit	R/W	False
	HMI ID	Local device	0	SPSW	0	String	ReadOnly	False
	Year -Decimal	Local device	0	SPSW	16	Word	ReadOnly	False
	Month -Decimal	Local device	0	SPSW	17	Word	ReadOnly	False
	Day -Decimal	Local device	0	SPSW	18	Word	ReadOnly	False
	Hour -Decimal	Local device	0	SPSW	19	Word	ReadOnly	False
	Minute -Decimal	Local device	0	SPSW	20	Word	ReadOnly	False
	Second -Decimal	Local device	0	SPSW	21	Word	ReadOnly	False
	Week -Decimal	Local device	0	SPSW	22	Word	ReadOnly	False
	Year -Hex	Local device	0	SPSW	23	Word	ReadOnly	False
	Month - Hex	Local device	0	SPSW	24	Word	ReadOnly	False
	Day - Hex	Local device	0	SPSW	25	Word	ReadOnly	False
	Hour - Hex	Local device	0	SPSW	26	Word	ReadOnly	False
	Minute - Hex	Local device	0	SPSW	27	Word	ReadOnly	False
	Second - Hex	Local device	0	SPSW	28	Word	ReadOnly	False
	Week - Hex	Local device	0	SPSW	29	Word	ReadOnly	False

type	label name	device name	station no.	address type	address	data type	read write mode	power-off holding
	Current screen number	Local device	0	SPSW	30	Word	ReadOnly	False
	System running time	Local device	0	SPSW	31	DWord	ReadOnly	False
	HMI software version	Local device	0	SPSW	90	String	ReadOnly	False
	System runtime - hour	Local device	0	SPSW	200	Word	ReadOnly	False
	System runtime - minute	Local device	0	SPSW	201	Word	ReadOnly	False
	System runtime - second	Local device	0	SPSW	202	Word	ReadOnly	False
	HMI model	Local device	0	SPSW	209	Word	ReadOnly	False
	HmiMain version	Local device	0	SPSW	211	String	ReadOnly	False
	System version	Local device	0	SPSW	221	String	ReadOnly	False
	Memory footprint	Local device	0	SPSW	231	DWord	ReadOnly	False
	Memory total capacity	Local device	0	SPSW	233	DWord	ReadOnly	False
	Storage occupancy	Local device	0	SPSW	235	DWord	ReadOnly	False
	Total storage capacity	Local device	0	SPSW	237	DWord	ReadOnly	False
	Backlight adjustment (values 0-11)	Local device	0	SPFW	252	Word	R/W	True
	Recipe Index	Local device	0	SPFW	256	Word	R/W	True
	Start screen number	Local device	0	SPFW	257	Word	R/W	True
	Screensaver time	Local device	0	SPFW	258	Word	R/W	True
	Multi language switching	Local device	0	SPFW	260	Word	R/W	True
	Turn off the buzzer	Local device	0	SPFW	448	Bit	R/W	True
	hide cursor	Local device	0	SPFW	449	Bit	R/W	True
	Hide System Menu	Local device	0	SPFW	450	Bit	R/W	True
	Turn off backlight	Local	0	SPFW	452	Bit	R/W	True

type	label name	device name	station no.	address type	address	data type	read write mode	power-off holding
		device						
Hardware	Flash disk eject failure flag	Local device	0	SPSB	12	Bit	ReadOnly	False
	Flash disk insertion flag	Local device	0	SPSB	15	Bit	ReadOnly	False
	Module insertion flag	Local device	0	SPSB	18	Bit	ReadOnly	False
	Clear alarm records	Local device	0	SPSB	120	Bit	R/W	False
	restart	Local device	0	SPSB	200	Bit	WriteOnly	False
	Safely ejecting the flash disk	Local device	0	SPSB	201	Bit	WriteOnly	False
	HMI hardware version	Local device	0	SPSW	33	String	ReadOnly	False
Communication	MQTT service flag	Local device	0	SPSB	19	Bit	ReadOnly	False
	Remote login flag	Local device	0	SPSB	20	Bit	ReadOnly	False
	passthrough connection flag	Local device	0	SPSB	21	Bit	ReadOnly	False
	VNC service flag	Local device	0	SPSB	22	Bit	ReadOnly	False
	Informationization LAN Connection Flag	Local device	0	SPSB	23	Bit	ReadOnly	False
	Communication failure flag	Local device	0	SPSB	48	Bit	ReadOnly	False
	Communication failure flag for communication port 1	Local device	0	SPSB	49	Bit	ReadOnly	False
	Communication failure flag for communication port 2	Local device	0	SPSB	50	Bit	ReadOnly	False
	Communication failure flag for communication port 3	Local device	0	SPSB	51	Bit	ReadOnly	False
	Ethernet device communication failure flag	Local device	0	SPSB	52	Bit	ReadOnly	False
	Number of devices	Local device	0	SPSW	43	Word	ReadOnly	True
	port 1 communication successful times	Local device	0	SPSW	44	Word	ReadOnly	False
	port 1 communication error times	Local device	0	SPSW	45	Word	ReadOnly	False
	port 1 communication timeout times	Local device	0	SPSW	46	Word	ReadOnly	False

type	label name	device name	station no.	address type	address	data type	read write mode	power-off holding
	port 1 communication failure times	Local device	0	SPSW	47	Word	ReadOnly	False
	port 2 communication successful times	Local device	0	SPSW	48	Word	ReadOnly	False
	port 2 communication error times	Local device	0	SPSW	49	Word	ReadOnly	False
	port 2 communication timeout times	Local device	0	SPSW	50	Word	ReadOnly	False
	port 2 communication failure times	Local device	0	SPSW	51	Word	ReadOnly	False
	port 3 communication successful times	Local device	0	SPSW	52	Word	ReadOnly	False
	port 3 communication error times	Local device	0	SPSW	53	Word	ReadOnly	False
	port 3 communication timeout times	Local device	0	SPSW	54	Word	ReadOnly	False
	port 3 communication failure times	Local device	0	SPSW	55	Word	ReadOnly	False
	present connection method	Local device	0	SPSW	56	Word	ReadOnly	False
	present connection signal strength	Local device	0	SPSW	57	Word	ReadOnly	False
	Informatization IP address	Local device	0	SPSW	58	Word	ReadOnly	False
	Informatization subnet mask	Local device	0	SPSW	62	Word	ReadOnly	False
	Informatization default gateway	Local device	0	SPSW	66	Word	ReadOnly	False
	Informatization port no.	Local device	0	SPSW	70	Word	ReadOnly	False
	Informatization DNS server	Local device	0	SPSW	71	Word	ReadOnly	False
	Informatization MAC address	Local device	0	SPSW	75	Word	ReadOnly	False
	Informatization module information	Local device	0	SPSW	81	Word	ReadOnly	False
	COM1 communication response code	Local device	0	SPSW	203	DWord	ReadOnly	False
	COM2 communication response code	Local device	0	SPSW	205	DWord	ReadOnly	False
	COM3 communication response code	Local device	0	SPSW	207	DWord	ReadOnly	False
	Ethernet device 1 IP	Local	0	SPFW	1	Word	R/W	True

type	label name	device name	station no.	address type	address	data type	read write mode	power-off holding
	address	device						
	Ethernet device 1 port no.	Local device	0	SPFW	5	Word	R/W	True
	Ethernet device 2 IP address	Local device	0	SPFW	6	Word	R/W	True
	Ethernet device 2 port no.	Local device	0	SPFW	10	Word	R/W	True
	Ethernet device 3 IP address	Local device	0	SPFW	11	Word	R/W	True
	Ethernet device 3 port no.	Local device	0	SPFW	15	Word	R/W	True
	Ethernet device 4 IP address	Local device	0	SPFW	16	Word	R/W	True
	Ethernet device 4 port no.	Local device	0	SPFW	20	Word	R/W	True
	Ethernet device 5 IP address	Local device	0	SPFW	21	Word	R/W	True
	Ethernet device 5 port no.	Local device	0	SPFW	25	Word	R/W	True
	Ethernet device 6 IP address	Local device	0	SPFW	26	Word	R/W	True
	Ethernet device 6 port no.	Local device	0	SPFW	30	Word	R/W	True
	Ethernet device 7 IP address	Local device	0	SPFW	31	Word	R/W	True
	Ethernet device 7 port no.	Local device	0	SPFW	35	Word	R/W	True
	Ethernet device 8 IP address	Local device	0	SPFW	36	Word	R/W	True
	Ethernet device 8 port no.	Local device	0	SPFW	40	Word	R/W	True
	Ethernet device 9 IP address	Local device	0	SPFW	41	Word	R/W	True
	Ethernet device 9 port no.	Local device	0	SPFW	45	Word	R/W	True
	Ethernet device 10 IP address	Local device	0	SPFW	46	Word	R/W	True
	Ethernet device 10 port no.	Local device	0	SPFW	50	Word	R/W	True
	Ethernet device 11 IP address	Local device	0	SPFW	51	Word	R/W	True
	Ethernet device 11 port no.	Local device	0	SPFW	55	Word	R/W	True

type	label name	device name	station no.	address type	address	data type	read write mode	power-off holding
	Ethernet device 12 IP address	Local device	0	SPFW	56	Word	R/W	True
	Ethernet device 12 port no.	Local device	0	SPFW	60	Word	R/W	True
	Ethernet device 13 IP address	Local device	0	SPFW	61	Word	R/W	True
	Ethernet device 13 port no.	Local device	0	SPFW	65	Word	R/W	True
	Ethernet device 14 IP address	Local device	0	SPFW	66	Word	R/W	True
	Ethernet device 14 port no.	Local device	0	SPFW	70	Word	R/W	True
	Ethernet device 15 IP address	Local device	0	SPFW	71	Word	R/W	True
	Ethernet device 15 port no.	Local device	0	SPFW	75	Word	R/W	True
	Ethernet device 16 IP address	Local device	0	SPFW	76	Word	R/W	True
	Ethernet device 16 port no.	Local device	0	SPFW	80	Word	R/W	True
	Ethernet device 17 IP address	Local device	0	SPFW	81	Word	R/W	True
	Ethernet device 17 port no.	Local device	0	SPFW	85	Word	R/W	True
	Ethernet device 18 IP address	Local device	0	SPFW	86	Word	R/W	True
	Ethernet device 18 port no.	Local device	0	SPFW	90	Word	R/W	True
	Ethernet device 19 IP address	Local device	0	SPFW	91	Word	R/W	True
	Ethernet device 19 port no.	Local device	0	SPFW	95	Word	R/W	True
	Ethernet device 20 IP address	Local device	0	SPFW	96	Word	R/W	True
	Ethernet device 20 port no.	Local device	0	SPFW	100	Word	R/W	True
	Ethernet device 21 IP address	Local device	0	SPFW	101	Word	R/W	True
	Ethernet device 21 port no.	Local device	0	SPFW	105	Word	R/W	True
	Ethernet device 22 IP address	Local device	0	SPFW	106	Word	R/W	True
	Ethernet device 22 port no.	Local	0	SPFW	110	Word	R/W	True

type	label name	device name	station no.	address type	address	data type	read write mode	power-off holding
		device						
	Ethernet device 23 IP address	Local device	0	SPFW	111	Word	R/W	True
	Ethernet device 23 port no.	Local device	0	SPFW	115	Word	R/W	True
	Ethernet device 24 IP address	Local device	0	SPFW	116	Word	R/W	True
	Ethernet device 24 port no.	Local device	0	SPFW	120	Word	R/W	True
	Ethernet device 25 IP address	Local device	0	SPFW	121	Word	R/W	True
	Ethernet device 25 port no.	Local device	0	SPFW	125	Word	R/W	True
	Ethernet device 26 IP address	Local device	0	SPFW	126	Word	R/W	True
	Ethernet device 26 port no.	Local device	0	SPFW	130	Word	R/W	True
	Ethernet device 27 IP address	Local device	0	SPFW	131	Word	R/W	True
	Ethernet device 27 port no.	Local device	0	SPFW	135	Word	R/W	True
	Ethernet device 28 IP address	Local device	0	SPFW	136	Word	R/W	True
	Ethernet device 28 port no.	Local device	0	SPFW	140	Word	R/W	True
	Ethernet device 29 IP address	Local device	0	SPFW	141	Word	R/W	True
	Ethernet device 29 port no.	Local device	0	SPFW	145	Word	R/W	True
	Ethernet device 30 IP address	Local device	0	SPFW	146	Word	R/W	True
	Ethernet device 30 port no.	Local device	0	SPFW	150	Word	R/W	True
	Ethernet device 31 IP address	Local device	0	SPFW	151	Word	R/W	True
	Ethernet device 31 port no.	Local device	0	SPFW	155	Word	R/W	True
	Ethernet device 32 IP address	Local device	0	SPFW	156	Word	R/W	True
	Ethernet device 32 port no.	Local device	0	SPFW	160	Word	R/W	True
	Ethernet device 33 IP address	Local device	0	SPFW	161	Word	R/W	True

type	label name	device name	station no.	address type	address	data type	read write mode	power-off holding
	Ethernet device 33 port no.	Local device	0	SPFW	165	Word	R/W	True
	Ethernet device 34 IP address	Local device	0	SPFW	166	Word	R/W	True
	Ethernet device 34 port no.	Local device	0	SPFW	170	Word	R/W	True
	Ethernet device 35 IP address	Local device	0	SPFW	171	Word	R/W	True
	Ethernet device 35 port no.	Local device	0	SPFW	175	Word	R/W	True
	Ethernet device 36 IP address	Local device	0	SPFW	176	Word	R/W	True
	Ethernet device 36 port no.	Local device	0	SPFW	180	Word	R/W	True
	Ethernet device 37 IP address	Local device	0	SPFW	181	Word	R/W	True
	Ethernet device 37 port no.	Local device	0	SPFW	185	Word	R/W	True
	Ethernet device 38 IP address	Local device	0	SPFW	186	Word	R/W	True
	Ethernet device 38 port no.	Local device	0	SPFW	190	Word	R/W	True
	Ethernet device 39 IP address	Local device	0	SPFW	191	Word	R/W	True
	Ethernet device 39 port no.	Local device	0	SPFW	195	Word	R/W	True
	Ethernet device 40 IP address	Local device	0	SPFW	196	Word	R/W	True
	Ethernet device 40 port no.	Local device	0	SPFW	200	Word	R/W	True
	Ethernet device 41 IP address	Local device	0	SPFW	201	Word	R/W	True
	Ethernet device 41 port no.	Local device	0	SPFW	205	Word	R/W	True
	Ethernet device 42 IP address	Local device	0	SPFW	206	Word	R/W	True
	Ethernet device 42 port no.	Local device	0	SPFW	210	Word	R/W	True
	Ethernet device 43 IP address	Local device	0	SPFW	211	Word	R/W	True
	Ethernet device 43 port no.	Local device	0	SPFW	215	Word	R/W	True
	Ethernet device 44 IP	Local	0	SPFW	216	Word	R/W	True

type	label name	device name	station no.	address type	address	data type	read write mode	power-off holding
	address	device						
	Ethernet device 44 port no.	Local device	0	SPFW	220	Word	R/W	True
	Ethernet device 45 IP address	Local device	0	SPFW	221	Word	R/W	True
	Ethernet device 45 port no.	Local device	0	SPFW	225	Word	R/W	True
	Ethernet device 46 IP address	Local device	0	SPFW	226	Word	R/W	True
	Ethernet device 46 port no.	Local device	0	SPFW	230	Word	R/W	True
	Ethernet device 47 IP address	Local device	0	SPFW	231	Word	R/W	True
	Ethernet device 47 port no.	Local device	0	SPFW	235	Word	R/W	True
	Ethernet device 48 IP address	Local device	0	SPFW	236	Word	R/W	True
	Ethernet device 48 port no.	Local device	0	SPFW	240	Word	R/W	True
	Ethernet device 49 IP address	Local device	0	SPFW	241	Word	R/W	True
	Ethernet device 49 port no.	Local device	0	SPFW	245	Word	R/W	True
	Ethernet device 50 IP address	Local device	0	SPFW	246	Word	R/W	True
	Ethernet device 50 port no.	Local device	0	SPFW	250	Word	R/W	True
	HMI IP address	Local device	0	SPFW	318	Word	R/W	True
	HMI subnet	Local device	0	SPFW	322	Word	R/W	True
	HMI gateway	Local device	0	SPFW	326	Word	R/W	True
	HMI port no.	Local device	0	SPFW	330	Word	R/W	True
	HMI DNS server	Local device	0	SPFW	331	Word	R/W	True
	Communication port 1 interface type	Local device	0	SPFW	335	Word	R/W	True
	Communication port 1 device station no.	Local device	0	SPFW	336	Word	R/W	True
	Communication port 1 device baud rate	Local device	0	SPFW	337	Word	R/W	True

type	label name	device name	station no.	address type	address	data type	read write mode	power-off holding
	Communication port 1 device data bit	Local device	0	SPFW	338	Word	R/W	True
	Communication port 1 device stop bit	Local device	0	SPFW	339	Word	R/W	True
	Communication port 1 device parity bit	Local device	0	SPFW	340	Word	R/W	True
	Communication port 1 delay before sending	Local device	0	SPFW	341	Word	R/W	True
	Communication port 2 interface type	Local device	0	SPFW	343	Word	R/W	True
	Communication port 2 device station no.	Local device	0	SPFW	344	Word	R/W	True
	Communication port 2 device baud rate	Local device	0	SPFW	345	Word	R/W	True
	Communication port 2 device data bit	Local device	0	SPFW	346	Word	R/W	True
	Communication port 2 device stop bit	Local device	0	SPFW	347	Word	R/W	True
	Communication port 2 device parity bit	Local device	0	SPFW	348	Word	R/W	True
	Communication port 2 delay before sending	Local device	0	SPFW	349	Word	R/W	True
	Communication port 3 interface type	Local device	0	SPFW	351	Word	R/W	True
	Communication port 3 device station no.	Local device	0	SPFW	352	Word	R/W	True
	Communication port 3 device baud rate	Local device	0	SPFW	353	Word	R/W	True
	Communication port 3 device data bit	Local device	0	SPFW	354	Word	R/W	True
	Communication port 3 device stop bit	Local device	0	SPFW	355	Word	R/W	True
	Communication port 3 device parity bit	Local device	0	SPFW	356	Word	R/W	True
	Communication port 3 delay before sending	Local device	0	SPFW	357	Word	R/W	True
	Communication port 1 station number shielding	Local device	0	SPFW	400	Bit	R/W	True
	Communication port 2 station number shielding	Local device	0	SPFW	416	Bit	R/W	True
	Communication port 3 station number shielding	Local device	0	SPFW	432	Bit	R/W	True
	VNC service control	Local	0	SPFW	451	Bit	R/W	True

type	label name	device name	station no.	address type	address	data type	read write mode	power-off holding
		device						
	Real time mode of communication register	Local device	0	SPFW	453	Bit	R/W	True

5-2-3. Custom label

According to personal usage habits, create tags for HMI internal addresses or device addresses, and view the usage of each tag address in this window.

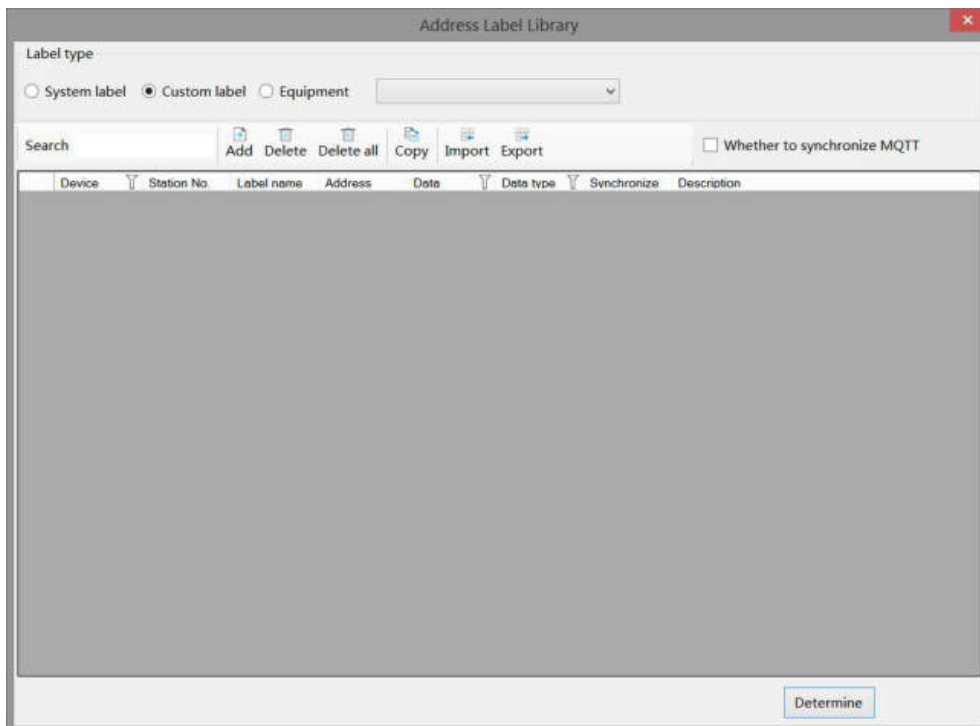

add	to add new address label.
variable	Set the label name for the address to be created.

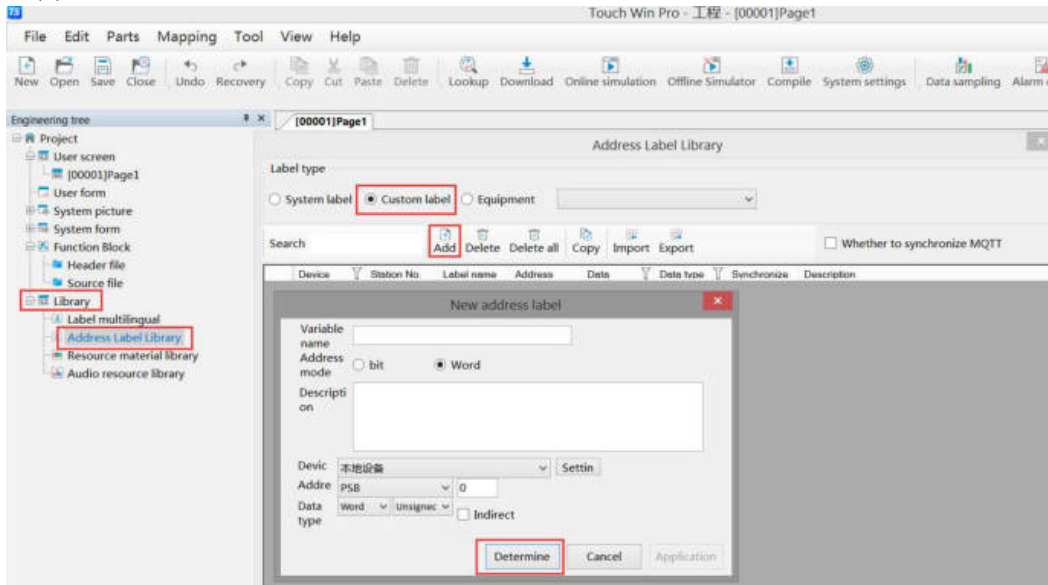
	name	
	address mode	Choose whether the address is a bit address or a word address.
	description	Set description information for the current address label, this is an optional item.
	device	Select the device where the address is located, and you can select a local device or a newly added device in the communication port.
	address	Set the address corresponding to the current label.
	data type	Set the data type for the current address.
	indirect specify	Set the current address offset, where the current register address changes with the indirectly specified register value, i.e. $Dx [Dy]=D [x+Dy \text{ numerical value}]$ ($x, y=0, 1, 2, 3\dots$). Example: The current register address is PSW0, if the indirectly specified address is PSW100; When the value of the PSW100 register is 0, the register that controls this component remains PSW0; When the value of the PSW100 register is 1, the register that controls this component is PSW1 (and so on).
	delete	Delete the specified address label.
	delete all	Delete all added address labels.
	copy	Copy the specified address label.
	paste	This item is only displayed when there is copied content, used to paste the copied address label at the specified location.
	export	Export the currently added address label in CSV format to the specified path in the computer.
	import	Import the CSV format address table of the specified path in the computer into the HMI.
	example	<p>The indicator button uses a user-defined label.</p> <p>(1) add custom label</p>  <p>after clicking ok, it will show below picture:</p>

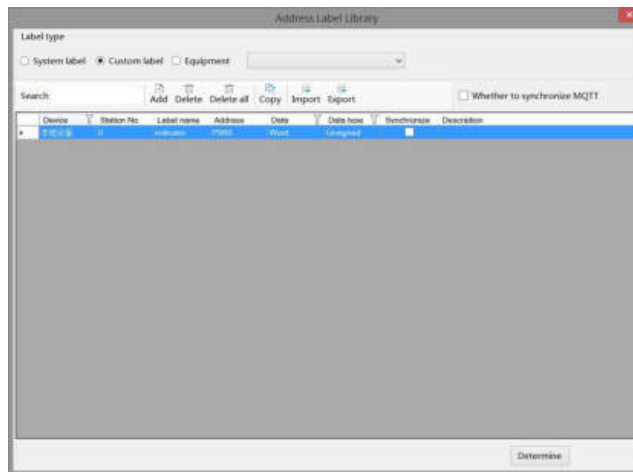

(2) use custom label

Place indicator buttons on the engineering screen and follow the steps shown in the following figure for configuration.

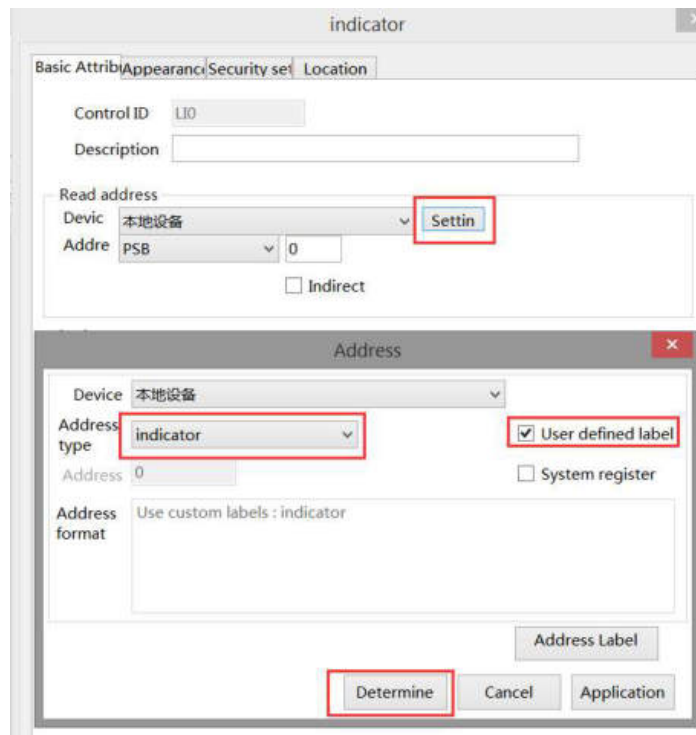

after clicking ok, it will show below picture:

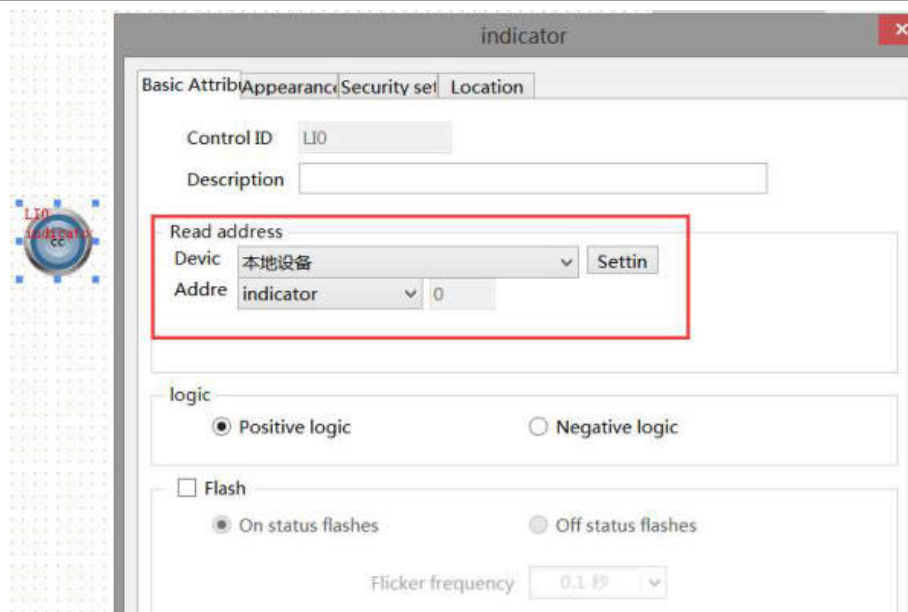

At the same time, the usage screen and window of customized label will also be displayed. Click on Library/ Address Label Library/ Custom Labels to view. (When a control reads/writes to the same address, “1 1” will appear as shown in the following figure)

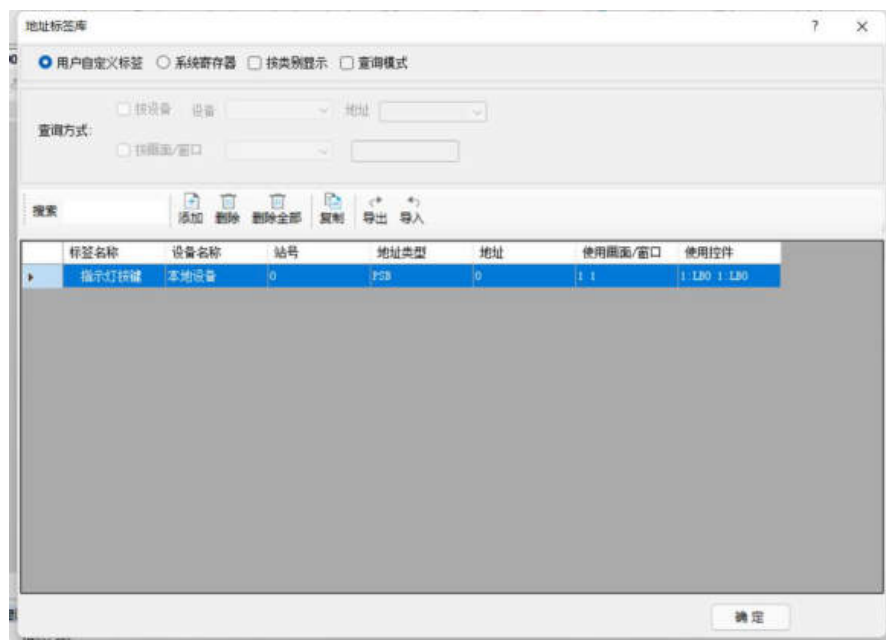

5-2-4. Equipment label

Mainly displaying device labels, currently suitable for displaying codesys labels.

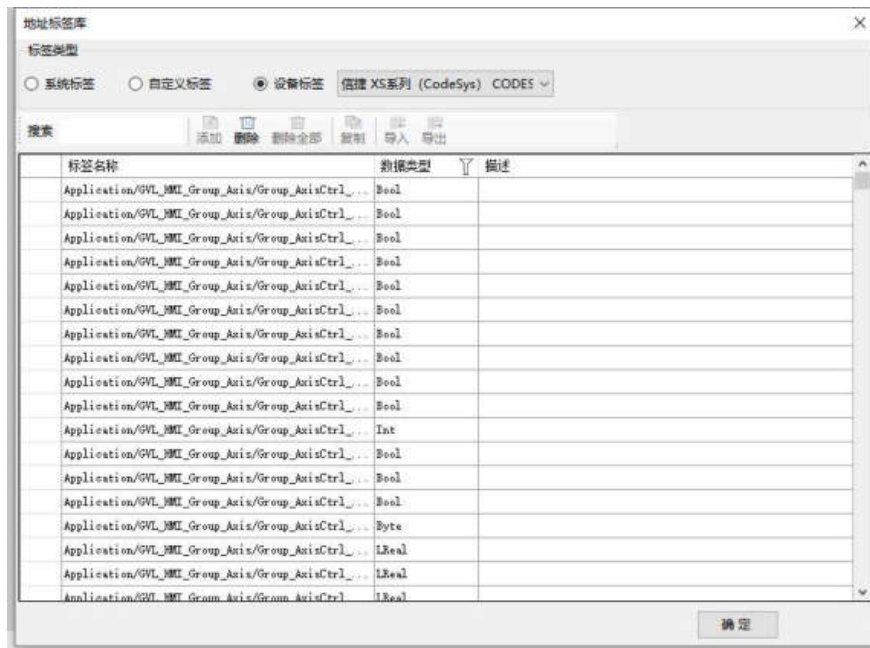

5-3. Resource material library

By accessing the resource material library, diversity in the appearance of editing tools can be achieved. Double click on the Project Tree/ Resource Material Library icon.





The resource material library selection image dialog box appears, as shown in the following figure:

5-4. Audio resource library

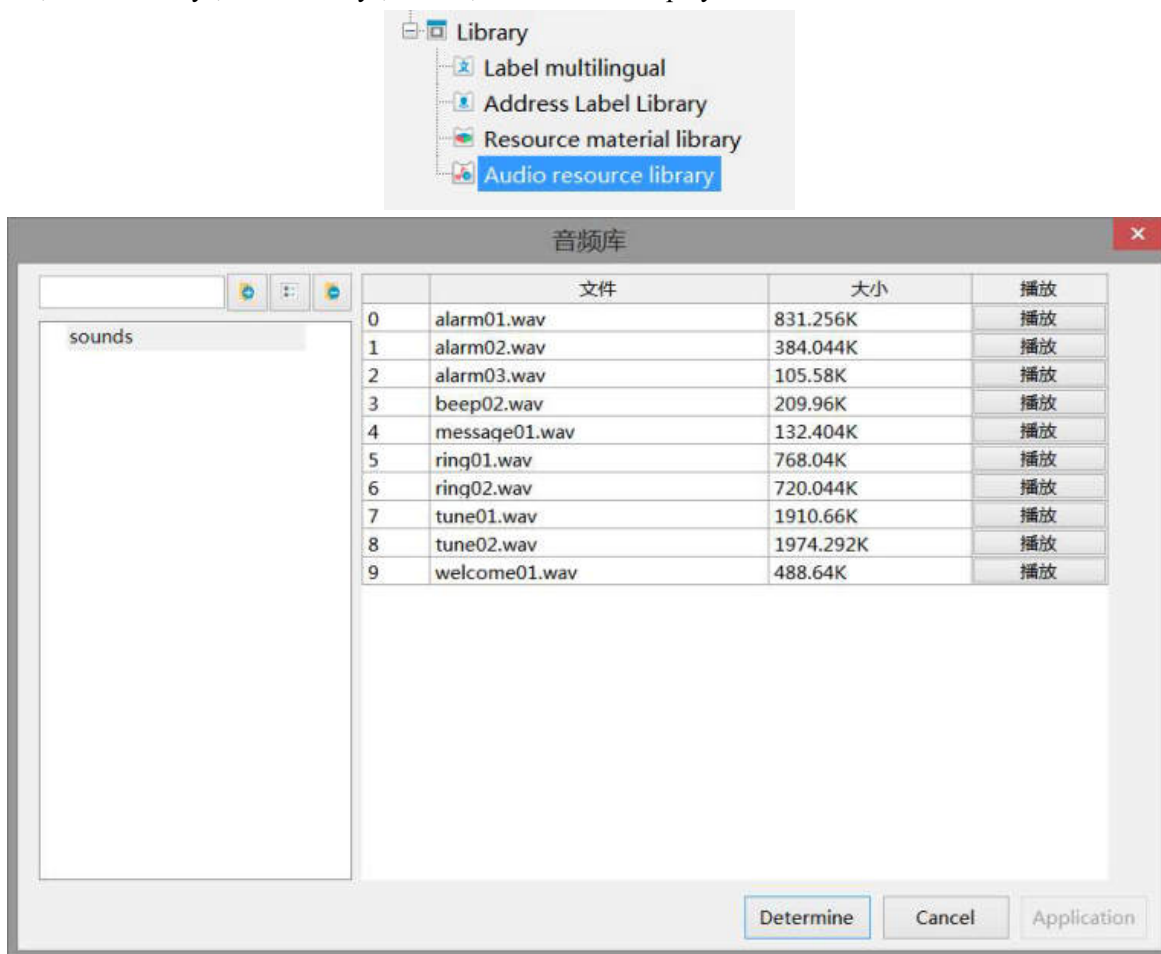
The audio resource library can manage all audio information in the software, including buttons, indicator buttons, character keys, function keys, alarms, and other audio playback functions.



add folder 	Add a folder containing audio to quickly add audio materials (currently only supports wav format)
delete folder 	Delete the selected folder, please note that if deleted by mistake, it cannot be restored
add material 	Add custom materials

Take the indicator button as an example (follow the steps in the figure).

Step 1: Select the indicator light button and place it on the screen.

Step 2: Set operation related parameters according to usage requirements. As shown in the figure, the setting is reversed, meaning that every time the indicator button is clicked, the status of the indicator button changes, and it also triggers the function of playing audio. (There is currently no pause function, as long as there is a trigger signal, the selected audio will be played completely).

Step 3: Check the start sound and click on the gray box behind it to enter the audio library interface.

Step 4 ~ Step 5: Select an audio file in the audio library, select it, and click OK.

Step 6: After clicking OK at the indicator button component, the selected audio name will be displayed in the gray box.

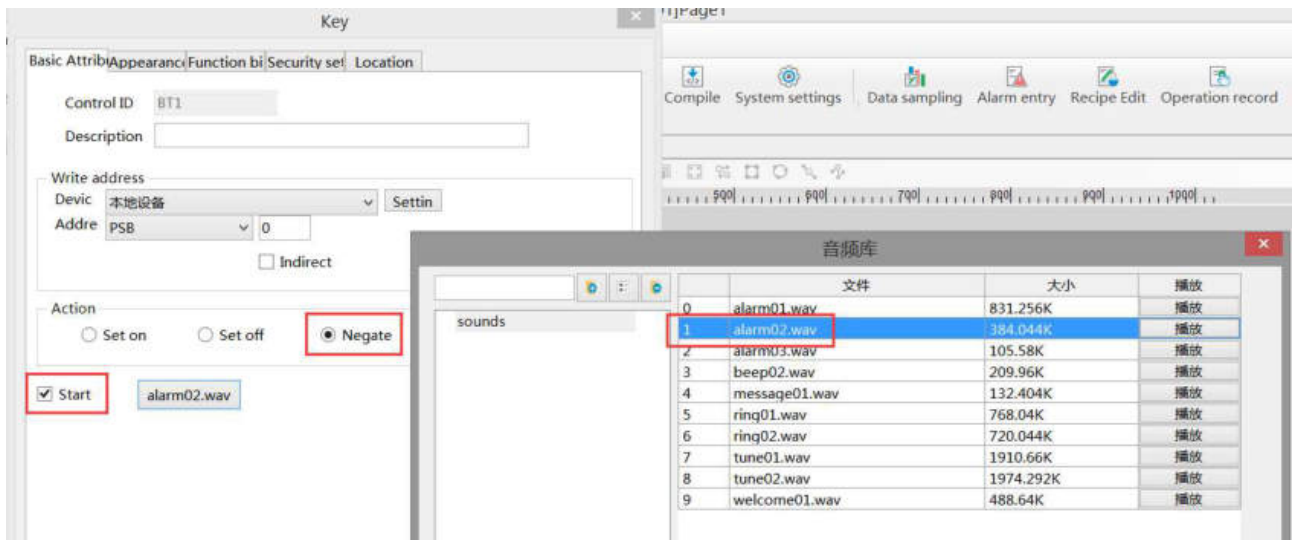

6. Function block

This chapter explains the usage of the C function by introducing the C instruction and combining some simple examples. Therefore, only some simple and easy to understand C function knowledge is used in the introduction. The main purpose is to help customers understand this function, understand some basic writing rules, and some precautions during use.

6-1. Function block introduction

6-1-1. Function block operating conditions

Unlike general TG series HMI, TS series HMI support function block offline/online simulation.

6-1-2. Build a function block

1. Open TouchWin Pro software, click engineering tree/project/function block/source file/add function.

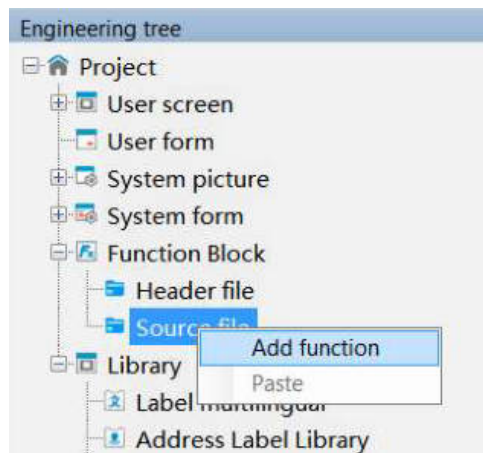

2. Fill in the basic information of the function block in the pop-up information dialog box, and click "OK" to create a new function. (Function block names can be up to 30 characters)

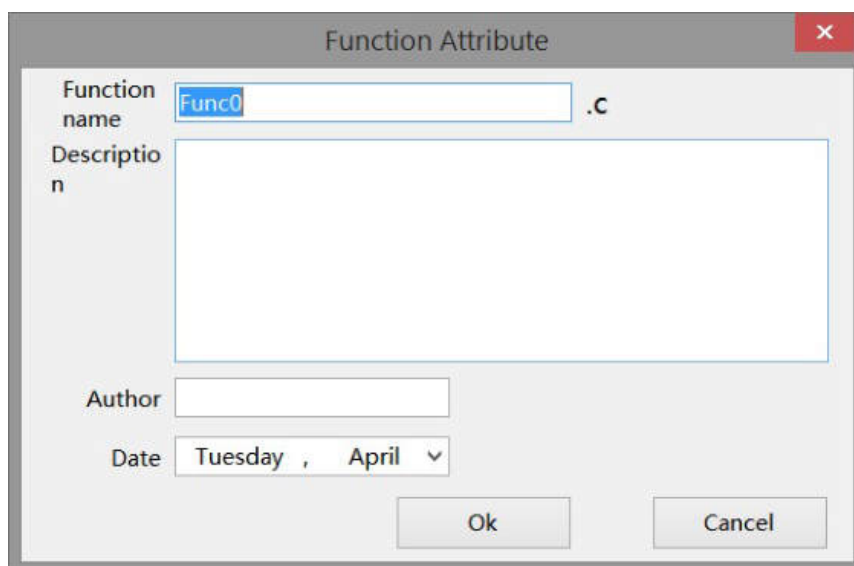

Function Name naming Rules Refer to 6-2-1 Writing Method.

3. Select the newly created function, double-click the left mouse button, and open the function block for function writing.

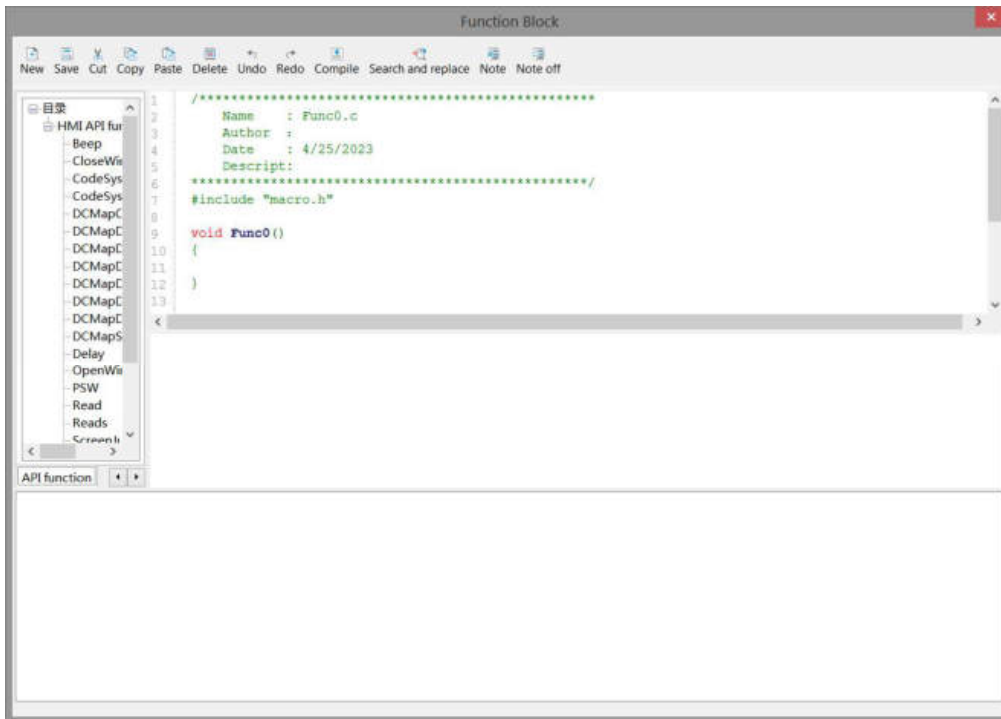

6-1-3. Function block compilation

Depending on the current use of the computer keyboard, users can compile functions by pressing the F5 key on the keyboard or the 'Compile' button on the menu bar during the editing process.

The compilation function can detect whether the function has syntax and writing errors, variable definitions, editing function errors, etc.

1. Grammar and writing errors

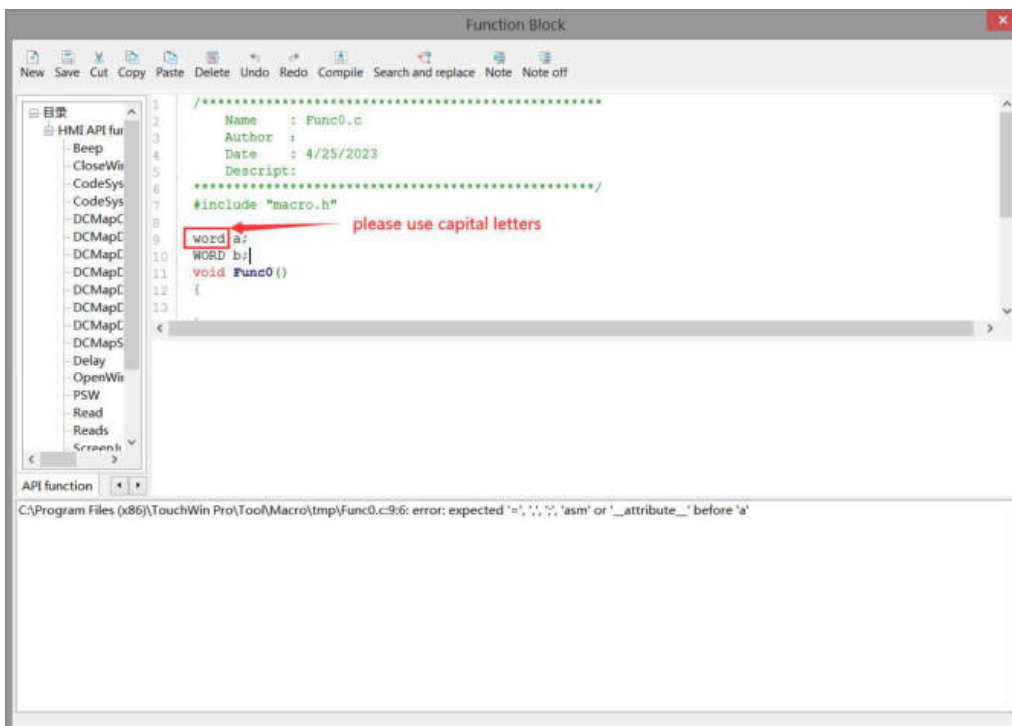

2. When using functions or macros in the function library, directly select the function to be used in the function library list, double-click it, or input the function in the editing area according to the format displayed in the function list:

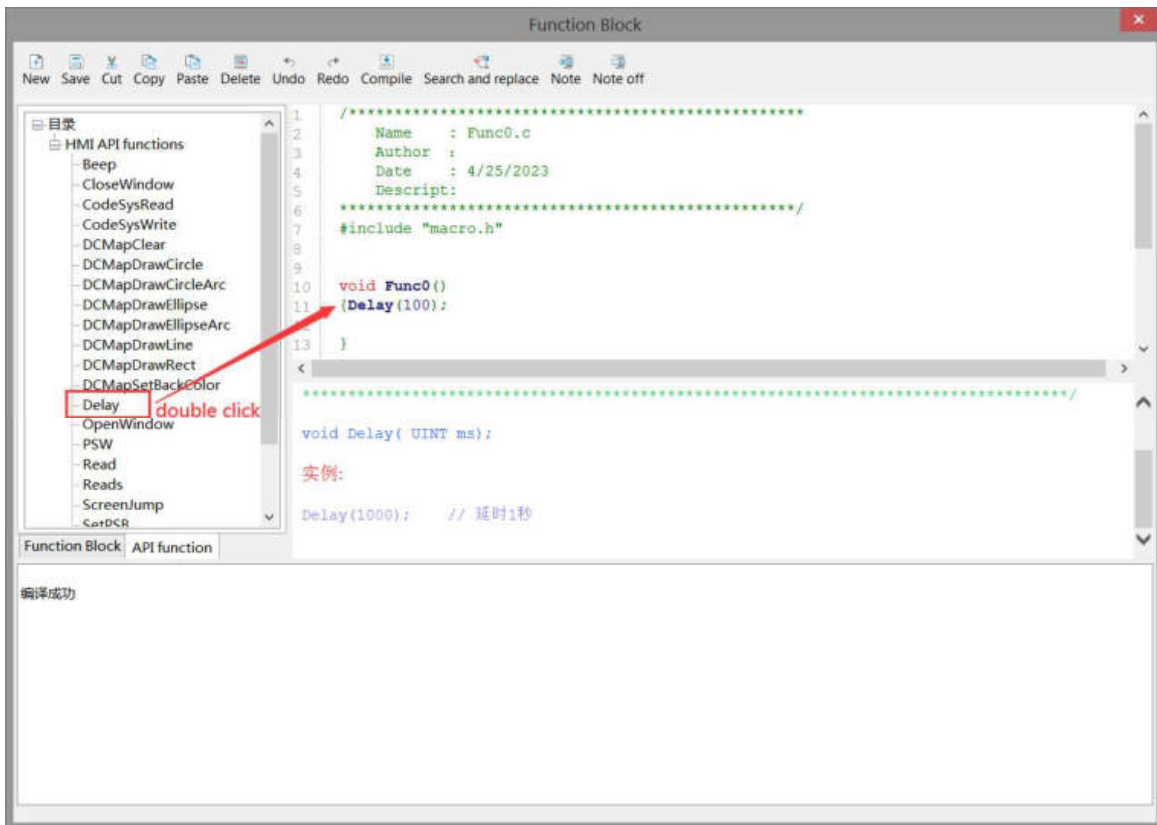

3. undefined variable

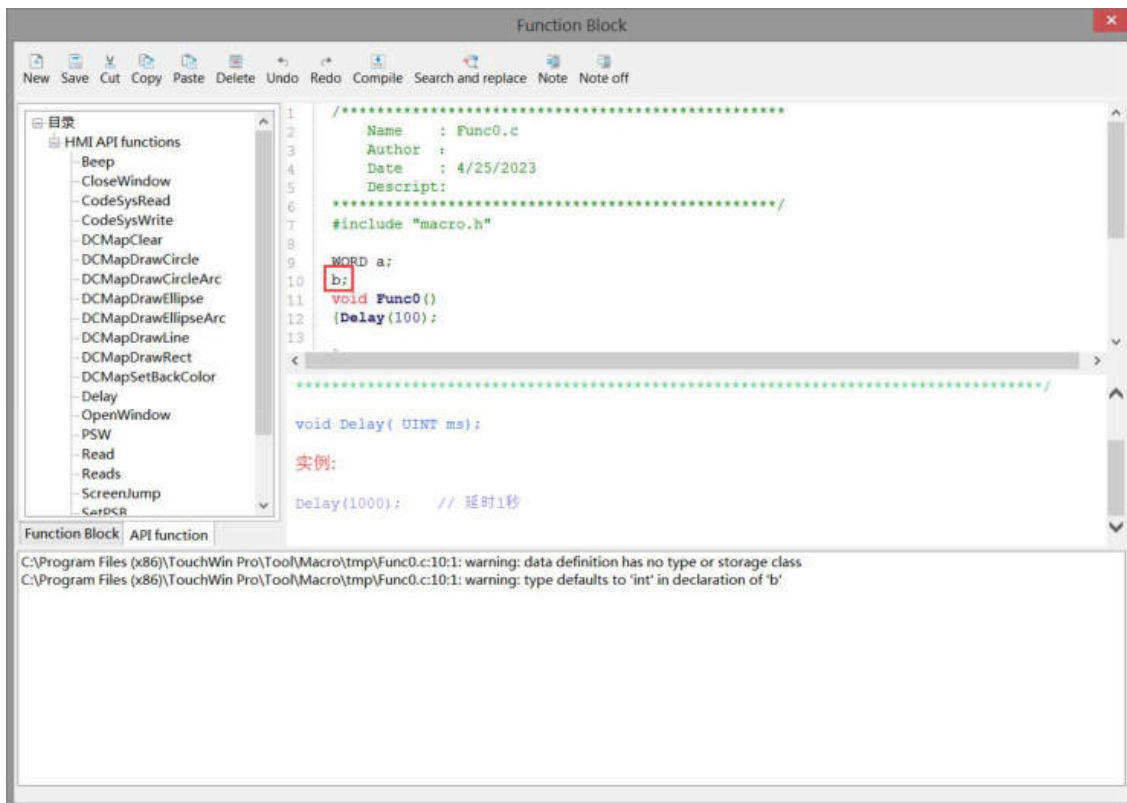

4. Function edit error

When operating functions, many users manually enter function names and variables within the function, which can easily lead to editing errors. When inputting functions, you can refer to the following usage methods:

For example, Read function: directly select "Read" in the API function list, double-click it, and the function will be displayed in the editing area. Then press "shift + (" key on the keyboard. The system will pop up the following dialog box, and you can set it directly.

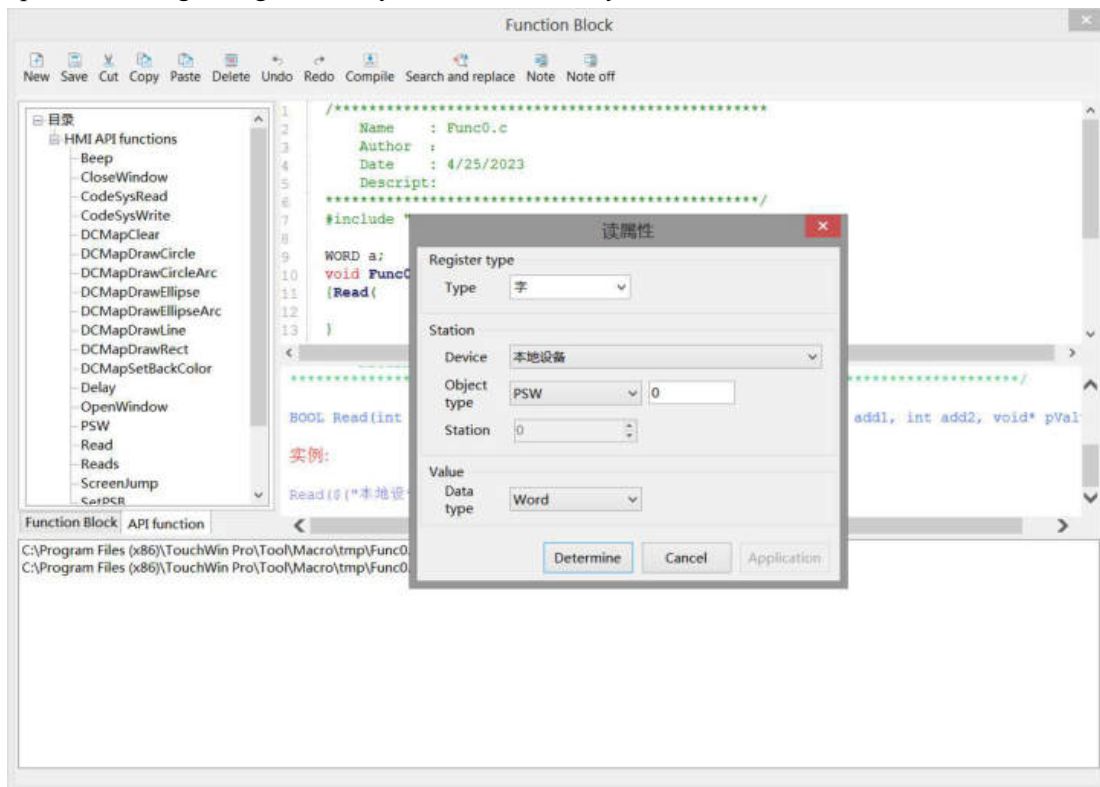

When editing functions, the input method needs to be set to English.

6-1-4. Run the function block

Users can choose function keys/functional domains/indicator buttons/buttons/multi state buttons to call function blocks according to their own needs. The specific introduction is as follows:

1. Function key calls function blocks

Place a function key on the screen, select "Function Call" from the "Optional Functions" on the right, and then click the "Add" button to add this function. Select "Call Function" on the left, and select the name of the function to be called to add the function.

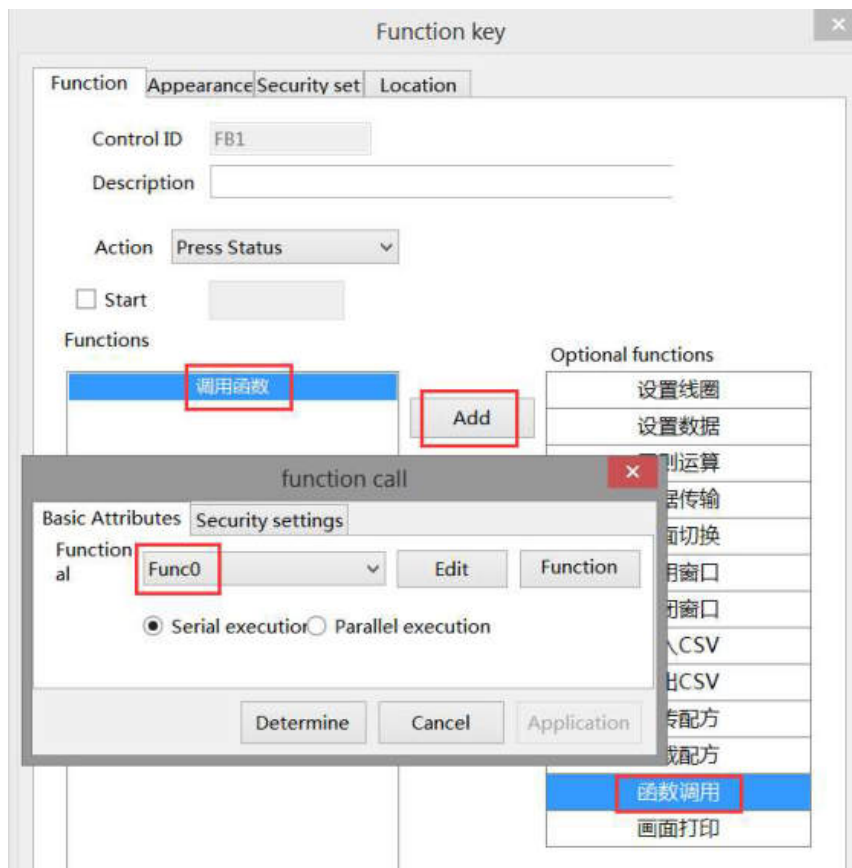

2. Function domain calls function blocks

1> Place a functional domain in the screen and set the "Action Mode" to "Continuous".

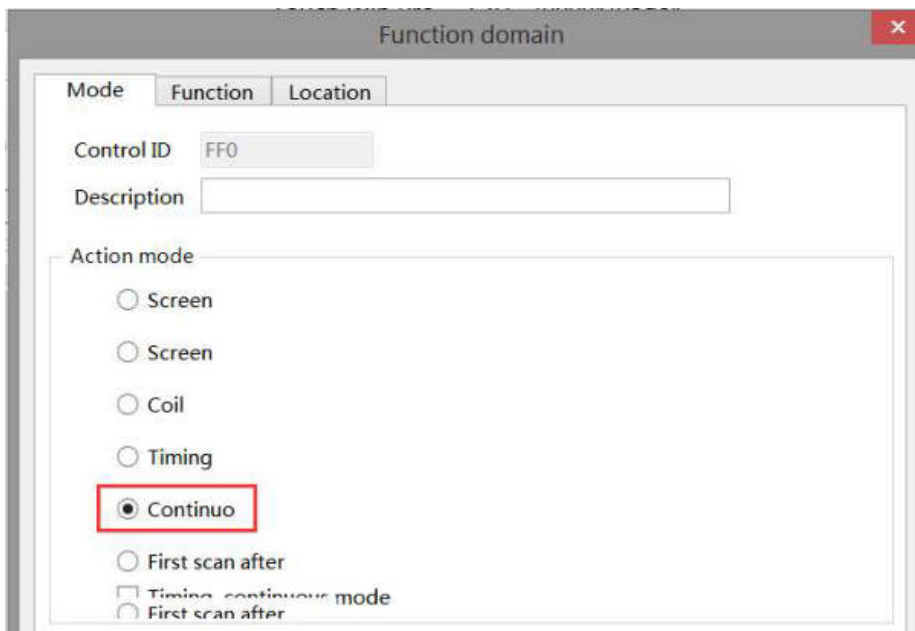

2> Function options: Select "Function Call" from the "Optional Functions" on the right, then click the "Add" button to add this function. Select "Call Function" on the left, and select the name of the function to be called to add the function.

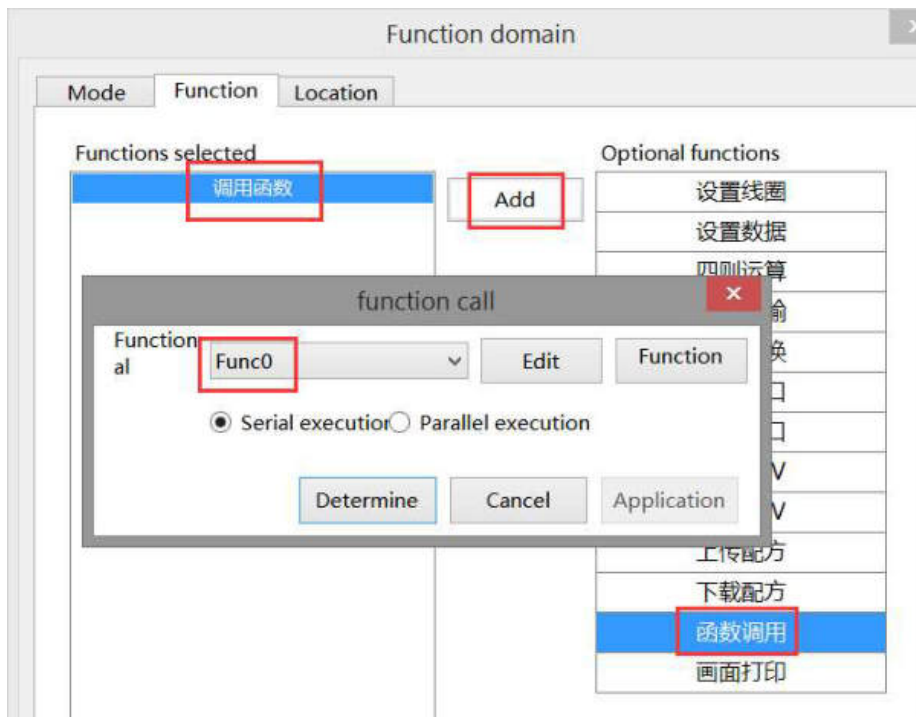

3. Indicator light button/button/multi state button call function block

Taking the indicator key as an example:

Place an indicator button on the screen and set it under the function binding bar. The setting steps are shown in the following figure. After setting, every time the indicator button is triggered, the set function will be called.

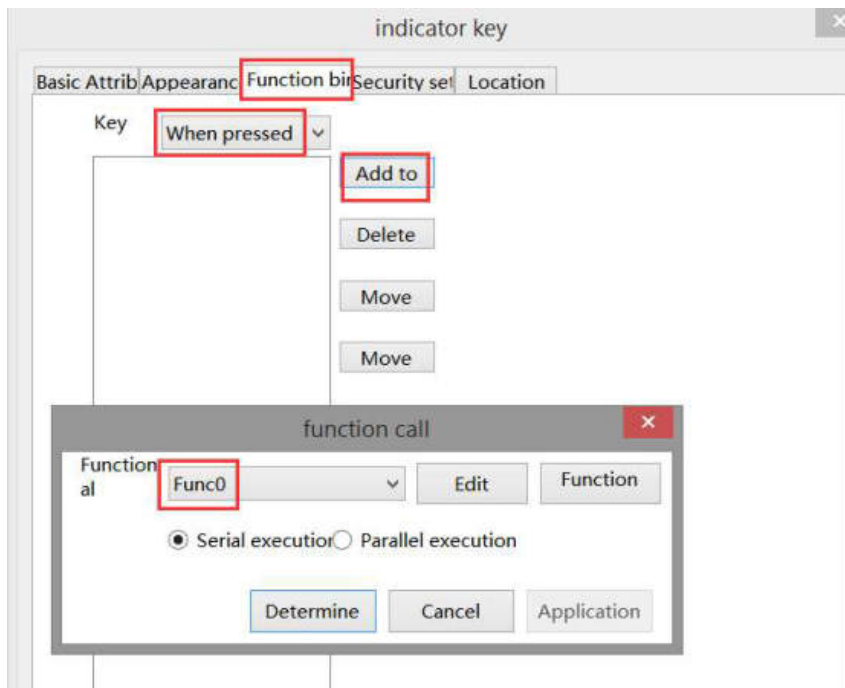

6-2. Function block explanation

6-2-1. Writing method

The writing of function block identifiers is entirely in accordance with the standard C language. The effective character sequence used to identify names in C language is called identifier, which refers to user-defined variable, function, constant, and statement symbol names.

■ Legal identifier

- (1) Composed of letters, numbers, and underscores
- (2) The first digit can only be a letter or an underscore
- (3) Cannot be exactly the same as the keywords in C language
- (4) 256 characters or less in length
- (5) The defined function name and variable name cannot be the same as the standard function name in C language

6-2-2. Function type

According to the usage of functions, the HMI editing software TouchWin Pro divides functions into header files and source files. The header file and source file are not function types, they are two different file types. The header file is "xxx. h" and the source file is "xxx. c".

■ Header file function

Header file: can define global variables, declare or implement functions, and the variables and functions defined in the header file can be used in the source file containing the header file. When the header file contains other header files, variables and functions in the header file can also be used.

Example:

```
Func.h
// System header files or other header files included
#include <stdio.h>           // use system header file<>
#include <string.h>
#include "Func1.h"         // use user-defined header file""

int a = 10;                // define the variables

void Test()               // realize the function
{
    a = 20;
}

int Add(int a, int b);    // declare the function and implement it in the source file
```

■ Source file function

Source file: can define variables and implement specific function functions. It can be called through controls such as function keys, function domains, indicator buttons, buttons, and multi state buttons.

Example:

```
Func.c
```



```

#include "Func.h"

int b = 20;          // define the variables

int Add(int a, int b)
{
    return a + b;
}

```

6-2-3. Predefined data types

```

#pragma once
#include "funkey.h"

enum LocalRegType
{
    TP_PSB = 0,
    TP_SPSB,
    TP_PSW,
    TP_PFW,
    TP_SPSW,
    TP_SPFW,
    TP_COUNT,
};

enum VarDataType
{
    DT_Bit = 0x1,
    DT_Byte = 0x2,
    DT_WORD = 0x4,
    DT_DWORD = 0x8,
    DT_DDWORD = 0x10,
    DT_String = 0x20,
    DT_Bytes = 0x40,
    DT_Words = 0x80,
    DT_DWords = 0x100,
    DT_DDWords = 0x200,
};

enum NewVarDataType
{
    DT_Word = 0x4,
    DT_DWord = 0x8,
    DT_DDWord = 0x10,
    DT_Byte_String = 0x40,
}

```

```

DT_Word_String = 0x80,
DT_DWord_String = 0x100,
DT_DDWord_String = 0x200,
};

typedef int(*_Sys_HMIMacroApi)(const char* apiid, void *param);
extern int _MID(int mapid);
typedef char bool;
typedef unsigned int DWORD;
typedef unsigned short WORD;

```

6-2-4. Predefined macro instructions

```

#define Max(a,b)          (((a) > (b)) ? (a) : (b))
Eg. Max(3, 4) == 4
#define Min(a,b)         (((a) < (b)) ? (a) : (b))
Eg. Min(3, 4) == 3
#define MAKEWORD(byl, byh) ((WORD)(((BYTE)(byl) | ((WORD)((BYTE)(byh))) << 8))
Eg. MAKEWORD(0x01, 0x02) == 0x0201
#define MAKELONG(wl,wh)  ((long)(((WORD)(wl)|((DWORD)((WORD)(wh))) <<16))
Eg. MAKEDWORD(0x01, 0x02) == 0x00020001
#define LOWORD(l)        ((WORD)(l))
Eg. LOWORD(0x00020001) == 0x0001
#define HIWORD(l)        ((WORD)(((DWORD)(l) >> 16) & 0xFFFF))
Eg. HIWORD(0x00020001) == 0x0002
#define LOBYTE(w)        ((BYTE)(w))
Eg. LOBYTE(0x0201) == 0x01
#define HIBYTE(w)        ((BYTE)(((WORD)(w) >> 8) & 0xFF))
Eg. HIBYTE(0x0201) == 0x02

```

6-2-5. API function

6-2-5-1. Read/Write

function	Read and write operations (for reading and writing bits and registers)	
format	read operation	void Read(int devId, int staID, int objType, int dataType, int add1, int add2, void* pValue);
	write operation	void Write(int devId, int staID, int objType, int dataType, int add1, int add2, void pValue);
note	devId:	device ID
	staID:	station no.
	objType:	Register Address Type
	dataType:	Register data type DT_Bit Enumeration Type, occupy 1 byte DT_Byte occupy 1 byte

		DT_WORD	occupy 2 bytes
		DT_DWORD	occupy 4 bytes
		DT_DDWORD	occupy 8 bytes
	add1,add2:	register address	
	pValue:	data buffer (The length should match the dataType)	
	return value	TRUE / FALSE (Success/Failure)	
example	<pre> bool bValue;// Define a Boolean variable WORD wValue;// Define an integer variable Read(_T("Xinje XD/XL/XG series (Modbus RTU)", 1, TP2_M, DT_Bit, 0, 0, &bValue);//read bit M0 Read(_T("Xinje XD/XL/XG series (Modbus RTU)", 1, TP2_D, DT_WORD, 0, 0, &wValue);//read D0 Write(_T("Xinje XD/XL/XG series (Modbus RTU)", 1, TP2_M, DT_Bit, 10, 0, bValue);//write bit M10 Write(_T("Xinje XD/XL/XG series (Modbus RTU)", 1, TP2_D, DT_WORD, 10, 0, wValue);//write D10 </pre>		
caution	When writing Read functions, be sure to add the&addressing character		

6-2-5-2. Reads/Writes

function	read write register groups	
format	read operation	void Reads(int devId, int staID, int objType,int dataType, int addr,int addr1, int regs, void* pRegs);
	write operation	void Writes(int devId, int staID, int objType,int dataType, int addr,int addr1, int regs, void* pRegs);
note	devId:	device ID
	staID:	station no.
	objType:	register address type
	dataType:	register data type
	addr addr1:	register address
	regs:	register numbers
	pRegs:	data buffer (The length should match the size of the register group that needs to be read and written)
return value:	TRUE / FALSE (Success/Failure)	
example	<pre> WORD wValue [10];// Define an integer variable Reads(_T("XINJE XD/XL/XG series (Modbus RTU)", 1, TP2_D, DT_WORD, 0, 0, 10, wValue); //read D0 group Writes(_T("XINJE XD/XL/XG series (Modbus RTU)", 1, TP2_D, DT_WORD, 100, 0, 10,wValue);//write D100 group </pre>	
caution	Read and write data for floating point numbers and multiple continuous address registers.	

6-2-5-3. WriteF

function	Write register (used to write floating point number)	
format	BOOL WriteF(int devId, int staID, int objType, int dataType, int add1, int add2, void pValue);	
note	devId:	device ID
	staID:	station no.
	objType:	register address type
	dataType:	register data type
	add1,add2:	register address
	pValue:	data buffer (The length should match the dataType type)
	return value:	TRUE / FALSE (Success/Failure)
example	<pre>double bValue;// Define a double precision variable WriteF(_T("XINJE XD/XL/XG series (Modbus RTU)", 1, TP2_D, DT_DDWORD, 0, 0,bValue);//write D0</pre>	

6-2-5-4. Delay

function	delay	
format	void Delay(UINT ms);	
note	ms:	delay time (unit: ms)
example	Delay(10); //delay 10ms	
	Delay(1000); //delay 1s	

6-2-5-5. ScreenJump

function	screen jump	
format	WORD ScreenJump(WORD ScreenNo);	
note	screenNo:	screen no.
example	Return:	jump to screen no.
	ScreenJump(2); //jump to screen no.2	

6-2-5-6. OpenWindow

function	open window	
format	void OpenWindow(int winNo, int winX, int winY);	
note	winNo:	window no.
example	winX:	Start position of window X-axis
	winY:	Start position of window Y-axis
	OpenWindow(5001,10,10); //display window 5001 at the location (10, 10)	

6-2-5-7. CloseWindow

function	close window	
format	void CloseWindow(WORD winNo);	
note	winNo:	window no.

example	<code>CloseWindow(5001);</code> //close window no. 5001
---------	---

6-2-5-8. Beep

function	Buzzer sounds once
format	<code>void Beep(void);</code>
example	<code>Beep();</code> // Buzzer sounds once

6-2-5-9. PSW

function	PSW register can be operated directly, the type is unsigned short (i.e. WORD)
example	<code>PSW[300]++;</code> // PSW[300]++ as word
	<code>DWORD dwValue = *(DWORD*)(PSW + 300);</code> // send the value in PSW[300] and PSW[301] to a double word
	<code>float fValue = *(float*)(PSW + 300);</code> // read the value in PSW[300] and PSW[301] as floating number format
	<code>*(DWORD*)(PSW + 300) = dwValue;</code> // set a double word value to PSW[300] and PSW[301]

6-2-5-10. SetPSB

function	set ON/OFF PSB
format	<code>SetPSB(addr, val) ;</code>
note	Addr: register address
	Val: data buffer, 1-ON;0-OFF
example	<code>SetPSB(0,1);</code> //set ON PSB0 <code>SetPSB(0,0);</code> //set OFF PSB0

6-2-5-11. DCMaPSetBackColor

function	Modify the background color of the function canvas
format	<code>BOOL DCMaPSetBackColor(DWORD dwDCMaPID, DWORD BackColor)</code>
note	dwDCMaPID: Set Function Canvas Number
	BackColor: Set color values, usually entered in hexadecimal, such as 0x00ff00
example	<code>DCMaPSetBackColor(1,0x000000);</code> // Fill the background color of the function canvas number 1 with black
caution	The TS series HMI uses RGB mode, where one color occupies one byte, i.e. 0xFF0000 represents B (BLUE), 0x00FF00 represents G (Green), and 0x0000FF represents R (RED).

6-2-5-12. DCMaPDrawLine

function	Custom Line Drawing
format	<code>BOOL DCMaPDrawLine(DWORD dwDCMaPID, int x, int y, int Width, int Height, int linewidth, DWORD color)</code>
note	dwDCMaPID: Set Function Canvas Number
	x: Set the X-axis coordinate point value of the starting point of the line using the

		upper left corner of the function canvas as the coordinate origin (0,0)
	y:	Set the Y-axis coordinate point value of the starting point of the line using the upper left corner of the function canvas as the coordinate origin (0,0)
	Width:	Set the Y-axis coordinate point value of the endpoint of the line using the upper left corner of the function canvas as the coordinate origin (0,0)
	Height:	Set the Y-axis coordinate point value of the endpoint of the line using the upper left corner of the function canvas as the coordinate origin (0,0)
	Linewidth:	Set the line width, i.e. thickness
	Color:	Set Line Color Values
example	<pre> int x_pos,y_pos,line_height,line_width,linewidth; DWORD line_color; x_pos=PSW[300]; y_pos=PSW[301]; line_color=*(DWORD*)(PSW+302); line_height=PSW[304]; line_width=PSW[305]; linewidth=PSW[306]; DCMapClear(1; // Use the DCMapClear command to delete the drawing during use DCMapDrawLine(1,x_pos,y_pos,line_width,line_height,linewidth,line_color); </pre>	

6-2-5-13. DCMapDrawRect

function	Custom Draw Rectangle	
format	BOOL DCMapDrawRect (DWORD dwDCMapID, int x, int y, int Width, int Height, int linewidth, DWORD color, BOOL FillRect, DWORD FillColor)	
note	dwDCMapID:	Set Function Canvas Number
	x:	Set the X-axis coordinate point value of the starting point of the rectangle using the upper left corner of the function canvas as the coordinate origin (0,0)
	y:	Set the Y-axis coordinate point value of the starting point of the rectangle using the upper left corner of the function canvas as the coordinate origin (0,0)
	Width:	Set rectangular width value
	Height:	Set rectangular height value
	Linewidth:	Set the width of the rectangular line, i.e. thickness
	Color:	Set the color value of rectangular edges
	FillRect:	Set whether the interior of the rectangle needs to be filled, 0 is not filled, and 1 is filled
	FillColor:	Set the fill color value. If FillRect is set to 0, the fill color setting is invalid
example	<pre> int x_pos,y_pos,rec_height,rec_width,linewidth; DWORD rec_color,fillcolor; bool Fill; Read(_T("local device"), 0, TP_PSB, DT_Bit, 300, 0, &Fill); x_pos=PSW[300]; y_pos=PSW[301]; rec_color=*(DWORD*)(PSW+302); </pre>	

	<pre> rec_height=PSW[304]; rec_width=PSW[305]; linewidth=PSW[306]; fillcolor=*(DWORD*)(PSW+308); DCMapClear(1); DCMapDrawRect(1,x_pos,y_pos,rec_width,rec_height,linewidth,rec_color,Fill,fillcolor); </pre>
--	--

6-2-5-14. DCMapDrawCircle

function	Custom circle drawing	
format	BOOL DCMapDrawCircle(DWORD dwDCMapID, int x, int y, int Radius, int linewidth, DWORD color, BOOL FillRect, DWORD FillColor)	
note	dwDCMapID:	Set Function Canvas Number
	x:	Set the X-axis coordinate point value of the center display position using the upper left corner of the function canvas as the coordinate origin (0, 0)
	y:	Using the upper left corner of the function canvas as the coordinate origin (0, 0), set the Y-axis coordinate point value for the center display position
	Radius:	Set circle radius
	Linewidth:	Set the width of the circular line, i.e. thickness
	Color:	Set the color value of the circular edge
	FillRect:	Set whether to fill the interior of the circle, 0 for no filling, 1 for filling
	FillColor:	Set the circle fill color value. If FillRect is set to 0, the fill color setting is invalid
example	<pre> int x_pos,y_pos,Radius,linewidth; DWORD circle_color,fillcolor; bool fill; Read(_T("local device"), 0, TP_PSB, DT_Bit, 300, 0, &fill); x_pos=PSW[300]; y_pos=PSW[301]; circle_color=*(DWORD*)(PSW+302); Radius=PSW[304]; linewidth=PSW[306]; fillcolor=*(DWORD*)(PSW+308); DCMapClear(1); DCMapDrawCircle(1,x_pos,y_pos,Radius,linewidth,circle_color,fill,fillcolor); </pre>	

6-2-5-15. DCMapDrawCircleArc

function	Custom arc drawing	
format	BOOL DCMapDrawCircleArc(DWORD dwDCMapID, int x, int y, int Radius, int linewidth, DWORD color, DWORD StartAngle, DWORD EndAngle)	
note	dwDCMapID:	Set Function Canvas Number
	x:	Using the upper left corner of the function canvas as the coordinate origin (0, 0), set the X-axis coordinate point value for the display position of the arc center

	y:	Using the upper left corner of the function canvas as the coordinate origin (0,0), set the Y-axis coordinate point value for the display position of the arc center
	Radius:	Set the arc radius value
	Linewidth:	Set the arc line width value, i.e. thickness
	Color:	Set the color value of arc edges
	StartAngle:	Set the starting angle value of the arc, which is the angle between the line connecting the base point and starting point and the horizontal 0 °
	EndAngle:	Set the angle value of the endpoint of the arc, which is the angle between the line connecting the base point and endpoint and the horizontal 0 °
example	<pre> int x_pos,y_pos,Radius,linewidth; DWORD circle_color; float StartAngle,EndAngle; x_pos=PSW[300]; y_pos=PSW[301]; circle_color=*(DWORD*)(PSW+302); Radius=PSW[304]; linewidth=PSW[306]; StartAngle=*(float*)(PSW+308); EndAngle=*(float*)(PSW+310); DCMapClear(1); DCMapDrawCircleArc(1,x_pos,y_pos,Radius,linewidth,circle_color,StartAngle,EndAngle); </pre>	
caution	Taking the arc origin (center point) as the base point, the direction to the right of the horizontal line passing through that base point is horizontal 0 °.	

6-2-5-16. DCMapDrawEllipse

function	Customize drawing ellipses	
format	BOOL DCMapDrawEllipse(DWORD dwDCMapID, int x, int y, int X_Axis_Len, int Y_Axis_Len, int linewidth, DWORD color, BOOL FillRect, DWORD FillColor)	
note	dwDCMapID:	Set Function Canvas Number
	x:	Using the upper left corner of the function canvas as the coordinate origin (0, 0), set the display position of the ellipse origin X-axis coordinate point value
	y:	Using the upper left corner of the function canvas as the coordinate origin (0, 0), set the Y-axis coordinate point value of the ellipse origin display position
	X_Axis_Len:	Set the ellipse radius value of the X axis
	Y_Axis_Len:	Set the ellipse radius value of the Y axis
	Linewidth:	Set the elliptical line width, i.e. thickness
	Color:	Set elliptical edge color values
	FillRect:	Set whether to fill the interior of the ellipse, 0 for no filling, 1 for filling
	FillColor:	Set the fill color value. If FillRect is set to 0, the fill color setting is invalid
example	<pre> int x_pos,y_pos,x_Axis,Y_Axis,linewidth; DWORD E_color,fillcolor; bool Fill; x_pos=PSW[300]; </pre>	

	<pre> y_pos=PSW[301]; E_color=*(DWORD*)(PSW+302); x_Axis=PSW[305]; Y_Axis=PSW[304]; linewidth=PSW[306]; Read(_T("local device"), 0, TP_PSB, DT_Bit, 300, 0, &Fill); fillcolor=*(DWORD*)(PSW+308); DCMapClear(1); DCMapDrawEllipse(1,x_pos,y_pos,x_Axis,Y_Axis,linewidth,E_color,Fill,fillcolor); </pre>
caution	The function parameters x and y are the origin (center point) of the ellipse, not the focal point.

6-2-5-17. DCMapDrawEllipseArc

function	Customize drawing elliptical arcs
format	BOOL DCMapDrawEllipseArc(DWORD dwDCMapID, int x, int y, int X_Axis_Len, int Y_Axis_Len, int linewidth, DWORD color, DWORD StartAngle, DWORD EndAngle)
note	dwDCMapID: Set Function Canvas Number
	x: Using the upper left corner of the function canvas as the coordinate origin (0, 0), set the display position of the elliptical arc origin X-axis coordinate point value
	y: Using the upper left corner of the function canvas as the coordinate origin (0, 0), set the display position of the elliptical arc origin Y-axis coordinate point value
	X_Axis_Len: Set the X-axis radius value of the elliptical arc
	Y_Axis_Len: Set the Y-axis radius value of the elliptical arc
	Linewidth: Set the width of the elliptical arc line, i.e. thickness
	Color: Set the color value of elliptical arc edges
	StartAngle: Set the starting angle value of the elliptical arc, which is the angle between the line connecting the base point and starting point and the horizontal 0 °
EndAngle: Set the angle value of the endpoint of the elliptical arc, which is the angle between the line connecting the base point and endpoint and the horizontal 0 °	
example	<pre> int x_pos,y_pos,x_Axis,Y_Axis,linewidth; DWORD eArc_color; float StartAngle,EndAngle; x_pos=PSW[300]; y_pos=PSW[301]; eArc_color=*(DWORD*)(PSW+302); x_Axis=PSW[305]; Y_Axis=PSW[304]; linewidth=PSW[306]; StartAngle=*(float*)(PSW+308); EndAngle=*(float*)(PSW+310); DCMapClear(1); DCMapDrawEllipseArc(1,x_pos,y_pos,x_Axis,Y_Axis,linewidth,eArc_color,StartAngle,EndAngle); </pre>
caution	Taking the origin (center point) of the elliptical arc as the base point, the direction to the right of

	the horizontal line passing through the base point is horizontal 0 °. The function parameters x and y are the origin (center point) of the elliptical arc, not the focal point.
--	---

6-2-5-18. DCMAPClear

function	Clear Canvas Content
format	BOOL DCMAPClear(DWORD dwDCMapID)
note	dwDCMapID: Set Canvas Number
example	DCMAPClear(1); // Clear the contents of the function canvas number 1

6-2-5-19. CodeSysRead/CodeSysWrite

Function	Read and write codesys label address operation (used for reading and writing bits and word registers)	
Format	Read operation	BOOL CodeSysRead(int devId, char * labelName, int count, int labelType, void* pValue);
	Write operation	BOOL CodeSysWrite(int devId, char * labelName, int count, int dataType, void* pValue);
Note	devId:	CodeSys device ID
	labelName:	CodeSys label name
	count:	Operation quantity
	labelType:	CodeSys label type
	pValue:	Numerical buffer (length should match dataType type)
Example	<pre> bool bValue;// Define a bool variable float fValue;// Define a floating-point word type CodeSysRead(_T("Xinje XS series (CodeSys)"), "Application/GVL_HMI_Group_Axis/Group_AxisCtrl_InOut[0]/ib_axis enable", 1, 0, &bValue);// Read bit label ib_Axis Enable CodeSysRead(_T("Xinje XS series (CodeSys)"), "Application/GVL_HMI_Group_Axis/Group_AxisCtrl_InOut[0]/if_axis Jog speed", 1, 13, &fValue);// Read floating-point label if_Axis Jog speed CodeSysWrite(_T("Xinje XS series (CodeSys)"), "Application/GVL_HMI_Group_Axis/Group_AxisCtrl_InOut[0]/ib_axis enable", 1, 0, &bValue);// Read bit label ib_Axis Enable CodeSysWrite(_T("Xinje XS series (CodeSys)"), "Application/GVL_HMI_Group_Axis/Group_AxisCtrl_InOut[0]/if_axis Jog speed", 1, 13, &fValue);// Read floating-point label if_Axis Jog speed </pre>	
Note	When writing CodeSysRead/CodeSysWrite functions, be sure to add the & addressing symbol.	

6-2-5-20. CodeSysReadString/CodeSysWriteString

Function	Read and write codesys label address operation (used for reading and writing string registers)	
Format	Read string operation	BOOL CodeSysReadString(int devId, char * labelName, int count, int len, void* pValue);
	Write string operation	BOOL CodeSysWriteString(int devId, char * labelName, int count, int len, void* pValue);
Note	devId:	CodeSys device ID
	labelName:	CodeSys label name
	count:	Operation quantity
	len:	String length
	pValue:	Numerical buffer (length should match dataType type)
Example	<pre>char charValue[2]; // Define a string type variable CodeSysReadString(_T("Xinje XS series (CodeSys)", "Application/STR1[2]", 2, 20, &charValue); // Read string labels CodeSysWriteString(_T("Xinje XS series (CodeSys)", "Application/STR1[2]", 2, 20, &charValue); // Write string labels</pre>	
Note	When writing CodeSysReadString/CodeSysWriteString functions, be sure to add the & addressing symbol.	

6-2-5-21. Lock/Unlock

Function	Mutually exclusive locks; If multiple functions need to access a variable simultaneously, a mutex lock should be used. If Lock is used to lock an ID, the program that locks the ID again will block until it is unlocked by UnLock	
Format	Lock	void Lock(int id);
	UnLock	void Lock(int id);
Note	Id:	Range: 0~9
Example	<pre>// The following two functions run simultaneously: void func0() { Lock(1); PSW[123] = 55; UnLock(1); } void func1() { Lock(1); PSW[123] = 66; UnLock(1); }</pre>	

6-2-5-22. COMReceive

Function	Free Communication - Free Format Serial Port Reception Function	
Format	int COMReceive(int devId, char* buf, int len, unsigned short timeOut, unsigned short timeBytes)	
Note	devId:	Free format device identification
	buf:	Data buffer (length should match actual data length)
	len:	Data buffer length (in bytes)
	timeOut:	Time out in milliseconds, 0/greater than 0 (blocking until data is received/no data execution ends after timeout in milliseconds)
	timeBytes:	Frame interval, 0/greater than 0 (blocking until receiving len length data/exceeding timeBytes characters without data execution ends)
	Return:	-1/Greater than or equal to 0 (execution failed/actual received length)
Example	<pre>int result = -1; char data[256] = {0}; result = COMReceive(_T("free format"), data, 100, 0, 0); // Received 100 characters, execution ended result = COMReceive(_T("free format"), data, 100, 1000, 0); // If there is no data after 1000 milliseconds, the execution will end. Otherwise, if there are 100 characters received, the execution will end result = COMReceive(_T("free format"), data, 100, 1000, 10); // If there is no data execution end after 1000 milliseconds, otherwise the actual received length will be returned if there is no data execution end after receiving 100 characters or more than 10 characters</pre>	
Note	The timeout and frame interval are configured according to the requirements of the target communication device	

6-2-5-23. COMSend

Function	Free Communication - Free Format Serial Port Sending Function	
Format	int COMSend(int devId, char* buf, int len)	
Note	devId:	Free format device ID
	buf:	Data buffer (length should match actual data length)
	len:	Data buffer length (in bytes)
Example	<pre>int result = -1; char data[256] = {0}; // Send 100 characters result = COMSend(_T("free format"), data, 100);</pre>	
Communication example	<p>Taking Xinje PLC free communication as an example, equipment: XL5E; Function: Set Y0 to ON. The statement is as follows:</p> <pre>int result = -1; char snd[8] = {0}, data[8] = {0}; snd[0]=0x01; // Here is an example of modbus, which can be used according to the communication product protocol snd[1]=0x05; snd[2]=0x60; snd[3]=0x00;</pre>	

```
snd[4]=0xFF;
snd[5]=0x00;
snd[6]=0x92;
snd[7]=0x3A;
result = COMSend(_T("free format"), snd, 8);
```

6-3. Project example

6-3-1. Data compare

Example requirements:

Take three integers from the PLC for comparison, and output the maximum and minimum values for display on the HMI.

Example device:

- (1) One TS3-700-E and one XD5E-30T4-E
- (2) One USB download cable, one PLC communication cable, and one computer

Related information:

- (1) User Manual for XD/XL Series Programmable Controllers (Basic Instructions)
- (2) TouchWin Pro Editing Software User Manual

Operation process:

1. Establish C function block

In the Engineering Tree Function Block, right-click and select Add Function.

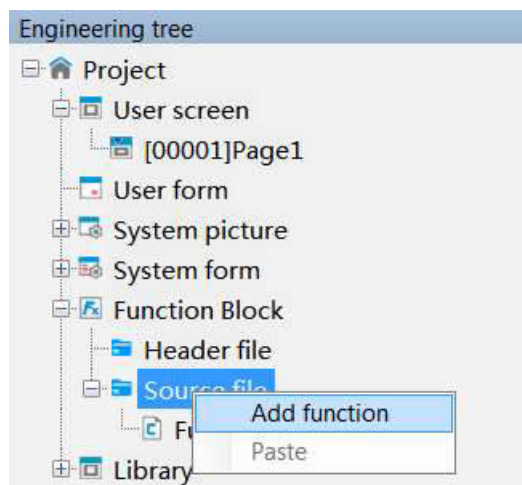

The function block information input box appears (as shown in the figure below), fill in the relevant information and click OK.

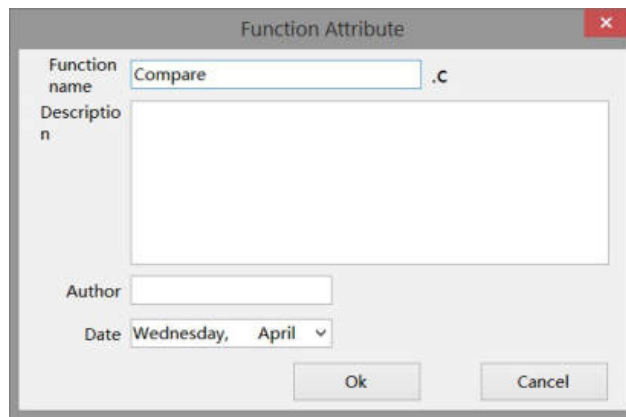

Establish a C function block editing environment, with the following functions:

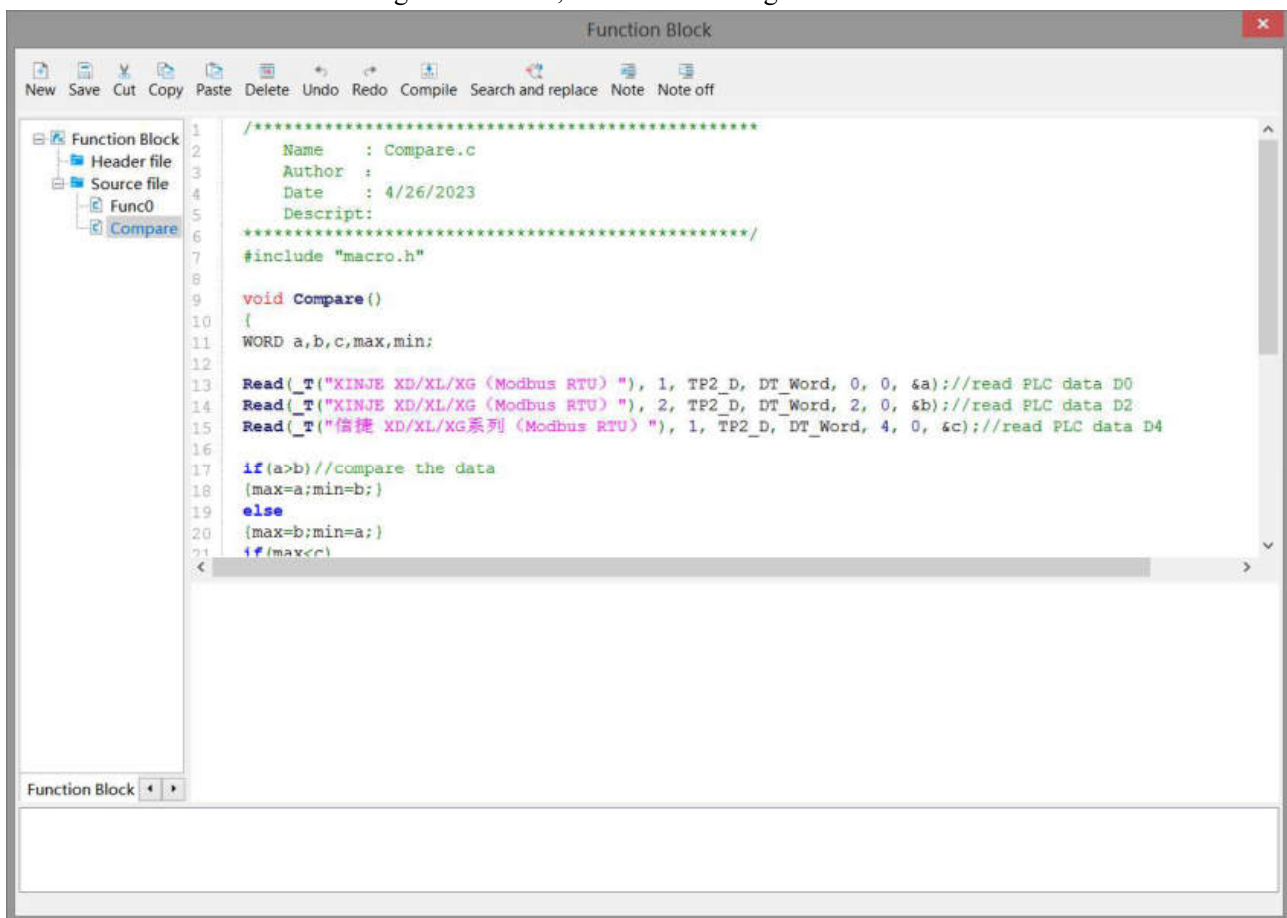

2. Call the function

Place a function key on the screen, and the remaining settings are shown in the following figure. Select "Function Call" from the "Optional Functions" on the right, then click the "Add" button to add this function. Double click "Call Function" in the "Selected Functions" section, and select the name of the function to be called in the "Function" section (select the newly created function "Compare" above) to add the function.

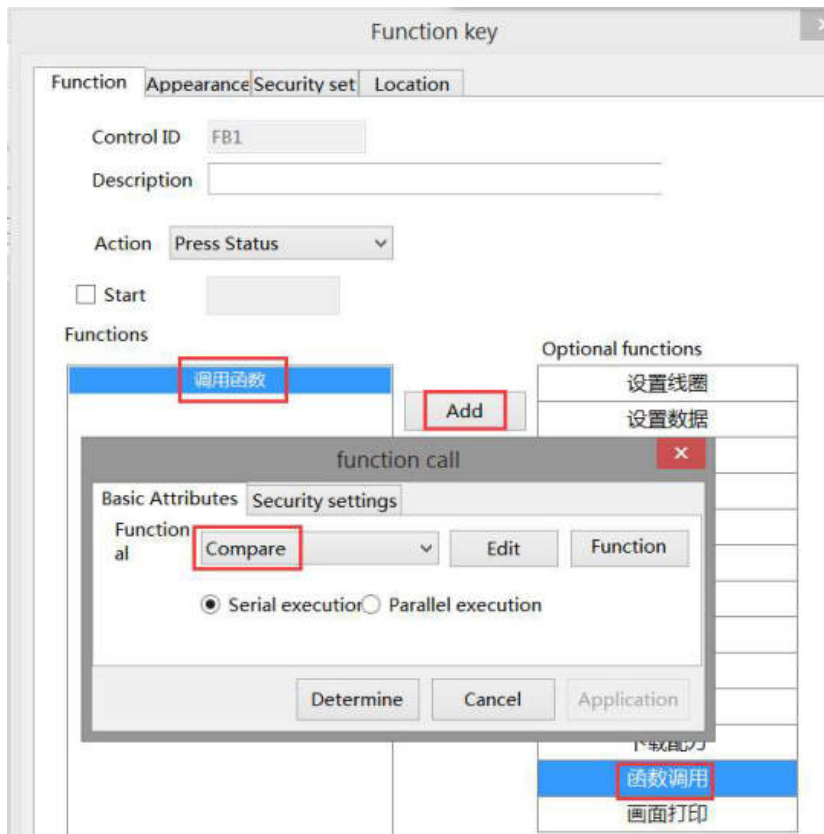

Click on the "Appearance" option, set the function key text to "Function Call", and finally click "OK" to complete the settings.

3. screen editing

Place 3 numerical inputs, addresses D0, D2, D4, 2 numerical displays, addresses PSW300, PSW301, 5 text strings, as follows:

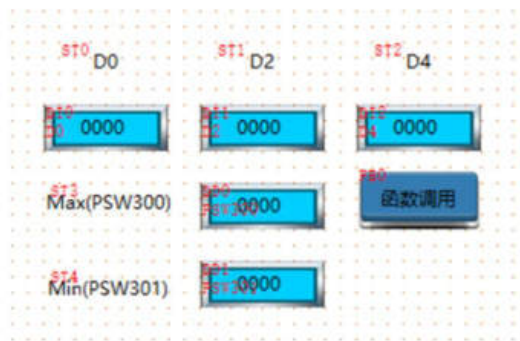

4. Finally, download the program to the HMI and connect it to the PLC for operation.

6-3-2. Clear the data block

Example requirements:

The data blocks in the PLC are cleared to zero.

Example device:

- (1) One TS3-700-E and one XD5E-30T4-E
- (2) One USB download cable, one PLC communication cable, and one computer

Related information:

- (1) TouchWin Pro Editing Software User Manual

Operation process:

1. Place 3000 data input components on the screen, with addresses set to D0, D1... D2999, and attributes set to WORD. The number of digits is 5, and unsigned number (i.e. WORD unsigned). As follows:

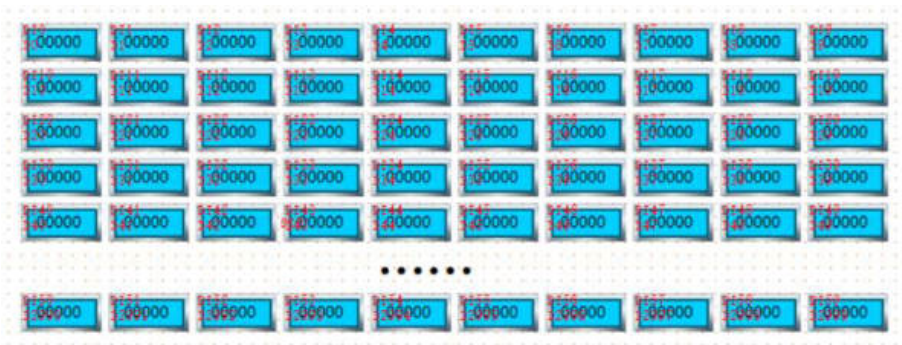

2. Establish C function block

In the Engineering Tree Function Block, right-click and select Add Function.

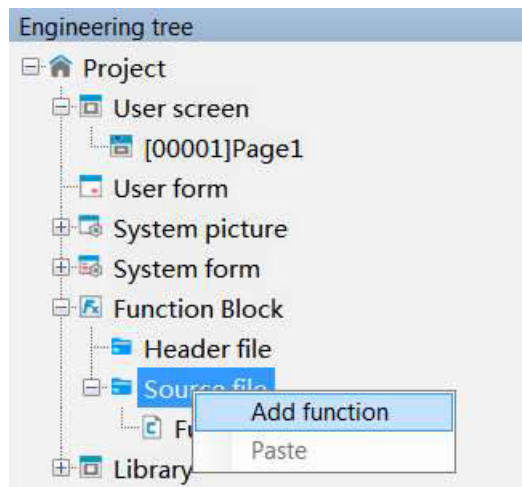

The function block information input box appears (as shown in the figure below), fill in the relevant information and click OK.

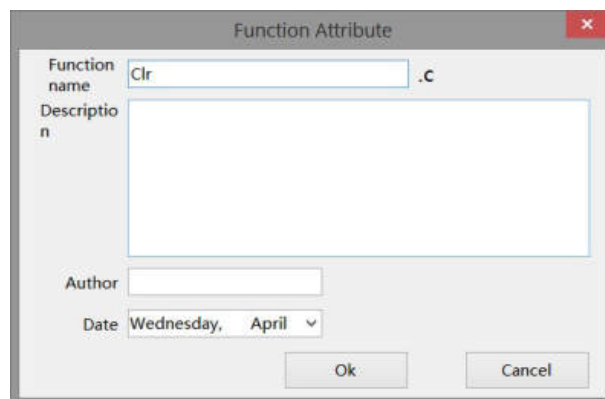

Establish a C function block editing environment, with the following functions:

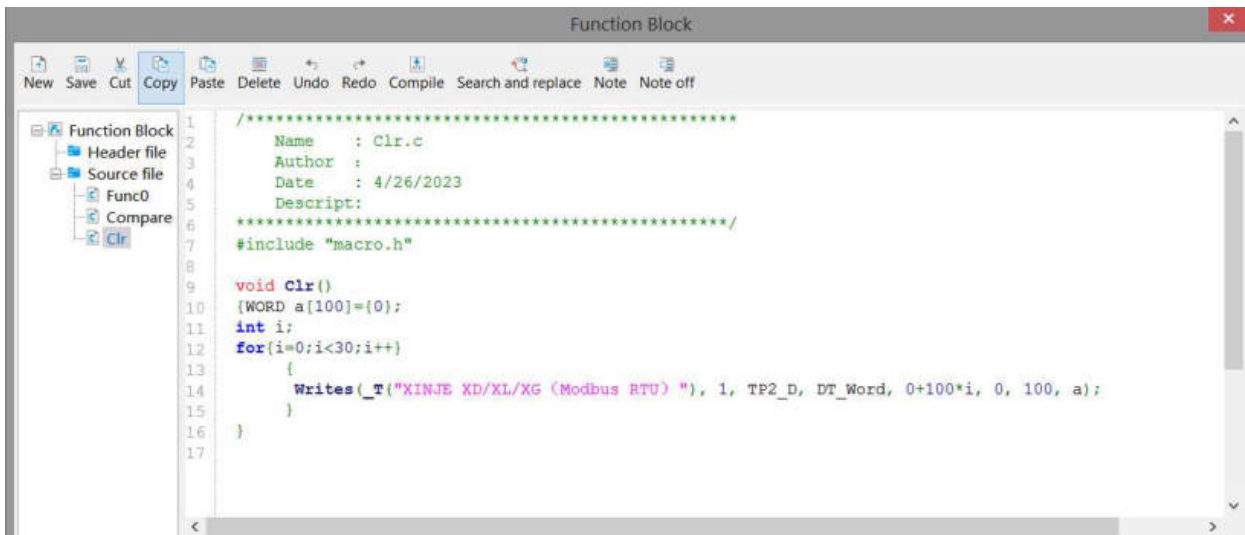

3. call the function

Place a function key on the screen, and the remaining settings are shown in the following figure. Select "Function Call" from the "Optional Functions" on the right, then click the "Add" button to add this function. Double click "Call Function" in the "Selected Functions" section, and select the name of the function to be called in the "Function" section (select the newly created function "Clr" above) to add the function.

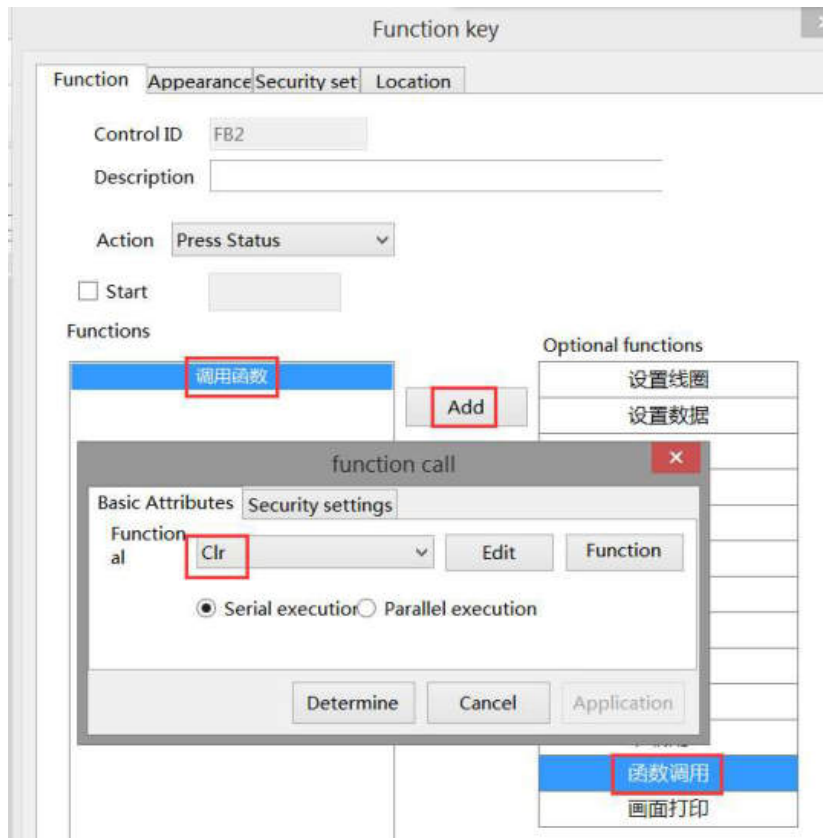

Click on the "Appearance" option, set the function key text to "Reset", and finally click "OK" to complete the settings.

4. Download the program to the HMI for operation.

6-3-3. Four arithmetic operations of floating point

Example requirements:

Perform addition, subtraction, multiplication, and division operations.

Example device:

- (1) One TS3-700-E
- (2) One USB download cable and one computer

Related information:

- (1) TouchWin Pro Editing Software User Manual

Operation process:

1. New project, screen content production

(1) Place two data input components on the screen, with their addresses set to PFW300 and PFW302, their attributes set to DWORD, floating point display (DWORD float), integer bits 3 and decimal bits 2. The settings are shown in the following figure (all other data input operations are the same):

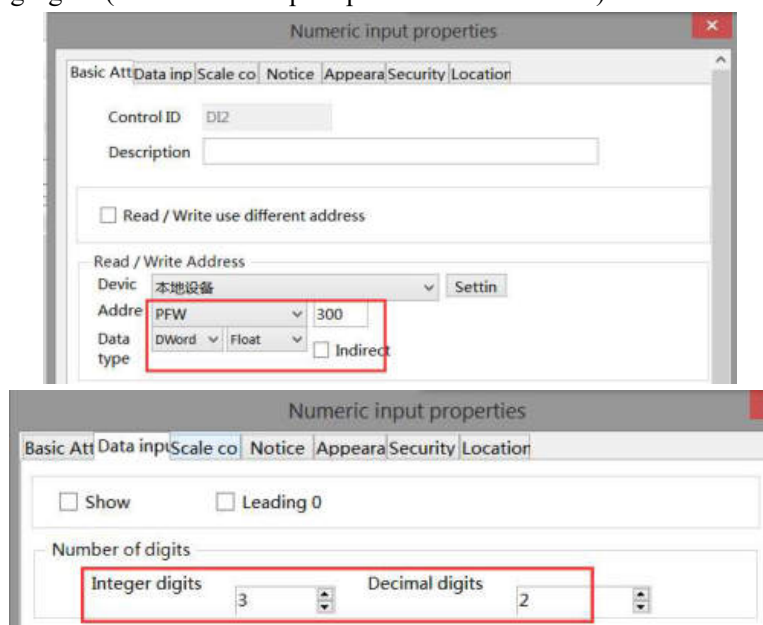

(2) Place four data display components on the screen, with addresses of PFW304, PFW306, PFW308, and PFW310. The attributes are all set to DWORD, floating point display (DWORD float), with 3 integer bits and 2 decimal bits. The settings are shown in the following figure (all other data display operations are the same):

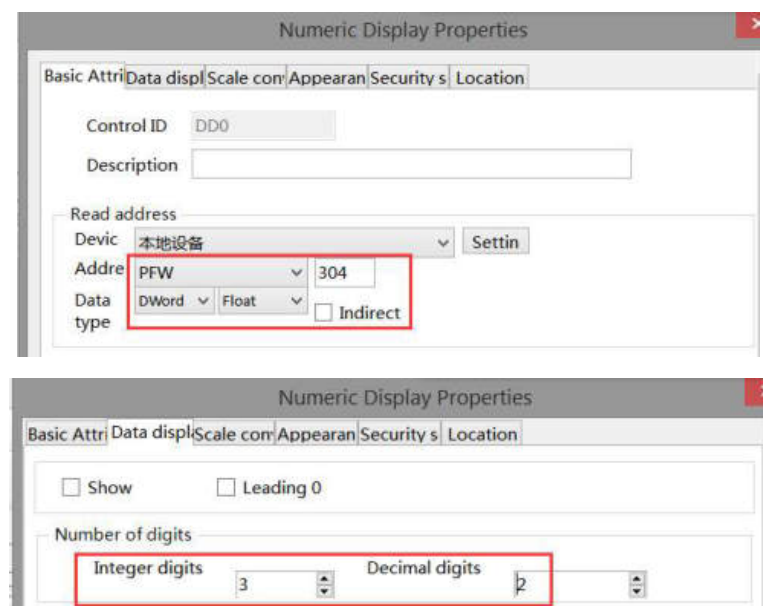

3. Establish C function block

In the Engineering Tree Function Block, right-click and select Add Function.

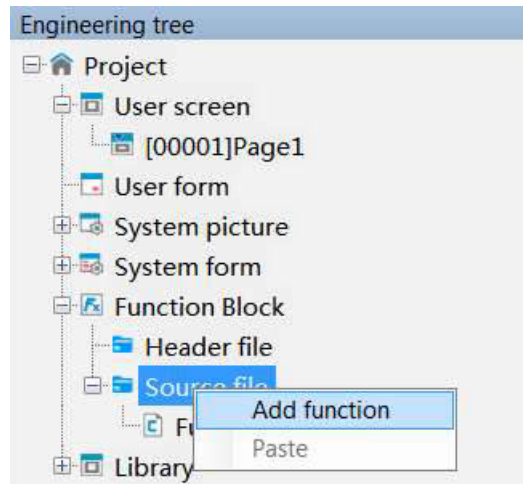

The function block information input box appears (as shown in the figure below), fill in the relevant information and click OK.

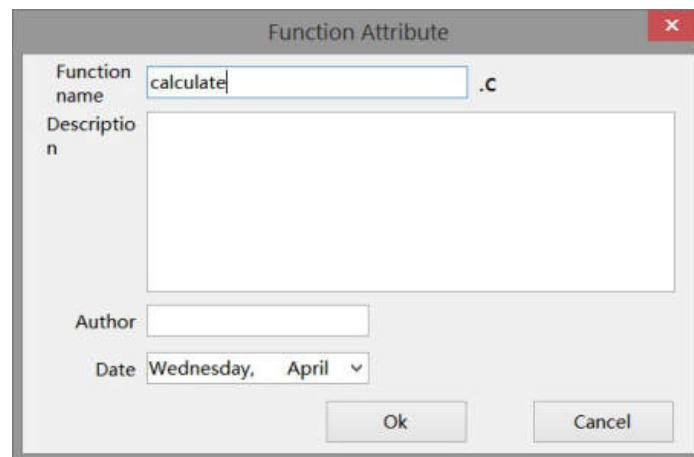

Establish a C function block editing environment, with the following functions:

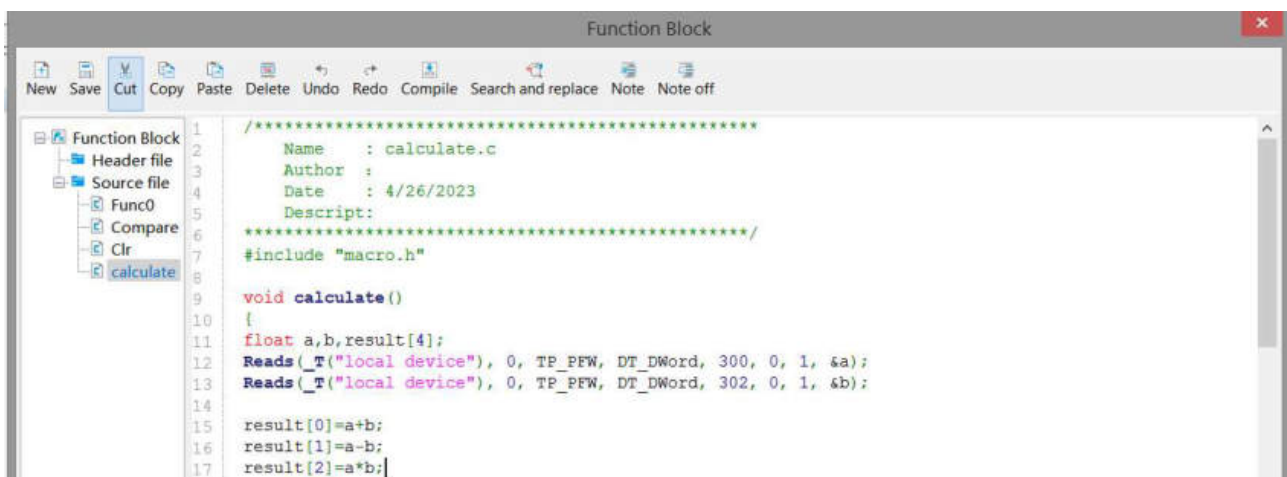

4. call the function

Place a function key on the screen, and the remaining settings are shown in the following figure. Select 'Function Call' from the 'Optional Functions' on the right, then click the 'Add' button to add this function. Double click on 'Call Function' in the 'Selected Functions' section, and select the name of the function to be called in the 'Functions' section (select the newly created function 'calculate' above) to add the function.

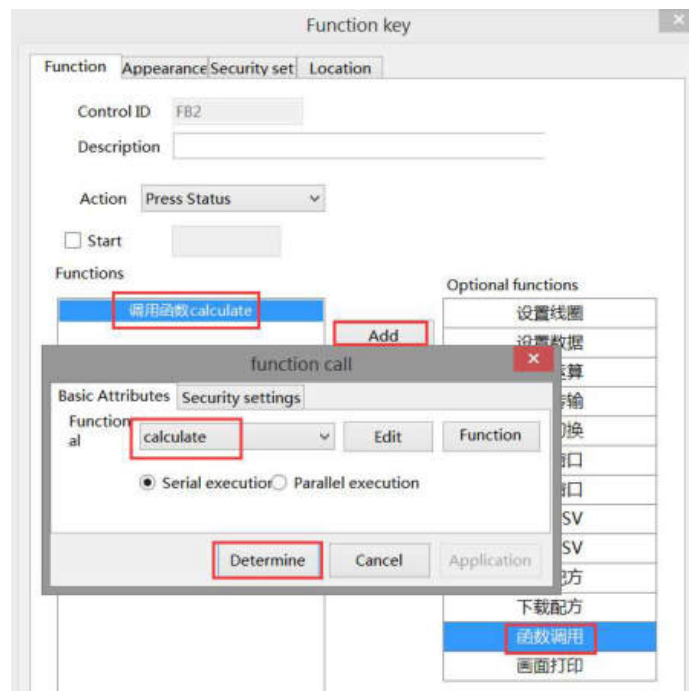

Click on the "Appearance" option, set the function key text to "Four operations", and finally click "OK" to complete the settings.

5. Download the program to the HMI for operation.

6-3-4. Data type cast

Example requirements:

It is mainly used to realize the forced conversion of data type through C function, where floating point is converted to integer, and integer is converted to floating point.

Example device:

- (1) One TS3-700-E
- (2) One USB download cable and one computer

Related information:

- (1) TouchWin Pro Editing Software User Manual

Operation process:

1. New project, screen content production

Place two data input components on the screen, with their addresses set to PFW300 and PFW400, and their attributes set to DWORD. The PFW300 data type is floating point (DWORD float), with 3 integer bits and 2 decimal bits. The PFW400 data type is set to unsigned numbers with 5 integer bits and 0 decimal places. Place a data display unit on the screen, with the address set to PFW500, the attribute set to DWORD, the data type floating point (DWORD float), integer bits 3 and decimal bits 2. The settings are shown in the following figure:

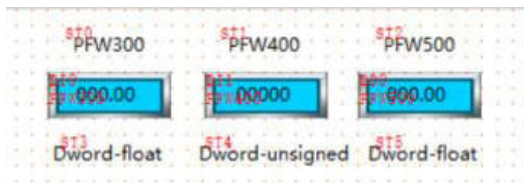

3. Establish C function block

In the Engineering Tree Function Block, right-click and select Add Function.

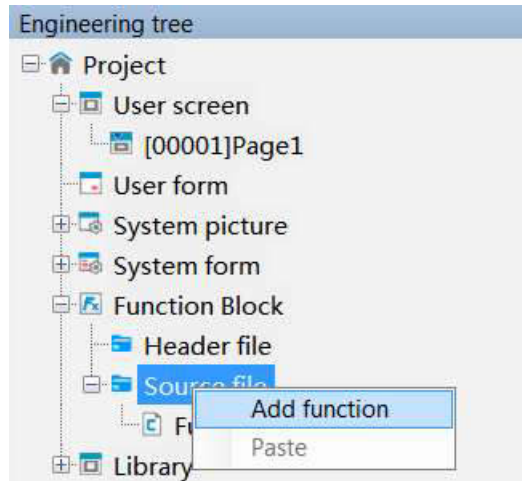

The function block information input box appears (as shown in the figure below), fill in the relevant information and click OK.

Establish a C function block editing environment, with the following function sections
Convert: cast a floating point number to an integer.

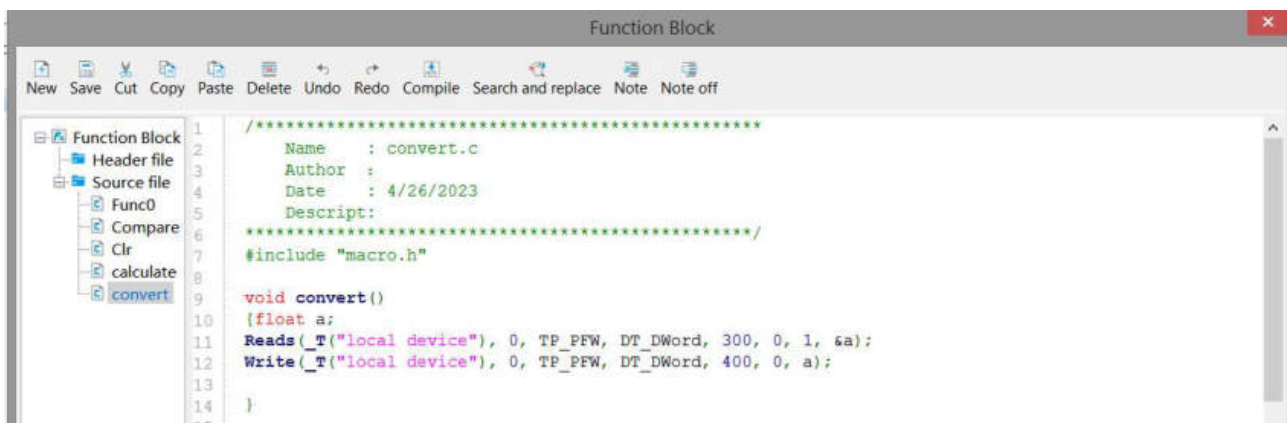

Convert1: Integer cast to floating point number.

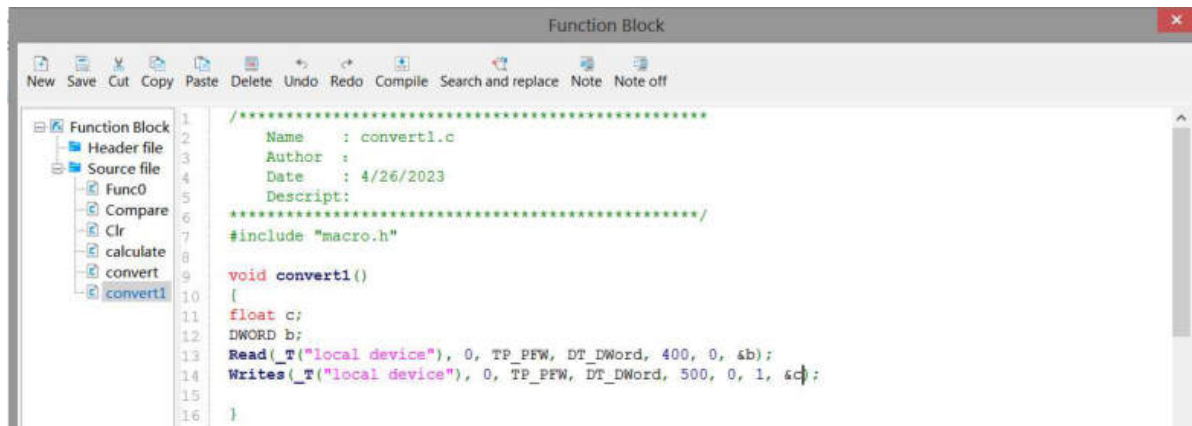

```
1  /*****
2  Name   : convert1.c
3  Author :
4  Date   : 4/26/2023
5  Descrip:
6  *****/
7  #include "macro.h"
8
9  void convert1()
10 {
11     float c;
12     DWORD b;
13     Read(_T("local device"), 0, TP_PFW, DT_DWord, 400, 0, &b);
14     Writes(_T("local device"), 0, TP_PFW, DT_DWord, 500, 0, 1, &c);
15
16 }
```

4. call the functions

Place a function key on the screen, and the remaining settings are shown in the following figure. Select "Function Call" from the "Optional Functions" on the right, then click the "Add" button to add this function. Double click on "Call Function" in the "Selected Functions" section, and select the name of the function to be called in the "Functions" section (select the newly created function "convert1" above) to add the function.

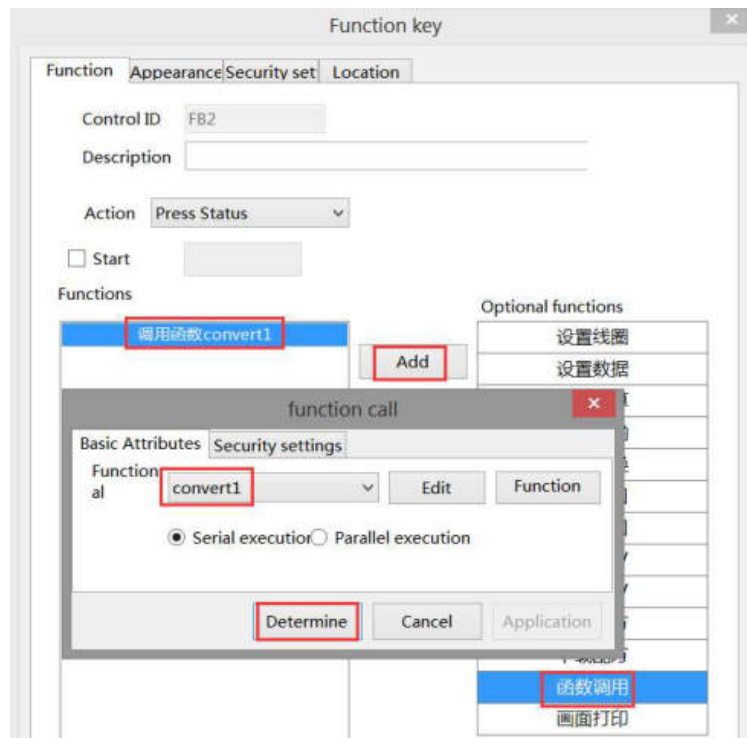





Click the "Appearance" option, set the function key text to "floating point>Integer", and finally click "OK" to complete the setting.

Create another function key, the operation is the same as above, call the function "convert", and the text is "integer>floating point number".

5. Download the program to the touch screen for operation.

7. HMI system settings

7-1. System setting introduction

This function is to modify and display the system parameters of the HMI. After downloading the project, it will be displayed in the bottom right corner of the touch screen by default. Clicking on the "" setting icon will display the default hidden "" icon, which includes system settings, keyboard, and device information from left to right. If you do not need this function, you can hide it by checking the "Hide System Menu" on the project download page. The setting icon will not appear in the bottom right corner of the touch screen (after checking hide, you need to download the project).

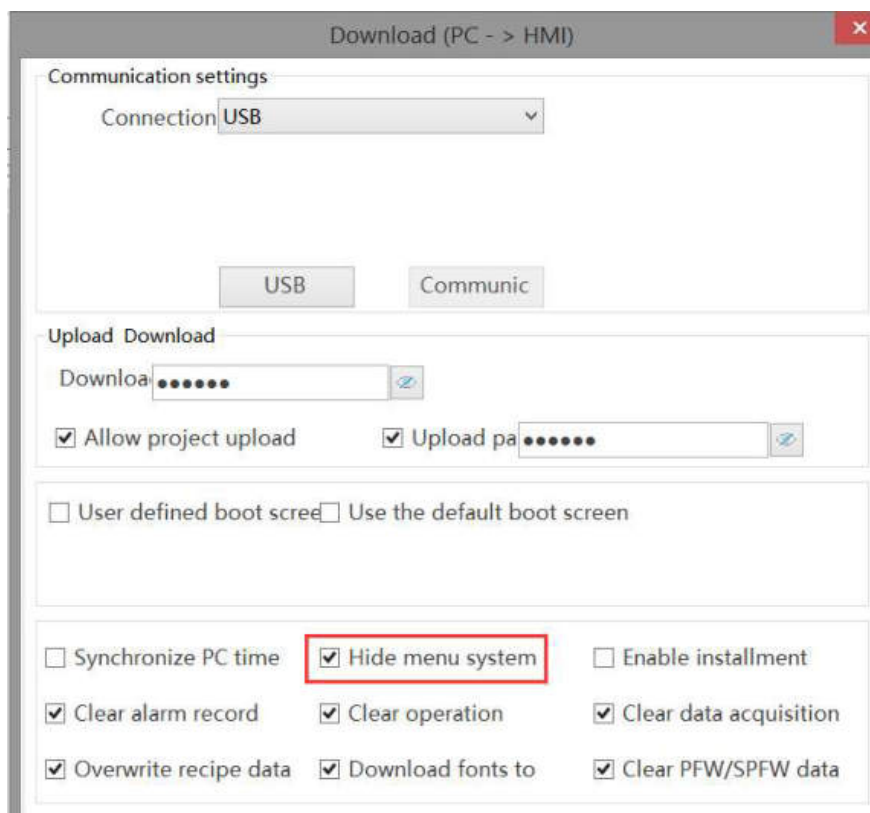

7-2. Keyboard

Click on the "" icon to pop up the keyboard, which serves as the input keyboard for modifying system parameters on the touch screen and can also be used as the input keyboard for registers.

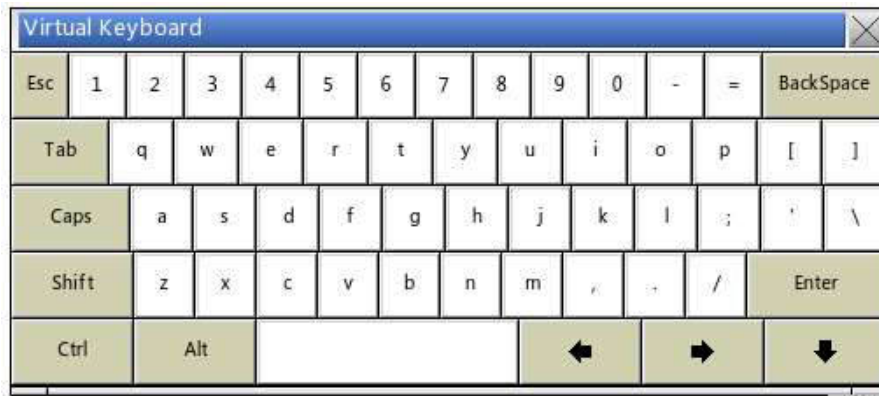

7-3. Device information



Click the  icon to display a device information pop-up window, which includes HMI version, download version, system version, device IP, and device ID.

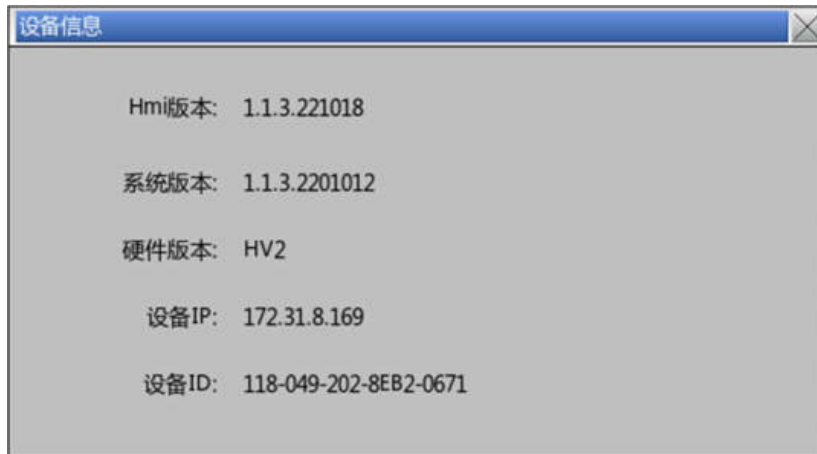

7-4. Setting



Click  to pop up the 'Please Enter Password' pop-up window, where you can enter the 'Set Password' (default initial password 123456, which can be customized on the chapter 7-2 password setting page) and enter the setting interface. There are 7 pages under the settings interface, from left to right: name, password, network, time, VNC, system, and others.

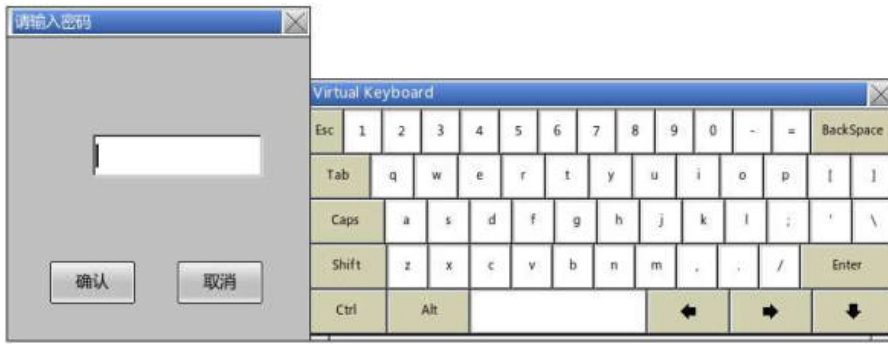

7-4-1. Name

Click on "Name" to enter, click on the "Modify" button on this page to modify the name of this HMI. After entering the name, click "Confirm" to save it.



When the modified name is downloaded through the local area network on the download page, scan the IP to display the corresponding name.

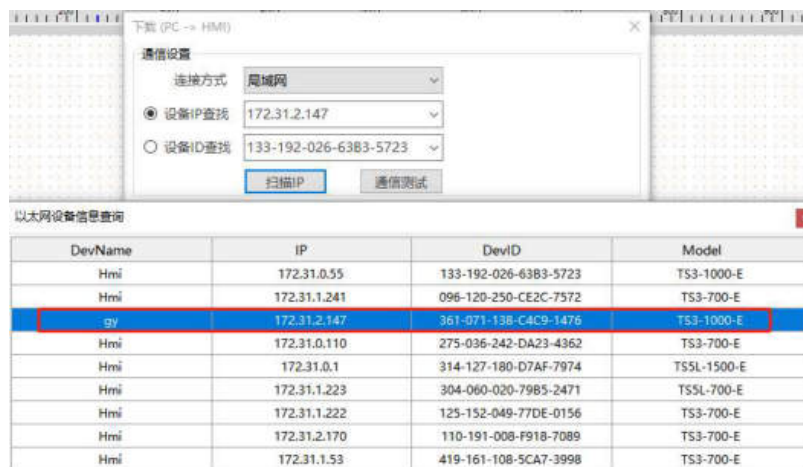

7-4-2. Password

Click "Password" to enter, where you can modify the upload password, download password, set password, and VNC password. To modify the password, you need to enter the original password, and the system default password is "12345678".



<p>change upload password</p>	<p>This function is used to modify the upload password of the corresponding project.</p> <p>If the upload password is set in the software before downloading the project, and is modified on the touch screen after downloading the project, the corresponding password when uploading the project is the modified password.</p> <p>If the upload password is set before downloading the project and is not modified on the touch screen after downloading the project, the upload password remains the password set in the software before downloading the project, and the upload password can be blank.</p> <p>If the input upload password does not correspond to the set password, the download page will prompt for an incorrect command password. For the specific operation steps of the project upload function, please refer to chapter 2-6 Upload Project</p>
<p>change download password</p>	<p>The download password is used for the download interface and can only be modified through the password setting interface in the HMI settings. After modifying the download password, the corresponding password on the download page during project download is the modified password, and the download password cannot be empty. If the entered download password does not correspond to the set password, the download page will prompt "Command password error". Please refer to chapter 2-5 project download for the specific operation steps of the engineering download function</p>
<p>change setting password</p>	<p>This function is used to modify the password for entering HMI settings. After modifying the setting password, the corresponding password when entering the settings is the modified password. If the entered setting password is incorrect, the HMI page will pop up a "Password Incorrect" pop-up window. The HMI settings interface can only be accessed by entering the correct setting password.</p>
<p>change VNC password</p>	<p>This function is used to modify the password when VNC connects to the HMI the next time.</p>
<p>change remote password</p>	<p>This function is used to modify the password when connecting to the HMI remotely the next time. The modified password requires a HMI restart to take effect</p>

7-4-3. Network

Click "Network" to enter, where you can modify the IP address of the HMI. You can choose to automatically obtain the IP address through DHCP or manually set the IP address. If an IP address is set in the project, the IP displayed on this page after downloading the project is the IP set by the project.



7-4-4. Time

Click "Time" to enter. On this page, you can modify the display time of the HMI. If you want to set the time, you need to remove the default "Disable Clock Setting" check from the system clock setting page in the project. Then you can download the project to the HMI and modify the time on this page.

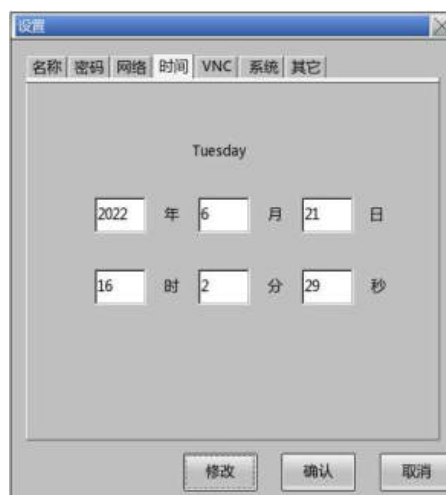
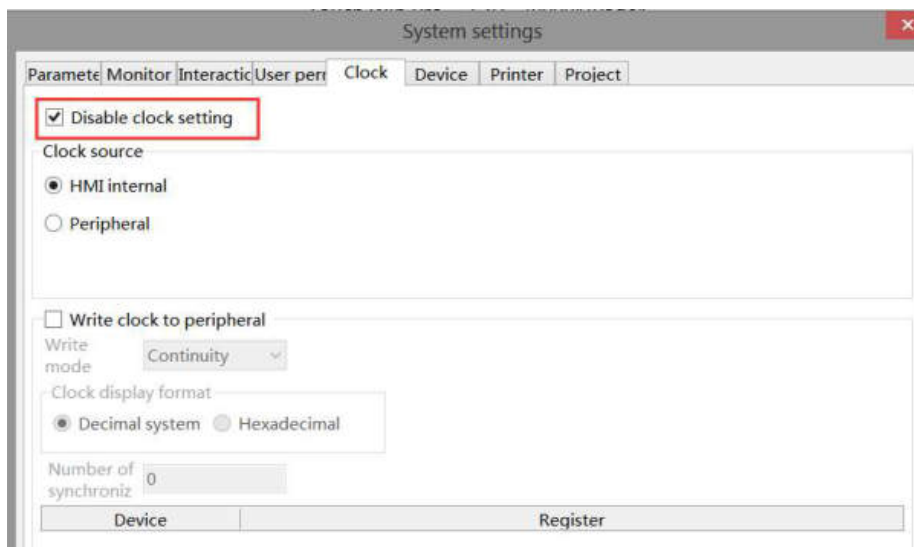

7-4-5. VNC

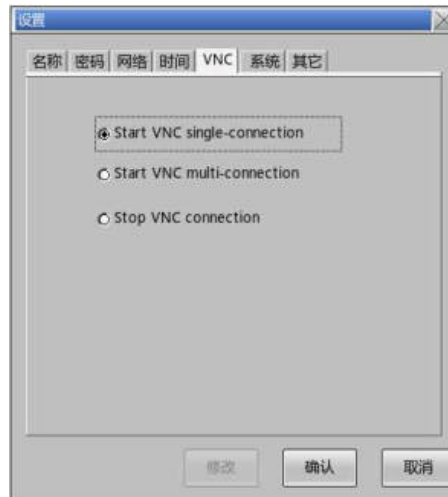

VNC connection supports two connection methods: one is the information configuration entry within TS software. The other type is an external VNC Viewer.

<input checked="" type="radio"/> Start VNC single-connection	<p>Only a single VNC can be enabled, that is, only one VNC entry can be enabled to connect to this HMI. If an external VNC Viewer is enabled, priority should be given to connecting to the VNC configured internally in the software, and the settings will take effect synchronously.</p>
<input type="radio"/> Start VNC multi-connection	<p>Support multiple VNC usage, that is, multiple VNC entries are enabled simultaneously to connect to this HMI, and synchronization takes effect after setting.</p>
<input type="radio"/> Stop VNC connection	<p>Close VNC connection, that is, other VNC ports cannot enable VNC connection to this HMI. After setting, synchronization will take effect.</p>

7-4-6. System

Click "System" to enter, where you can view system information and the proportion of system resources.

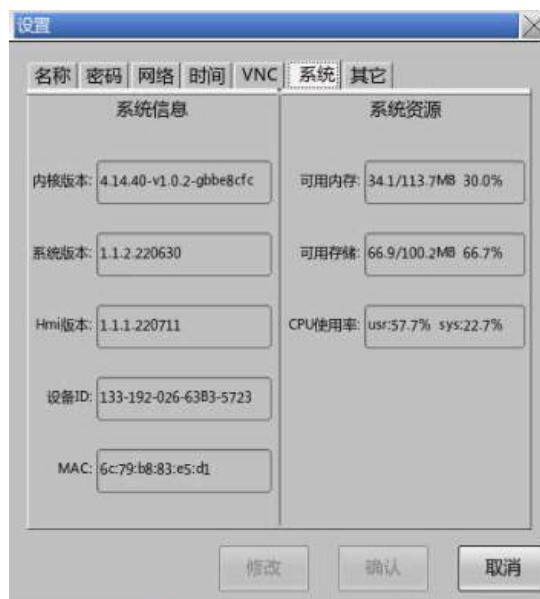

7-5. System menu

Under the system menu, touch calibration, firmware updates, and viewing and modifying partial system information of the HMI can be performed, including local information, time, IP, password, and information functions. At the same time, all screens serve as system menus and can be called up in user project.

■ Enter mode

If the hardware version of the HMI is H1, in the event of a power outage, turn the 3rd dial switch on the back of the HMI to ON and then power on to enter the system menu; If the hardware version of the HMI is H2 or above, you need to first hold down any position of the touch screen, then power on the HMI to enter the system menu

■ Function description

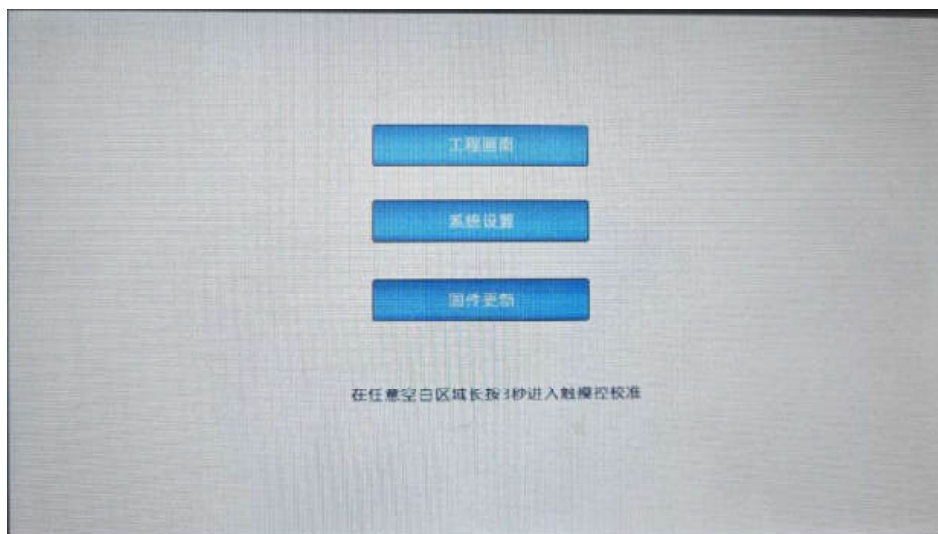

Project screen	Click to directly enter the project editing screen.
System setting	After clicking this button, you can enter the touch screen system settings screen, where you can view or modify the internal settings of the touch screen, including the local information, time, IP, password, and information related functions of the HMI. In the following sections, a detailed explanation of this feature will be provided.
Firmware update	Used to update HMI firmware.
Touch calibration	When there is a deviation in the touch, this function can be used for calibration. Press and hold for 3 seconds in any blank area to enter the calibration screen



The information function is only supported by the TS5 series HMI.

7-5-1. Native information

After clicking the "System Settings" button, you will enter the screen shown in the following figure. Under this function, you can view and modify the local information, time settings, HMI IP settings, and password settings of the touch screen. The TS5 series has an additional information settings page, which can be switched through the left button. Click the "Home" button in the upper left corner to return to the startup page of the project screen.

In the local information, you can view the local model, module model, HMI version, system version, hardware version, local IP, local ID, available memory, and available storage.



7-5-2. Time setting

The time setting page allows you to view and modify the current date, time, and week.



If you need to change the date, you can click the "Modify" button in the bottom right corner to directly modify the sub items that need to be corrected. After modification, click "Confirm" and the page will prompt the modification result; If you click the "Cancel" button, the modified content will not be saved.



7-5-3. HMI IP setting

The IP settings page allows you to view and modify the IP acquisition method and IP address related information of the HMI.



Under the condition of manually setting the IP address, after changing the IP address, click "OK" to save, and the page will pop up with the modification result; If you click the "Cancel" button, the modified content will not be saved.



7-5-4. Password setting

The password setting page is used to modify the upload password, download password, and set password of the HMI. If you need to modify the password, you can directly enter the original password, new password, and confirm the new password in the input box under the corresponding category. After entering all three, click "Modify" and the page will prompt you with the modification result.



Kind reminder: Please remember your password information. If you forget it, you will not be able to retrieve it.

7-5-5. Informatization settings

The TS5 series products support the IoT function, which can be viewed and switched through the "Information Settings" page, including internet access and password changes. Due to the impact of information technology related function settings on HMI networking, it is necessary to verify the information technology password, which is the remote password of the HMI. The default password at the factory is 12345678.



After successfully entering the password, you can enter the relevant information configuration page. The homepage allows you to view information related to information technology, such as the current device's networking method, signal strength, SIM card status, and remote related flag status.



Networking method	Display the current networking status of the HMI. The information on networking methods includes: wired, WiFi, 4G, and not connected.
Signal strength	Display the signal strength in 4G or WiFi mode, with a value of -99~0. The closer to 0, the stronger the signal. In wired mode, the signal strength is displayed as 0.
SIM card status	Display the status of the SIM card in 4G internet mode. The SIM card status includes six different states: network normal, SIM card detected, successful network login, internet failure, SIM card detected, network login failure, internet failure, SIM card not detected, error, and 4G module not inserted.
Remote login flag	Display the current remote login status of the device. This includes two states: logged in and not logged in.
VNC enable flag	Display the current VNC enabled status of the device. Including two states: enabled and not enabled.
MQTT service flag	Display the current MQTT service status of the device. This includes two states: logged in and not logged in.
Xinje Cloud QR code	The three QR codes are the QR codes for Cloud webpage, APP download, and WeChat mini program, which can be scanned and recognized with a mobile phone. Through cloud platform, remote operations such as VNC and data transmission can be performed on touch screens.
Information password modification	Click "Information Password Modification" to enter the password modification page as shown in the following figure. On this page, you can modify the VNC password and remote password of the HMI. 
Modify	Note: After changing the remote password, it must be restarted the HMI to take effect. Click the "Modify" button to enter the network configuration viewing and configuration page. If the networking method has been configured, the current networking method page

will be displayed upon entering; If the internet connection method is not configured, the wired internet connection page will be displayed.

You can switch the networking mode through the dropdown menu in the upper left corner of the "Networking Mode" and make corresponding networking configurations. The following will provide a detailed introduction to three different networking mode configurations.



Return

Click to exit the information settings and return to the system page.

(1) Wired networking

The wired internet configuration page is shown below, and you can choose to automatically obtain an IP address through DHCP or manually set an IP address according to your needs. After setting up, click "Confirm" to save. If you click the "Back" button during the setup process, all changes to the current page will not be saved.

IP地址	10	100	19	55
子网掩码	255	255	255	0
默认网关	10	100	19	254
DNS	10	100	2	10

(2) WiFi networking

Under WiFi internet connection mode, it is necessary to configure the WiFi for internet connection, as shown in the following figure.

SSID	安全	信号强度
Xinje AP	WPA_WPA2_PSK	-65
xinxihua	WPA_WPA2_PSK	-77
xinje	WPA2_PSK	-85
TP-LINK_2108E8	NONE	-87
DIRECT-C6-HP Laser 136w	WPA2_PSK	-87

The page will display 12 WiFi networks that can be selected in a table, divided into two pages with 6 rows displayed on each page. You can switch between the "Previous" and "Next" buttons on the right side. Currently, automatic refresh is not supported. To refresh, you can click the "Refresh" button on the right.

If you need to configure or switch to connected WiFi, you can click on the row where the target WiFi is located. A password prompt will appear above the table and below the networking method. After entering the correct password in the input box, the touch screen will try to connect to WiFi. If the connection is successful, the SSID of the WiFi will be displayed in the "Currently Connected to WiFi" section at the top right of the page, and it will be used to connect to the network.



(3) 4G networking

No other settings are required in 4G internet mode. After selecting the 4G internet mode, click "Confirm" to proceed.

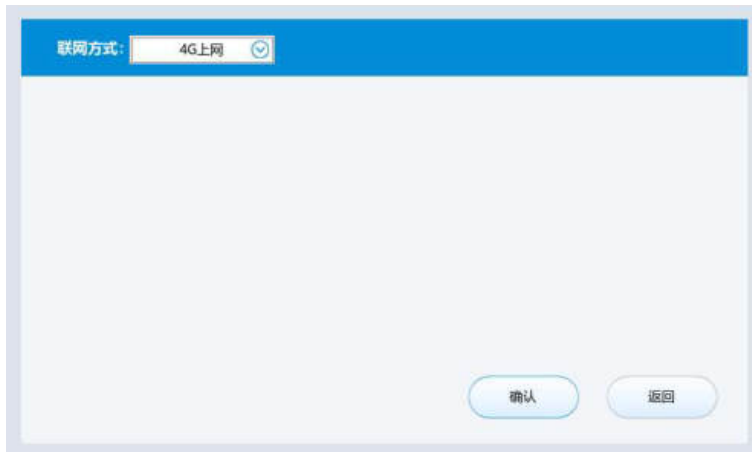

8. Informationization settings

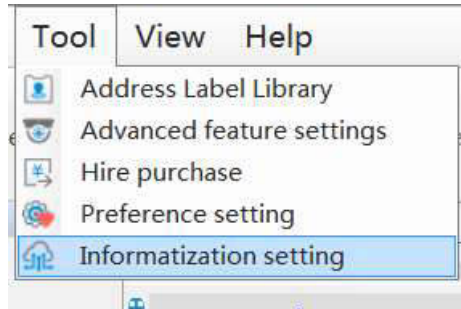

8-1. Information configuration login

1. Click on the menu bar - Tools - Informatization Setting to enter the Informatization Configuration interface

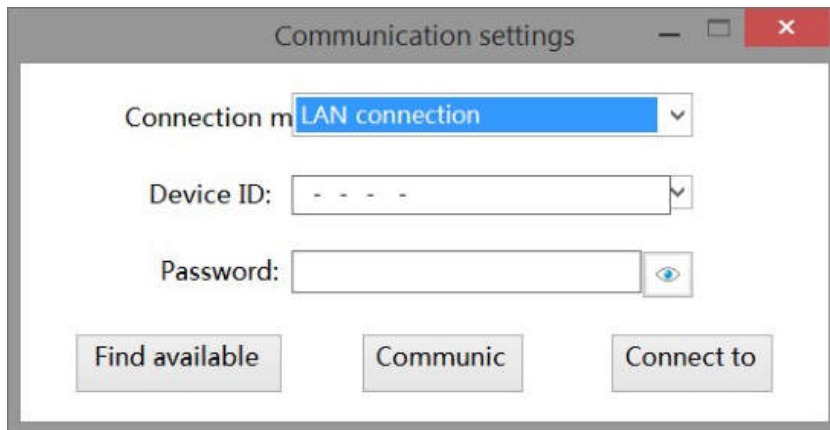

2. Information communication settings interface

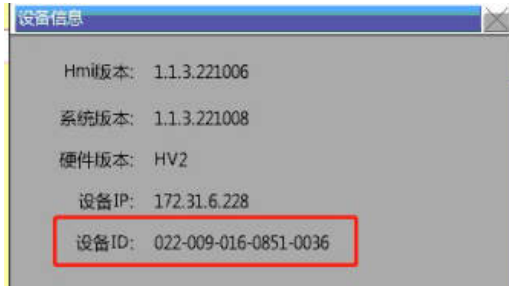

connection mode	LAN connection and remote connection
device ID	<p>Enter the ID number of the connected HMI, or select the last entered ID number through the dropdown box</p> <p>Each HMI has a unique device ID, there are four methods to query the device ID.</p> <ol style="list-style-type: none"> 1. You can click on the system settings button in the bottom right corner of the touch screen “”, select “”. At this time, a device information box will pop up, indicating the device ID number.  <ol style="list-style-type: none"> 2. Check the device ID number on the nameplate on the back of the HMI.



3. When downloading, select the LAN download and scan the IP interface to find the required device ID based on the model and IP address.

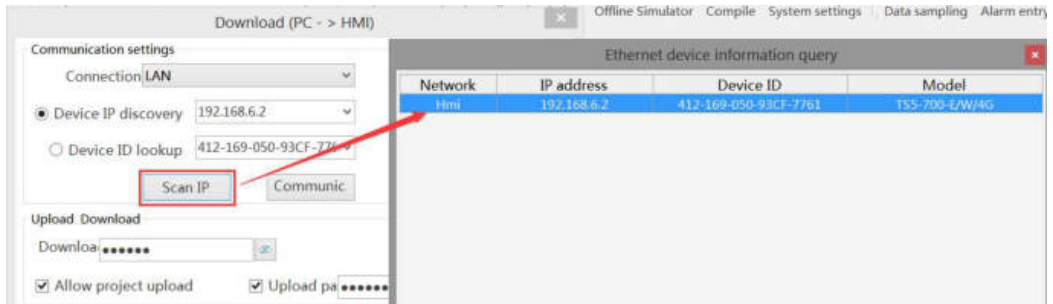

4. See the description of 'Find Available Devices' below

password

default password: 12345678 (user can define the password, refer to chapter 7-3-2 password)

find available device

When the device ID address is uncertain or multiple touch screens are connected, you can click this button to scan the device IP that the computer is connected to. Select the IP address that needs to be connected from the scanned IP address, click "Find Available Devices", and the following pop-up window will pop up. Double click to select the device you want to connect to

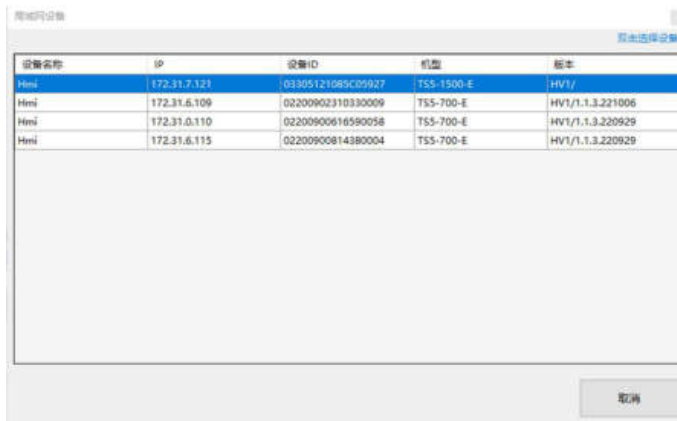

communication test

Used to test whether the HMI is successfully connected to the computer. After clicking, a prompt box will pop up displaying whether the connection was successful or failed

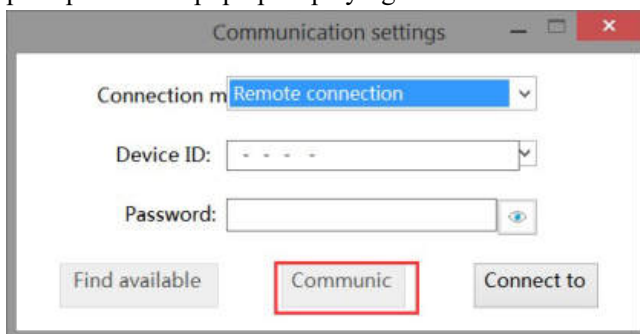

connect to the device

After entering the correct device ID and password, click "Connect to the Device" to successfully log in to the information configuration interface



- 1. When connecting to a local area network, the HMI IP and the computer IP must be in the same network segment.** When selecting the LAN connection method, it is necessary to enter the correct ID number and password; Alternatively, by clicking to find available devices, double-click to select the device you want to connect to (the default connection password is 12345678).
- 2. Before using the information function for the first time, the HMI must contain a program. When making remote connections for the first time, it must be connected through a local area network.** After entering the information configuration interface, different internet access methods (4g/wifi) should be selected based on the modules behind the HMI. For specific usage methods, please refer to 2-3 internet access methods. After successful configuration, enter the device ID number and remote connection password to successfully connect remotely.
3. The information function can also be used when the project is not open. Select LAN or remote connection, and only after successful connection can you enter the configuration page. When modifying information configuration, it is necessary to maintain the connection between HMI and PC.

8-2. State information

View the currently mounted modules and system information:

Informatizati ○ - X

Status information Networking settings Remote settings Online transmission Data release

Module information: None

Module version: V1.0

Name	Register	Value	Notes
Networking mode	SPSW56	3	Single word Dec integer
Signal intensity	SPSW57	0	Single word Dec integer
System time	SPSW16	2023-05-06 11:5:7	Six word Dec integer
device running time	SPSW200	00:28:18	Triword decimal integer
IP address	SPSW58	192.168.6.2	Quadword Dec integer
Subnet mask	SPSW62	255.255.255.0	Quadword Dec integer
Gateway	SPSW66	192.168.6.1	Quadword Dec integer
DNS	SPSW71	0.0.0.0	Quadword Dec integer
MAC address	SPSW75	3C-47-57-07-75-FF	Six word Hex integer
VNC Service Enable Fl...	SPSB22	1	Bit, binary
MQTT server enable fl...	SPSB19	0	Bit, binary
LAN connection sign	SPSB23	1	Bit, binary
Login server flag	SPSB20	1	Bit, binary

Module information	Display the current module name, wired/4G/WiFi
Module version	Display the current module version
Networking mode	1: 4G 2: WiFi 3: wired
Signal intensity	Effective in 4G and WiFi modes, displaying signal strength (-51dB~-113dB) The signal greater than -51 is strongest, and the signal less than -113 is weakest The closer the value is to 0, the stronger the signal strength
System time	Display the current system time
Device running time	Accumulated time of operation after starting the device
IP address	Display the IP address obtained by the current device
Subnet mask	Displays the subnet mask obtained by the current device
Gateway	Display the gateway address obtained by the current device
DNS	Displays the Domain Name System server address obtained by the current device
MAC address	MAC address
VNC service enable flag	Monitor whether VNC server is enabled in HMI 1: ON 0: OFF
MQTT service enable flag	Monitor whether MQTT server is enabled in HMI 1: ON 0: OFF
LAN connection flag	1: ON 0: OFF
Login server flag	Monitor whether HMI is connected to FRP server 1: ON 0: OFF We suggest to use this flag bit to monitor if the HMI is in remote status.



This page displays the corresponding status information and system registers of the module, which can only be viewed and cannot be modified.

8-3. Networking settings

8-3-1. TouchwinPro software configuration

You can set the internet access method here: 4G, WiFi, or wired mode:

The screenshot shows a window titled 'Informatizati' with several tabs: 'Status information', 'Networking settings', 'Remote settings', 'Online transmission', and 'Data release'. The 'Networking settings' tab is active. Under 'Networking mode', a dropdown menu is set to 'Wired Internet Access'. There are two radio button options: 'Get address automatically' (selected) and 'Use the following address'. Below the second option, there are input fields for 'IP address' (192 . 168 . 6 . 10), 'Subnet mask' (255 . 255 . 255 . 0), and 'Default Gateway' (192 . 168 . 6 . 1). Another set of radio buttons includes 'Get server address automatically' (selected) and 'Use the following server address'. Below this, there is a 'Preferred DNS Server' input field with the value 0 . 0 . 0 . 0. At the bottom of the window are three buttons: 'Application', 'Ok', and 'Cancel'.

4G	When selecting 4G internet access, there is no need to configure parameters. After selecting 4G internet access, click "Application" below, and a pop-up window will prompt you to restart the HMI. After clicking "OK", restart the HMI, and the configuration parameters will take effect. Next time, remote login information configuration interface can be used
WIFI	When selecting WIFI to access the internet, users can manually enter their SSID and wireless password, or click on the WiFi scan button to view the SSID, encryption method, and signal strength of nearby devices. Click on Connect and enter the correct WiFi password. If the connection is normal, the parameter values will be automatically filled in to the parameter page 1-directly enter wifi name and password. Note: The password and name must be entered correctly, otherwise it may cause incorrect WiFi configuration to be downloaded and remote connections will not be able to log in. If this situation occurs, it is necessary to connect through the local area network and reconfigure the WiFi.

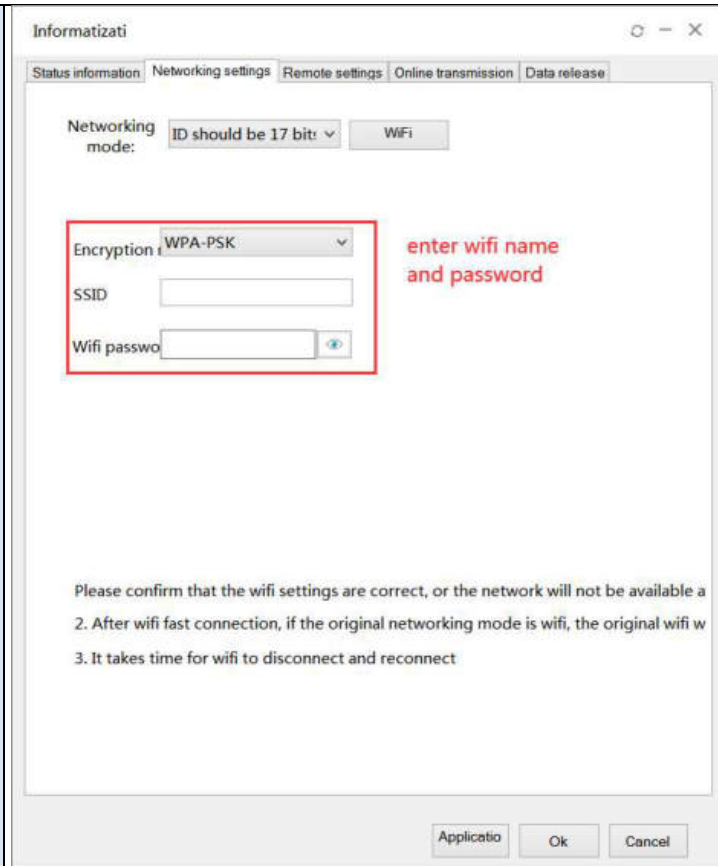

2-scan the parameters through wifi.

Step 1: Click on "WiFi Scan"

Step 2: Click the "Quick Connect" button

Step 3: Enter the corresponding WiFi password in the pop-up prompt box. If the password is entered correctly, there will be a prompt of "Connection Successful", otherwise there will be a prompt of "Connection Failed"

Step 4: After successful connection, click the "OK" button, display "Download successful". The configuration parameters will take effect and remote connection can be made

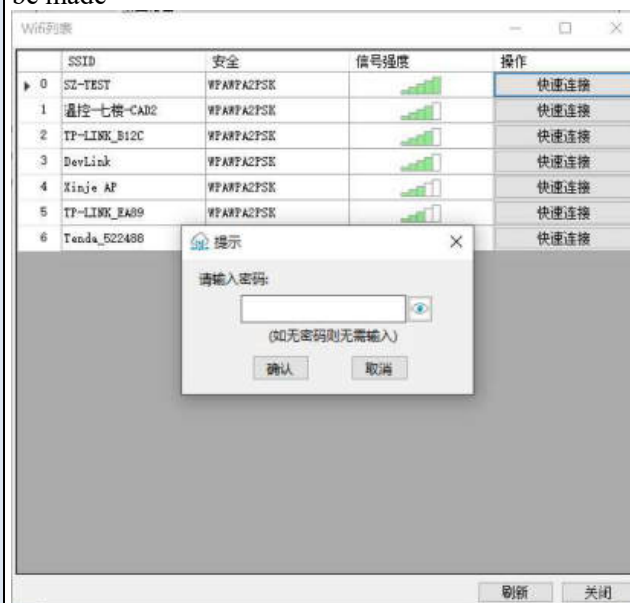

wired

When selecting wired Internet access, users can configure to obtain IP automatically, or manually set Internet access parameters, including IP address, subnet mask, default



1. The settings on this page will take effect after downloading the program and power on the HMI again.
2. If switching the internet mode causes the HMI to be unable to connect, please use Ethernet to connect to the local area network and reset the information settings.
3. Clicking the "OK" button will update all page configuration information to the lower computer(HMI). Please make sure to check each page before clicking "OK".

Whether each item of information on a page is incorrect, such as WiFi name, WiFi password, data publishing, etc; If only one page is changed or uncertain about the information, it suggests clicking the "Application" button, which will only update the current page configuration to the HMI.

8-3-2. HMI (lower computer) configuration

It supports configure through the HMI (lower computer), please refer to chapter 7-5-5 informatization setting.

8-3-3. User project configuration

Support information settings in the user project. The current information settings are set using the system template. Users can call relevant screens in the user project according to their needs, or transplant the relevant settings in the template to the user project. The current supported screens are as follows:

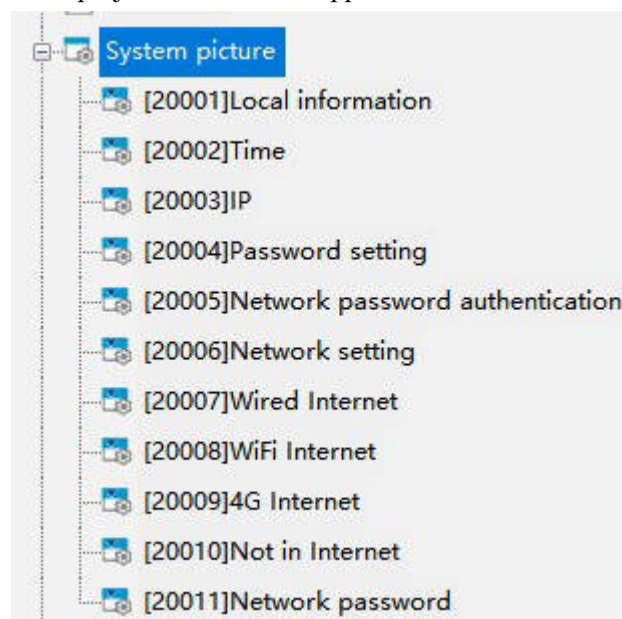

8-4. Remote settings (VNC)

The VNC function is a remote desktop function that can operate the HMI directly through a local area network or remote connection without the need for secondary configuration.

8-4-1. TouchwinPro software connection

TouchwinPro software is mainly used for single device maintenance and remote viewing. Generally, related operations are performed with a known ID, and click remote settings when it is already remote login through informatization settings.

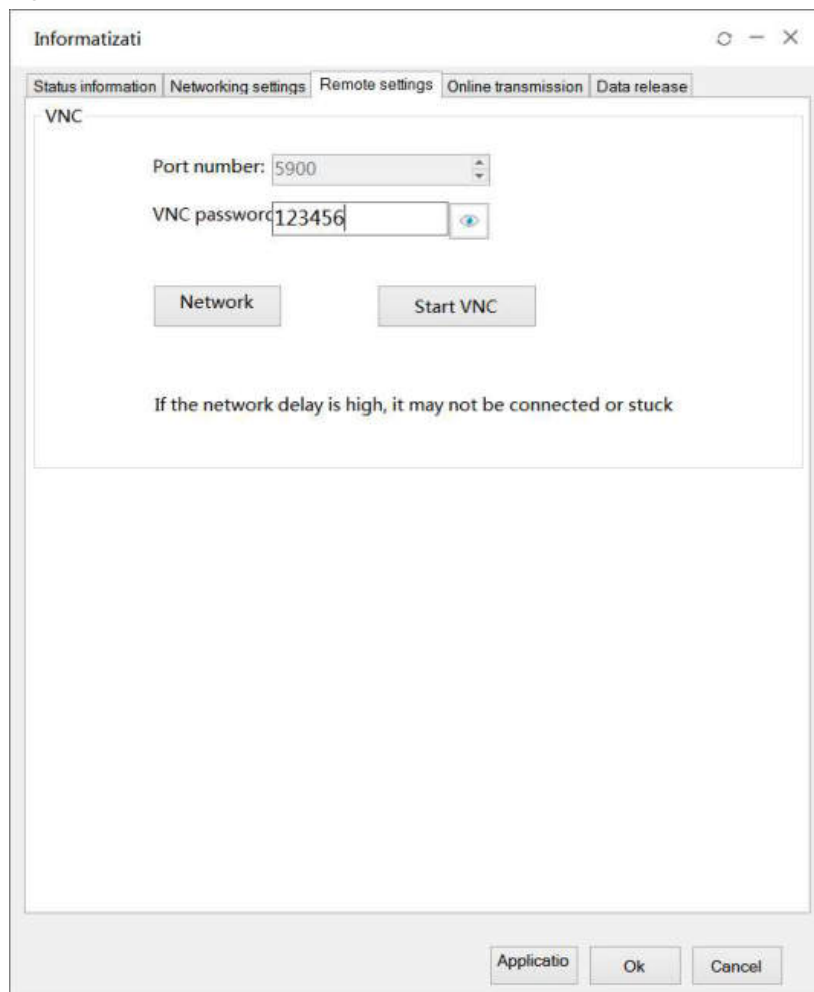

Port number	The default is 5900 and cannot be modified
VNC password	The default password is 123456 (customizable password, refer to chapter 7-3-2 password)
Network detection	After clicking on network detection, an attempt will be made to establish an Frp connection with the HMI, reporting the connection status and whether the connection is normal or abnormal
Start VNC	Open the local VNC client when clicking to start VNC
Stop VNC	Close the local VNC client when clicking to stop VNC



Note: If the network latency is high, VNC may not be able to connect or get stuck.

8-4-2. Boxmanger software connection

The Boxmanger software is mainly suitable for managing multiple devices, and can manage model devices through accounts. At the same time, using the Xinje IoT card can synchronize card management.

- (1) Boxmanger account and group setting
Refer to A-BOX user manual.
- (2) Right click on the group, select add device.

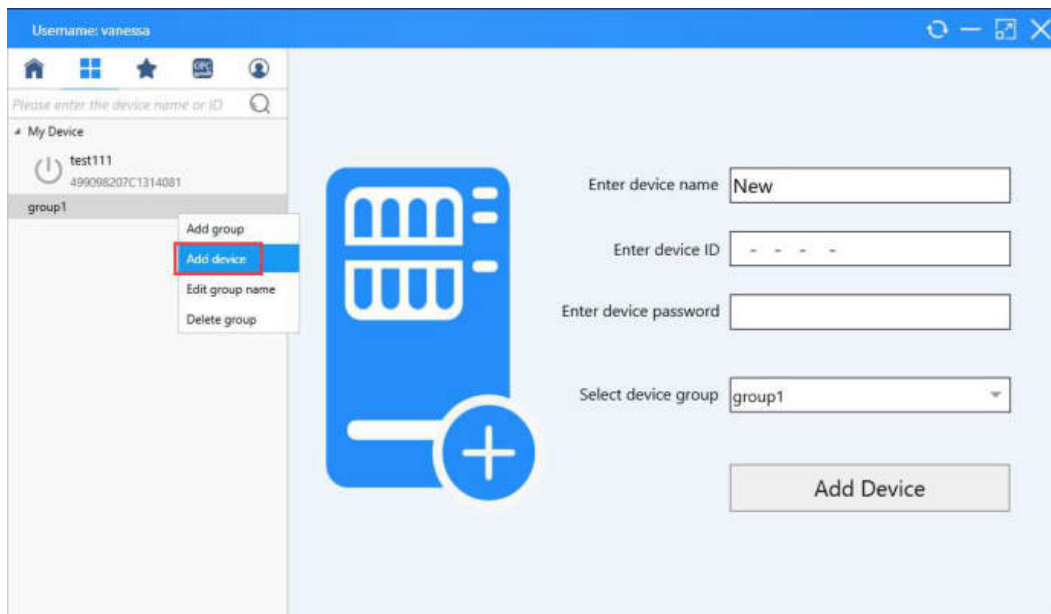

- (3) Enter the device ID and password, finish the configuration.

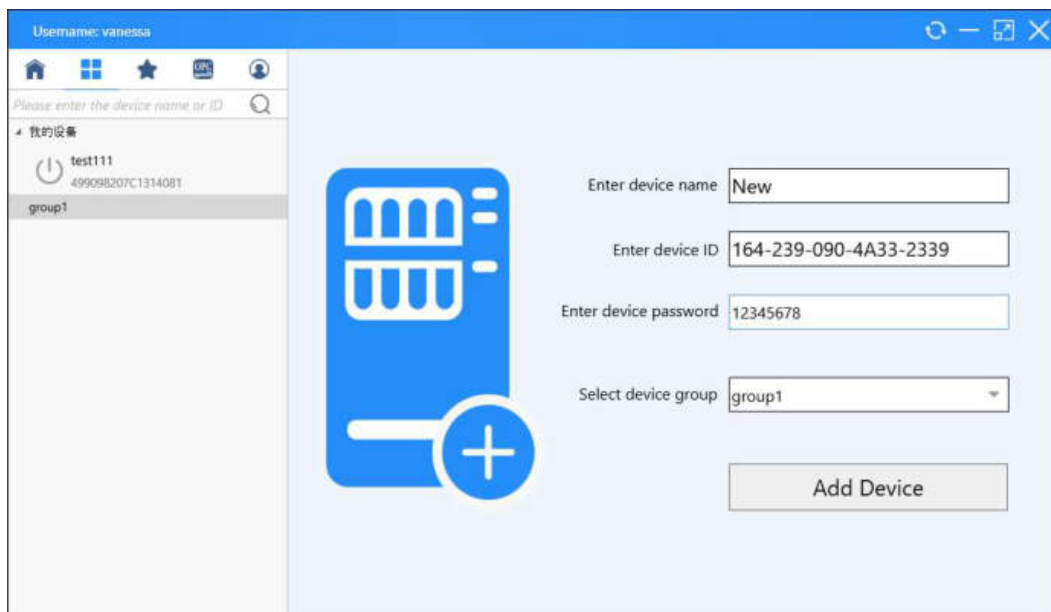

- (4) Remote checking it.

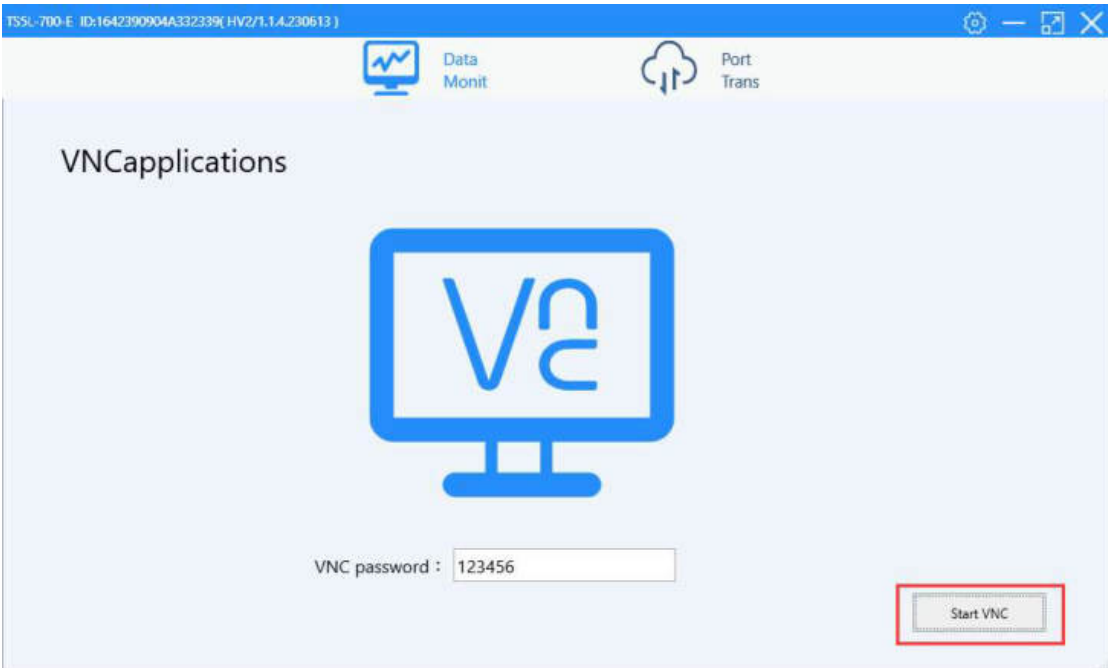
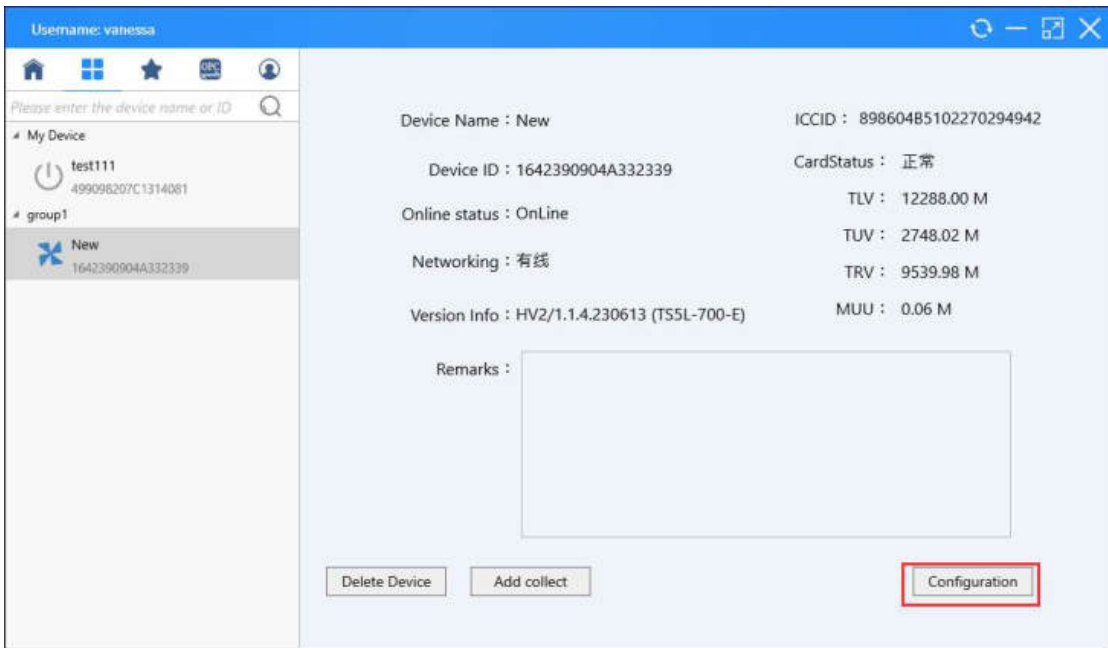

8-4-3. PC connection

The PC end mainly relies on the Xinje Cloud, which can achieve multi end access and be used directly in the browser.

Xinje Cloud Website: <https://cloud.xinje.net/>

Note: please refer to Xinje Cloud V4.1 user manual for details.

- (1) Xinje Cloud account register and login.



(2) Add item

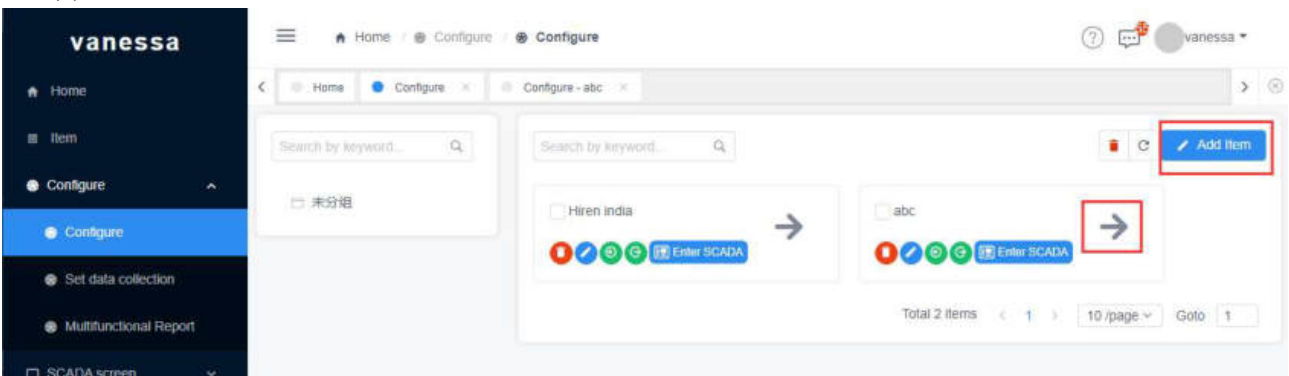

(3) Add device

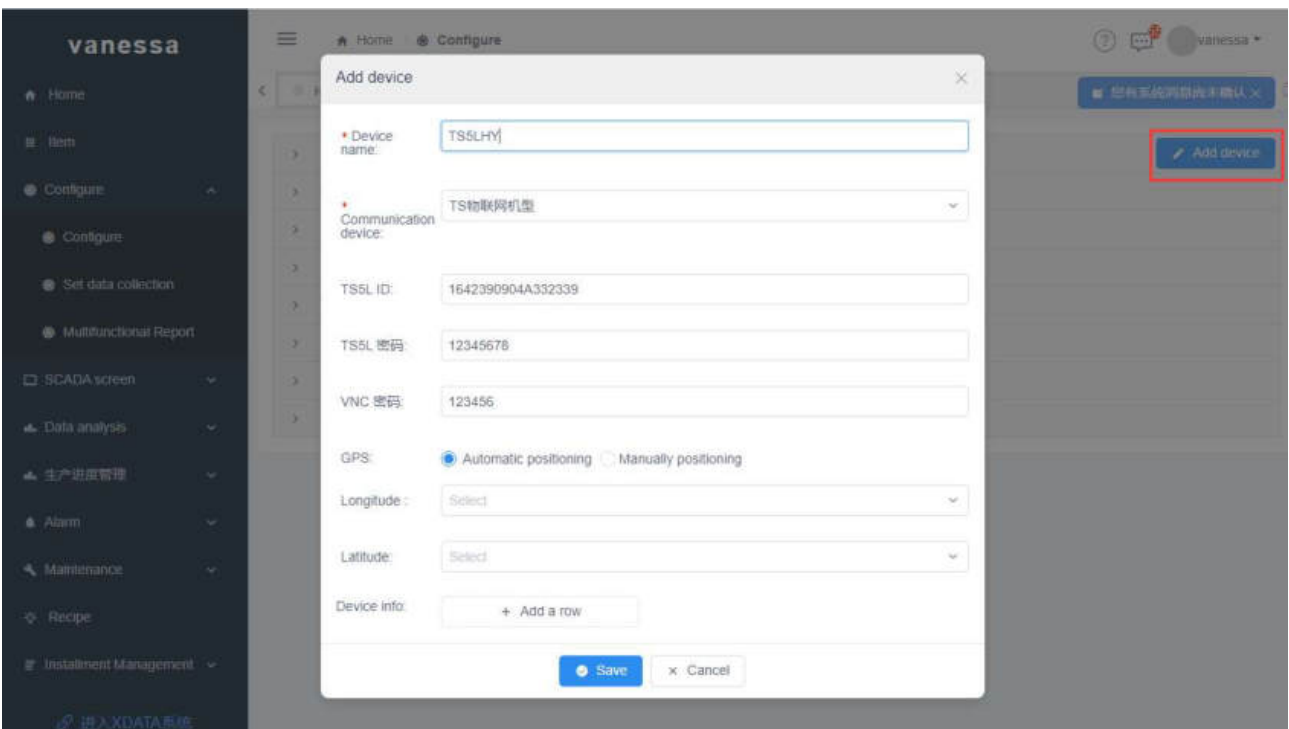

(4) Check the item

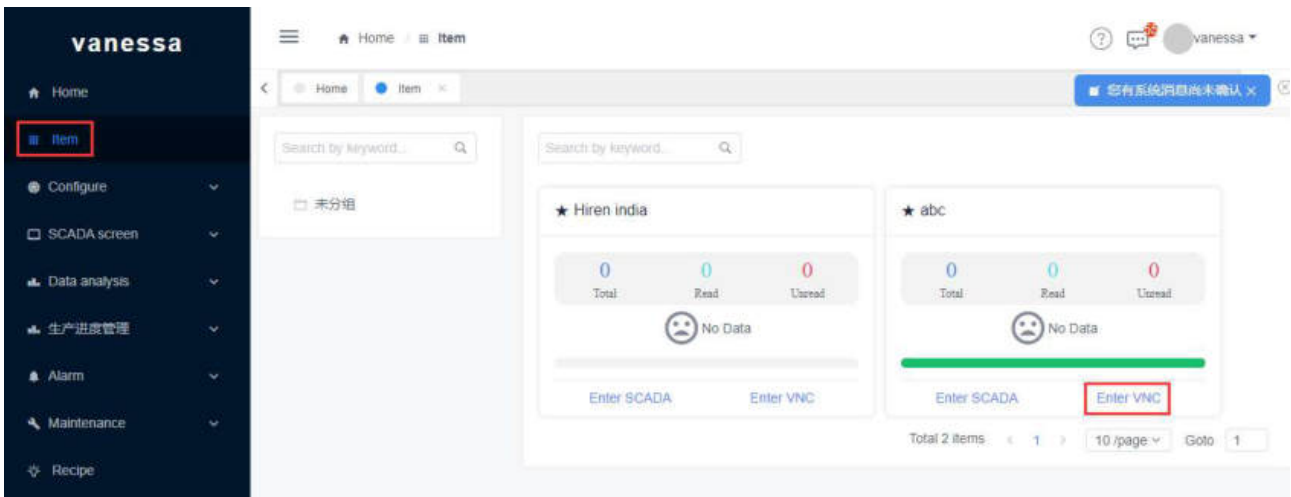

(5) Remote login to check, select image quality, compression level as the actual condition.



8-4-4. Mobile connection

The mobile end mainly relies on the Xinje Cloud to achieve multi end access, which can be directly used in apps and WeChat mini programs.

APP and Mini Program Address:



for IOS or Android



for Wechat app

- (1) Project binding on Xinje Cloud PC end, refer to 8-4-3 for details.
- (2) Remote connection (take wechat app as an example)

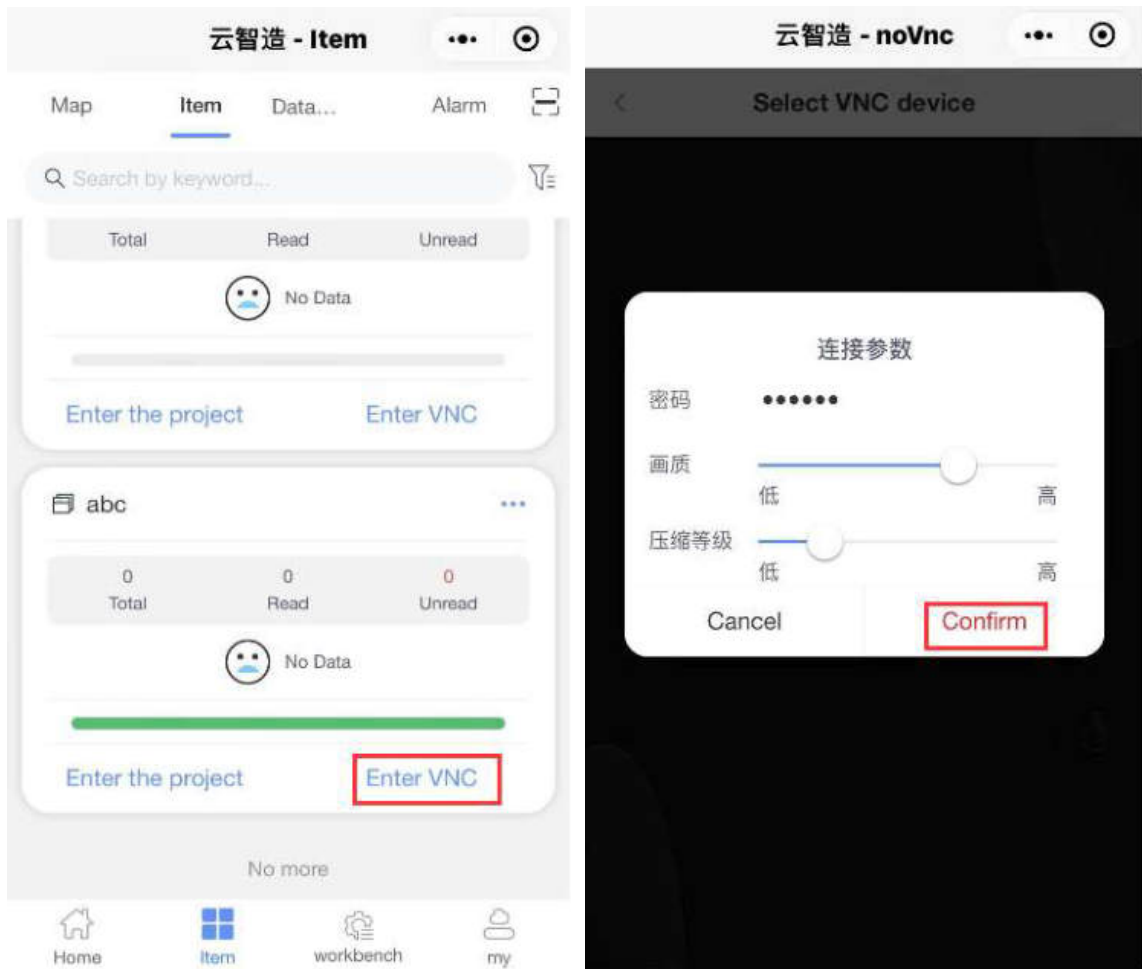

8-5. Online transmission

Transparent transmission function, which means that the computer does not need to be connected to a PLC, but only needs to be connected to a HMI to control the PLC. The PLC program can be directly downloaded and monitored through the HMI. Two transparent transmission methods are currently supported: serial port transparent transmission and VPN transparent transmission.

Transparent transmission function requirements: The HMI is TS5 series, and the PLC is connected to the HMI through serial/network ports.

If the TS5 access Internet mode is wired mode, only serial port transparent transmission is supported.

8-5-1. Serial port transparent transmission

The screenshot shows a software window titled 'Informatizati' with several tabs: 'Status information', 'Networking settings', 'Remote settings', 'Online transmission', and 'Data release'. The 'Online transmission' tab is active. At the top, there is a dropdown menu for 'Transmission mode' set to 'serial port passthru'. Below this, there are two columns of settings for 'COM1' and 'COM2'. Each column includes dropdown menus for 'Baud rate' (19200), 'Data bits' (8), 'Check digit' (Even), and 'Stop bit' (One). There are also dropdown menus for 'Virtual serial' (COM1 and COM2) and checkboxes for 'Enable status' (Enable COM1 and Enable COM2). At the bottom of each column are buttons for 'Reset virtual serial' and 'Enable virtual'. At the very bottom of the window are buttons for 'Applicatio', 'Ok', and 'Cancel'.

transmission mode	Serial port transparent transmission, VPN transparent transmission
baud rate	9600/19200/38400/57600/115200
data bit	7/8
parity bit	None/Odd/Even
stop bit	None/One/Two/OnePointFive
virtual serial port	COM1-COM255 optional
enable status	Check whether to enable COM1/COM2 ports, both serial ports can be enabled for virtual serial

	ports at the same time
reset virtual serial port	After modifying multiple serial port parameters, it can be directly reset
enable virtual	Enable the virtual serial port of COM1/COM2 for further transparent operation

Serial port transparent connection steps:

- (1) Connect the COM port of the PLC to the COM port of the TS5 through an XVP cable.
- (2) Connect the HMI to the PC using a local area network/remote connection (refer to chapter 8-1), and enter the Information Settings - Online Transparent Transmission interface.
- (3) Set the serial port transmission related parameters, including baud rate, data bits, check bits, stop bits, etc., to be consistent with the PLC serial port parameters. Select the virtual serial port and enable it to start the transparent transmission service.

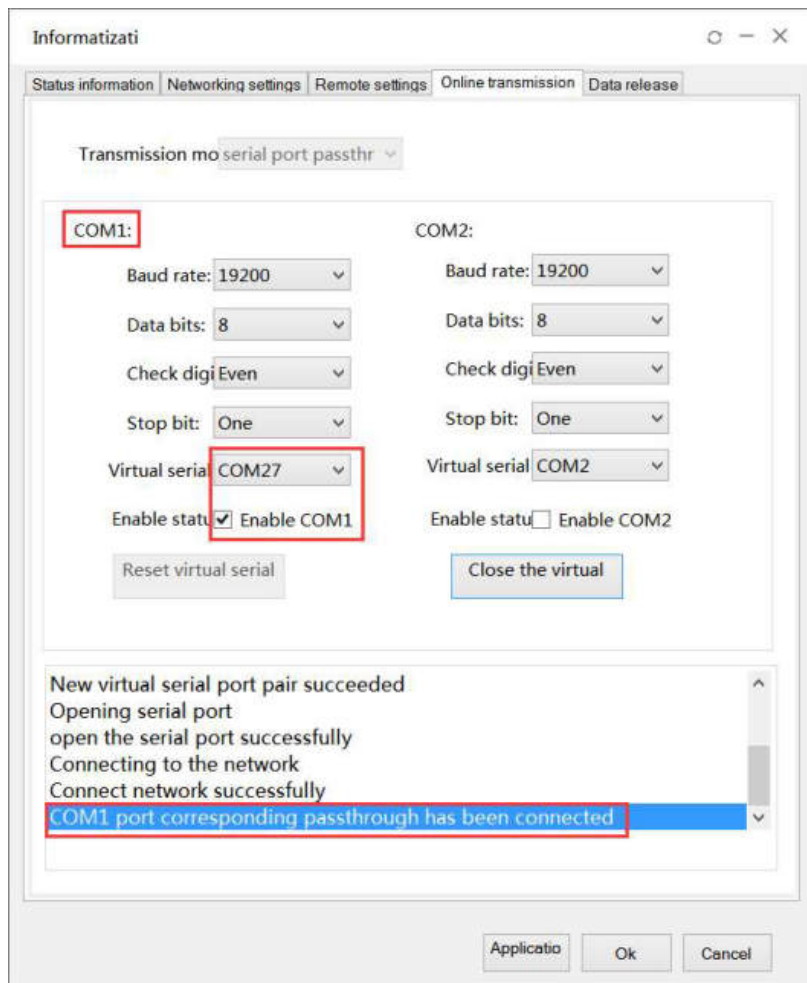

After enabling, the Device Manager interface will have a virtual serial port as shown in the figure below. Click "Abort" or "Clear residual virtual serial port", and the established virtual serial port will exit and no longer occupy the system port number.



- (4) Open PLC programming software XDPpro.

① select local serial port (COM1), click Comm-test, it shows “connect to PLC succeeded”, click ok.

② after connecting, the right lower corner will show **1,Scan Cycle:0.0m:**, now user can download and monitor the PLC program.

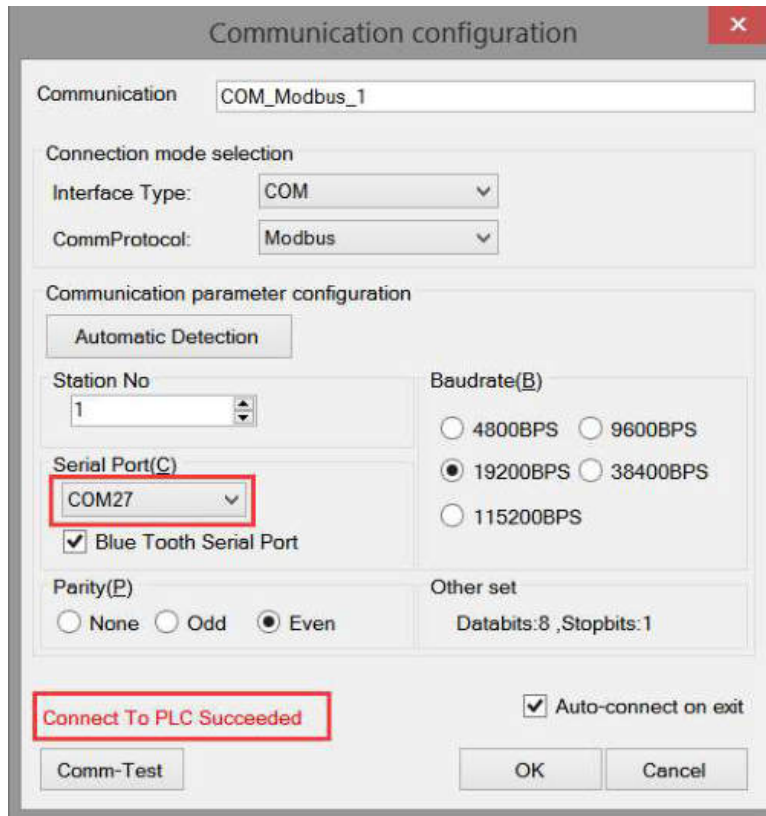

Note:

1. During transparent transmission, it is necessary to maintain network connectivity. If disconnected, it will affect transparent transmission operations.
2. Transparent transmission can only be operated on the premise that PLC and HMI can communicate normally. During transparent transmission, communication between HMI and PLC will be disconnected, and it will resume after the transparent transmission is completed.
3. Only serial port transparent transmission is supported in LAN connection, and two transparent transmission methods are supported in remote connection mode.
4. Try to avoid using COM1 and COM2 for virtual serial ports to avoid confusion.

8-5-2. VPN transparent transmission

VPN transparent transmission steps:

- (1) PLC and HMI are connected through a network cable.
- (2) Configure HMI to remote connection mode and enter the information settings online transparent transmission interface

(3) Select VPN transparent transmission method, set the network segments of PLC, HMI, and virtual gateway in the same network segment, and click "Enable VPN".



(4) Open PLC programming software XDPpro.

① enter the device IP and local IP, local IP refers to the local IP of the virtual network card, click Comm-test, it shows “connect to PLC succeeded”, click ok.

② after connecting, the right lower corner will show 1,Scan Cycle:0.00ms, now user can download and monitor the PLC program.

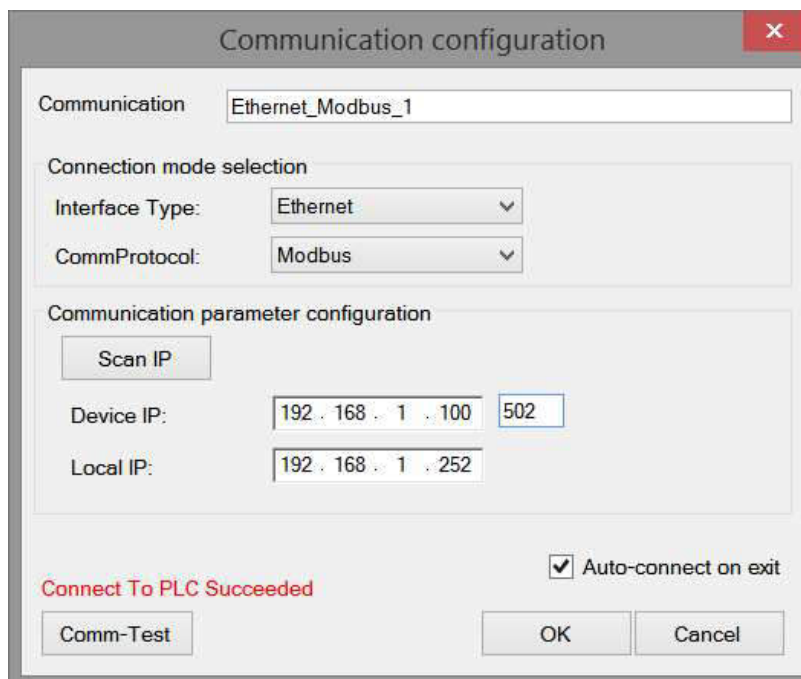

Note:

- (1) Please refer to ABOX user manual for other brands of PLC transparent transmission method.
- (2) Siemens S7-200 smart, Matsushita FP-XH series PLC cannot support serial port transparent transmission.
- (3) Enabling VPN will occupy the HMI IP, and the IP in the bottom right corner of the touch screen will be blank. After turn off the VPN, will default to the previous IP address.
- (4) Transparent transmission supports the use of TouchwinPro software and Boxmanger software in the same way.

8-6. Data release

8-6-1. Data release configuration

Data release refers to sending local data information to the cloud through a specified protocol. Data release function requirements: The HMI is TS5 series, 4G/WIFI/wired connected and can access the corresponding server.

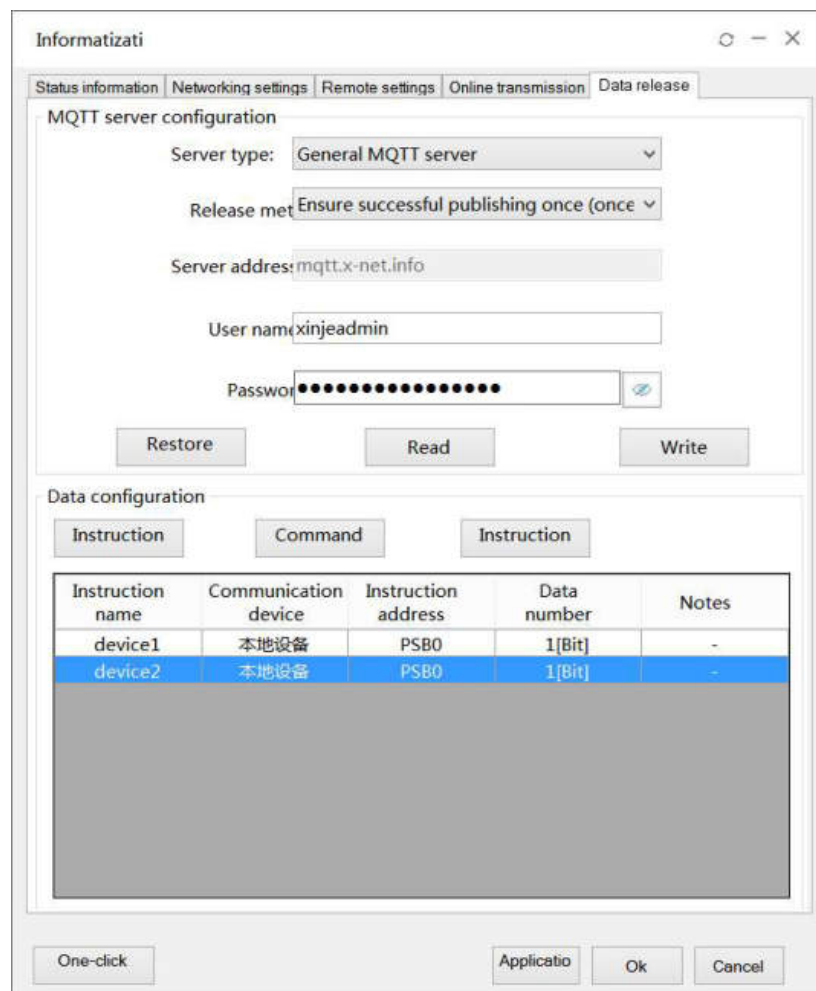

MQTT server setting

server type		general MQTT server /Aliyun server/Custom server
release method	publish once	Corresponding QoS service quality level: QoS0, published only once, regardless of whether it reaches the publisher or not, the publisher (when the client or server is the sender) only sends once, regardless of whether the receiving end has received

	the data
Successfully published at least once (possibly multiple times)	Corresponding QoS service quality level: QoS1, successfully published at least once. The publisher needs to confirm upon arrival. After publishing the message, the publisher waits for the recipient's confirmation message. If the receiving end does not reply, resend it
Ensure successful publishing once (with and only once)	Corresponding QoS service quality level: QoS2, to ensure successful publication once, the publisher needs to confirm upon arrival, and the recipient needs to confirm again by the publisher
server address	Default mqtt.x-net.info and cannot be modified
user name	The default is xinjeadmin, which can be modified by users themselves
password	Default 16 bits password and not visible
restore	Restore the publishing method, username, and password to the default configuration
read	Read the published MQTT configuration, password, username, and publishing method
write	Write the latest configuration to the MQTT server

Data Configuration: Configure data publishing, allowing for creation, deletion, and editing of published content.

add instruction	Add instructions to be released
edit instruction	Edit the added instructions to view their details or modify them
delete instruction	To delete an added instruction, left click on the line that needs to be deleted and click on the instruction to delete it

Click on the command add to enter the data command configuration and edit the data source

device command:

command name	Name the current instruction, the instruction name cannot be empty
--------------	--

communication device	Select the data source, which can be connected to devices within the HMI project or local HMI
data specification	select the data format, Bit/Word
add method	Single addition: mapping one instruction to one address Batch Add: Multiple addresses mapped to a specified command (with consistent data types)
data object	select the register type
start address	enter the start address

MQTT:

data type	the data type includes INT16U, INT16S, INT32U, INT32S, INT64S, Float, Double, Char[]
trigger method	Triggered when the value changes, triggered when the condition is met, and triggered at a fixed time
trigger condition	Trigger conditions are divided into: less than, within range, greater than, not equal to, and beyond range
minimum	Set the minimum value of the range. When the trigger condition is greater than, this item is not filled in
maximum	Set the maximum value of the range, and leave this field blank when the trigger condition is less than
publish space	The interval between publishing data, in seconds
remark	Comment name for data

Click on the command edit and enter the editing interface:

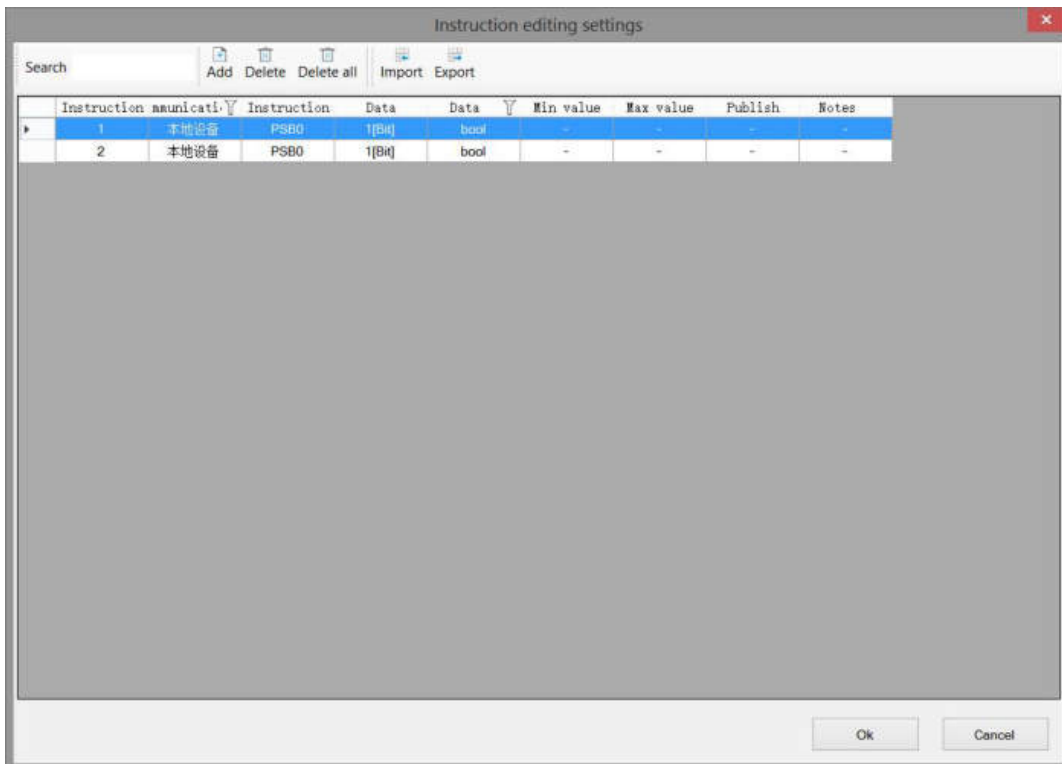

search	Enter relevant keywords to search
add	add a instruction
delete	Select a line of instructions to delete
delete all	delete all the commands

8-6-2. Xinje cloud server

Operation steps (take Xinje Cloud server as an example):

- (1) Enter the information settings - data release interface.

The screenshot shows a software window titled "Informatizati" with several tabs: "Status information", "Networking settings", "Remote settings", "Online transmission", and "Data release". The "Data release" tab is active and highlighted with a red box. Underneath, there are two main sections: "MQTT server configuration" and "Data configuration".

The "MQTT server configuration" section contains the following fields:

- Server type: General MQTT server (dropdown menu)
- Release method: Ensure successful publishing once (once) (dropdown menu)
- Server address: mqtt.x-net.info (text input)
- User name: xinjeadmin (text input)
- Password: [masked with dots] (password input)

Below these fields are three buttons: "Restore", "Read", and "Write".

The "Data configuration" section has three tabs: "Instruction", "Command", and "Instruction". The "Instruction" tab is selected. Below the tabs is a table with the following columns: "Instruction name", "Communication device", "Instruction address", "Data number", and "Notes". The table body is currently empty.

At the bottom of the window are four buttons: "One-click", "Applicatio", "Ok", and "Cancel".

- (2) select server type: general MQTT server.

This is a close-up view of the "MQTT server configuration" section from the previous screenshot. The "Server type" dropdown menu is highlighted with a red box, and the text "General MQTT server" is visible within the dropdown. The other fields in this section are also visible: "Release method" (Ensure successful publishing once (once)), "Server address" (mqtt.x-net.info), "User name" (xinjeadmin), and "Password" ([masked]). The "Restore", "Read", and "Write" buttons are also present at the bottom.

- (3) select release method, please choose it as needs.

MQTT server configuration

Server type: General MQTT server

Release method: Ensure successful publishing once (once)

Server address: Ensure successful publishing once (once)

User name: xinjeadmin

Password: [masked]

Restore Read Write

(4) click add instruction, click ok after addition.

Data configuration

Instruction Command Instruction

Data instruction configuration

Device command

Command: [text box] Communicate: 本地设备

Data specification: Bit Add method: Single addition

Data object: PSB Start address: 0 . 0

MQTT

Data type: BOOL(Bool) Trigger method: Triggered when the value

Trigger condition: less than Minimum: [text box]

Maximum: [text box] Publish every: [text box] S

remark: [text box]



Note: When adding or deleting device protocols in the system settings, it is necessary to download the project to the HMI in order to update the communication devices in the data command settings.

- (5) After adding instructions, click Apply or Confirm, then power on the HMI again to complete data publishing. After successful publishing, open the Xinje Cloud Server and proceed to the next step on the server.

Informatizati

Status information | Networking settings | Remote settings | Online transmission | Data release

MQTT server configuration

Server type: General MQTT server

Release method: Ensure successful publishing once (once)

Server address: mqtt.x-net.info

User name: xinjeadmin

Password: [masked]

Restore Read Write

Data configuration

Instruction Command Instruction

Instruction name	Communication device	Instruction address	Data number	Notes
D20	本地设备	PSW20	1[Word]	-

One-click Applicatio Ok Cancel



- (1) Xinje Cloud Server Monitoring currently does not support monitoring bit group addresses.
- (2) The cloud platform corresponding to the Xinje MQTT protocol is limited to Cloud V4.1 and above.
- (3) For specific details on the operation of the cloud platform, please refer to the cloud platform manual "Xinje Cloud V4.1 User Manual".

Xinje Cloud operation steps:

- (1) login Xinje Cloud, add a new project.

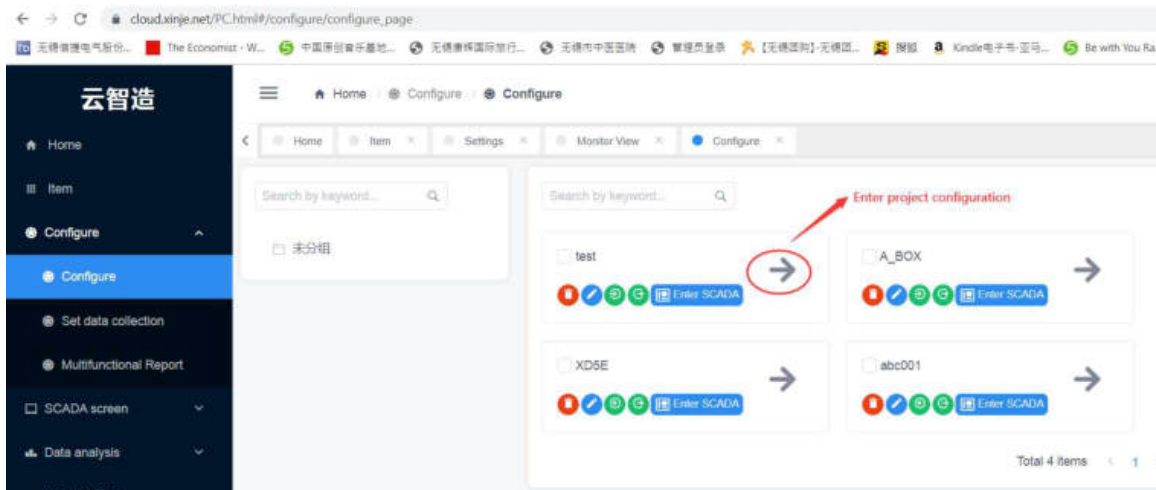

- (2) After entering the project, click "New Device", select the TS IoT model for the communication device, and then enter the ID number of the HMI and the TS5L password (remote password, 12345678 by default), which can be modified on the screen. The cloud platform limits 8 bits password, VNC password (123456 by default), and click Save.

Add device [Close]

* Device name:

* Communication device:

TS5L ID:

TS5L 密码:

VNC 密码:

- (3) Monitor in [device configuration]: click “refresh device” and monitor to see all the data.

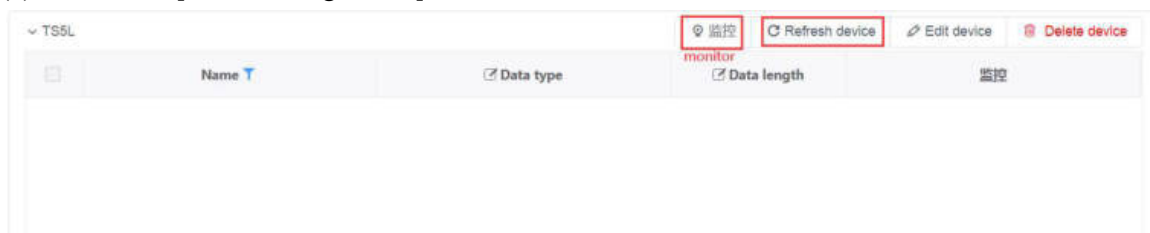

- (4) Monitor in [data source]: after adding device, click “batch import”, it will pop up a window. Select the device added just now, then select “import all” or “import part”. After importing, click monitor to monitor the data.

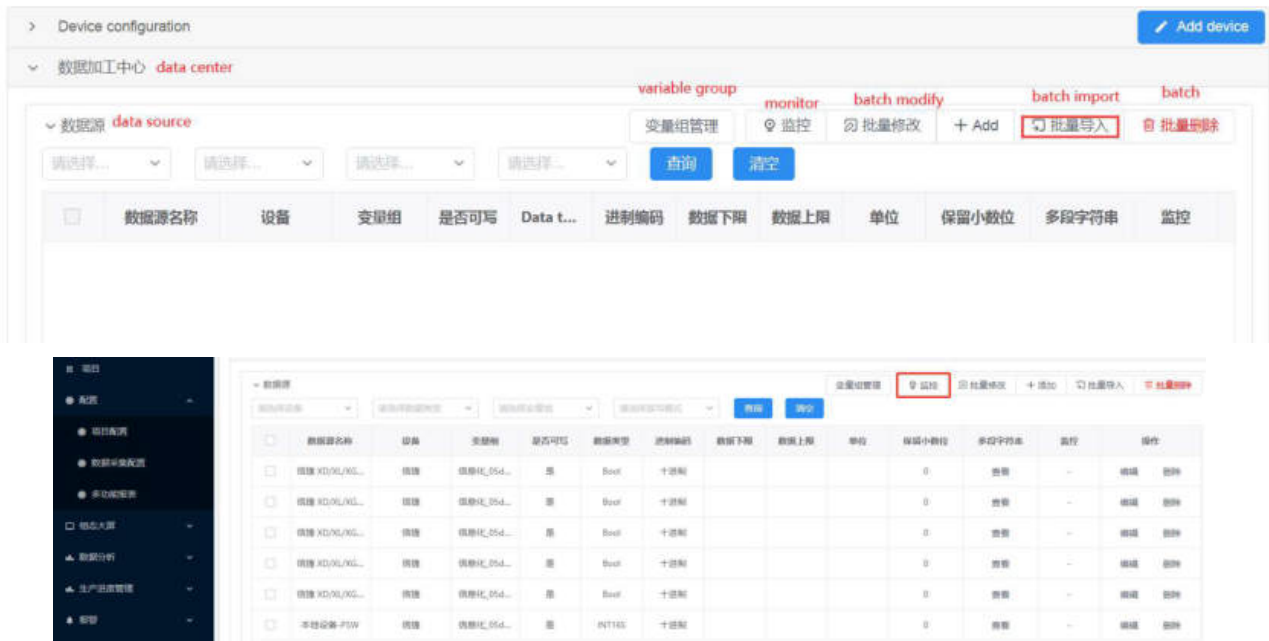

(5) Xinje Cloud VNC monitor: select the project, click “enter VNC”. Select the device name, click connect, input correct VNC password (default is 123456) to enter VNC interface

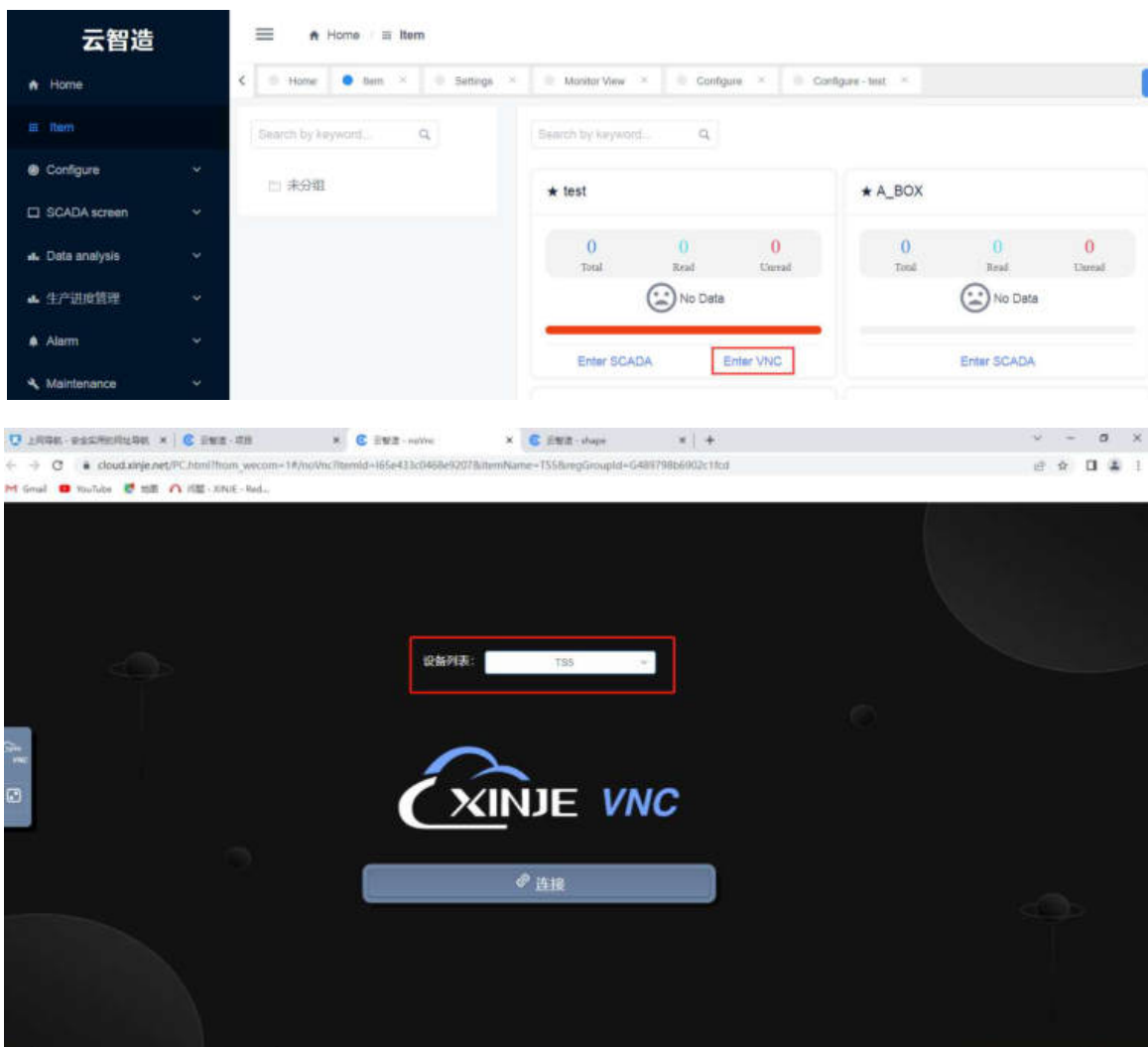



Note: Please refer to the Xinje Cloud manual for the specific operation of the cloud platform.

8-6-3. Custom MQTT server

Operation steps:

- (1) Enter information interface, click Data release, select custom MQTT server. Then set the server name and user name, password.

The screenshot shows the 'Informatizat' application window with the 'Data release' tab selected. The 'MQTT server configuration' section includes the following fields:

- Server type: Custom MQTT server (highlighted with a red box)
- Server name: [Empty text box]
- Release mode: Ensure successful publishing once (o (highlighted with a blue box)
- Server address: [Empty text box]
- User name: [Empty text box]
- Password: [Empty password box with eye icon]

Buttons for 'Restore', 'Read', and 'Write' are located below the configuration fields. The 'Data configuration' section below has tabs for 'Instruction', 'Command', and 'Instruction'. A table with the following headers is visible:

Instruction name	Communication device	Instruction address	Data number	Notes
[Empty table body]				

At the bottom of the window are buttons for 'One-click', 'Applicati', 'Ok', and 'Cancel'.

- (2) Select the release mode as you need.

This close-up shows the 'Release mode' dropdown menu expanded. The options are:

- Ensure successful publishing once (o (highlighted with a blue box)
- Publish only once
- Publish successfully at least once (possib
- Ensure successful publishing once (once

The other configuration fields and buttons from the previous screenshot are partially visible in the background.

(3) Click Instruction, add the instruction to be monitored, click ok after adding.

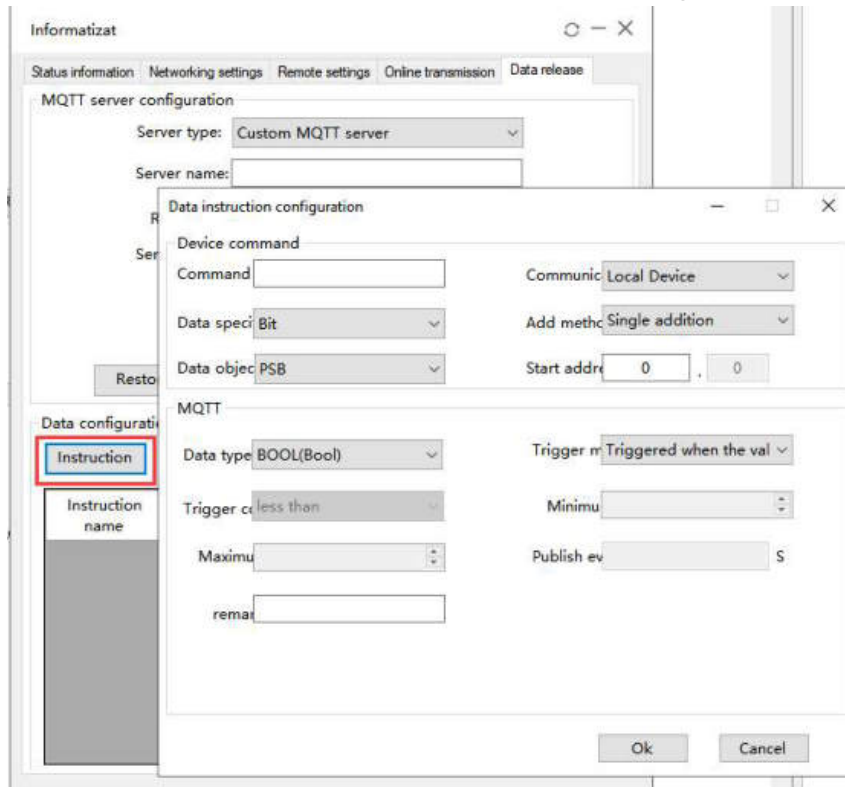

When adding or deleting device protocols in the system settings, it is necessary to download the project to the HMI in order to update the communication devices in the data command settings.

(4) After adding instructions, click on the application or ok button and power on the HMI again to complete the data publishing. After successful publishing, open the Cloud server and proceed to the next step.



Currently, port number settings are not supported;

The specific cloud server needs to be deployed independently and can be debugged using MQTT.fx;

The message format can refer to 8-6-5 MQTT Data Explanation.

8-6-4. Aliyun server

Operation steps:

(1) Log in the Aliyun website (<https://www.aliyun.com/>). Log in to your account and open the IoT platform.



(2) Select manage the console;



(3) Click Public instance.



- (4) Create a product in the "Product" column of "Device Management", set relevant configurations, and confirm saving.

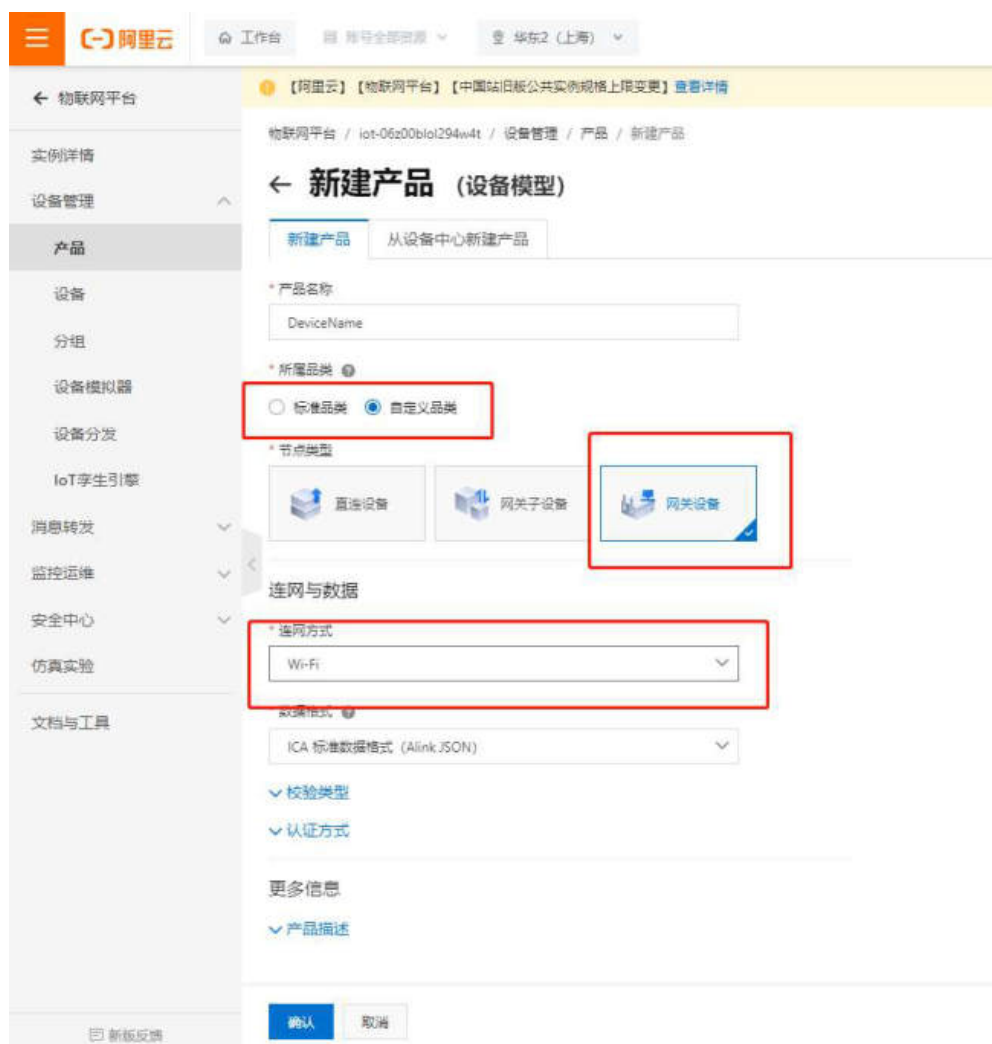

- (5) In "Devices", click "Add Device", set a "DeviceName" for the device, and set relevant configurations;

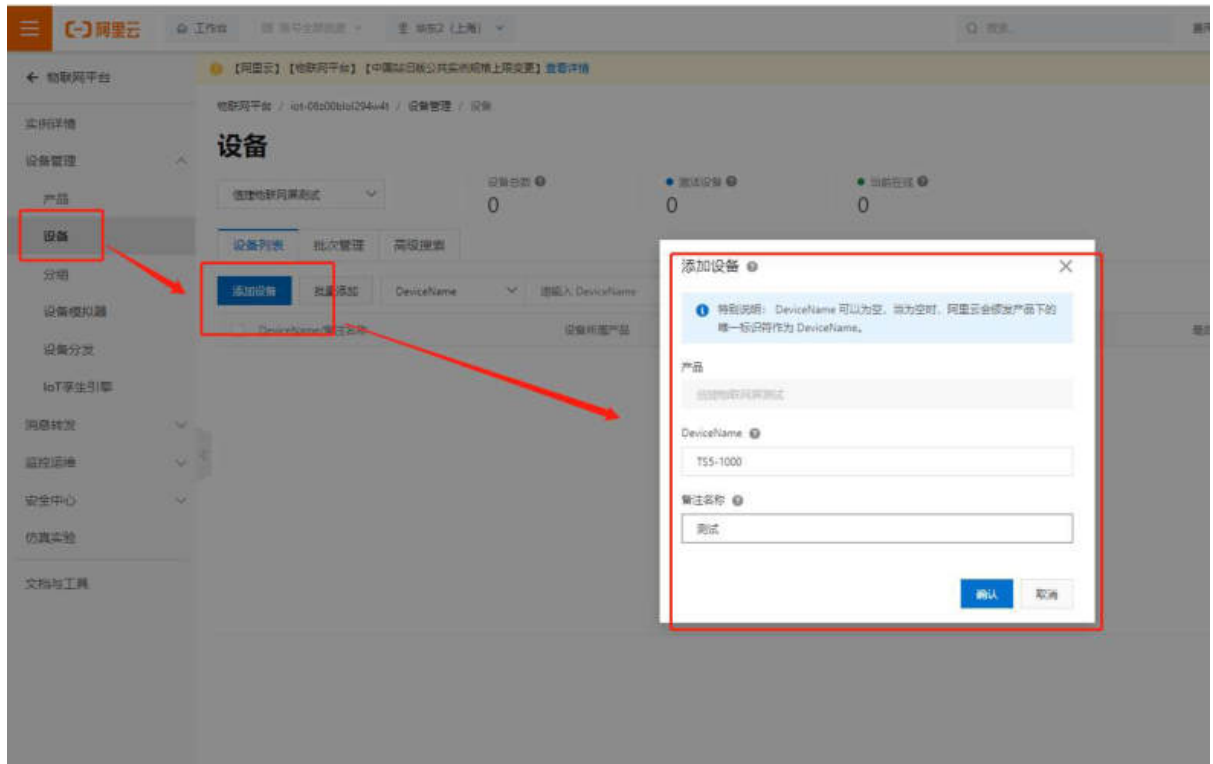

- (6) Click View - After entering the device, click "DeviceSecret" to view. Copy the device certificate with just one click. View "Region" as "East China 2 (Shanghai)".

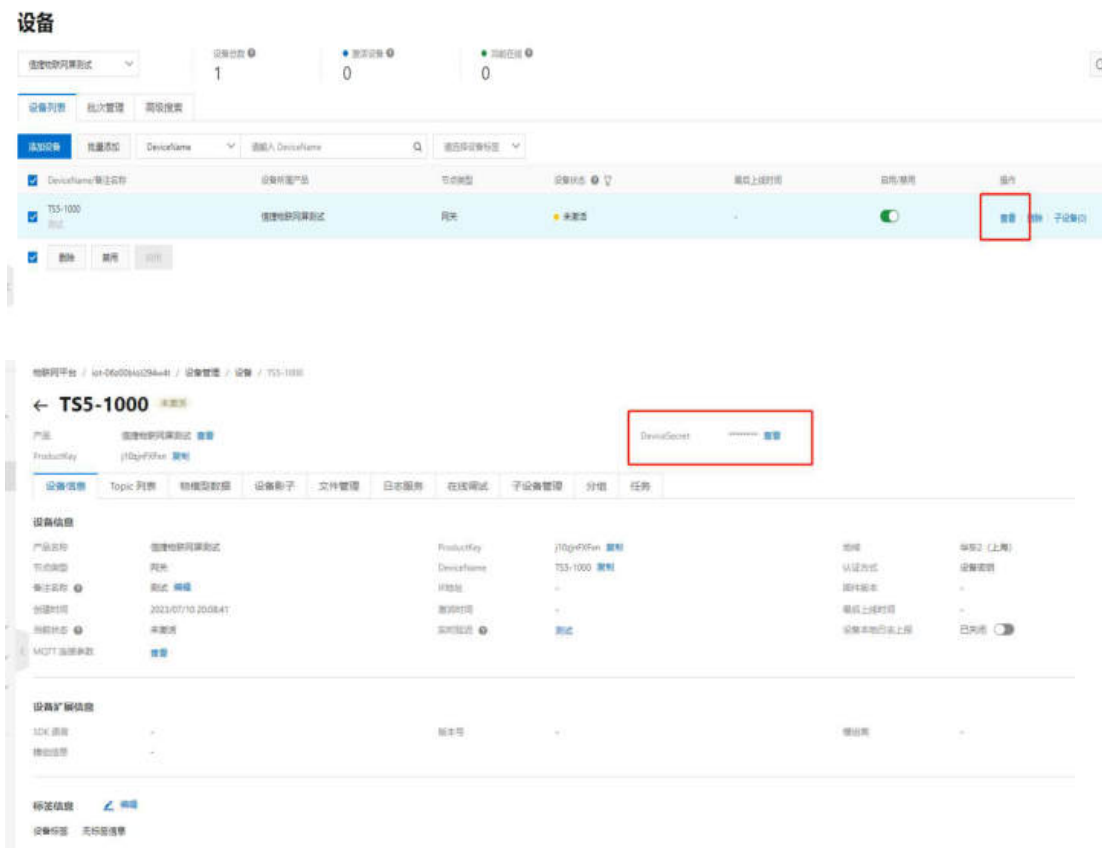

- (7) Connect to the IoT HMI, select "Aliyun Server Settings" in "Server Type", paste the one-click copied device certificate into the input box, and select "East China 2" for region information.



- (8) In the Aliyun IoT platform, select the created product in the product category, click "Function Definition", and then click "Edit Draft".

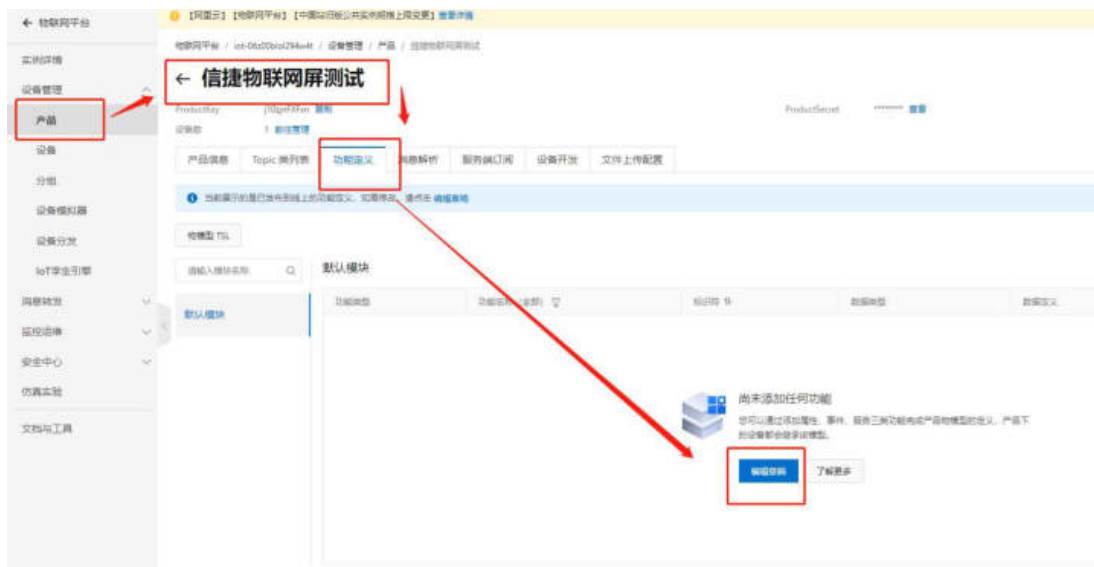

- (9) Click "Add Custom Function" to define data names, types, units, etc. After adding the data, click "Publish Online". The current upper computer version only supports attributes, and the service and event functions have not been developed yet.

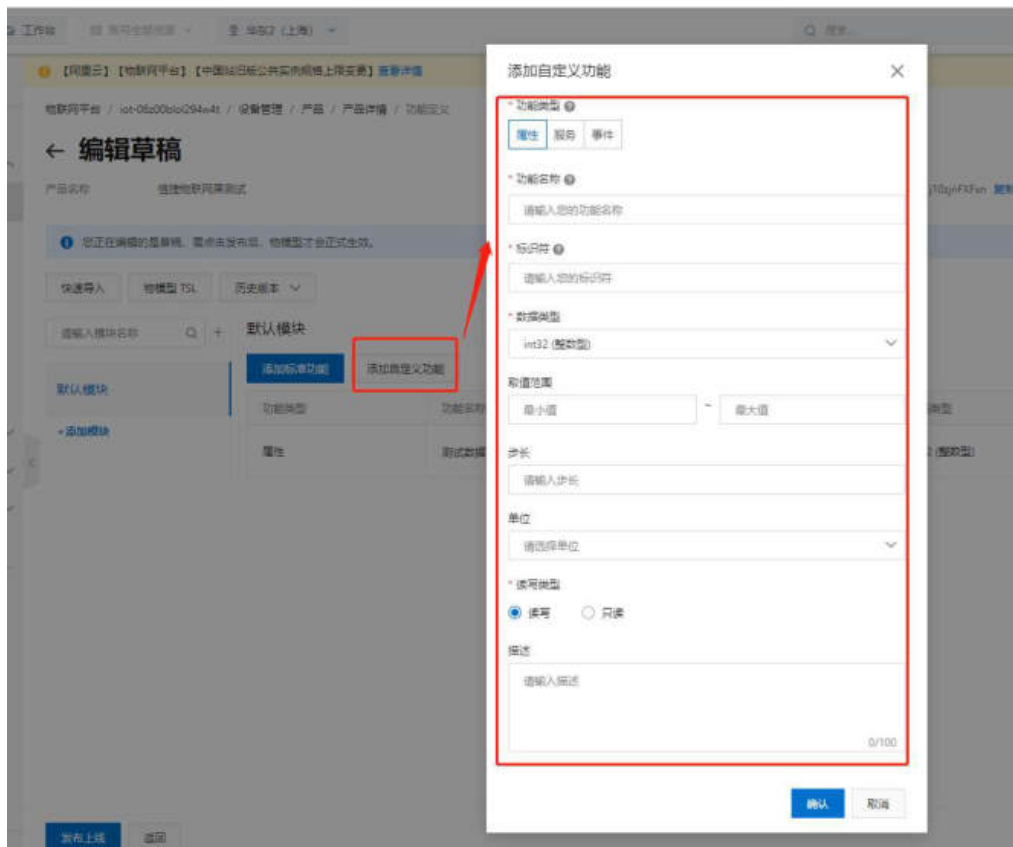

(10) Click on "Model TSL" and in the Perfect Model, select "Ctrl+A" and then "Ctrl+C" to copy or export the model file.

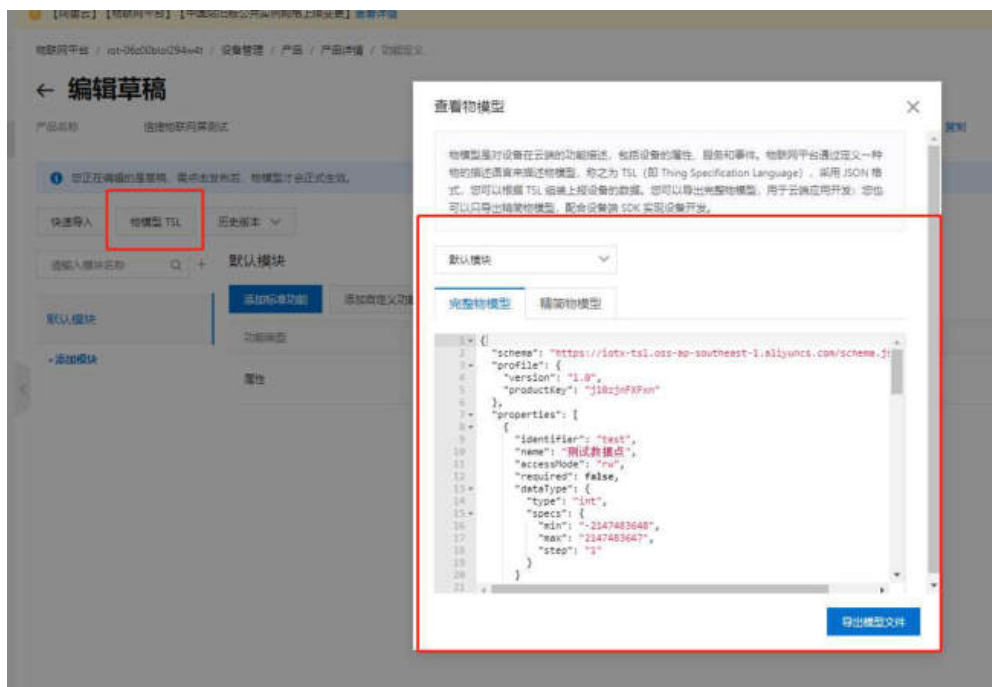

(11) In data publishing, select the imported object model and paste it in the "Perfect Object Model JSON Text" using Ctrl+V. After pasting, click on "Import Object Model Text". Or directly import the object model Josn file.



(12) Select the command to add. At this point, the relevant data points can be selected. Once the settings are complete, click on Apply, download the program, or restart to complete the relevant settings.

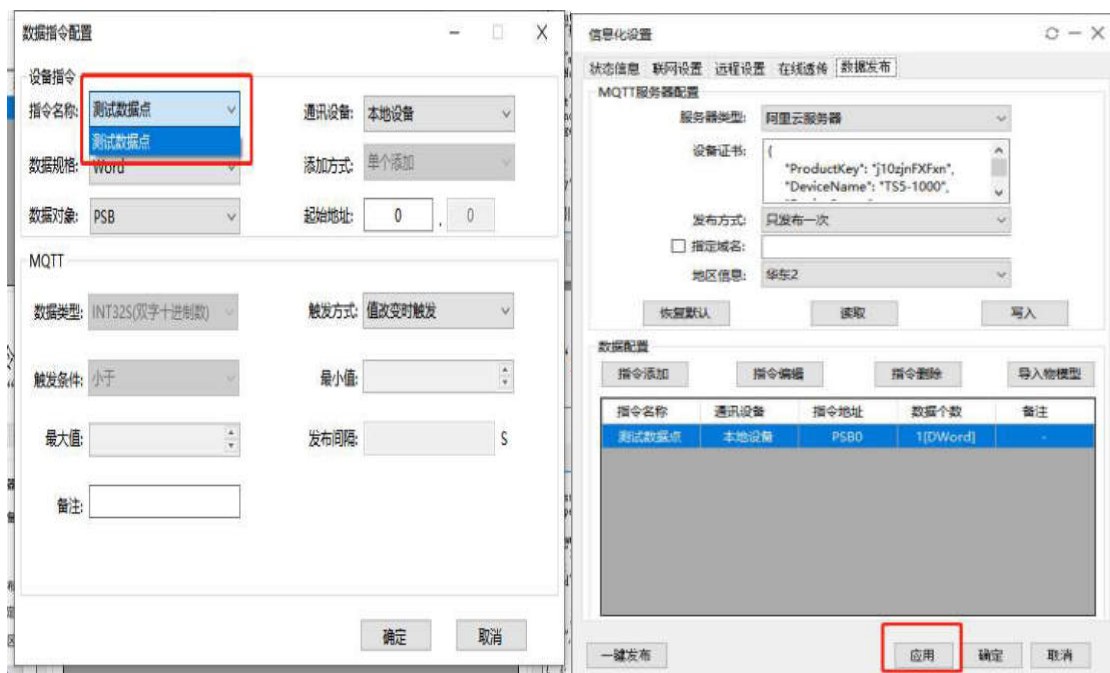

8-6-5. MQTT Data Explanation

*Chinese characters in Json format: UTF-8

■ Client ID name: IDPWDUserdata

■ TOPIC

Function name	Type	Topic	Explanation
Report Configuration List	release	ID+PWD/pub_configlist	Retain type, click on the application to publish once
Data reporting	release	ID+PWD/pub_data	The device actively reports real-time data
Data control request	subscribe	ID+PWD/write_data	Platform side initiates data point control request
Data control reply	release	ID+PWD/write_reply	Device side reply data control result
Proactively obtaining data	subscribe	ID+PWD/access_data	Obtain data

■ Report configuration list

Title	ID+PWD/pub_configlist
Release conditions	The client clicks "Apply" once to publish it; Retain type. Add system data tables by default.
payload instance	<pre>{ "Unix": "1614576888000", "Version": "V1.0", "Configlist": { "Device 1": [{ "Order_name": "temperature", "Order_ID": "43912342299231234+0", "Order_type": "INT8S" }, { "Order_name": "length", "Order_ID": "43912342299231234+1", "Order_type": "Float" }, { "Order_name": "yield[6]", "Order_ID": "43912342299231234+2", "Order_type": "Float" }], "Device 2": [{ "Order_name": "temperature", "Order_ID": "43912342299231234+3", "Order_type": "INT8U" }, { "Order_name": "length", "Order_ID": "43912342299231234+4", "Order_type": "Float" }] }</pre>

		<pre> }, { "Order_name": "yield[6]", "Order_ID": "43912342299231234+5", "Order_type": "Float" }], "Localghost": [{ //system information list "Order_name": "GPS latitude ", "Order_ID": "43912342299231234+6", "Order_type": "Float" }], { "Order_name": "GPS longitude ", "Order_ID": "43912342299231234+7", "Order_type": "Float" }], { "Order_name": " System runtime [4]", "Order_ID": "43912342299231234+8", "Order_type": "INT8S" }] } </pre>
--	--	--

parameter	Unix	The time of publication, formatted as a millisecond level UNIX timestamp (in milliseconds since 1970).
	Version	Protocol version number, the current protocol version is fixed to "V1.0".
	Configlist	Root node of device list.
	Device 1, device 2	The name of the added device in data publishing.
	Order_name	The instruction name, if followed by "[6]", indicates that the instruction is batch added, and the length is the number of batch additions.
	Order_ID	Instruction ID, unique, is a unique identifier used to bind data to the cloud platform.
	Order_type	Data type (Pay attention to distinguishing between uppercase and lowercase letters) Bool/INT8U/INT8S/INT16U/INT16S/INT32U/INT32S/INT64S/Float/Double/Char[]

■ Data reporting

Title	ID+PWD/pub_data
Report real-time data	<pre> { "Variant": [{ "Unix": "1614576888000", "Version": "V1.0", "Pub_Data": { "Device 1": { "temperature": 23, "humidity": 50.23, "yield[6]": [12, 32, 43, 53, 15, 53] } } }] </pre>

		<pre> } }]] } </pre>
parameter	Variant	Root node, array format.
	Unix	The time of publication, formatted as a millisecond level UNIX timestamp (milliseconds since 1970)
	Version	Protocol version number, the current protocol version is fixed to "V1.0".
	Pub_data	Data root node.
	device 1, device 2	The name of the added device in data publishing.
	Instruction key value pairs	If the instruction name is followed by "[6]", it indicates that the instruction is batch added, and the value of the data is the actual value of the batch added data.
Report message cache data		<pre> { "Variant": [{ "Unix": "1614576888000", "Version": "V1.0", "Pub_Data": { "device 1": { { "temperature": 23, "length": 50, "yield[6]": [12, 32, 43, 53, 15, 53] } "device 2": { "temperature": 23, "length": 50, "yield[6]": [12, 32, 43, 53, 15, 53] } } } } { "Unix": "1614576400000", "Version": "V1.0", "Pub_Data": { "device 1": { "temperature": 44, "length": 50, "yield[6]": [12, 32, 43, 33, 15, 53] }, "device 2": { "temperature": 13, "length": 60, "yield[6]": [12, 32, 123, 53, 15, 53] } } } </pre>

	<pre> } } }] }</pre>
--	---

■ Data control request

Title		ID+PWD/write_data
payload instance	Write single or multiple pieces of data	<pre> { "Unix": "1614576888000", "Version": "V1.0", "Write_Data": { "device 1": { "temperature": 20, "length": 16, "yield[2]": 55, "yield[4]": 22 }, "device 2": { "temperature": 20, "length": 16, "yield[2]": 55, "yield[4]": 22 } } }</pre>
Parameter	Unix	The time of publication, formatted as a millisecond level UNIX timestamp (milliseconds since 1970)
	Version	Protocol version number, the current protocol version is fixed to "V1.0".
	Write_data	Root node.
	device1,device2	The name of the added device in data publishing.
	Instruction key value pairs	If the instruction name is followed by "[]", it indicates that the instruction is batch added, and "[2]" is offset, referring to the third production data

■ Data control request reply

Title		ID+PWD/write_reply
Payload instance		<pre> { "Unix": "1614576888000", "Version": "V1.0", "Write_Reply": { "device 1": {</pre>

		<pre> "temperature": "OK", "length": "OK", "yield[2]": "OK", "yield[4]": "OK" }, "device 2": { "temperature": "ERROR0", "length": "ERROR1", "yield[2]": "ERROR2", "yield[4]": "ERROR0" } } </pre>
Parameter	Unix	The time of publication, formatted as a millisecond level UNIX timestamp (milliseconds since 1970)
	Version	Protocol version number, the current protocol version is fixed to "V1.0".
	Write_data	Root node.
	device1,device2	The name of the added device in data publishing.
	Instruction key value pairs	<p>If the instruction name is followed by "[]", it indicates that the instruction is batch added, and "[2]" is offset, referring to the third production data</p> <p>Execution result: OK: Execution succeeded</p> <p>ERROR0: Write value failed</p> <p>ERROR1: The instruction was not found</p> <p>ERROR2: Other errors</p>

■ Obtained data

	Title	ID+PWD/access_data
	Payload instance	<pre> { "Unix": "1614576888000", "Version": "V1.0", "Content": "savedata" } </pre>
Parameter	Unix	The time of publication, formatted as a millisecond level UNIX timestamp (milliseconds since 1970)
	Version	Protocol version number, the current protocol version is fixed to "V1.0".
	Content	<p>"savedata": data of saving traffic mode</p> <p>"alldata": all the data</p> <p>"systemdata": system data</p>

Note: After subscribing to messages on the TS series IoT HMI, the returned data is published through "ID+PWD/pub_data".



XINJE

WUXI XINJE ELECTRIC CO., LTD.

Address: 816 Jianshe West Road, Binhu District, Wuxi City, Jiangsu Province, China

Tel: 0510-85134136

Fax: 0510-85111290

Website: www.xinje.com

Email: fiona.xinje@vip.163.com, sales@xinje.com