

NewPre5100

Autonomous and Controllable Edge General-Purpose Controller Hardware Installation Manual

Publication date: June 2022

Version: V1.1

No. : 112028573

Publication unit: Kyland Technology Co., Ltd.

Address: Floor 9, Building 2, Yard 30, Xishanhui, Shijingshan

District, Beijing

Website:<http://www.kyland.com.cn>

<http://www.kyland.cn>

Customer service hotline: 010-88796676

Fax: 010-88796678

Email: services@kyland.com.cn

KYLAND

Preface

This manual provides you with hardware installation instructions for the NewPre5100 Autonomous and Controllable Edge General-Purpose Controller.

Legal Statement

Kyland Technology Co., Ltd.. reminds you to carefully read and fully understand the terms of this Legal Statement before reading or using this document.

If you read or use this document, your reading or use will be deemed to be an endorsement of the entire contents of this Statement.

You should obtain this document through the legally authorized channels provided by Kyland Technology Co., Ltd.. The content of this document is regarded as the confidential information of Kyland Technology Co., Ltd., and you shall strictly abide by the confidentiality obligation; Without the prior written consent of Kyland Technology Co., Ltd., you may not disclose the contents of this Manual to or provide it to any third party for use.

1. The copyright of this manual belongs to Kyland Technology Co., Ltd.. Without prior written permission, no unit, company or individual may extract, translate or reproduce part or all of the contents of this document in any way, or disseminate and promote it in any way or manner, or distribute it for commercial purposes, etc.
2. The content of this document is subject to change due to product version upgrade, adjustment, or other reasons. Beijing Kyland Science & Technology Co., Ltd. reserves the right to modify the contents of this document without any notice or prompt, and to publish updated user documents from time to time in the channels authorized by Beijing Kyland Science & Technology Co., Ltd. You should pay attention to the version changes of the user documentation in real time and obtain the latest version of the user documentation through the authorized channels of Kyland Technology Co., Ltd..
3. This document is intended only as a reference guide for users to use the products and services of Kyland Technology Co., Ltd.. Based on existing technology, Kyland Technology Co., Ltd.. tries its best to provide relevant introduction and operation guidance. However, Kyland Technology Co., Ltd.. hereby expressly declares that the accuracy, completeness, applicability and reliability of the contents of this document are not guaranteed by any express or implied warranties. Kyland Technology Co., Ltd.. shall not assume any legal liability for any errors or economic losses caused by the use or reliance of this document by any unit, company or individual. In no event shall Beijing east earth technology corporation be liable for any indirect, consequential, exemplary, incidental, special or punitive damages, including lost profits, arising out of the user's use of or reliance on this document (even if Beijing east earth technology corporation has been

advised of the possibility of such damages).

4. If you find any technical errors or clerical errors in this document, please contact Kyland Technology Co., Ltd., and we will try our best to correct them in time.
5. Infringement shall be prosecuted.

Copyright © 2022 Kyland Technology Co., Ltd.

Notice for Safe Use

This product has good and reliable performance within the designed range of use, but it is necessary to avoid damage or destruction caused by man to the device. Before using the device, read this manual carefully to ensure the safety of the user and the device. Please keep this manual after reading for future reference. Our company does not assume any responsibility for personal injury or device damage caused by violation of safety instructions.

- Do not place or install the device near water sources or in humid places, and keep the relative humidity around the device within the range of 5% to 95% and without condensation.
- Do not place or install the device in a place with high magnetic field, strong earthquake, or high temperature. Keep the device operating and storage temperature within the specified range.
- Keep the device securely placed to prevent falling; Keep the device securely installed to prevent slippage.
- Keep the device and surrounding environment clean. Wipe with soft dry cotton cloth if necessary.
- Please do not place debris on the device or cables, keep the device heat dissipation smooth and the cables smooth and free of knots.
- Wear antistatic gloves or take other safety precautions when operating the device.
- When connecting cables, avoid exposed metal wires to prevent high temperature oxidation or combined electricity of metal wires.
- Install device in accordance with national and local electrical regulations.
- Before powering on the device, check the power specifications supported by the device to prevent the device from being damaged due to overvoltage.
- Keep the power plug and other device connectors securely connected to prevent adverse effects of contact.
- Do not remove or plug the power supply with wet hands. Do not touch the device or its components with wet hands before the power is off.
- Before operating live device, remove jewelry (rings, bracelets, watches, necklaces, etc.) or other metal objects to prevent electric shock or burns.

- Do not operate the device or connect or disconnect cables during lightning weather.
- Please use the connectors and cables approved by our marketing or technical support personnel to prevent the module functions from being affected due to the non-standard connectors and cables.
- Do not disassemble the device by yourself. If the device is faulty or suspected to be faulty, contact our marketing or technical support personnel.
- If the device components are lost, please purchase the replacement parts under the guidance of our marketing staff or technical support staff, it is strictly forbidden to choose the components by yourself.
- The device should be scrapped in accordance with relevant national regulations to reduce the pollution to the environment.

In the following cases, please disconnect the power supply immediately and contact us.

- The device is flooded.
- The device is broken or the casing is cracked.
- The device works abnormally or its performance changes.
- The device produces odor, smoke or abnormal noise.

Table of Contents

Preface.....	2
Legal Statement.....	3
1 Product Overview.....	8
2 Structure and Interface.....	10
2.1 Front panel.....	10
2.2 Side panel.....	13
2.3 Top panel.....	15
3 Installation.....	17
3.1 Dimension drawing.....	17
3.2 Installation methods and procedures.....	19
3.2.1 Clamping rail installation.....	20
3.2.2 Antenna installation and SIM card installation.....	21
4 Wire.....	23
4.1 100/1000Base-T Ethernet interface.....	23
4.2 RS-232/RS-485/CAN interface.....	24
4.3 USB connector.....	26
4.4 Video interface (HDMI interface).....	26
4.5 AUTBUS interface.....	27
4.6 Grounding.....	27
4.7 Power supply terminal.....	28
5 Reset.....	30
6 LED Indicator State.....	31
7 Basic Performance and Specifications.....	32

1 Product Overview

Kyland's new Basic Autonomous and Controllable Edge General-Purpose Controller NewPre5100, adopts 100% localized devices, pre-installed domestic channel operating system, and domestic control software MaVIEW, to create a fully localized Edge General-Purpose Controller to meet localized applications.

At the same time, NewPre5100 adopts high specification industrial design, high reliability, support local expansion IO module and communication module, can flexibly adapt to different industrial field applications.

The NewPre5100 supports clamping rail installation and the following configurations for different device types.

When the code selection is NewPre5100-P611-M2-D1-N1-W4, A maximum of four 100/1000Base-T Ethernet interfaces, one RS-232 serial interface, two RS-485 serial interfaces, two USB2.0 interfaces, one HDMI interface, one 4G antenna installation interface, one CAN interface (configuring the corresponding CAN address rotary casting switch), and one SIM card installation slot CAN be configured.

When the code selection is NewPre5100-P611-M1-D0-N1-A1, a maximum of two 100/1000Base-T Ethernet interfaces, one AUTBUS interface, two USB2.0 interfaces and one HDMI interface can be configured.

When the code selection is NewPre5100-P611-M2-D1-N1-W0, A maximum of four 100/1000Base-T Ethernet ports, one RS-232 serial interface, one RS-485 serial interface, two USB2.0 ports, one HDMI port, and two CAN interfaces CAN be configured with corresponding CAN address rotary multicast switches.

The NewPre5100 Basic Autonomous and Controllable Edge General-Purpose Controller also provides an IO module expansion slot, supporting the expansion of up to 10 KYIO modules.

Note: The IO module expansion slot is located on the right side of the power module, i.e. the expanded IO module is located between the host and the power module of the NewPre5100, and the power module is always on the far right side of the device.

The following table shows the specific configuration.

Table 1 Configuration table

Type of product	NewPre5100-P611-M2-D1-N1-W4 NewPre5100-P611-M1-D0-N1-A1 NewPre5100-P611-M2-D1-N1-W0
Code definition	Code selection
Electric port	When selecting NewPre5100-P611-M2-D1-N1-W4: 4 100/1000Base-T electric ports, RJ45 For NewPre5100-P611-M1-D0-N1-A1: 2 x 100/1000Base-T electric ports, RJ45 When selecting NewPre5100-P611-M2-D1-N1-W0: 4 100/1000Base-T electric ports, RJ45
Serial interface	When selecting NewPre5100-P611-M2-D1-N1-W4: RS232 x 1, RS485 x 2 When selecting NewPre5100-P611-M2-D1-N1-W0: RS232 x 1, RS485 x 1
CAN interface	When selecting NewPre5100-P611-M2-D1-N1-W4: 1 CAN interface (screen printing is CAN) When selecting NewPre5100-P611-M2-D1-N1-W0: 2 CAN interfaces (screen printing is CAN1 and CAN2)
AUTBUS interface	1 AUTBUS interface (available only when NewPre5100-P611-M1-D0-N1-A1 is selected)
USB Connector	2 USB2.0
Antenna interface	One 4G antenna installation interface (available only when selecting NewPre5100-P611-M2-D1-N1-W4)
Other interfaces	One SIM card installation slot (available only when selecting NewPre5100-P611-M2-D1-N1-W4)
Operating temperature	-40°C~+70°C
Power Input	Terminal interface: 24V+, 24V-: 24V voltage input

2 Structure and Interface



Note:

In order to maintain the cleanliness of the interface and to protect the operational performance of the device, it is recommended that users order a separate interface dust cover (optional) according to the form of the device interface.

2.1 Front panel

- Basic Autonomous and Controllable Edge General-Purpose Controller
NewPre5100-P611-M2-D1-N1-W4 front panel

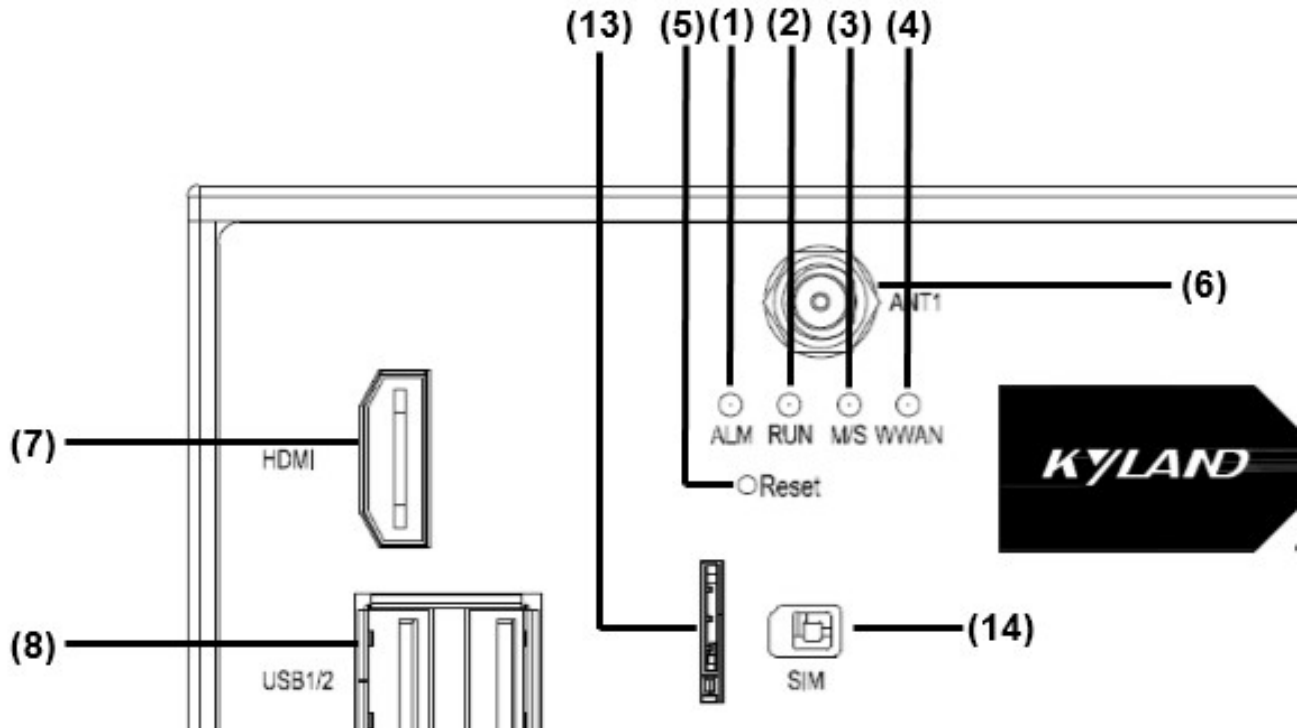

Figure 1 NewPre5100-P611-M2-D1-N1-W4 front panel labeling diagram

Table 2 NewPre5100-P611-M2-D1-N1-W4 front panel labeling instructions

No.	Identification	Description
(1)	ALM	Alarm indicator
(2)	RUN	Operation indicator
(3)	MS	Master/slave communication state indicator
(4)	WWAN	Wireless communication state indicator
(5)	Reset	Reset button
(6)	AT1	4G antenna installation interface

(7)	HDMI	HDMI display interface
(8)	USB1/2	USB2.0 communication interfaces 1 to 2
(9)	GE1/2	100/1000Base-T Ethernet communication interfaces 1 to 2
(10)	GE3/4	100/1000Base-T Ethernet communication interfaces 3 to 4
(11)	--	100/1000Base-T Ethernet communication interface rate indicator (yellow)
(12)	--	100/1000Base-T Ethernet communication interface connection state indicator (green)
(13)	--	SIM card slot
(14)	SIM	SIM card insertion mark, prompting users to use the SIM card metal IC part upward insert
(15)	485-1/485-2	RS-485 communication interface 1 or 2
(16)	232	RS-232 communication interface
(17)	CAN	CAN communication interface
(18)	Address	CAN address rotary multicast switch
(19)	24V/12V	Power indicator
(20)	--	Power interface 24V

- Basic Autonomous and Controllable Edge General-Purpose Controller
NewPre5100-P611-M1-D0-N1-A1 front panel

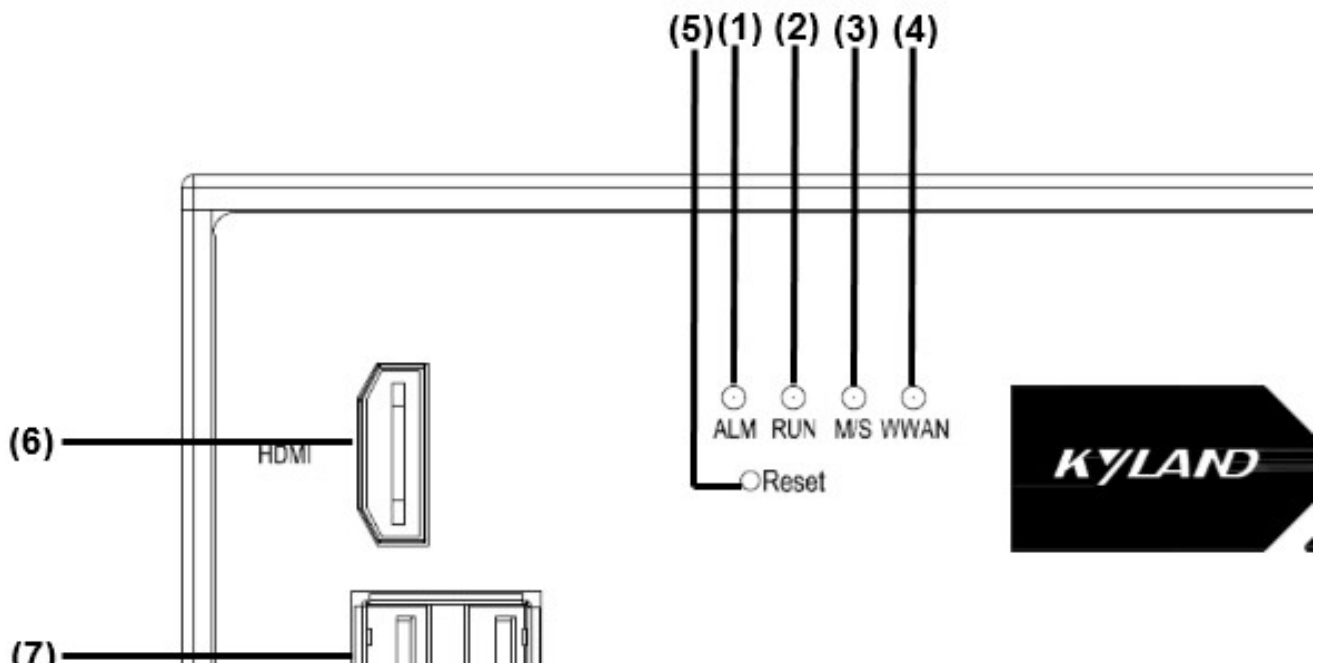

Figure 2 NewPre5100-P611-M1-D0-N1-A1 front panel labeling diagram

Table 3 NewPre5100-P611-M1-D0-N1-A1 front panel labeling instructions

No.	Identification	Description
-----	----------------	-------------

(1)	ALM	Alarm indicator
(2)	RUN	Operation indicator
(3)	MS	Master/slave communication state indicator
(4)	WWAN	Wireless communication state indicator
(5)	Reset	Reset button
(6)	HDMI	HDMI display interface
(7)	USB1/2	USB2.0 communication interfaces 1 to 2
(8)	GE1/2	100/1000Base-T Ethernet communication interfaces 1 to 2
(9)	--	100/1000Base-T Ethernet communication interface rate indicator (yellow)
(10)	--	100/1000Base-T Ethernet communication interface connection state indicator (green)
(11)	AUTBUS	AUTBUS communication interface
(12)	RUN	AUTBUS communication interface operation indicator
(13)	LINK	AUTBUS communication interface state indicator
(14)	24V/12V	Power indicator
(15)	--	Power interface 24V

● Basic Autonomous and Controllable Edge General-Purpose Controller
NewPre5100-P611-M2-D1-N1-W0 Front Panel

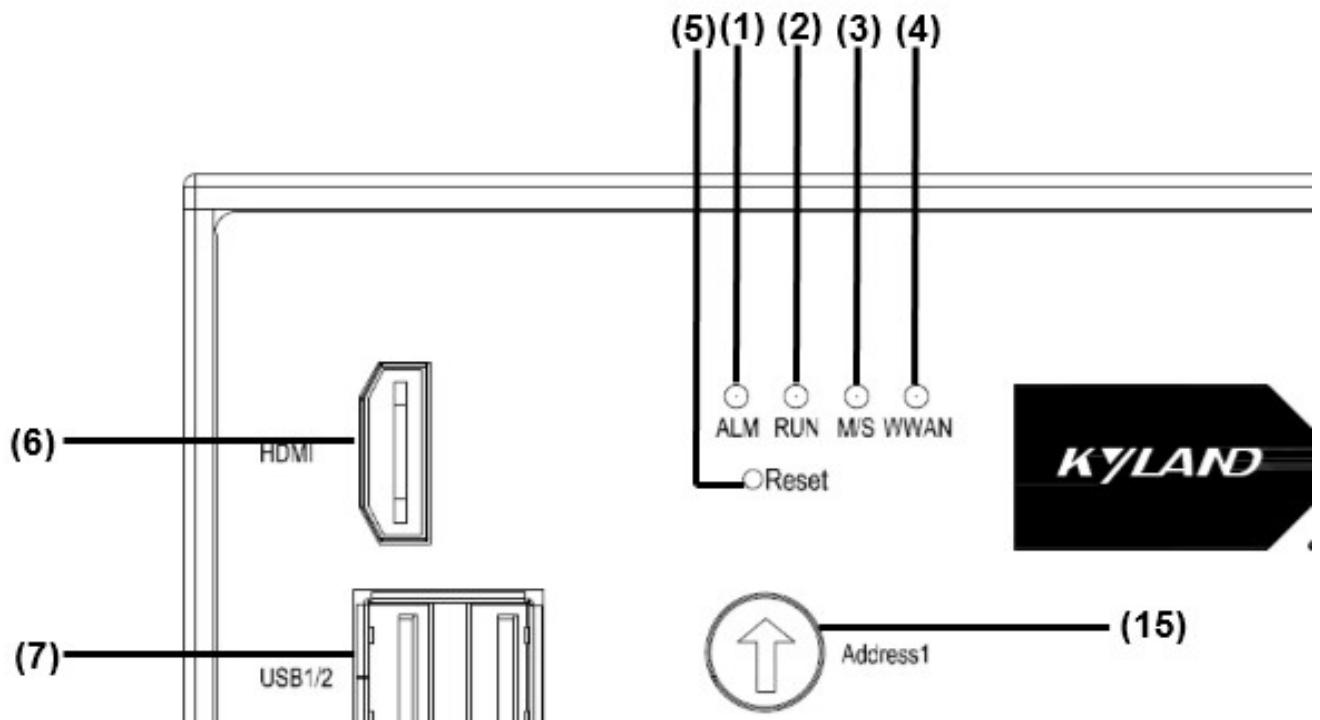

Figure 3 NewPre5100-P611-M2-D1-N1-W0 front panel labeling diagram

Table 4 NewPre5100-P611-M2-D1-N1-W0 front panel labeling instructions

No.	Identification	Description
(1)	ALM	Alarm indicator
(2)	RUN	Operation indicator
(3)	MS	Master/slave communication state indicator
(4)	WWAN	Wireless communication state indicator
(5)	Reset	Reset button
(6)	HDMI	HDMI display interface
(7)	USB1/2	USB2.0 communication interfaces 1 to 2
(8)	GE1/2	100/1000Base-T Ethernet communication interfaces 1 to 2
(9)	GE3/4	100/1000Base-T Ethernet communication interfaces 3 to 4
(10)	--	100/1000Base-T Ethernet communication interface rate indicator (yellow)
(11)	--	100/1000Base-T Ethernet communication interface connection state indicator (green)
(12)	485	RS-485 communication interface
(13)	232	RS-232 communication interface
(14)	CAN1/CAN2	CAN communication interfaces 1 to 2
(15)	Address1	CAN1 address rotary casting switch
(16)	Address2	CAN2 address rotary casting switch
(17)	24V/12V	Power indicator
(18)	--	Power interface 24V

2.2 Side panel

- Basic Autonomous and Controllable Edge General-Purpose Controller
NewPre5100-P611-M2-D1-N1-W4 side panel

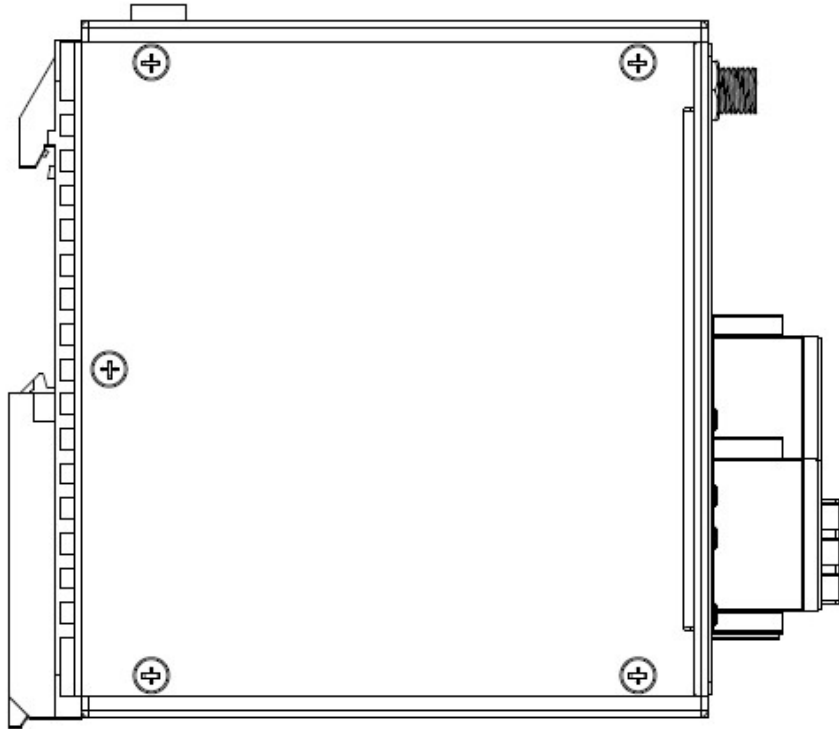

Figure 4 NewPre5100-P611-M2-D1-N1-W4 side panel labeling diagram

- Basic Autonomous and Controllable Edge General-Purpose Controller
NewPre5100-P611-M1-D0-N1-A1 and NewPre5100-P611-M2-D1-N1-W0 side panel

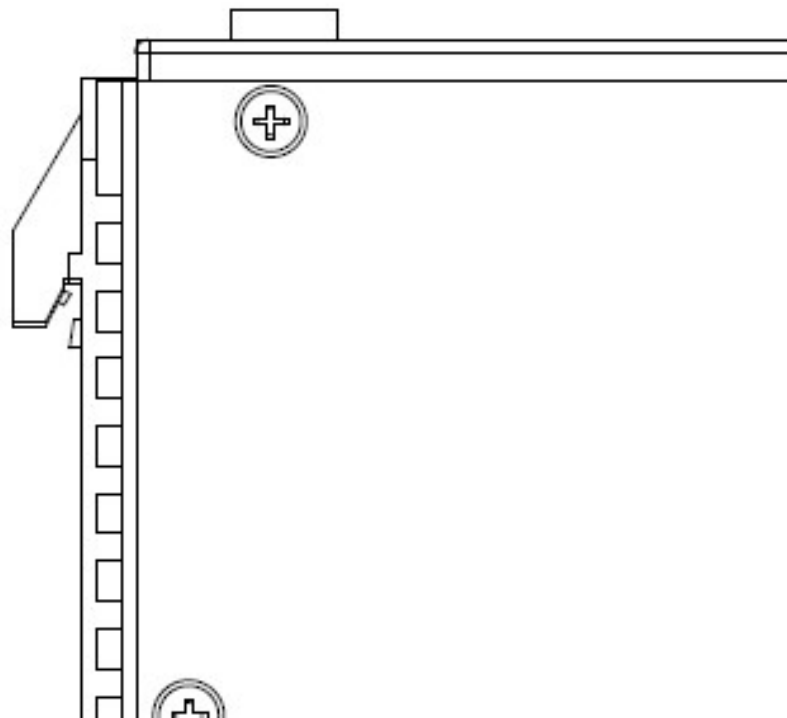

Figure 5 NewPre5100-P611-M1-D0-N1-A1 和 NewPre5100-P611-M2-D1-N1-W0 side panel labeling diagram

2.3 Top panel

- Basic Autonomous and Controllable Edge General-Purpose Controller
NewPre5100-P611-M2-D1-N1-W4 top panel

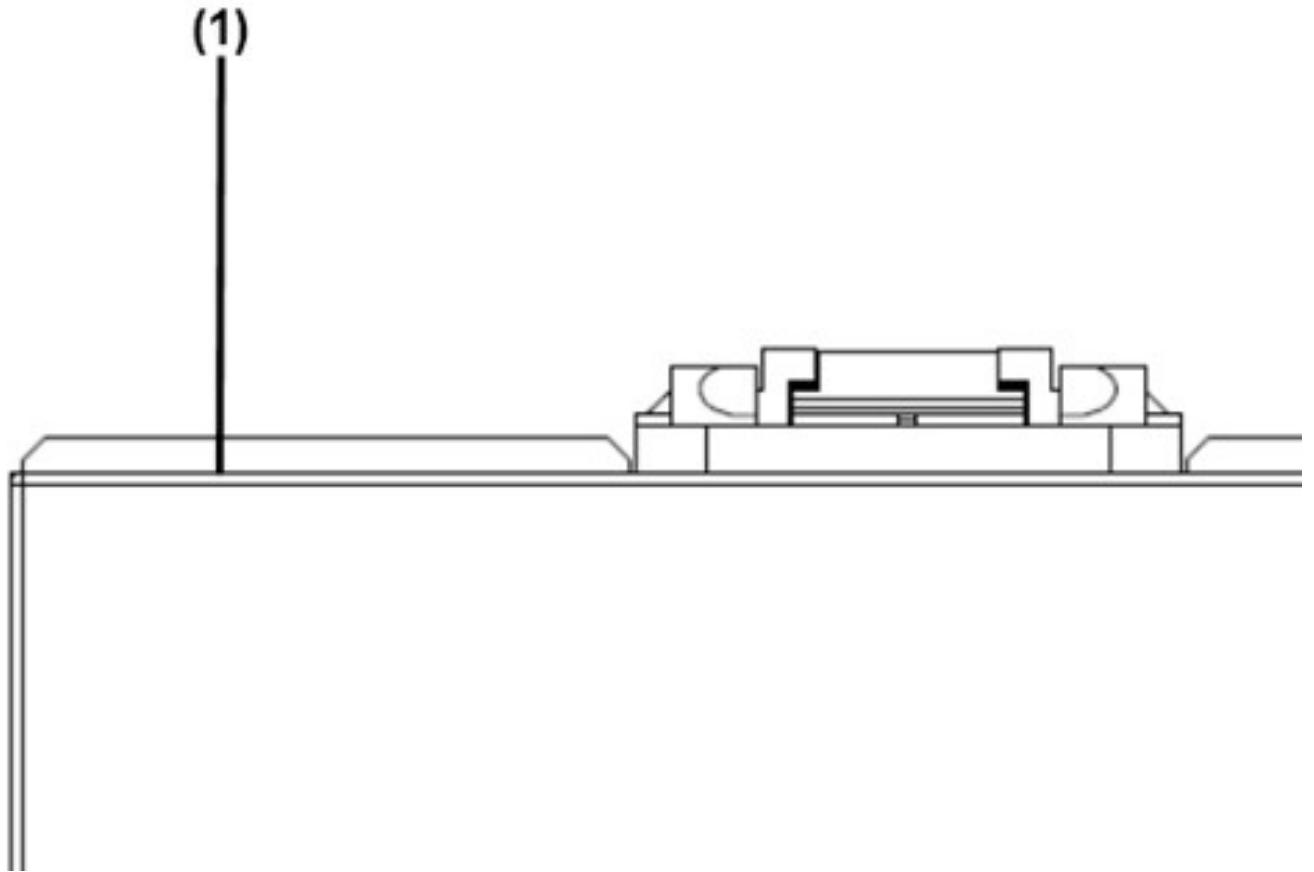

Figure 6 NewPre5100-P611-M2-D1-N1-W4 top panel labeling diagram

- Basic Autonomous and Controllable Edge General-Purpose Controller
NewPre5100-P611-M1-D0-N1-A1 and NewPre5100-P611-M2-D1-N1-W0 top panel

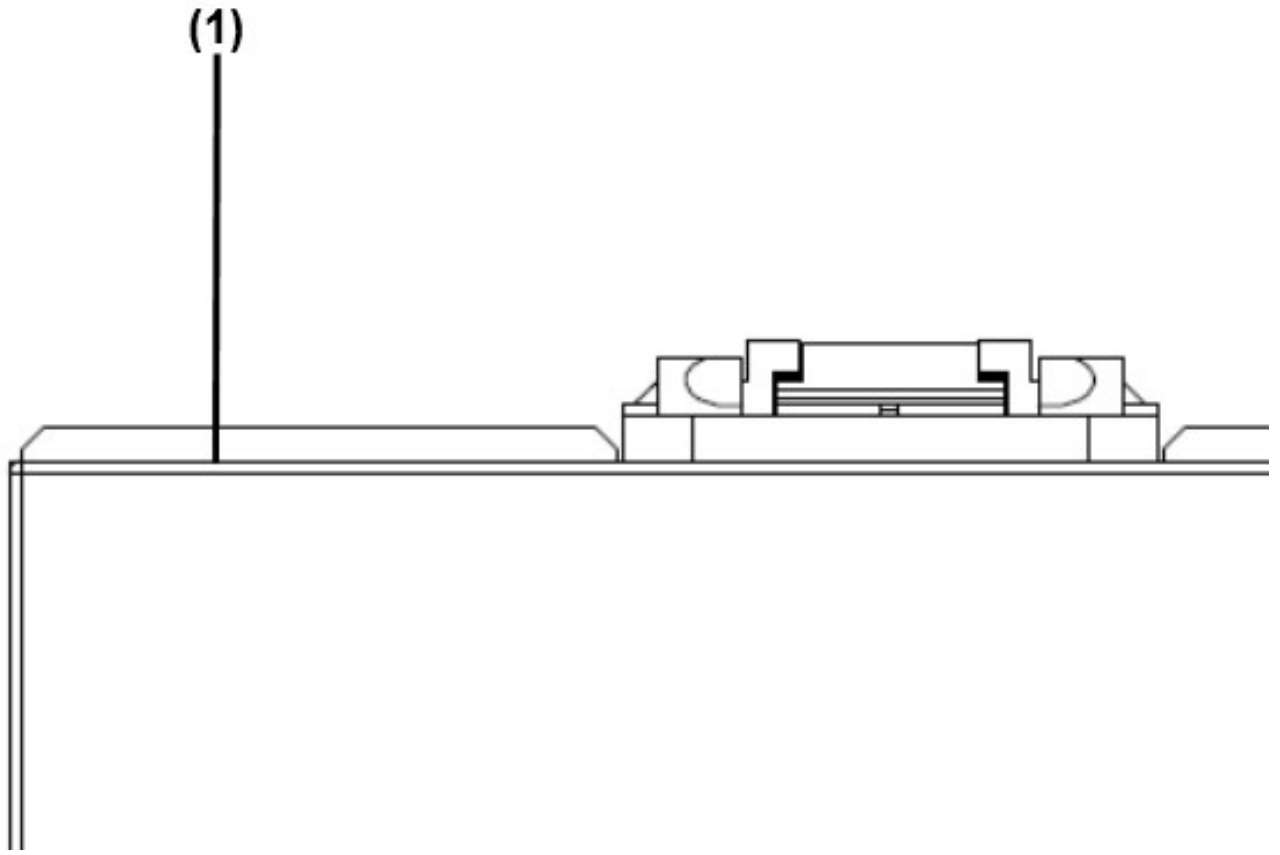

Figure 7 NewPre5100-P611-M1-D0-N1-A1 和 NewPre5100-P611-M2-D1-N1-W0Top panel labeling diagram

Table 5 NewPre5100 series top panel labeling instructions

No.	Identification	Description
(1)	--	Device host part
(2)	--	Power supply part of device
(3)	--	Power supply terminal
(4)	--	Grounding screw

3 Installation

3.1 Dimension drawing

- Basic Autonomous and Controllable Edge General-Purpose Controller
NewPre5100-P611-M2-D1-N1-W4

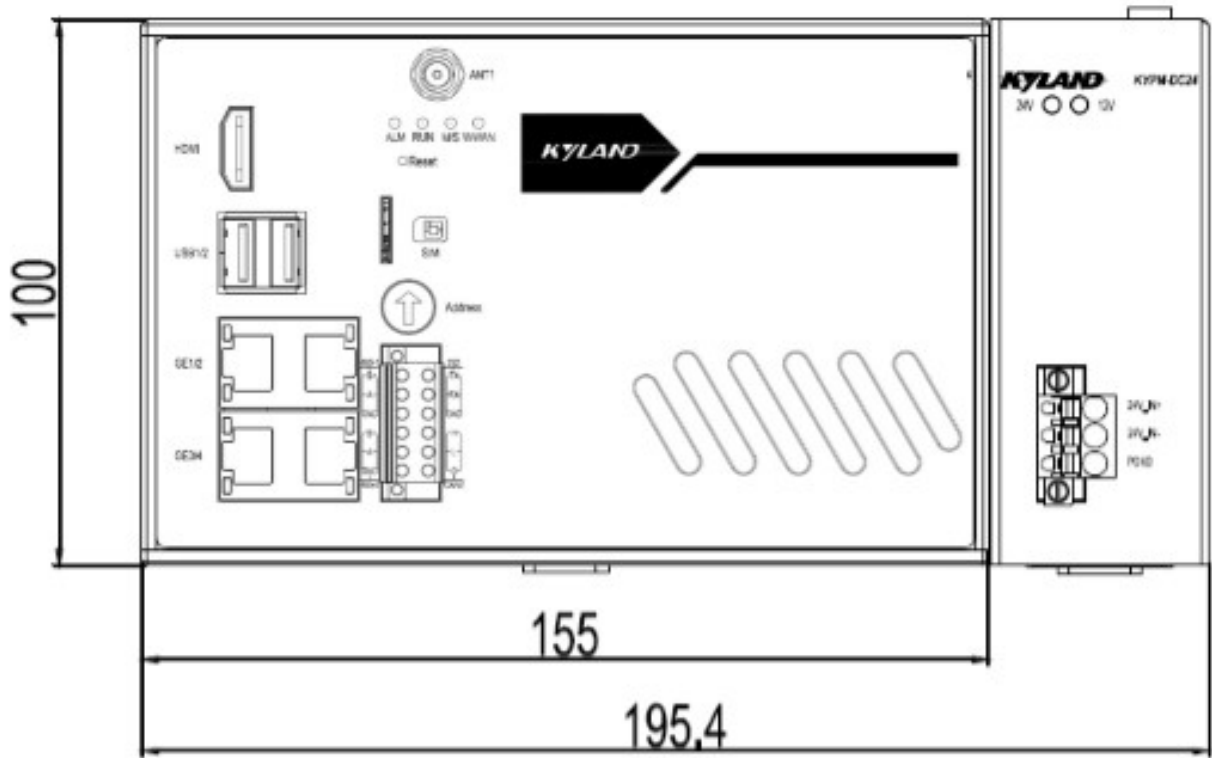

Figure 8 NewPre5100-P611-M2-D1-N1-W4 installation dimension drawing (Unit: mm)

- Basic Autonomous and Controllable Edge General-Purpose Controller
NewPre5100-P611-M1-D0-N1-A1

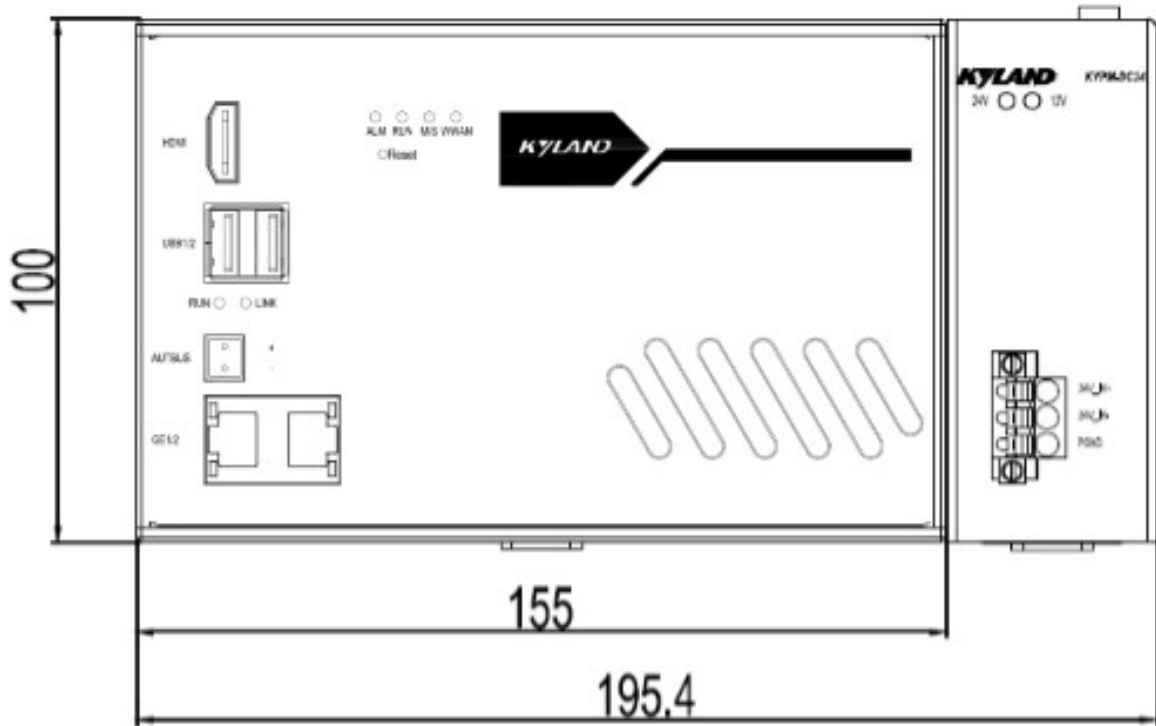

Figure 9 NewPre5100-P611-M1-D0-N1-A1 installation dimension drawing (Unit: mm)

- Basic Autonomous and Controllable Edge General-Purpose Controller
NewPre5100-P611-M2-D1-N1-W0

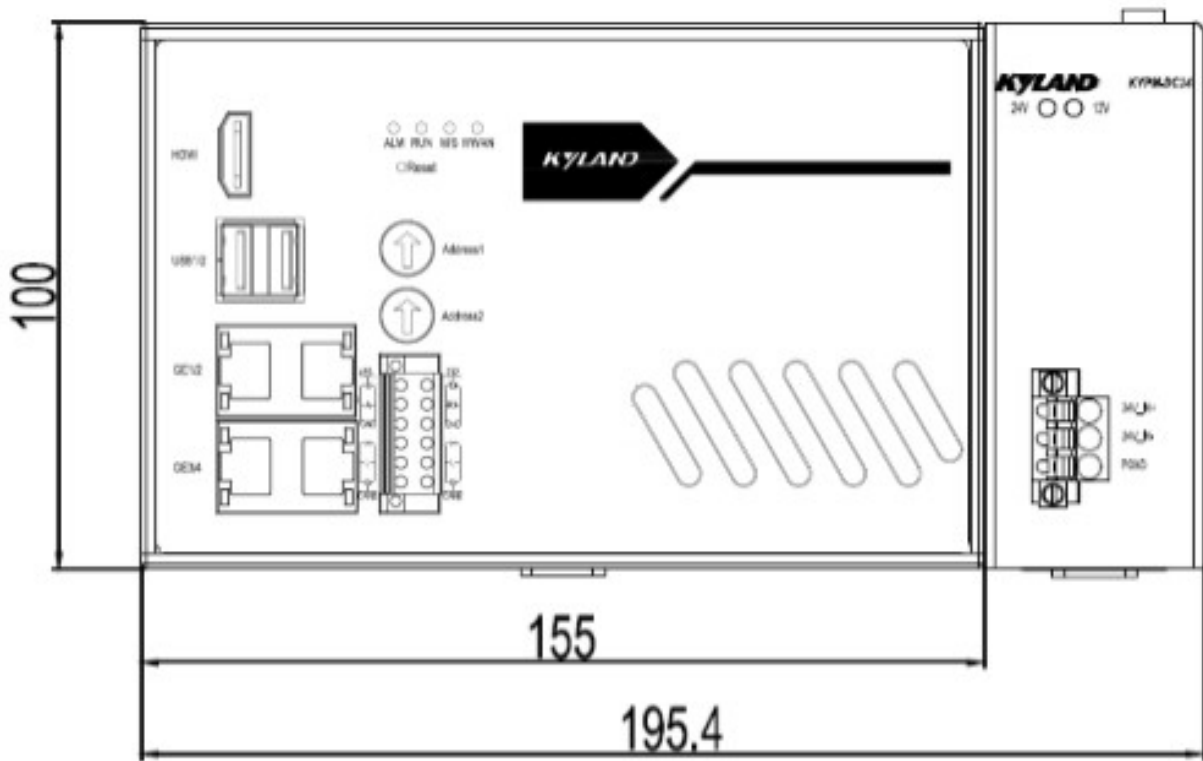

Figure 10 NewPre5100-P611-M2-D1-N1-W0 installation dimension drawing (Unit: mm)



Note:

- The device casing is part of the whole machine cooling system, the casing will be hot during normal operation, please do not cover the casing when the device is working.
- The pictures in this manual are schematic drawings. For details, refer to the actual objects.

3.2 Installation methods and procedures

The device supports wall-mounted installation. Before installing the device, confirm the following installation requirements:

- 1) Environment requirements: Operating temperature -40°C to $+75^{\circ}\text{C}$, storage temperature -40°C to $+85^{\circ}\text{C}$, relative humidity 5% to 95% (no condensation).
- 2) Power supply requirements: Ensure that the working voltage is consistent with the voltage range marked on the device.
- 3) Grounding resistance requirements: <5 .
- 4) Avoid direct sunlight, away from heat sources or areas with strong electromagnetic

interference.

5) The installation environment should meet the requirements of the authority. Do not touch the device directly with your hands to avoid personal injury.

6) Only professionals or trained and qualified personnel can install, replace and maintain the device.

3.2.1 Clamping rail installation



Description:

- The device is shipped by default without the configuration of the clamping rail base, the user needs to order a separate clamping rail base (optional).
- The host part, power supply part, and expandable KYIO module of the device are all installed in clamping rails. Therefore, this section uses the power supply part as an example to describe how to install and remove the clamping rails.

● Clamping rail installation

Step 1. Determine the installation position of the device and ensure that the installation space is sufficient and the heat dissipation is smooth.

Step 2: Snap the upper part of the clamping rail base onto the DIN rail, apply slight pressure upward on the lower end of the device, and turn the device according to the arrow 2 pointing in the figure below until the device is reliably mounted onto the DIN rail to complete the installation.

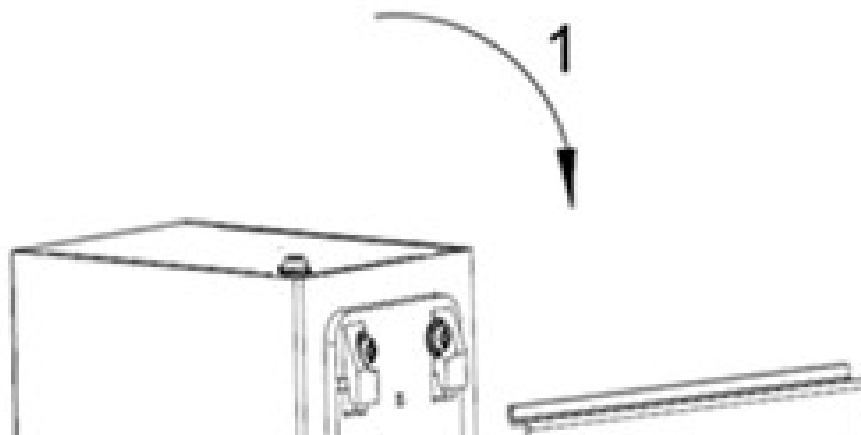

Figure 11 Installation of the clamping rail

● Clamping rail removal

Step 1. As shown on the left of the following figure, insert the screwdriver head into the hole at the lower part of the spring lock piece, lift the screw handle upward, and open the spring lock piece of the DIN clamping rail base.

Step 2. Turn the device in the direction of arrow 2 in the figure below, turn and lift the device upward in the direction of arrow 3 after the lower end of the device is free from the DIN rail, until the upper end of the DIN clamping rail base is free from the DIN rail to complete the disassembly.

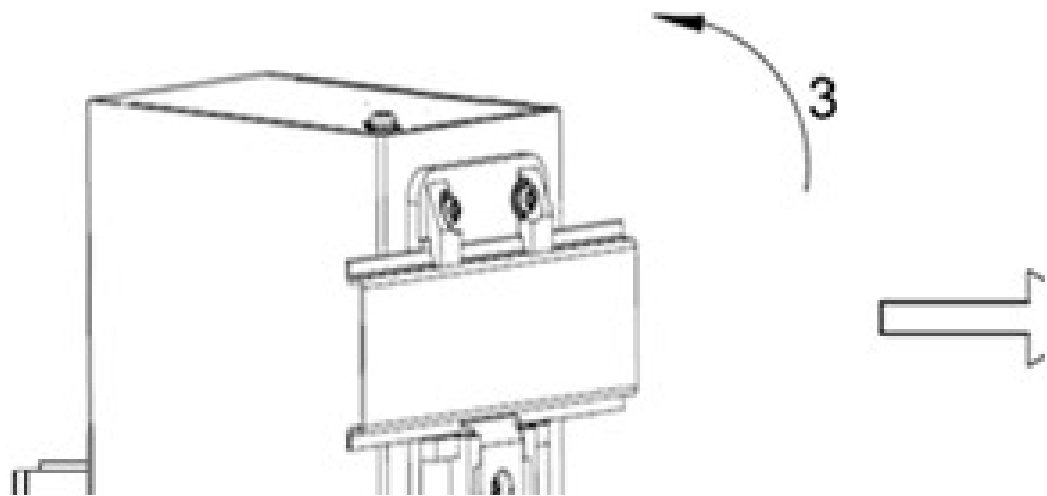

Figure 12 clamping rail removal diagram

3.2.2 Antenna installation and SIM card installation



Description:

The antenna and SIM card installation operation is required only for the NewPre5100-P611-M2-D1-N1-W4 option.

- Antenna installation

Step 1. Obtain the corresponding antenna accessories in the product.

Step 2. Rotate the antenna fittings clockwise and tighten them to the antenna installation interface.

- SIM card installation

Step 1. Obtain the SIM card for installation.

Step 2. Insert the SIM card into the SIM card installation slot with the metal IC part upwards in the correct direction of the SIM card insertion mark.



Note:

Before installing, removing, or moving a device, disconnect the power supply and remove all cables.

4 Wire

4.1 100/1000Base-T Ethernet interface

The 10/100Base-T(X) Ethernet interface adopts standard RJ45 connector with adaptive function, which can be automatically configured to 10M/100M state and full-duplex/half-duplex operation mode, and supports MDI/MDI-X self-identification function of the cable, i.e. it can be connected with terminal device and network device using either direct network cable or crossover network cable.

- Interface definition

RJ45 interface pin numbers are shown in the following figure.

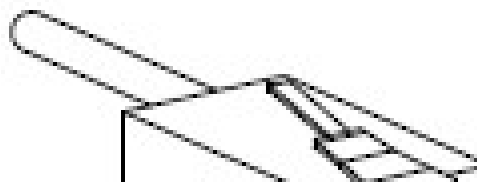



Figure 13 RJ45 interface pin numbers

Table 6 100/1000Base-T RJ45 interface pins definition

Pin	MDI-X	MDI
1	Send/receive data (TRD1+)	Send/receive data (TRD0+)
2	Send/receive data (TRD1-)	Send/receive data (TRD0-)
3	Send/receive data (TRD0+)	Send/receive data (TRD1+)
4	Send/receive data (TRD3+)	Send/receive data (TRD2+)
5	Send/receive data (TRD3-)	Send/receive data (TRD2-)
6	Send/receive data (TRD0-)	Send/receive data (TRD1-)
7	Send/receive data (TRD2+)	Send/receive data (TRD3+)
8	Send/receive data (TRD2-)	Send/receive data (TRD3-)

 Description:
"+" "-" indicate the level polarity.

- Connector line sequence

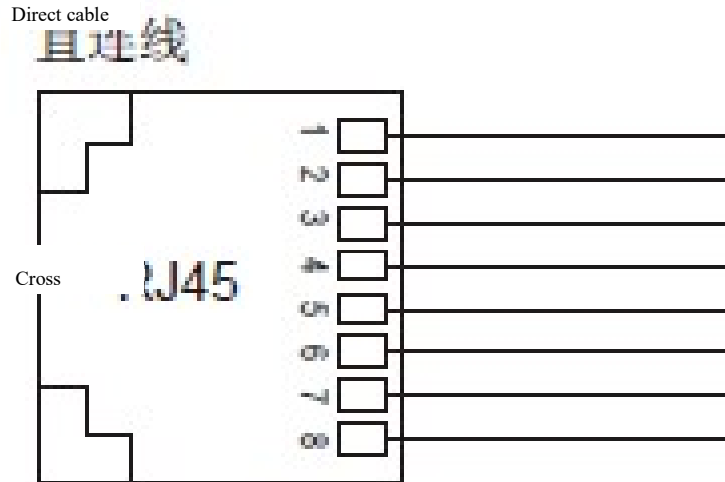

Figure 14 100/1000Base-T RJ45 connector direct and cross cable interconnection



Description:

RJ45 connectors are wired as standard 568B (1-orange white, 2-orange, 3-green white, 4-blue, 5-blue white, 6-green, 7-brown white, 8-brown).

4.2 RS-232/RS-485/CAN interface

RS-232/RS-485/CAN pins are defined as follows.

- RS-232/RS-485/CAN interface pin definition of Basic Autonomous and Controllable Edge General-Purpose Controller NewPre5100-P611-M2-D1-N1-W4

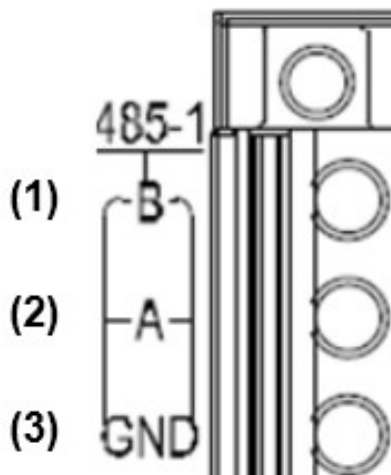

Figure 15 Interface pin definition

Table 7 Serial interface pin definition

Pin	RS-232	RS-485-1/RS-485-2	CAN
1	TX	B	H
2	RX	A	L
3	GND	GND	G
4	Not involved	B	Not involved
5	Not involved	A	Not involved
6	Not involved	GND	Not involved



Description:

In interface RS-485, pins 1 to 3 are way-1, and pins 4 to 6 are way-2.

- RS-232/RS-485/CAN interface pin definition of Basic Autonomous and Controllable Edge General-Purpose Controller NewPre5100-P611-M2-D1-N1-W0

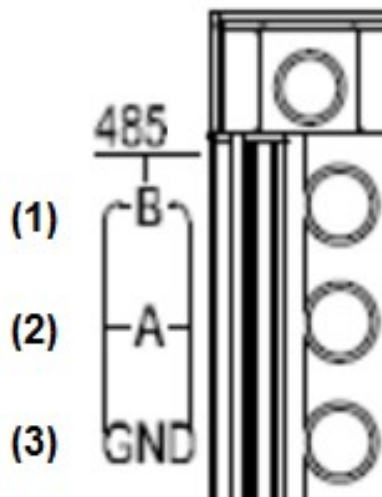

Figure 16 Interface pin definition

Table 8 Serial interface pin definition

Pin	RS-232	RS-485	CAN1/CAN2
1	TX	B	H
2	RX	A	L
3	GND	GND	G
4	Not involved	Not involved	H
5	Not involved	Not involved	L
6	Not involved	Not involved	G



Description:

In the CAN interface, pins 1~3 are way-1 and pins 4~6 are way-2.

4.3 USB connector

The USB interface is located on the front panel of the device and contains two USB2.0 ports, both of which use standard A female ports. USB interface pins are defined as shown in the figure below.

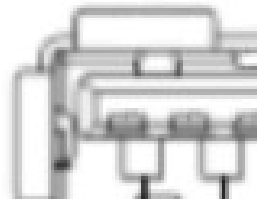

Figure 17 USB2.0 interface pin numbers

Table 9 USB2.0 interface pin definitions

USB pin	Definition	USB pin	Definition
1	VBUS	2	D-
3	D+	4	GND

4.4 Video interface (HDMI interface)

The HDMI interface uses a standard HDMI connector interface and can support up to 1080P HD display. HDMI interface pins are defined as shown in the following figure.

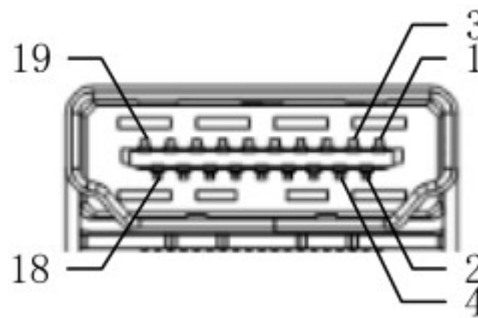

Figure 18 HDMI interface pin numbers

Table 10 HDMI interface pin definition

HDMI pin	Definition	HDMI pin	Definition
1	TMDS_Data2+	2	GND
3	TMDS_Data2-	4	TMDS_Data1+
5	GND	6	TMDS_Data1-

7	TMDS_Data0+	8	GND
9	TMDS_Data0-	10	TMDS_Clock+
11	GND	12	TMDS_Clock-
13	NC	14	NC
15	SCL	16	SDA
17	GND	18	+5V
19	Hot plug detect		

4.5 AUTBUS interface

The AUTBUS interface pin is defined as follows (available only when selecting NewPre5100-P611-M1-D0-N1-A1).

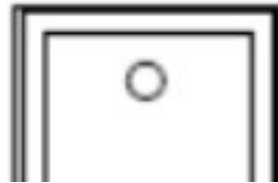

Figure 19 AUTBUS interface pin definition

Table 11 AUTBUS interface pin definition

Pin	Display	Definition
1	+	Positive end of interface
2	-	Negative end of interface

It supports the use of shielded twisted pair cable to connect to the positive and negative ends of the interface respectively to complete the connection.

4.6 Grounding

The device is properly grounded to protect the device from lightning and interference. Therefore, you must properly connect the grounding screw. Ground the device before powering on, and disconnect the grounding screw after powering off the device.

There is a ground screw on the cover plate of the device, that is, the grounding screw of the housing, which is called the "casing ground". One end of the grounding screw is crimped to the cold crimp terminal and fixed with grounding screw at the "casing ground", and the other end of the grounding screw is reliably connected to the earth.



Description:

Grounding screw cross-sectional area of 2.5mm² or more; grounding resistance requirements: <5.

4.7 Power supply terminal

The power supply terminal is located on the front panel of the device and connects to the power cable to supply power to the device. This series of devices support redundant power input and use 3-core 5.08mm spacing plug out wiring terminals.



Description:

- Power cord cross-sectional area of 0.75 mm² or more (wiring maximum cross-sectional area of 2.5 mm²); grounding resistance requirements: <5Ω.
- Copper conductors must be used for onsite cable connections, and the temperature must meet 75 ° C.

- 3-core 5.08mm spacing plug out wiring terminals

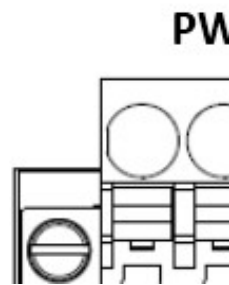

Figure 20 3-core 5.08mm spacing plug out wiring terminals (socket)

Table 12 3-core 5.08mm spacing plug out wiring terminals definition

Terminal number	Signal name	DC wire definition	AC wire definition
1	24V_IN+	PWR: +	PWR: IN
2	24V_IN-	PWR: -	PWR: IN
3	PGND	PGND protected ground	PGND protected ground

- Wire and installation
 - Step 1. Properly ground the device according to the grounding procedure.
 - Step 2. Remove the power supply terminal plug from the device.
 - Step 3. Insert one end of the power cord into the power supply terminal plug and secure the

power cord according to Table 12.

Step 4. Plug the connected power cord back into the corresponding power supply terminal socket of the device.

Step 5. Connect the other end of the power cable to the corresponding external power supply system according to the power supply requirements marked on the device. Check whether the corresponding power indicator of the device is on.

Wire and installation should meet the following specifications.

Table 13 Wire and installation specifications

Classification of terminal	Torque requirements	Wire cross-sectional area (AWG)
Plug out terminals	4.5-5.0 lb-in	12-24



Note:

Before connecting to the power supply, please confirm that the power supply matches the power supply requirements marked on the device to avoid damage to the device.



Warning:

- Do not touch any exposed wires, terminals and dangerous voltage marks marked on the product to avoid injury to human body.
 - Do not disassemble components or plug and unplug connectors during the powering on process
-

5 Reset

The Reset button is located on the front panel of the device and has the function of rebooting and restoring the default configuration. Press the reset button for 0.5~3 seconds and then release it to complete the device restart. Keep pressing the reset button for more than 3 seconds and release it to restore the default configuration and restart.



Note:

If you want to reboot the device, be careful not to press the reset button for more than 3 seconds to prevent the device from reverting to its default configuration.

6 LED Indicator State

Table 14 Description of indicators on the front panel

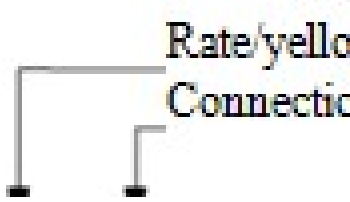
LED	State	Description
Power indicator /24V (green)	Steady on	The input power supply is connected and the 24V power supply works properly
	Flashing	The 24V power supply does not work properly
	Off	The input power is not connected or the 24V power supply is not working properly
Power indicator /12V (green)	Steady on	The input power supply is connected and the 12V power supply is working properly
	Flashing	The 12V power supply is not working properly
	Off	The input power is not connected or the 12V power supply is not working properly
Operation indicator (green)	Flashing	The motherboard CPU is running normally
	Steady on	The device is being powered on and started. Procedure
	Off	The motherboard CPU does not start or runs in an abnormal state
Master/slave state indicator (green)	On	The device is a host in the two-node cluster state
	Off	The device is a slave in the two-node cluster state
Wireless communication state indicator (green)	Slow flash	The wireless module is present and in network finding or standby state
	Fast flash	The wireless module is in data transmission mode
	Off	Wireless module does not exist or is not operating properly
Alarm indicator (red)	On	System alarm display
	Off	No system alarm display
		
100/1000Base-T Ethernet interface rate indicator (yellow)	On	1000M working state (1000Base-T)
	Off	100M working state (100Base-T) or no connection
100/1000Base-T Ethernet interface connection state indicator (green)	On	The interface has a valid network connection
	Flashing	The interface has network activity
	Off	The interface doesn't have a valid network connection
AUTBUS communication interface operation indicator	On	The interface function operates normally
	Off	The interface function operates abnormally or malfunctions
AUTBUS communication interface state indicator	On	Interface signal synchronization completed
	Off	Interface signals not synchronized

7 Basic Performance and Specifications

Power supply		
Power supply identification	Input rated voltage range	Input maximum voltage range
L2	24VDC	18-36VDC
Access terminal	Three-core 5.08mm spacing plug out wiring terminals	
Nominal power		
Nominal power	20W	
Mechanical structure		
Casing	All-metal unibody, fanless (aluminum housing, host and power module detachable)	
Degree of protection	IP40	
Installation method	DIN clamping rail installation	
Dimension (W×H×D)	195.4mm x 100mm x 94mm (excluding connector protruding and DIN clamping rail assembly dimensions, including power module)	
Dimension	1.77KG (including power module)	
Environment		
Operating temperature	-40°C~+75°C	
Storage temperature	-40°C~+85°C	
Relative humidity:	5% to 95% no condensation	
Warranty period		
Warranty period	2 years	