



16x16 Modular Matrix Switch

VM1600

User Manual

4-Port 3G-SDI Input Board

VM7404

4-Port HDBaseT Input / Output Board

VM7514 / VM8514

4-Port HDMI Input / Output Board

VM7804 / VM8804

4-Port DVI Input / Output Board

VM7604 / VM8604

4-Port VGA Input Board

VM7104

HDMI HDBaseT Lite Receiver with Scaler

VE805R

EMC Information

FEDERAL COMMUNICATIONS COMMISSION INTERFERENCE STATEMENT

This equipment has been tested and found to comply with the limits for a Class A digital device, pursuant to Part 15 of the FCC Rules. These limits are designed to provide reasonable protection against harmful interference when the equipment is operated in a commercial environment. This equipment generates, uses, and can radiate radio frequency energy and, if not installed and used in accordance with the instruction manual, may cause harmful interference to radio communications. Operation of this equipment in a residential area is likely to cause harmful interference in which case the user will be required to correct the interference at his own expense.

The device complies with Part 15 of the FCC Rules. Operation is subject to the following two conditions: (1) this device may not cause harmful interference, and (2) this device must accept any interference received, including interference that may cause undesired operation.

FCC Caution: Any changes or modifications not expressly approved by the party responsible for compliance could void the user's authority to operate this equipment.

Warning: This equipment is compliant with Class A of CISPR 32. In a residential environment, this equipment may cause radio interference.

KC Information: 이 기기는 업무용 (A 급) 전자파 적합기기로서 판매자 또는 사용자는 이점을 주의하시기 바라며, 가정외의 지역에서 사용하는 것을 목적으로 합니다.

RoHS

This product is RoHS compliant.

Safety

This product has been classified as Information Technology Equipment.

SJ/T 11364-2006

The following contains information that relates to China.

部件名称	有毒有害物质或元素					
	铅	汞	镉	六价铬	多溴联苯	多溴二苯醚
电器部件	●	○	○	○	○	○
机构部件	○	○	○	○	○	○

- : 表示该有毒有害物质在该部件所有均质材料中的含量均在SJ/T 11363-2006规定的限量要求之下。
- : 表示符合欧盟的豁免条款, 但该有毒有害物质至少在该部件的某一均质材料中的含量超出SJ/T 11363-2006的限量要求。
- ×: 表示该有毒有害物质至少在该部件的某一均质材料中的含量超出SJ/T 11363-2006的限量要求。



User Information

Online Registration

Be sure to register your product at our online support center:

International	http://eservice.aten.com
---------------	---

Telephone Support

For telephone support, call this number:

International	886-2-8692-6959
China	86-400-810-0-810
Japan	81-3-5615-5811
Korea	82-2-467-6789
North America	1-888-999-ATEN ext 4988
United Kingdom	44-8-4481-58923

User Notice

All information, documentation, and specifications contained in this manual are subject to change without prior notification by the manufacturer. The manufacturer makes no representations or warranties, either expressed or implied, with respect to the contents hereof and specifically disclaims any warranties as to merchantability or fitness for any particular purpose. Any of the manufacturer's software described in this manual is sold or licensed *as is*. Should the programs prove defective following their purchase, the buyer (and not the manufacturer, its distributor, or its dealer), assumes the entire cost of all necessary servicing, repair and any incidental or consequential damages resulting from any defect in the software.

The manufacturer of this system is not responsible for any radio and/or TV interference caused by unauthorized modifications to this device. It is the responsibility of the user to correct such interference.

The manufacturer is not responsible for any damage incurred in the operation of this system if the correct operational voltage setting was not selected prior to operation. PLEASE VERIFY THAT THE VOLTAGE SETTING IS CORRECT BEFORE USE.

Package Contents

VM1600

The VM1600 package consists of:

- ◆ 1 VM1600 Modular Matrix Switch
- ◆ 1 Power Cord
- ◆ 1 Terminal Block connector
- ◆ 1 Fan Module (pluggable)
- ◆ 1 Power Module (pluggable)
- ◆ 1 User Instructions*

VM7404

The 4-Port 3G-SDI Input Board package consists of:

- ◆ 1 VM7404 4-Port 3G-SDI Input Board
- ◆ 4 Terminal Block connectors
- ◆ 1 User Instructions*

VM7514 / VM8514

The 4-Port HDBaseT Input / Output Board package consists of:

- ◆ 1 VM7514 4-Port HDBaseT Input Board
- ◆ 1 VM8514 4-Port HDBaseT Output Board
- ◆ 4 Terminal Block connectors
- ◆ 1 IR Transmitter
- ◆ 1 IR Receiver
- ◆ 1 User Instructions*

VM7804 / VM8804

The 4-Port HDMI Input / Output Board package consists of:

- ◆ 1 VM7804 4-Port HDMI Input Board
- ◆ 1 VM8804 4-Port HDMI Output Board
- ◆ 4 Terminal Block connectors
- ◆ 1 User Instructions*

VM7604 / VM8604

The 4-Port DVI Input / Output Board package consists of:

- ◆ 1 VM7604 4-Port DVI Input Board
- ◆ 1 VM8604 4-Port DVI Output Board
- ◆ 4 Terminal Block connectors
- ◆ 1 User Instructions*

VM7104

The 4-Port VGA Input Board package consists of:

- ◆ 1 VM7104 4-Port VGA Input Board
- ◆ 4 Terminal Block connectors
- ◆ 1 User Instructions*

VE805R

The HDMI HDBaseT Lite Receiver with Scaler package consists of:

- ◆ 1 VE805R HDMI HDBaseT Lite Receiver with Scaler
- ◆ 1 Power Adapter
- ◆ 1 Terminal Block connectors
- ◆ 1 IR Transmitter
- ◆ 1 IR Receiver
- ◆ 1 User Instructions*

Check to make sure that all components are present and that nothing was damaged in shipping. If you encounter a problem, contact your dealer. Read this manual thoroughly and follow the installation and operation procedures carefully to prevent any damage to the unit, and/or any of the devices connected to it.

* Features may have been added to the VM1600 / VM7404 / VM7514 / VM8514 / VM7804 / VM8804 / VM7604 / VM8604 / VM7104 / VE805R since this manual was published. Please visit our website to download the most up-to-date version.

© Copyright 2016 ATEN® International Co., Ltd.

Manual Date: 2016-07-21

VM1600 F/W Version: 1.5.145

VM8514 F/W Version: 1.0.069

VM7514 F/W Version: 1.0.066

ATEN and the ATEN logo are registered trademarks of ATEN International Co., Ltd. All rights reserved.
All other brand names and trademarks are the registered property of their respective owners.

Contents

EMC Information	ii
RoHS	ii
Safety	ii
SJ/T 11364-2006	ii
User Information	iii
Online Registration	iii
Telephone Support	iii
User Notice	iii
Package Contents	iv
VM1600	iv
VM7404	iv
VM7514 / VM8514	iv
VM7804 / VM8804	iv
VM7604 / VM8604	iv
VM7104	v
VE805R	v
Contents	vi
About this Manual	xi
Conventions	xii
Product Information	xii

Chapter 1.

Introduction

Overview	1
Features	4
VM1600	4
VM7404	5
VM7514 / VM8514	6
VM7804 / VM8804	6
VM7604 / VM8604	6
VM7104	7
VE805R	7
Requirements	9
Input / Output Board	9
Source Devices	9
Display Devices	9
Cables	9
Browsers	10
Optional Equipment	11
Components	12
VM1600 Front View	12
VM1600 Rear View	14
VM7404 Front View	16
Supported Standards	16

VM7514 Front View	17
VM8514 Front View	17
VM7804 Front View	18
VM8804 Front View	18
VM7604 Front View	19
VM8604 Front View	19
VM7104 Front View	20
VE805R Front View	21
VE805R Rear View	21

Chapter 2.

Hardware Setup

Rack Mounting	23
Mounting with Brackets	24
Grounding	25
Input / Output Board Installation	26
Cable Connection	28
Installation Diagram	29

Chapter 3.

Front Panel Operation

Overview	31
Front Panel Pushbuttons	31
Basic Navigation	31
Front Panel LCD	32
LCD Password	32
Port Switching	33
Video / Audio Pushbutton	33
Output Port Selection	36
Profile Pushbutton	38
LCD Menu	39
LCD Main Screen	40
IP Setting	41
Serial Port Setting	42
Serial Port Address Setting	42
Baud Rate	43
Serial Port Mode	43
Operation Mode	45
EDID	45
CEC	47
OSD	48
Output Status	49
Security Mode	51
Mode	51
Change Password	52
Save to a Profile	54
Play/Stop the Profile Schedule	55

Turn Video Wall Off 55

Chapter 4.

Browser Operation

Overview 57

Logging In 57

Main Page 58

 Menu Bar 58

Profile List 59

 Adding/Playing a Profile 59

 Importing/Exporting a Profile 61

 Profile List Options 62

 Profile 62

 Play Window 63

 Other 64

Profile Scheduling 65

Connection Profiles 67

 Digital Signage Profile 67

 Grid View 69

 Output Options 69

Video Wall Profile 70

 Video Wall Options 70

 Null Input 72

 Independent Output 72

 Grouping 73

 Group 73

 Display Preferences 74

 Video Wall Example 1 74

 Video Wall Example 2 75

Output Options 77

 HDMI Audio Control 77

 HDMI Video Options 79

System Settings 81

 General 83

 Serial Settings 83

 Fan Status 83

 Power Status 84

 Device Info 84

 Other 84

User Account 85

 Add Account 86

 Permission Level 87

Port Name 88

Network 89

EDID Settings 90

 EDID & CEA Description 92

Maintenance	100
VE805R Firmware Upgrade	100
IR/RS232 Channel	102
HDCP	104
OSD/CEC	105
Telnet Operation	106
Configuration Menu	106
1. H – Call up the command list for help	106
2. IP – Set IP address	107
3. LO – Load connections from profile	107
4. PW – Change password	107
5. RI – Read what input is connected to nn output	107
6. RO – Read what output is connected to nn input	107
7. SB – Set serial port baud rate	107
8. SS – Switch input to specified output	107
9. SV – Save the current connections into a profile	107
10. TI – Set timeout	108
11. VR – Software version information	108

Chapter 5.

RS-232 Commands

Serial Control Protocol Commands	109
RS232 Pin Assignment	109
Configuring the Serial Port	109
RS-422 / RS-485	110
Verification	110
Switch Port Command	111
Mute Command	114
Volume Command	116
Save/Load Profile Commands	118
EDID Mode Command	120
CEC Command	122
Read Command	123
DVI/HDMI Example:	123
Reset Command	125
Baud Rate Command	126
OSD Command	127
Echo Command	128
Scaling Command	129
Fan Speed Command	133
Alert Command	134

Appendix

Safety Instructions	135
General	135
Rack Mounting	137
Technical Support	138

International	138
North America	138
Specifications	139
VM1600	139
VM7404	140
VM7514 / VM8514	141
VM7804 / VM8804	142
VM7604 / VM8604	143
VM7104	144
VE805R	145
VM-PWR400	146
VM-FAN60	146
Limited Warranty	146

About this Manual

This User Manual is provided to help you get the most from your VM1600 system. It covers all aspects of installation, configuration and operation. An overview of the information found in the manual is provided below.

Chapter 1, Introduction, introduces you to the Modular Matrix Solution system and its components. Its purpose, features and benefits are presented, and its front and back panel components are described.

Chapter 2, Hardware Setup, describes how to set up the hardware for your Modular Matrix Solution installation.

Chapter 3, Front Panel Operation, explains the fundamental concepts involved in operating the VM1600 at the local site via the front panel LCD display using pushbuttons.

Chapter 4, Browser Operation, provides a complete description of the Modular Matrix Solution's web Graphical User Interface (GUI), and how to use it to remotely configure and operate the Modular Matrix Solution.

Chapter 5, RS-232 Commands, provides a complete list of the serial control protocol commands used when utilizing the RS-232 Serial Port so that an extra source device can be utilized in the installation.

An Appendix, provides specifications and other technical information regarding the Modular Matrix Solution.

Conventions

This manual uses the following conventions:

- `Monospaced` Indicates text that you should key in.
- [] Indicates keys you should press. For example, [Enter] means to press the **Enter** key. If keys need to be chorded, they appear together in the same bracket with a plus sign between them: [Ctrl+Alt].
 - 1. Numbered lists represent procedures with sequential steps.
 - ◆ Bullet lists provide information, but do not involve sequential steps.
 - Indicates selecting the option (on a menu or dialog box, for example), that comes next. For example, Start → Run means to open the *Start* menu, and then select *Run*.
 -  Indicates critical information.

Product Information

For information about all ATEN products and how they can help you connect without limits, visit ATEN on the Web or contact an ATEN Authorized Reseller. Visit ATEN on the Web for a list of locations and telephone numbers:

International	http://www.aten.com
North America	http://www.aten-usa.com

Chapter 1

Introduction

Overview

This ATEN Modular Matrix Solution Series is comprised of the VM1600 Modular Matrix Switch; and/or the VM7404 4-Port 3G-SDI Input/Output Board, VM7514 / VM8514 4-Port HDBaseT Input/Output Board, VM7804 / VM8804 4-Port HDMI Input / Output Board, VM7604 / VM8604 4-Port DVI Input / Output Board, VM7104 4-Port VGA Input Board and VE805R HDMI HDBaseT Lite Receiver with Scaler.

The VM1600 Modular Matrix Switch offers advanced access and real-time control of multiple local and remote A/V input devices and displays from a single chassis. Operators can work from 4 x 4 up to 16 x 16 inputs and outputs simultaneously, as well as incorporate multiple digital video formats within the setup. It uses TMDS technology to support high speed data transfer at 1080p / 1920 x 1200 @ 60Hz.

The VM7404 is a 4-Port 3G-SDI input board provides the capability to connect to SDI sources, such as 3G-SDI, HD-SDI and SD-SDI, and supports high quality video resolutions up to 1080p @ 60Hz. The VM7404 also supports separate analog stereo audio signals for independent routing.

The VM7514 / VM8514 4-Port HDBaseT Input/Output Boards offers an easy way to route any of 4 HDBaseT audio/video sources to any of 4 HDBaseT display devices, in combination with the ATEN Modular Matrix Switch. When the VM8514 HDBaseT Output Board is used in conjunction with the VE805R HDBaseT Extender it features Seamless Switch technology and video wall functionality.

The VM7804 / VM8804 4-Port HDMI Input / Output Board is a hot-swappable I/O board that offers an easy way to route any of 4 audio/video sources to any of 4 displays and installs in the Modular Matrix Switch. The VM8804 supports Seamless Switch technology that provides video switching in real-time, a built in scaler that handles different video resolutions, and EDID Expert technology for fast smooth switching between displays. The VM7804 / VM8804 also supports separate stereo audio signals that can be routed independently and extracted from embedded HDMI audio signals.

The VM7604 / VM8604 4-Port DVI Input / Output Board is a hot-swappable I/O board that offers an easy way to route any of 4 audio/video sources to any of 4 displays and installs in the Modular Matrix Switch. The VM8604 supports

Seamless Switch technology that provides video switching in real-time, a built in scaler that handles different video resolutions and EDID Expert technology for fast smooth switching between displays.

The VM7104 4-Port VGA Input Board offers an easy way to route 4 VGA video and audio sources to 4 displays and speakers. In addition, the VM7104 can be mixed with any modular output boards on the VM1600 for optimum flexibility.

The VE805R HDMI HDBaseT Lite Receiver with Scaler can be combined with an ATEN HDMI HDBaseT transmitter or splitter to extend your HDMI display up to 70 m from the source using a single Cat 6a cable (or up to 60 m when using a single Cat 5e cable). With a built-in scaler, the VE805R supports the scaling of different video resolutions. When combined with ATEN HDBaseT output boards, it supports video wall functionality. In addition, the VE805R is equipped with RS232 and IR signaling pass-through which allows RS232 and IR channel control from the remote to local unit, to control the HDMI source, or from the local to remote unit, to control the display device. The VE805R is HDCP compliant.

Combining these devices, this solution can be conveniently customized, allowing users to independently switch and route video and/or audio signals to various monitors, displays, projectors and/or speakers simply by pressing front panel pushbuttons. The VM1600's built-in Scaler encodes video formats in order to provide seamless, real-time switching while ensuring stable signal transmission. In addition, the front panel LCD shows a quick view of active port connections, and includes an option to select an EDID Mode that yields the best resolution across different monitors.

The VM1600 is easily expandable and accommodates ATEN's hot-swappable I/O boards. Equipped with automatic signal conversion, it allows a combination of digital video formats, thus making it ideal for large-scale A/V applications.

Setup is fast and easy; install the modular I/O boards by sliding them into the VM1600's rear panel slots, then plug the device cables into the appropriate ports on the I/O boards and your ready.

This solution can be connected to the network through the VM1600's LAN port, allowing the installation to take advantage of internal Cat 5 Ethernet wiring built into most modern commercial buildings. Once initial network setup has been accomplished at the local level, the VM1600 can be conveniently managed remotely using any web browser. Furthermore, for complete systems integration, the VM1600's built-in RS-232 and RS-485/RS-

422 ports allows the switch to be configured through a high-end controller or PC.

The ATEN Modular Matrix Solution Series is a powerful integrated A/V setup targeted towards broadcasting stations, traffic and transportation-related control rooms, emergency service centers and any application that requires customizable high speed A/V signal routing.

Features

VM1600

- ◆ Connects any of 16 video sources to any of 16 displays in combination with ATEN Modular Matrix Solutions
- ◆ Superior video quality – HDTV resolution of 480p, 720p and 1080p (1920 x 1080), VGA, SVGA, SXGA, UXGA and WUXGA (1920 x 1200)
- ◆ HDMI (3D, Deep Color) (VM7804 / VM8804)
- ◆ HDCP 1.4 compliant (VM8604 / VM7604 / VM7804 / VM8804)
- ◆ Seamless Switch provides continuous video streams, real-time switching and stable signal transmission*
- ◆ EDID Expert™ Technology – selects optimum EDID settings for smooth power-up and highest quality display
- ◆ Easily switch between multiple sources and multiple displays
- ◆ Full digital signal routing – supports TMDS high data transfer rate at 1080p / 1920 x 1200 @ 60Hz
- ◆ Control via front panel pushbuttons, RS-232 / RS-485 / RS-422 serial ports and Ethernet connection
- ◆ Easy configuration via web browser Graphical User Interface (GUI), plus Telnet
- ◆ Built-in bi-directional RS-232 serial remote port for high-end system control
- ◆ Hot-pluggable:
 - ◆ Modular Fan
 - ◆ Power Module
 - ◆ Easy integration I/O Boards
- ◆ Optional redundant power supply for continuous operations
- ◆ Built-in Scaler in CrossPoint design that unifies different video formats and provide continuous video streams, real-time switching and stable signal transmission
- ◆ Supports Consumer Electronics Control (CEC) (VM7804 / VM8804)
- ◆ Supports Transition Effect – implements FPGA matrix system architecture to easily switch between multiple sources and multiple displays
- ◆ HDMI audio can be extracted and stereo audio can be embedded (VM7804 / VM8804)

- ◆ Firmware upgradeable via web
- ◆ Rack Mountable

VM7404

- ◆ Four 3G-SDI inputs - allows you to easily switch between four media sources (such as professional cameras) with automatic detection of signal type (e.g. 3G-SDI, HD-SDI and SD-SDI)
- ◆ Analog stereo inputs - The four analog balanced/unbalanced stereo audio inputs separate audio routing within the system.
 - ◆ The analog stereo audio input can be integrated into HDMI TMDS signals (the TMDS audio signals will be replaced), and the SDI audio signals can be extracted and sent to the stereo audio output ports
- ◆ Supported SDI formats:
 - ◆ SD-SDI (SMPTE 259M, up to 270Mbps)
 - ◆ HD-SDI (SMPTE 292M, 296M, up to 1.485Gbps)
 - ◆ 3G-SDI (SMPTE 424M, 425M level A/B-DL, up to 2.97Gbps)
- ◆ Extensive input cable equalization distance:
 - ◆ 3G-SDI in 100m
 - ◆ HD-SDI in 150m
 - ◆ SD-SDI in 300m
- ◆ Supports high-resolution video
 - ◆ SD Format Support
 - ◆ PAL/50 PAL and NTSC/59.94
 - ◆ HD Format Support
 - ◆ 1080p: 23.98, 24, 25, 29.97, 30, 50, 59.94, 60
 - ◆ 1080PsF: 25, 29.97, 30
 - ◆ 1080i: 50, 59.94, 60
 - ◆ 720p: 50, 59.94, 60
- ◆ Embedded HDMI stereo audio - can be switched and embedded
- ◆ Supports Seamless Switching™
- ◆ Supports output port scaling - built-in Scaler on each output port enables scaling to different video resolutions
- ◆ Adjustable Stereo audio output volume - analog audio levels of the selected output can be adjusted and muted

- ◆ ATEN EDID Expert support - allows management of EDID data to ensure all connected sources can output content to displays reliably

VM7514 / VM8514

- ◆ Compatible with the VM1600 and can be mixed with modular I/O boards of any type for optimum flexibility
- ◆ Bi-directional RS-232 serial port for control and configuration
- ◆ HDBaseT Connectivity – extends 4 HDBaseT connections up to 100 meters via single Cat 5e/6 cable
- ◆ HDBaseT Anti-jamming – resists signal interference during video transmission using
- ◆ HDBaseT technology
- ◆ Connected to VE805R:
 - ◆ Seamless Switch™ – features close-to-zero-second switching, continuous video streams, real-time switching and stable signal transmissions
 - ◆ Video Wall – features configurable video wall profiles for custom layouts via point-n-click web GUI
- ◆ Bi-directional IR channel for IR signal control; IR transmission is processed one way at a time
- ◆ Supports full frequency IR signal from 30KHz to 60KHz

VM7804 / VM8804

- ◆ 4 HDMI input ports (VM7804); 4 HDMI output ports (VM8804)
- ◆ Superior video quality – HDTV resolutions of 480p, 720p and 1080p (1920 x 1080); VGA, SVGA, XGA, SXGA and WUXGA (1920 x 1200)
- ◆ HDMI (3D, Deep Color); HDCP 1.4 Compatible
- ◆ Consumer Electronics Control (CEC) support
- ◆ Built-in scaler on each output port to support the scaling function for different video Resolutions (VM8804)
- ◆ Audio-enabled, HDMI audio can be extracted and stereo audio can be embedded
- ◆ Hot-swappable design

VM7604 / VM8604

- ◆ 4 DVI-D input ports (VM7604); 4 DVI-D output ports (VM8604)

- ◆ Superior video quality – HDTV resolutions of 480p, 720p and 1080p (1920 x 1080); VGA, SVGA, XGA, SXGA and WUXGA (1920 x 1200)
- ◆ HDCP 1.4 Compatible
- ◆ Built-in scaler on each output port to support the scaling function for different video resolutions (VM8604)
- ◆ Hot-swappable design
- ◆ Audio-enabled

VM7104

- ◆ Connects 4 VGA inputs
- ◆ Superior video quality – up to 1920 x 1200 @ 60Hz
- ◆ Supports RGBHV / RGBS / YCbCr / YPbPr input signals
- ◆ Hot-swappable design

Note: When the VM7104 is used with the VM8514+VE805R, VM8804 or VM8604, the Seamless Switch, scaler and video wall functions can be activated.

VE805R

- ◆ HDBaseT Connectivity – extends the connection between the VM8514 HDBaseT outputs and an HDMI display over a long distance via single Cat 5e/6 cable
- ◆ HDBaseT Anti-jamming – resists signal interference during high quality video transmissions using HDBaseT technology
- ◆ Bi-directional RS-232 serial port for control and configuration
- ◆ Scaler – features a scaling function to integrate a video wall seamlessly with various output formats*
- ◆ Seamless Switch™ – close-to-zero second switching that provides continuous video streams, real-time switching and stable signal transmissions*
- ◆ Video Wall – features configurable video wall profiles available for custom screen layouts via simple point-n-click web GUI*
- ◆ Supports full frequency IR signals from 30KHz to 60KHz
- ◆ Rack-mountable

Note: If Seamless Switch is enabled, the video output will not display 3D, Deep Color or interlace (i.e., 1080i) resolutions. To use these features, you must disable Seamless Switch.

Requirements

The following are required for a complete VM1600 Modular Matrix Solution Series installation:

Input / Output Board

- ◆ VM7404 (3G-SDI input board)
- ◆ VM7514 (HDBaseT input board) and VM8514 (HDBaseT output board)
- ◆ VM7804 (HDMI input board) and VM8804 (HDMI output board)
- ◆ VM7604 (DVI input board) and VM8604 (DVI output board)
- ◆ VM7104 VGA input board

Source Devices

- ◆ For VM7404 4-Port 3G-SDI Input Board: SDI sources, including 3G-SDI, HD-SDI and SD-SDI
- ◆ For VM7514 4-port HDBaseT input board + VE802T HDBaseT Transmitter: Digital A/V source device with HDMI output connector(s)
- ◆ For VM7804 4-port HDMI input board: Digital A/V source device with HDMI output connector(s)
- ◆ For VM7604 4-Port DVI input board: Digital A/V source device with DVI output connector(s)
- ◆ For VM7104 4-Port VGA input board: A/V source device with VGA output connector(s)

Display Devices

- ◆ For VM8514 4-port HDBaseT output board + VE805R HDBaseT Receiver: Digital Display device(s) with HDMI input connector(s)
- ◆ For VM8804 4-port HDMI output board: Digital Display device(s) with HDMI input connector(s)
- ◆ For VM8604 4-Port DVI output board: Digital Display device(s) with DVI input connector(s)

Cables

- ◆ 1 SDI cable for each source device (VM7404)
- ◆ 1 Cat 5e cable for each transmitter (VM7514)
- ◆ 1 Cat 5e cable for each receiver (VM8514)

- ◆ 1 HDMI cable for each source device (VM7804)
- ◆ 1 HDMI cable for each display device (VM8804)
- ◆ 1 DVI cable for each source device (VM7604)
- ◆ 1 DVI cable for each display device (VM8604)
- ◆ 1 VGA cable for each source device (VM7104)
- ◆ 1 HDMI cable for each display device (VE805R)
- ◆ 1 audio cable for each audio source device (VM7804 / VM7604)
- ◆ 1 audio cable for each audio device / speaker (VM8804 / VM8604)
- ◆ 1 Ethernet cable (VM1600)
- ◆ 1 RS-232 serial cable (VM1600 / VM7514 / VM8514 / VE805R)
- ◆ 1 RS-485/RS-422 serial cable (VM1600)
- ◆ 1 IR cable for each IR transmitter device (VM7514 or VM8514)
- ◆ 1 IR cable for each IR receiver device (VM7514 or VM8514)

Note: No cables are included in this package. We strongly recommend that you purchase high-quality cables of appropriate length since this will affect the quality of the audio and video display. Contact your dealer to purchase the correct cable sets.

Browsers

Supported web browsers are shown in the table below:

OS	Java Version	Browser	Version
Windows 8.1	V1.8.0_60	Chrome	45.0.2454.85 m
		Firefox	40.0.3
		Safari	5.1.7
		Opera	31.0.1889.174
		IE11	11
Windows 2012 R2 (64bit)	V1.8.0_60 (64bit)	IE11	11 (64bit)
Windows 2008 R2 (64bit)	V1.8.0_60 (64bit)	IE8	8
Windows 7 SP1(64bit)	V1.8.0_60 (64bit)	IE10	10 (64bit)
Windows XP	V1.8.0_60	IE8	8

OS	Java Version	Browser	Version
CentOS 7.0 (64Bit)	V1.8.0_60 (64bit)	Firefox	40.0.3
Ubuntu 12.04	V1.8.0_60	Chrome	45.0.2454.85
Solaris 11(64bit)	V1.8.0_25	Firefox	33
Mac 10.10	V1.8.0_25	Safari	8

Optional Equipment

Depending on any optional equipment that you may have purchased, one of the following may be included in your package. Contact your ATEN dealer to purchase any of these additional accessories.

Model No.	Description	Dimensions (L x W x H)	Weight
2X-026G	Easy Installation Rack Mount Kit - Short	42-70 cm (depth)	-
2X-027G	Easy Installation Rack Mount Kit - Long	68-105 cm (depth)	-
2X-030G (Left)	Video Wall TV Mounting Brackets	15.47 x 11.83 x 43.00 cm	2.00 kg
2X-030G (Right)	Video Wall TV Mounting Brackets	15.47 x 12.80 x 43.00 cm	2.00 kg
2X-RC1600	Video Wall TV Stand	140.00 x 90.00 x 207.00 cm	60.00 kg
VM-PWR400	Video Matrix Power Module	-	-
VM-FAN60	Video Matrix Fan Module	-	-

Components

VM1600 Front View

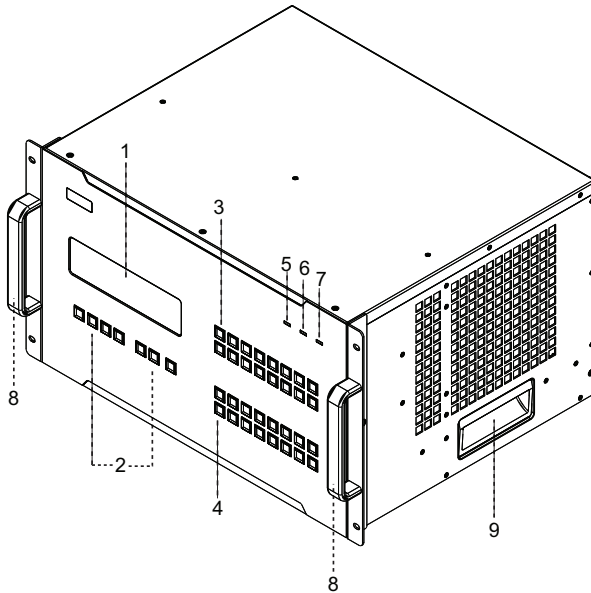

No.	Component	Description
1	LCD Display	The LCD Display shows the options for configuring and operating the VM1600. See <i>Front Panel Pushbuttons</i> , page 31, for details.
2	Function Pushbuttons	Use the UP, DOWN and CANCEL buttons to navigate the LCD display to configure the installation. Press the Video, Audio, Menu and Profile buttons to use each function. See <i>Front Panel Pushbuttons</i> , page 31, for details. Note: The pushbuttons have LEDs that light to indicate they have been selected.
3	Input Pushbuttons (1-16)	These pushbuttons refer to the Input ports on the VM1600 rear panel. Press to select the Input port. These pushbuttons may also correspond to menu options, profiles and other selections.
4	Output Pushbuttons (1-16)	These pushbuttons refer to the Output ports on the VM1600 rear panel. Press to select the Output port.
5	Alarm LED	The Alarm LED lights red to indicate the power or fan module has failed.

No.	Component	Description
6	Redundant Power LED	This LED lights green to indicate the redundant power module is plugged in and working.
7	Primary Power LED	This LED lights green to indicate the primary power module is plugged in and working.
8	Handles	The two front handles are used to install the unit into a rack.
9	Recessed Handles	The two side handles are used to transport the unit.

VM1600 Rear View

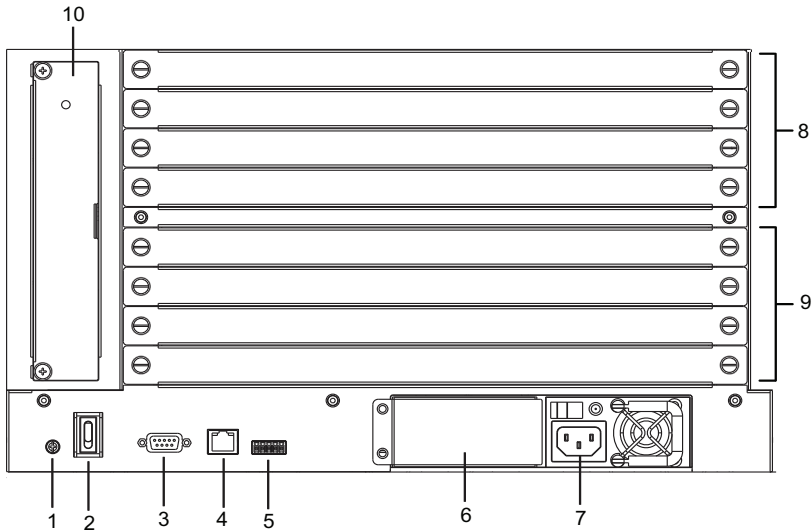

No.	Component	Description
1	Grounding Terminal	The grounding wire attaches here. See <i>Grounding</i> , page 25, for further details.
2	Power Switch	This is a standard rocker switch that powers the unit on and off.
3	RS-232 Serial Port	Connect a computer or high-end system controller via this serial port.
4	Ethernet Port	In order to access the VM1600's web Graphical User Interface (GUI), the VM1600 must be connected to the network. The cable that connects the VM1600 to your LAN plugs in here. See <i>Cable Connection</i> , page 28, for further details
5	RS-485 / RS-422 Serial Port	Connect a computer or high-end system controller via this serial port.
6	Redundant Power Slot (Optional)	This slot with protective cover is used to install an additional power supply for redundant power protection. Note: The extra power module is not included in the VM1600 package. See <i>Depending on any optional equipment that you may have purchased, one of the following may be included in your package. Contact your ATEN dealer to purchase any of these additional accessories.</i> , page 11, for details.

No.	Component	Description
7	Primary Power Supply	This is a standard 3-pin power socket. The power cord from a source plugs in here.
8	Input Board Slots	Unscrew the cover to insert the Input boards into these 4 horizontal slots. The source devices connect to the inserted Input boards.
9	Output Board slots	Unscrew the cover to insert the output boards into these 4 horizontal slots. The display devices connect to the inserted Output boards.
10	Fan Module	This slot contains the fan module. The fan is hot-pluggable and the panel unscrews to install a replacement module. See <i>Depending on any optional equipment that you may have purchased, one of the following may be included in your package. Contact your ATEN dealer to purchase any of these additional accessories.</i> , page 11, for details

VM7404 Front View

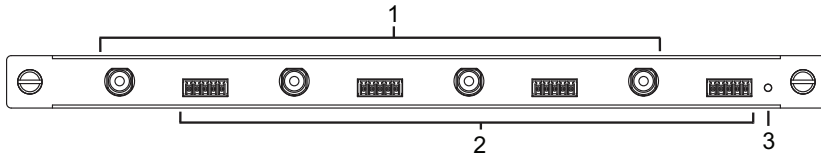

No.	Component	Description
1	SDI Input Ports	Connect the cables from your video source devices to these ports.
2	Analog Stereo Audio Input Ports	Connect the cables from your audio source devices to these ports.
3	Status LED	The VM7404 has an LED to indicate the working status.

Supported Standards

1. 3G-SDI
 - ◆ SMPTE 424M
 - ◆ 425M level A/B-DL
 - ◆ Up to 2.97 Gbps
2. Sampling structure and pixel depth
 - ◆ 4:2:2 10/12-bit
 - ◆ 4:4:4 10/12-bit
3. Format
 - ◆ PAL /50 PAL and NTSC/59.94
 - ◆ 720p 25, 29.97, 30, 50, 59.94, 60
 - ◆ 1080i 50, 59.94, 60
 - ◆ 1080PsF 25, 29.97, 30
 - ◆ 1080p 23.98, 24, 25, 29.97, 30, 50, 59.94, 60

VM7514 Front View

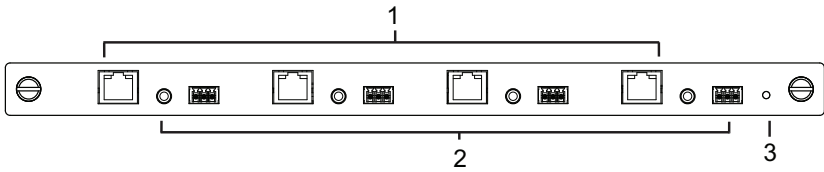

No.	Component	Description
1	HDBaseT Input Ports	Connect the Cat 5e cables from your HDBaseT transmitter to these ports.
2	IR / RS-232 Input Ports	Connect the cables from your IR transmitter to the mini stereo jack ports, and connect the cables from your RS-232 device to the RS-232 ports.
3	Status LED	The VM7514 has an LED to indicate the working status.

VM8514 Front View

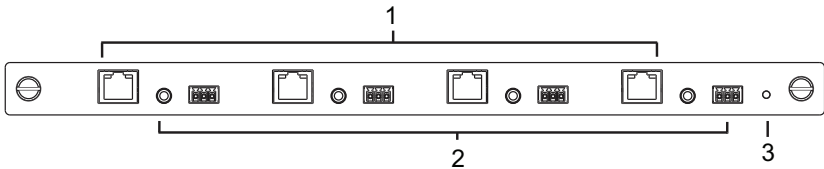

No.	Component	Description
1	HDBaseT Output Ports	Connect the Cat 5e cables from your HDBaseT receiver to these ports.
2	IR / RS-232 Output Ports	Connect the cables from your IR receiver to the mini stereo jack ports, and connect the cables from your RS-232 device to the RS-232 ports.
3	Status LED	The VM8514 has an LED to indicate the working status.

VM7804 Front View

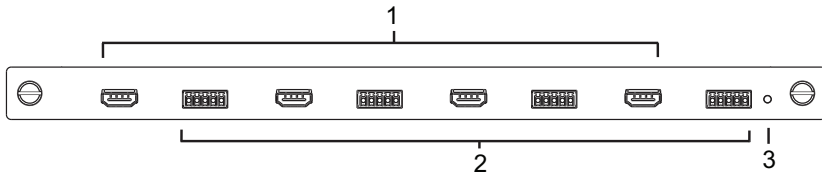

No.	Component	Description
1	HDMI Input Ports	Connect the cables from your HDMI video source devices to these ports.
2	Audio Input Ports	Connect the cables from your audio source devices to these ports.
3	Status LED	The VM7804 has an LED to indicate the working status.

VM8804 Front View

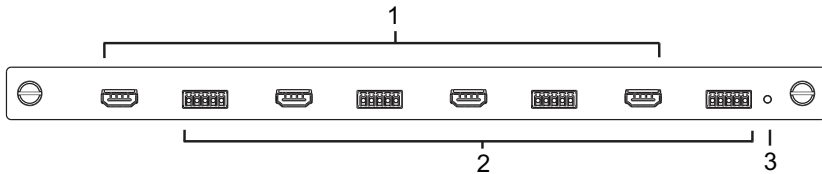

No.	Component	Description
1	HDMI Output Ports	Connect the cables from your HDMI display devices (monitors, projectors, TVs) to these ports.
2	Audio Output Ports	Connect the cables from your output audio devices or speakers to these ports.
3	Status LED	The VM8804 has an LED to indicate the working status.

VM7604 Front View

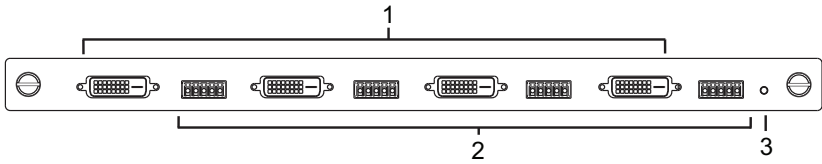

No.	Component	Description
1	DVI Input Ports	Connect the cables from your video source devices to these ports.
2	Audio Input Ports	Connect the cables from your audio source devices to these ports.
3	Status LED	The VM7604 has an LED to indicate the working status.

VM8604 Front View

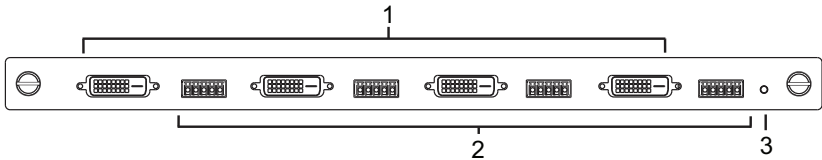

No.	Component	Description
1	DVI Output Ports	Connect the cables from display devices (monitors, projectors, TVs) to these ports.
2	Audio Output Ports	Connect the cables from your output audio devices or speakers to these ports.
3	Status LED	The VM8604 has an LED to indicate the working status.

VM7104 Front View

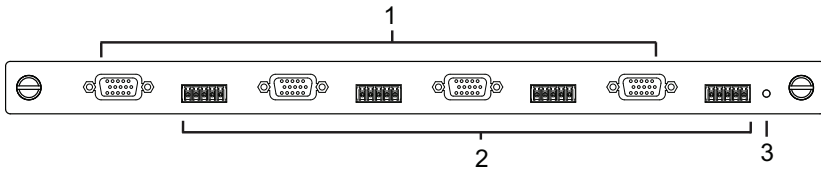

No.	Component	Description
1	VGA Input Ports	Connect the cables from your VGA video source devices to these ports.
2	Audio Input Ports	Connect the cables from your audio source devices to these ports.
3	Status LED	The VM7104 has an LED to indicate the working status.

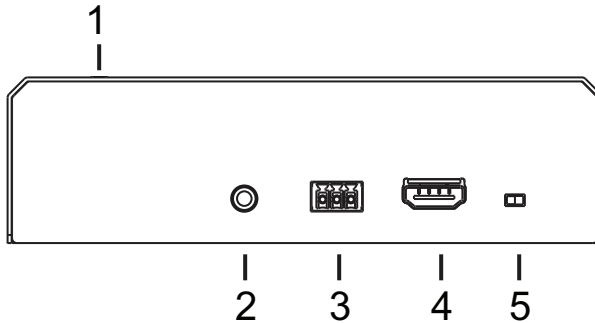
VE805R Front View**VE805R Rear View**

No.	Component	Description
1	LEDs	<p>Three LEDs – Power, Link and HDMI Out – light when the unit is properly connected to an appropriate source.</p> <ul style="list-style-type: none"> ◆ Power - lights Green to indicate the unit is receiving power. ◆ Link - lights Orange to indicate that communication between VE805R and output board is established. ◆ HDMI Out - lights Orange to indicate the HDMI output signal is good. LED blinks Orange every second to indicate that the device is in F/W upgrade mode.
2	IRPort	Connect the IR transmitter or receiver cable port into this mini stereo jack port.
3	RS-232 Port	Use the captive screw connectors (3 pole) to connect the cable from your serial device into the RS-232 port.
4	HDMI Output Port	Connect the cable from your HDMI display device (monitors, projectors, TVs) into this port.

No.	Component	Description
5	Firmware Upgrade Switch	Set this switch to OFF (left) for normal operation. Set this switch to ON (right) and reset the unit's power to enter firmware upgrade mode (see page 100 for details).
6	HDBaseT Input	Use a Cat 5e cable to connect the VE805R to the VM8514 output board.
7	Power Jack	The power adapter cable plugs connects here.

Chapter 2

Hardware Setup



1. Important safety information regarding the placement of this device is provided on page 135. Please review it before proceeding.
2. Make sure that the power to all devices connected to the installation are turned off. You must unplug the power cords of any computers that have the Keyboard Power On function.

Rack Mounting

The Modular Matrix Switch can be mounted in a 19" (1U) system rack. For the most convenient front panel operation at the local site, mount the unit at the front of the rack, as follows:

1. Position the unit in the front of the rack, and align the holes of the unit's built-in mounting brackets with the holes in the rack.
2. Use screws to attach the unit to the rack.

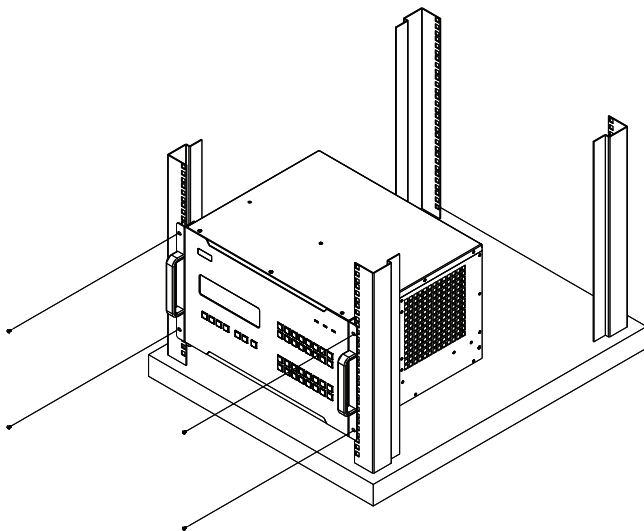

Mounting with Brackets

You can also use mounting brackets to install the VM1600, as shown below.

Note: The Mounting Kit is not included with the package. To purchase a mounting kit please contact your dealer.

1. Screw the mounting brackets (Easy Installation Rack Mount Kit, see page 11) to the rack, as shown in the diagram.

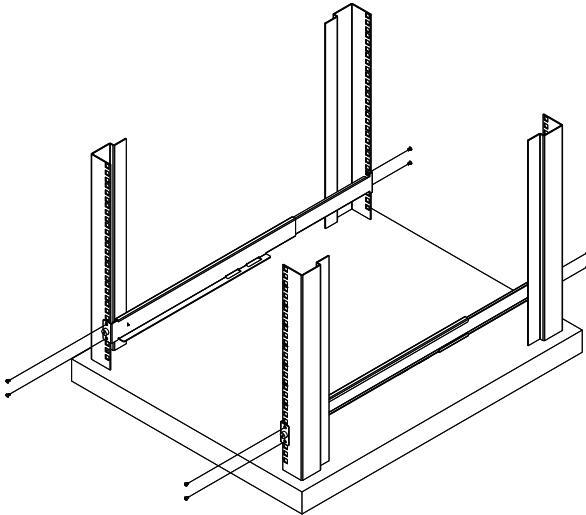

2. Slide the unit along the brackets, then screw the front panel to the rack.

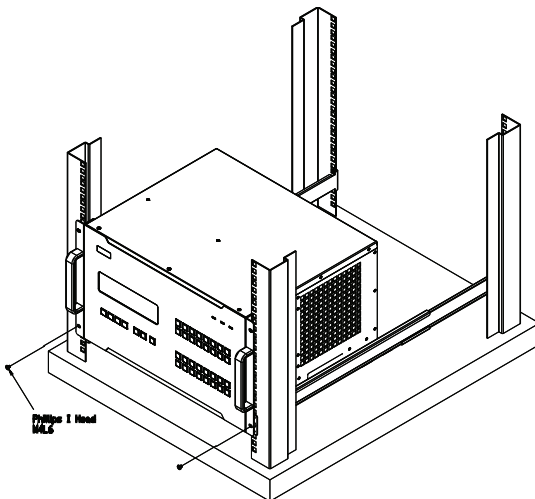

Grounding

To prevent damage to your installation, it is important that all devices are properly grounded.

1. Use a grounding wire to ground the installation using the VM1600's rear panel, by connecting one end of the wire to the grounding terminal, and the other end of the wire to a suitable grounded object.

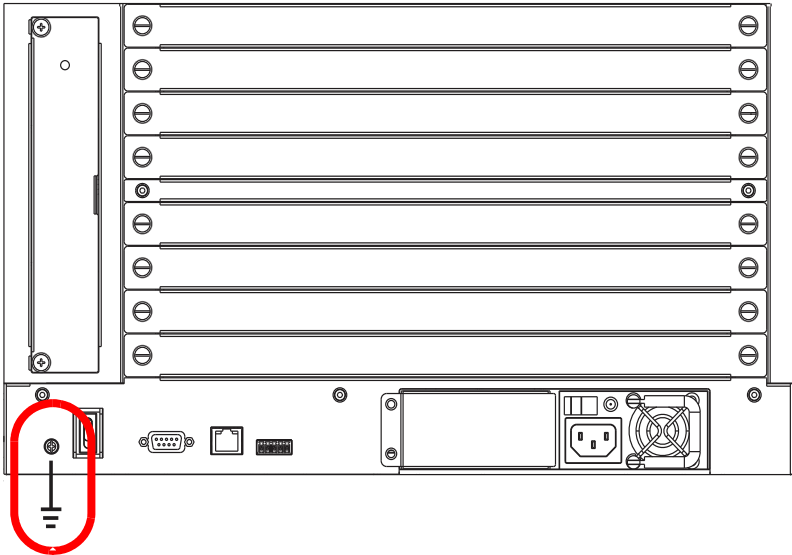

2. Make sure that all devices in your installation are properly grounded.

Note: The grounding wire is not included in the package. Please contact your dealer for details of purchase.

Input / Output Board Installation

To install the I/O boards in the VM1600, do the following:

Note: The four top slots on the Modular Matrix Switch are for the Input boards. The four bottom slots on the Modular Matrix Switch are for the Output boards.

1. On the rear of the VM1600, unscrew the two screws from a top and bottom slot, and remove the covers.

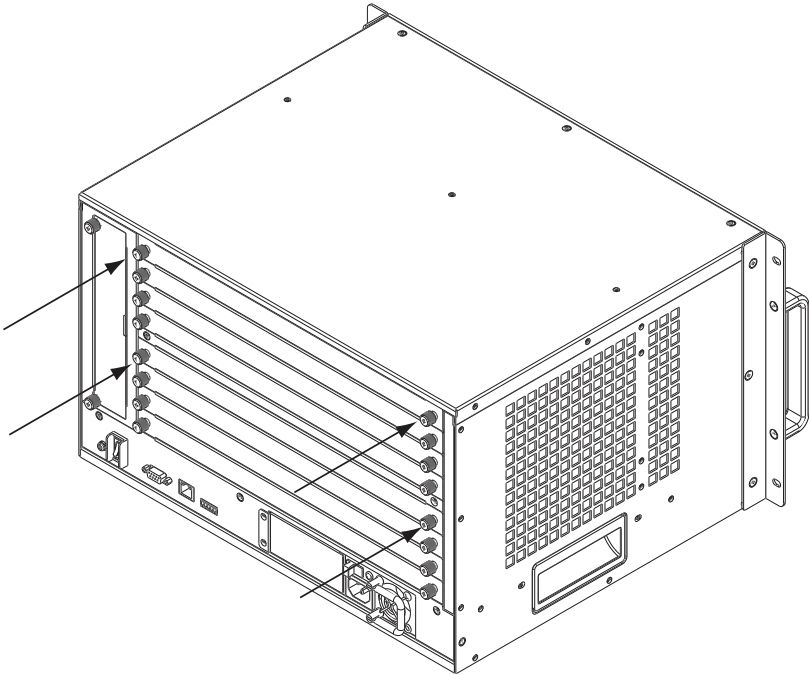

(Continues on next page.)

2. Slide an input board into a top slot and tighten the screws to secure the board to the VM1600.

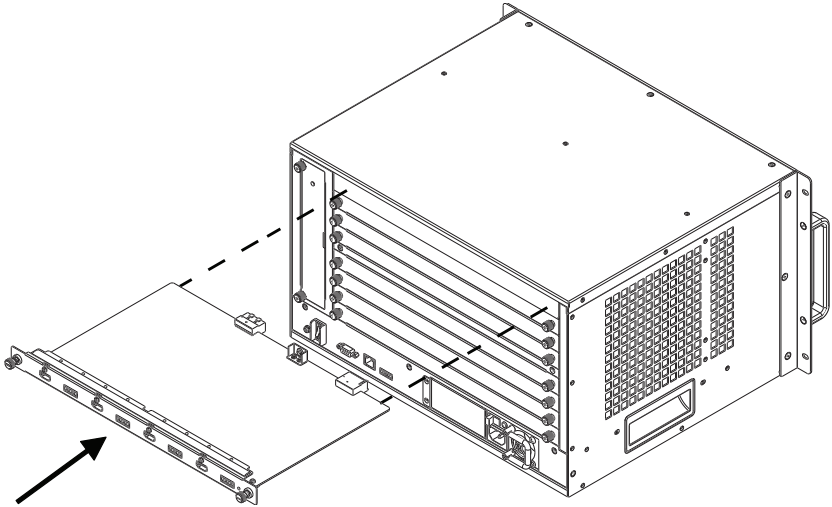

3. Slide an output board into a bottom slot and tighten the screws to secure the board to the VM1600.

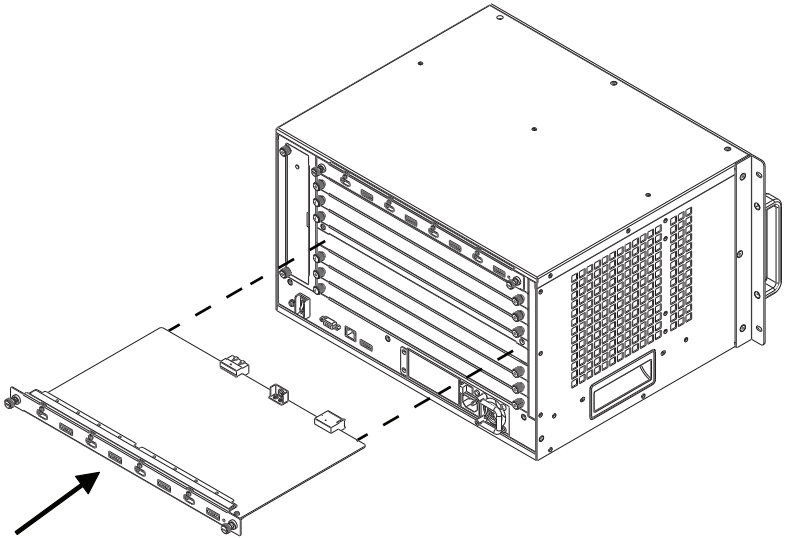

4. Repeat steps 2 and 3 to install additional I/O boards.
5. Power on the VM1600.

Cable Connection

Installation of the VM1600 is simply a matter of connecting the appropriate cables. Refer to the installation diagram on the following page (the numbers in the diagram correspond to the steps below), and do the following:

1. Use a grounding wire to ground the unit by connecting one end of the wire to the grounding terminal, and the other end of the wire to a suitable grounded object.

Note: Do not omit this step. Proper grounding helps to prevent damage to the unit from surges or static electricity.

2. Unscrew the covers on the VM1600 rear panel and insert the I/O boards into the horizontal slots (See *Input / Output Board Installation*, page 26, for details).
3. Connect your A/V source device(s) to the **Video and Audio port(s)** of the Input Board on the VM1600.
4. Connect your video display device(s) to the **Video port(s)** of the Output Board on the VM1600.
5. Connect your speakers / audio output device(s) to the **Audio port(s)** of the Output Board on the VM1600.
6. (Optional) If using the remote operation features (web GUI), plug a Cat 5e cable from the network into the VM1600's **Ethernet** port.
7. (Optional) If you are using a serial control function, use an appropriate serial cable to connect the computer or serial controller to the VM1600's female **RS-232** serial port.
8. (Optional) If you are using the serial control function to control multiple VM1600's, use an appropriate serial cable to connect the computer or serial controller to the VM1600's female **RS-485 / RS-422** captive screw connector. The VM1600 package includes a terminal block connector that can be used for this connection.
9. Plug the power cord supplied with the package into the VM1600's 3-prong socket, and then into a power source.
10. (Optional) Plug in an additional power module for redundancy if required.

Note: Secondary power modules are not included in the VM1600 package. See *Depending on any optional equipment that you may have purchased, one of the following may be included in your package.*

Contact your ATEN dealer to purchase any of these additional accessories., page 11, for details.

11. Power on the VM1600 and all devices in the installation.

Installation Diagram

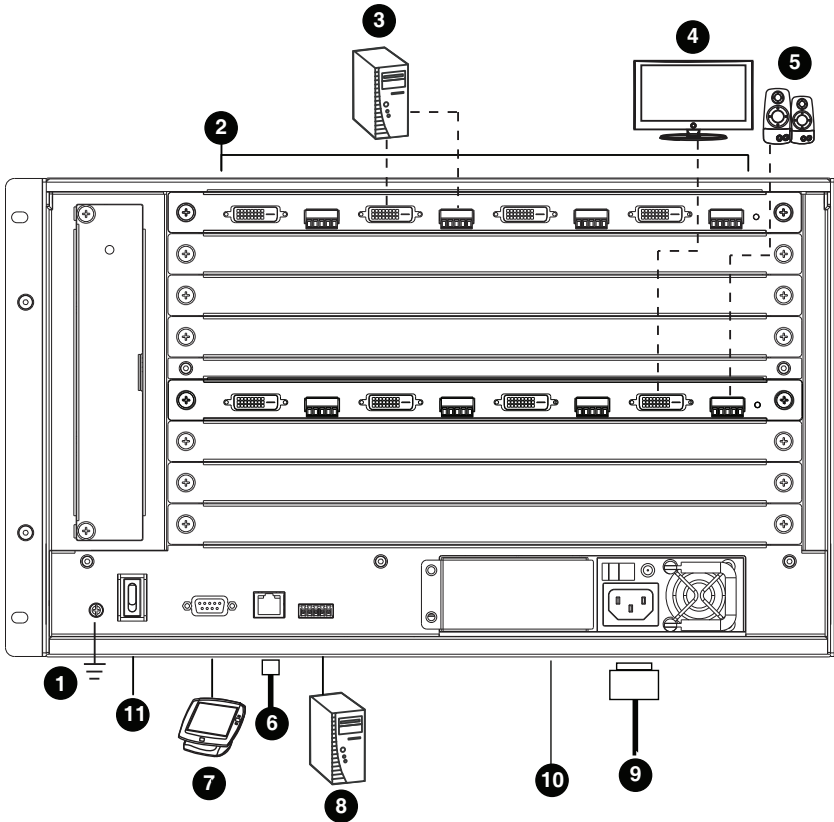

This Page Intentionally Left Blank

Chapter 3

Front Panel Operation

Overview



The Modular Matrix Switch installation can be configured and operated locally via the VM1600 front panel LCD and pushbuttons.

Front Panel Pushbuttons

The VM1600 front panel has easy-to-use pushbuttons for selecting which video/audio source shows on which display.

Basic Navigation

The VM1600's front panel LCD display operation is easy and convenient. Please note the following front panel button operations:

- ◆ Press the **VIDEO** pushbutton to configure the video connections.
- ◆ Press the **AUDIO** pushbutton to configure the audio connections.
- ◆ Use the **MENU** pushbutton to access the Menu page options: IP Setting, Serial Port Setting, Operation Mode, Security Mode, and Save to a Profile.
- ◆ Use the **PROFILE** pushbutton to select a profile or switch between the connection profiles which have been added to the Profile List (see page 59). Pressing this pushbutton for longer than 3 seconds displays the Save to a Profile page (see page 54).
- ◆ Use the **CANCEL** () pushbutton to go back a level, return to the Main screen, stop or exit an operation.
- ◆ Use the **UP** () and **DOWN** () pushbuttons to go to the next or previous options.
- ◆ Use the Input / Output (**1–16**) pushbuttons to select the Input/Output port. The pushbuttons may also correspond to menu options, profiles, and so on.

Front Panel LCD

The VM1600 features an LCD display for convenient configuration. This allows you to perform operations such as viewing the IP settings, configuring the serial port, setting EDID/CEC/OSD/Output Status, selecting security settings, and loading/saving connection profiles.

LCD Password

If the VM1600 has been configured to require a password for local operation (see *Security Mode*, page 51), the password screen appears when the VM1600 is powered on, and the cursor flashes on the first digit. Enter a 4-digit password to continue to the Main Screen.

Note: If you are accessing the VM1600 for the first time, the default password is 1234.

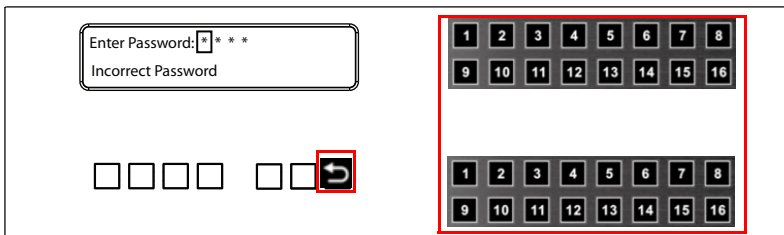

To enter a password, do the following:

1. Check that the cursor is flashing on the first digit.
2. Use the front panel number pushbuttons (1-9) to enter a 4-digit password. After the fourth digit, the cursor goes back to the first digit.
3. Press **Cancel** to clear the password. The digits revert to 4 asterisks (*) and the cursor returns to the first digit.

-
- Note:**
1. The VM1600 password can be any four digit combination between 1111 to 9999.
 2. If you enter an incorrect password, the cursor goes back to the first digit and reverts to flashing. The Incorrect Password message displays at the bottom of the screen, but clears as soon as a new digit is entered.
 3. If Password (see *Security Mode*, page 51) is Enabled, the LCD display time-out is 5 minutes by default.
-

Port Switching

From the Main Screen, you can configure the Input-to-Output port connections to associate an Input source device to an Output display.

Video / Audio Pushbutton

Before switching port connections, use the **Video** or **Audio** pushbuttons to select whether to switch only the video or the audio signal exclusively. Otherwise, both video and audio channels are configured together (default).

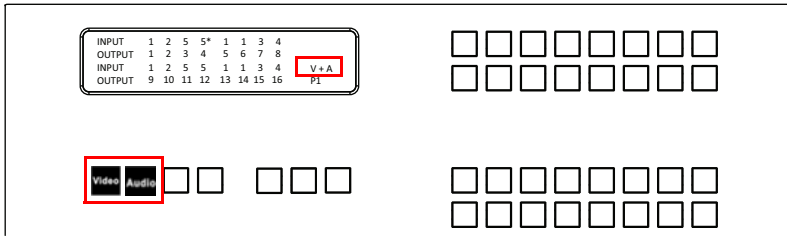

- ◆ Press the **Video*** pushbutton to configure Video connections. The built-in LED lights up and the LCD displays **Video** on the lower right side. Press the button again to cancel.
- ◆ Press the **Audio*** pushbutton to configure Audio connections. The built-in LED lights up and the LCD displays **Audio** on the lower right side. Press the button again to cancel.
- ◆ If both **Video** and **Audio** built-in LEDs are turned off, the video and audio channels are configured together and the LCD displays **V + A**.

Note: Press the **Video** or **Audio** pushbutton to independently switch either signal to a different source.

Input Port Selection

Use the Input Port pushbuttons to select the Input port you want to configure.

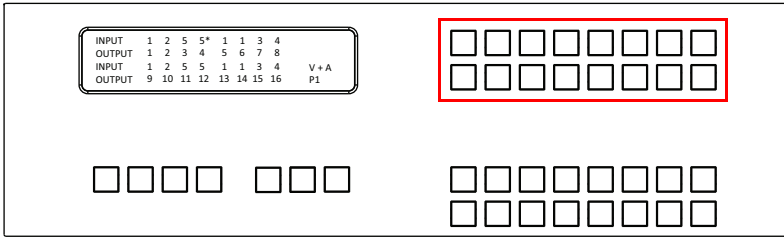

To select which input source displays on each output port, do the following:

1. Press any Input port pushbutton. The Output port LED(s) tied to the said Input port will begin to flash. Available Output port LED(s) will light up (steady).

In the example below, pressing Input port **1** shows it is tied to Output ports **1** and **2**.



(Continues on next page.)

(Continued from previous page.)

- To disconnect an Output port from an Input port, press the corresponding Output port pushbutton.

In the example below, Output port **2** has been disconnected from Input port **1**.

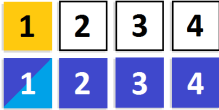

- To switch to another Input port, press any Input port pushbutton. The Output port LED(s) tied to the said Input port will flash.

In the example below, pressing Input port **2** shows it is tied to Output ports **3** and **4**.



- To connect Output port **2** to Input port **2** in the example above, press the Output port **2** pushbutton. The Output port **2** LED will also begin to flash (0.5 sec on, 0.2 sec off). This indicates that Input port **2** is now connected to Output ports **2**, **3** and **4**.



Once the signal from the selected Input port is successfully tied to the Output port, the LEDs turn off and the LCD information is updated.

Note: 1. Pressing an Input port a second time deselects it.

- Input ports that are not configured or tied to any output port do not appear in the LCD screen.
 - Pressing the **Cancel** pushbutton once stops the Input Port Selection operation and the LCD displays the active setting. Pressing the **Cancel** pushbutton again turns all LEDs off.
 - After 10 seconds of inactivity, all the LEDs turn off.
-

Output Port Selection

Use the Output Port pushbuttons to select the Output port you want to configure.

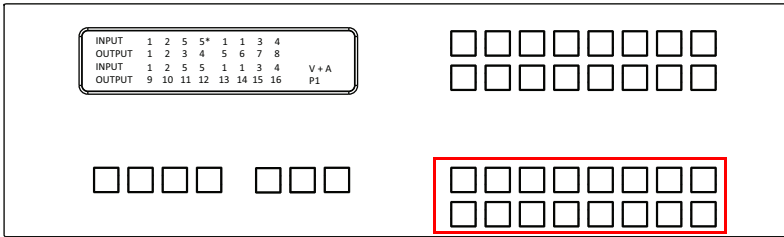

To select which output display corresponds to each input source, do the following:

1. Press any Output port pushbutton (1-16). The selected Output port LED lights steady.

In the example below, Output port **1** pushbutton has been pressed.

Available Input ports light up. Because no Input LEDs are flashing, no ports have already been assigned to Output port **1**.



2. If an Output port pushbutton is pressed a second time, it is deselected and the LED turns off.
3. To connect the selected Output port(s) to an Input port, press the Input port pushbutton to which you want the Output port(s) tied. The newly selected Input port LED flashes (0.5 sec on, 0.2 sec off), and the LCD information is updated.

In the example below, pressing Input port **2** ties it to Output ports **2, 3** and **4**.



- To switch Output ports **2**, **3** and **4** to another Input port (and disconnect it from Input port **2**), press another Input port pushbutton to which you want them tied.

In the example below, Input port **3** has been pressed and is now connected to Output ports **2**, **3** and **4**.



-
- Note:**
- Pressing an Output port a second time deselects it.
 - Pressing the **Cancel** pushbutton once stops the Output Port Selection operation, and the LCD displays the active setting. Pressing the **Cancel** pushbutton again turns all LEDs off.
 - After 10 seconds of inactivity, all the LEDs turn off.
-

Profile Pushbutton

From the Main screen; pressing the **PROFILE** pushbutton switches between the connection profiles added to the Profile Selection list (see *Profile List*, page 59). If a connection profile is in use, it is shown from the Main screen on the lower right corner of the LCD display.

INPUT	1	2	5	5*	1	1	3	4		
OUTPUT	1	2	3	4	5	6	7	8		
INPUT	1	2	5	5	1	1	3	4	V + A	
OUTPUT	9	10	11	12	13	14	15	16	P1	



- ◆ Use the front panel number pushbuttons to select a profile:
 - ◆ **Input** ports 1–16 correspond to Profile **P1** to **P16**
 - ◆ **Output** ports 1–16 correspond to Profile **P17** to **P32**

Note: If a Profile is available for selection, its corresponding Input/Output port LED lights.

The selected pushbutton lights steady, and the VM1600 immediately applies the port connections configured in the Profile. The selected Profile is shown as **P1-P32** in the LCD's lower right corner.

- ◆ **Up** and **Down** buttons correspond to the previous or next profile in the Profile List, which can be edited via the GUI.

If there are no profiles configured, an error message “*No Profile List defined. Profile List can be edited via the Web GUI.*” is displayed.

- ◆ The Profile List and connections can be edited from the *Profile List* page of the Browser GUI. See *Profile List*, page 59.
- ◆ Press the **Cancel** pushbutton to turn off the Profile LED.
- ◆ Pressing the **Profile** pushbutton for longer than 3 seconds displays the Save to a Profile page (see *Save to a Profile*, page 54).

Note: To save a configuration to a profile using the Front Panel pushbuttons, follow the steps in *Save to a Profile*, page 54.

LCD Menu

Use the **Menu** pushbutton to switch between the Main Screen and Menu page. From the Main Screen press the **Menu** pushbutton to access the Menu page; use the pushbuttons (1-16) to cycle through the menu options, starting from IP Setting, in the order show in the table below:

Menu Page	Sub-Menu Page(s)			
IP Setting	IP Address			
	Subnet Mask			
	Gateway			
Serial Port Setting	Baud Rate	9600 / 19200 / 38400 / 115200		
Operation Mode	EDID	Default / Port1 / Remix / Customized		
	CEC	On / NA		
	OSD	On / NA		
	Output Status	Video	On / NA	
		Stereo Audio	01-16	
Output Resolution		01-16		
Security Mode	Mode	None		
		Password Enable		
		Lock Screen		
	Change Password	Old Password	New Password	
Save to a Profile	Save to a Profile No.	01-32		
Play/Stop the Profile Schedule				
Turn Video Wall Off				

Note: 1. The highlighted values are the default settings of the VM1600.

2. Upon VM1600 startup, check the front panel LCD to view the loading progress. If the LCD Menu fails to load, an error message displays. Reset the unit and try again.

LCD Main Screen

The Main Screen shows the Input–Output port pairs, with the Output ports shown in sequential order (1–16) at the bottom half.

INPUT	1	2	5	5*	1	1	3	4		
OUTPUT	1	2	3	4	5	6	7	8		
INPUT	1	2	5	5	1	1	3	4	V + A	
OUTPUT	9	10	11	12	13	14	15	16	P1	

- ◆ The front panel pushbutton label (1–16) corresponds to the **Input** ports and **Output** ports on the unit’s rear panel.
- ◆ Use the **Menu** pushbutton to go to the Menu page.
- ◆ Use the **Profile** pushbutton to switch between profile connections (see *Profile List*, page 59).

IP Setting

To view the VM1600's IP settings, press the **Menu** pushbutton (lights). This takes you to the Menu page, shown below:



1. From the Menu page:
 - ◆ Press **1** to go to the IP Setting page.
 - ◆ Press **2** to go to the Serial Port Setting page.
 - ◆ Press **3** to go to the Operation Mode page.
 - ◆ Press **4** to go to the Security Mode page.
 - ◆ Press **Down** button to go to the next page.
 - ◆ Press **Menu** to return to the Menu Screen.
 - ◆ Press **Cancel** to return to the Main Screen.
2. After pressing **1**, the IP address, Subnet Mask and Gateway information are shown:

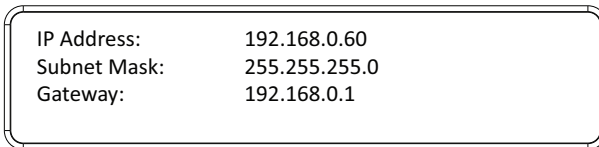

- ◆ The default IP address is 192.168.0.60.
 - ◆ The default Subnet Mask is 255.255.255.0.
 - ◆ The default Gateway is 192.168.0.1.
3. Press **Cancel** to return to the previous step without change.

Serial Port Setting

To configure the VM1600's serial port settings, select Serial Port Setting from the Menu page.

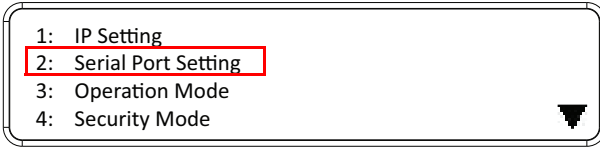

Serial Port Address Setting

To set the VM1600's serial port address, do the following:

1. Select **Serial Port Address Setting** from the Serial Port Setting submenu by pressing **1**:

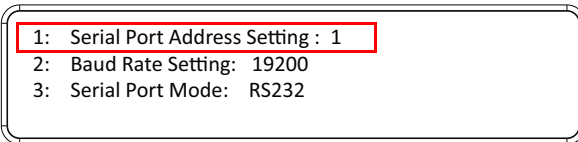

2. Press pushbuttons 1–16 to make your selection.

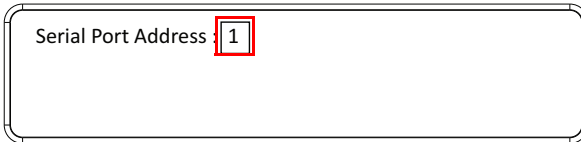

Note: The default serial port address is 1. This address is used for RS422/485 commands to control multiple VM1600's.

3. Press **Menu** to return to the Menu page.
4. Press **Cancel** to return to the previous step without saving.

Baud Rate

1. Select **Baud Rate Setting** from the Serial Port Setting submenu by pressing **2**:

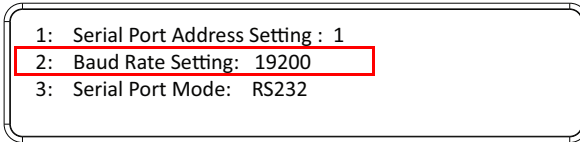

2. Press pushbuttons 1–4 to make your selection.

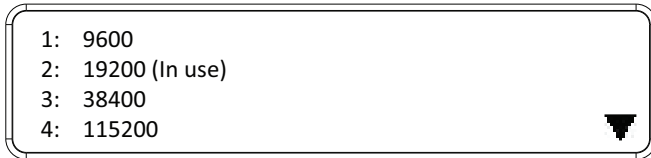

Baud Rate options are:

- ◆ 1: 9600
- ◆ 2: 19200
- ◆ 3: 38400
- ◆ 4: 115200

Note: The default baud rate is 19200.

3. Press **Menu** to return to the Menu page.
4. Press **Cancel** to return to the previous step without saving.

Serial Port Mode

1. Select **Serial Port Mode** from the Serial Port Setting submenu by pressing **3**:

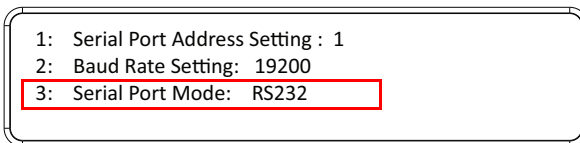

2. Press pushbuttons 1–2 to make your selection.

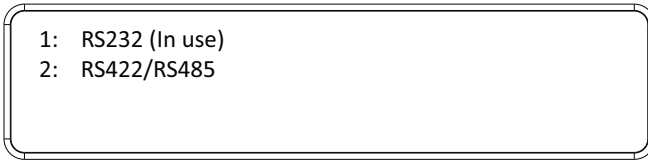

Serial Port options are:

- ◆ **1:** RS-232
- ◆ **2:** RS-422 / RS-485

Note: The default serial port mode is RS-232.

3. Press **Menu** to return to the Menu page.
4. Press **Cancel** to return to the previous step without saving.

Operation Mode

The EDID, CEC, OSD and Output Status features are adjusted from the Operation Mode menu.



- ◆ EDID (extended display identification data) is used to apply a preset video configuration (EDID Mode), which utilizes the best resolution across different monitors.
- ◆ Consumer Electronics Control (CEC) allows interconnected HDMI devices to communicate and respond to one remote control.
- ◆ The OSD, when enabled for a port, displays real-time port switching information on the screen.
- ◆ The Output Status shows whether the video/audio of an Output port is turned on or off.

EDID

To adjust the EDID mode, do the following:

1. From the Operation page, press pushbutton **1** to access the EDID Mode page:

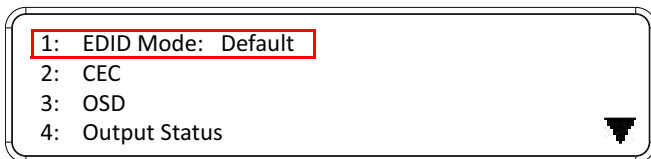

2. Press pushbuttons 1-4 to make your selection.

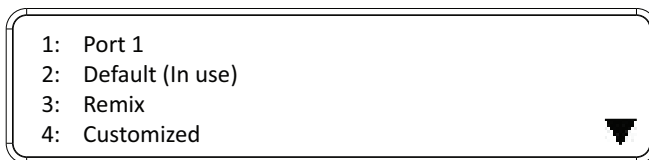

EDID Mode options are:

EDID Option	Description
1: Default	ATEN's default EDID data is passed to all video sources by default when the system is powered on.
2: Port1	EDID data read from port 1 is passed to all video sources. The system will enforce the Default EDID setting if port 1 is not occupied.
3: Remix	This mode reads the EDID data from all connected displays and generates the optimum EDID for all video sources. The system will not re-generate a new EDID when a new device is plugged in, unless triggered by a pushbutton or command.
4: Customized	This mode features an EDID Wizard that allows user-defined EDID configurations for optimum output. See <i>Customized Mode</i> , page 93.

3. Press **Menu** to return to the Menu page.
4. Press **Cancel** to return to the previous step without change.

Note: The default EDID setting is Default.

CEC

To configure the CEC settings, do the following:

1. From the Operation page, press pushbutton **2** to access the CEC page:

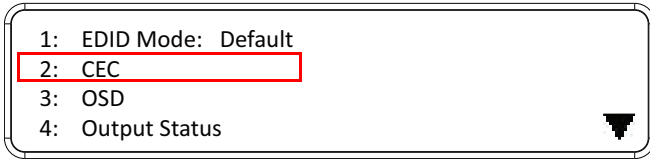

2. Press pushbuttons 1–16 to enable (**ON**) or disable (**NA**) the CEC feature for the output port. If the port does not support CEC, an **NA** is shown.

OUTPUT	1	2	3	4	5	6	7	8
	NA	NA	NA	NA	ON	NA	ON	NA
OUTPUT	9	10	11	12	13	14	15	16
	ON	ON	ON	ON	NA	NA	NA	NA

Note: The default CEC setting is Off.

3. Press **Menu** to return to the Menu page.
4. Press **Cancel** to return to the previous step without saving.

OSD

The On-Screen Display or OSD feature enables real-time text updates to appear on the display device's screen for any configuration changes made to the Output port via the VM1600's front panel, remote control or Web GUI.

To configure the OSD setting for each output port, do the following:

1. From the Operation page, press pushbutton **3** to access the OSD page:

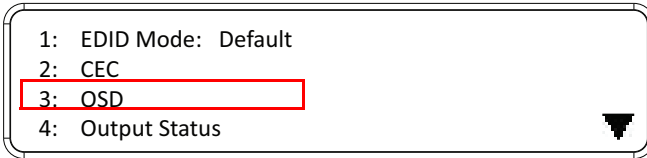

2. Press pushbuttons 1–16 to enable (**ON**) or disable (**NA**) the OSD feature for the port.

OUTPUT	1	2	3	4	5	6	7	8
	NA	NA	NA	NA	ON	NA	ON	NA
OUTPUT	9	10	11	12	13	14	15	16
	ON	ON	ON	ON	NA	NA	NA	NA

Note: The default OSD setting is Off.

3. Press **Menu** to return to the Menu page.
4. Press **Cancel** to return to the previous step without saving.

Output Status

To configure the Output Status settings for each output port, do the following:

- From the Operation Mode screen, press pushbutton **4** to access the Output Status page:

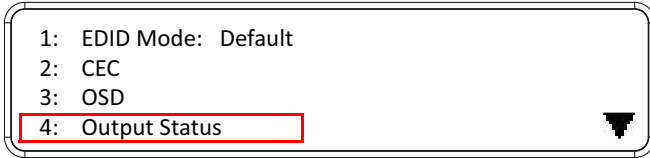

- Press pushbuttons 1–3 to select whether you want to configure the video, stereo audio, or output resolution for output ports.



- If configuring the output port status for video, press pushbuttons 1–16 to enable (**ON**) or disable (**NA**) the video channel:

OUTPUT	1	2	3	4	5	6	7	8
	NA	NA	NA	NA	ON	NA	ON	NA
OUTPUT	9	10	11	12	13	14	15	16
	ON	ON	ON	ON	NA	NA	NA	NA

Note: The default Output Status setting is On.

- If configuring the output port status for stereo audio, press pushbuttons 1–16 to select the output port. Adjust the audio volume for the port by pressing the **Up** or **Down** pushbutton:

OUTPUT	1	2	3	4	5	6	7	8
	0	10	[1]	4	8	8	8	8
OUTPUT	9	10	11	12	13	14	15	16
	0	10	10	4	8	8	8	8

Note: The audio volume range from 0 (mute) and 1 (~27dB) to 10 (0dB). The default audio volume is 10.

5. If configuring the output video resolution, press pushbuttons 1–16 to select the output port. Next, select the preferred output resolution.
6. Press **Menu** to return to the Menu page.
7. Press **Cancel** to return to the previous step without saving.

Security Mode

The Security Mode page allows you to configure the VM1600's password-related settings; the **Password** page sets the VM1600 to require a password for local operation after the LCD display times out (default time out: 5 minutes) or is powered off/on. The **Change Password** option allows you to set a new password for the VM1600.

To configure the VM1600's password settings from the Main Screen, use the **Menu** pushbutton to access the Menu page, then press pushbutton **4** to access the Security Mode page.



Mode

1. To set the VM1600 so that it requires a password for local operation, press pushbutton **1** in the Security Mode page.

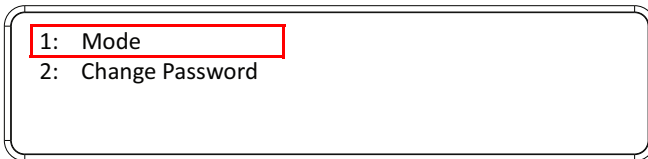

2. To disable security settings, press pushbutton **1**.
3. To require a password after the LCD display times out or is powered off/on, press pushbutton **2**.
4. To enable a lock screen, press pushbutton **3**. When Lock Screen is enabled, pressing any pushbutton from the home screen will trigger the following message: *Please press "Menu" to start.*

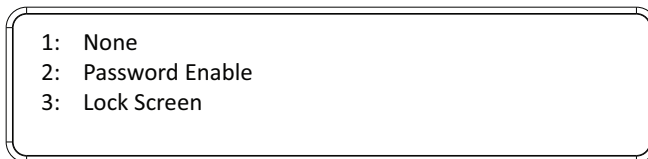

Note: By default the password requirement is disabled. If the password is enabled, the LCD display's default time-out is 5 minutes.

5. Press **Menu** to return to the Menu page.
6. Press **Cancel** to return to the previous step without saving.

Change Password

1. To change the password: from Security Mode, press pushbutton **2**.

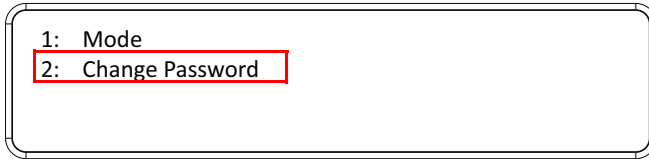

2. In the Old Password field, the cursor flashes at the first digit. Enter the old password (see *LCD Password*, page 32). If the old password is entered correctly, you can proceed to the next step. The default password is: **1234**.



Note: If you enter an incorrect password, the cursor goes back to the first digit and reverts to flashing. The Incorrect Password message clears as soon as a new digit is entered.

3. In the New Password field, the cursor flashes at the first digit. Enter the new password using the front panel number pushbuttons (1111–9999).



4. Re-enter the new password in the following screen. The new password is applied by the VM1600 immediately.

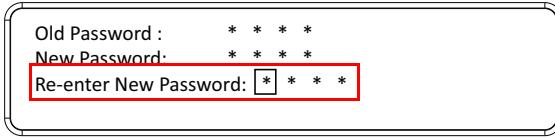

Old Password : * * * *
New Password: * * * *
Re-enter New Password: * * * *

The screenshot shows a password entry interface with three rows of text. The first row is 'Old Password : * * * *'. The second row is 'New Password: * * * *'. The third row is 'Re-enter New Password: * * * *'. A red rectangular box highlights the first character input field in the third row, which contains an asterisk, indicating a mismatch between the new password and the re-entered password.

If the password you entered does not match the one entered in the previous screen, an error message appears. Enter the new password correctly.

5. Press **Menu** to return to the Menu page.
6. Press **Cancel** to return to the previous step without saving.

Save to a Profile

The VM1600 allows you to store up to 32 (P1–P32) different connection profiles that can be saved and recalled later. When profiles are saved, they are saved according to the current connection configuration on the Main Screen. When you load a profile, the change is immediate and the profile number is shown in the lower right corner of the LCD display. To save profiles, from the Main Screen do the following:

1. Use the **Menu** pushbutton to access the Menu page, and **Down** to navigate to the next page. Press pushbutton **1** to open the Save to a Profile page.



2. To save the active connection configuration as a profile use the front panel number pushbuttons to select a profile into which you want to save the configuration.

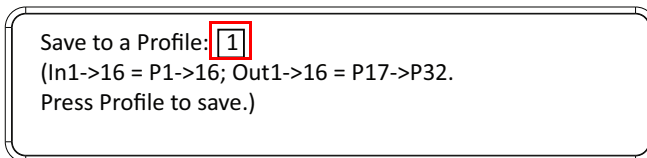

- ◆ Input ports **1–16** correspond to Profile **P1** to **P16**
 - ◆ Output ports **1–16** correspond to Profile **P17** to **P32**
3. Press the **Profile** pushbutton to store the connection configuration – the LCD shows a Profile Saved message.
 4. Press **Menu** to return to the Menu page.
 5. Press **Cancel** to return to the previous step without saving.

Note: You can also access the Save to a Profile page by pressing the **Profile** pushbutton for longer than 3 seconds.

Play/Stop the Profile Schedule

Inputting port pushbutton **2** will Play or Stop the active Profile Schedule.

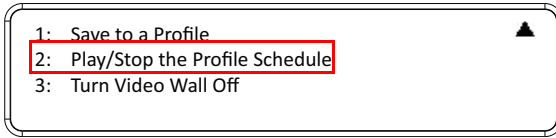

Turn Video Wall Off

If a video wall is currently playing, a submenu will appear.

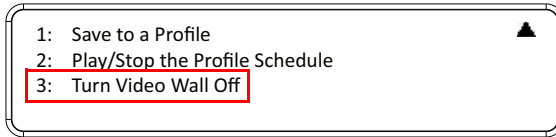

Selecting **Turn Video Wall Off** will return port assignments to their default (i.e. disassemble the video wall).

This Page Intentionally Left Blank

Chapter 4

Browser Operation

Overview

The VM1600 can be configured over a standard TCP/IP connection via its built-in Graphical User Interface (GUI). Because it can be accessed from anywhere over a network or the Internet, operators can easily log in via web browser. Security is ensured by password protection and user-configurable time-out. The VM1600 supports three levels of remote users with various privileges, and up to 32 users can log into the GUI at one time. For full details see the sections that follow.

Logging In

To access the GUI, type the VM1600's IP address into the address bar of any browser. If a Security Alert dialog box appears, accept the certificate – it can be trusted. The login screen appears:

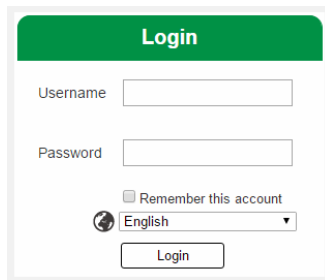

- ◆ The default IP address is **http://192.168.0.60**
- ◆ The default Username and Password are: **administrator / password**
- ◆ Enter the username and password, then click **Login**.
- ◆ Use the drop-down menu to select the GUI language

Note: 1. The username supports lower case letters only.
2. The same user can not be logged in simultaneously.

Main Page

The Main Page opens to the **Profile List**. This is where you configure the input to output connections by creating profiles. The page is divided into three parts: the *Menu Bar*, *Profile List*, and *Profile Scheduling*.

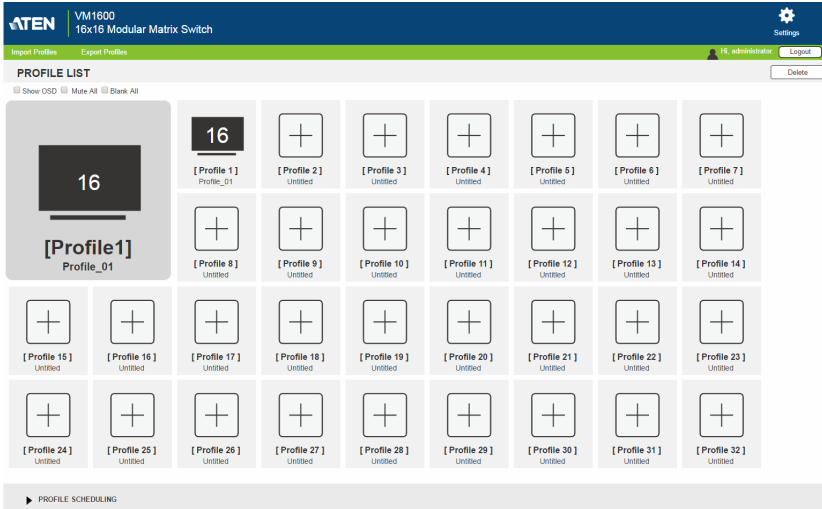

Menu Bar

The Menu Bar consists of the *Settings* icon and *Logout* button.

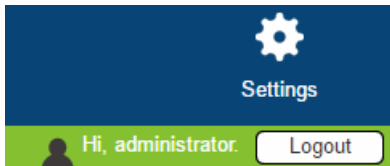

- ◆ Click **Settings** to enter the System Settings (see page 81).
- ◆ Click the **Logout** button to log out of the GUI.

Profile List

The *Profile List* lets you configure the input to output port connections by creating profiles to use. You can store up to 32 differently configured profiles that can be saved and played later by two methods: locally via the unit's front panel pushbuttons and via the web GUI.

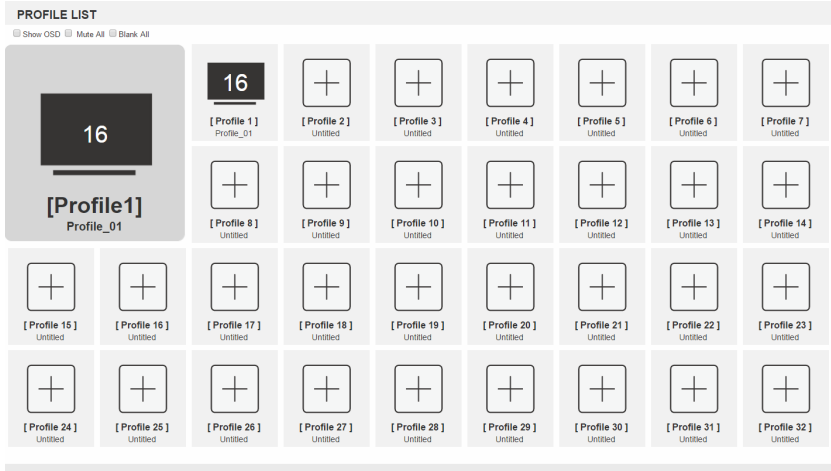

Adding/Playing a Profile

To configure a new or existing connection profile:

1. From the Profile List, click an empty or existing **[Profile]** icon.
2. For a new profile, select the profile type:



Digital Signage

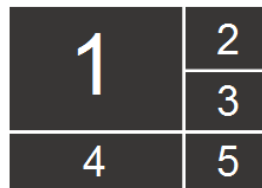

Video Wall

Digital Signage: Select this option for video that is displayed independently on separate monitors (page 67).

Video Wall: Select this option for monitors that are displayed together - tiled or as a large screen (page 70).

3. Configure the input to output connections for a Digital Signage (**page 67**) or Video Wall (**page 70**) profile.
4. Once you create a profile, it appears in the *Profile List*, as shown here:

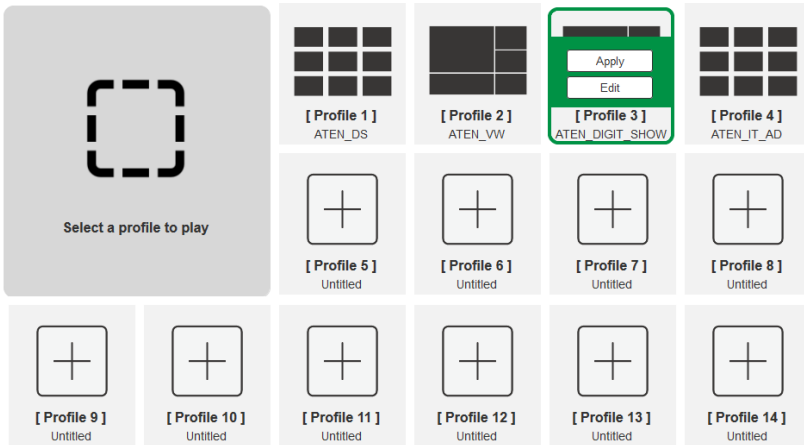

5. Select the profile and click **Apply**.
6. The profile appears in the large **Play** window and the connections start:

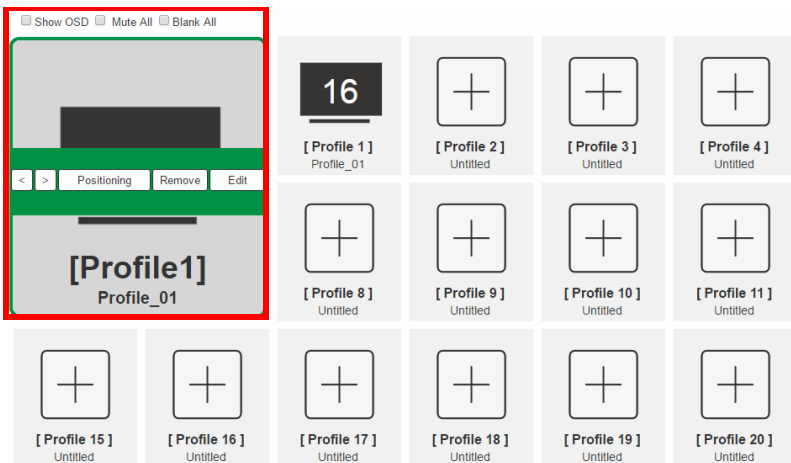

Note: More information about the Profile List is provided on the next page.

Importing/Exporting a Profile

To export the VM1600's connection profiles, do the following:

1. Click **Export Profiles**. A configuration file will then begin downloading.

To import connection profiles to the VM1600, do the following:

1. Click **Import Profiles**.
2. Browse to the configuration file, select it and click **Open**.

Note: Importing a connection profile database will overwrite the current profiles.

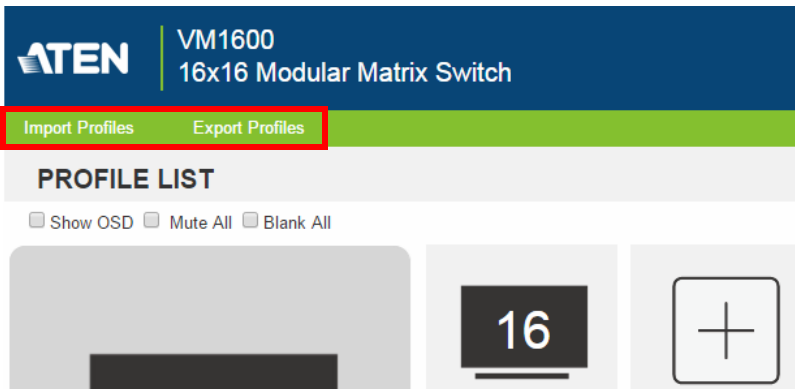

Profile List Options

Clicking a *Profile* or the *Play* window opens a pop-up menu with options.

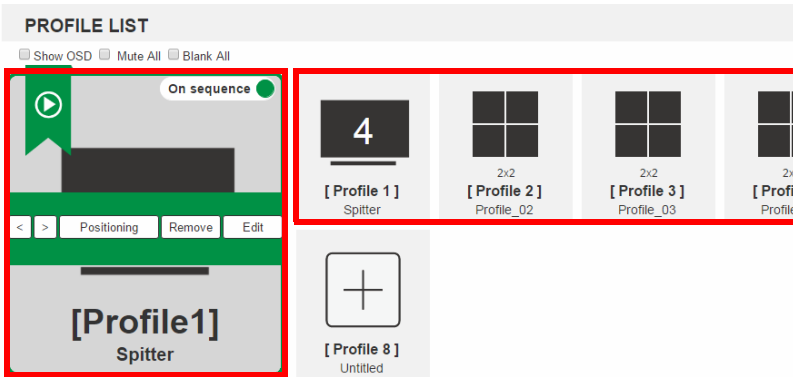

Profile

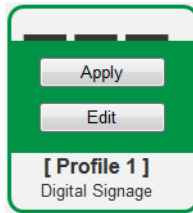

Option	Description
Apply	Click Apply to put the profile in the Play window. This allows you to start the profile connections.
Edit	Click Edit to configure the profile's input to output connections.

Play Window

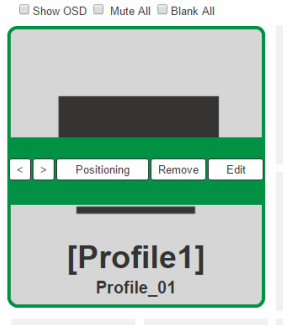

Option	Description
On Sequence	On Sequence will appear when a profile schedule is playing (see page 62).
<	Click < to go back to the previous profile in the sequence, when Profile Scheduling is in use. Only available with <i>On Sequence</i> .
>	Click > to advance to the next profile in the sequence, when Profile Scheduling is in use. Only available with <i>On Sequence</i> .
Positioning	Click Positioning to open a window that allows you to adjust the image position on each display. For Video Wall profiles, you can also set the Bezel Dimension, which is the frame thickness between each display.
Remove	Removes the profile from the Play window.
Edit	Click Edit to configure the profile's input to output connections.





Other

Option	Description
Show OSD	Check Show OSD to show text updates that appear on the display when configuration or port changes are made.
Mute All	Check Mute All to mute the audio for all ports.
Blank All	Check Blank All to turn off the video to all displays.

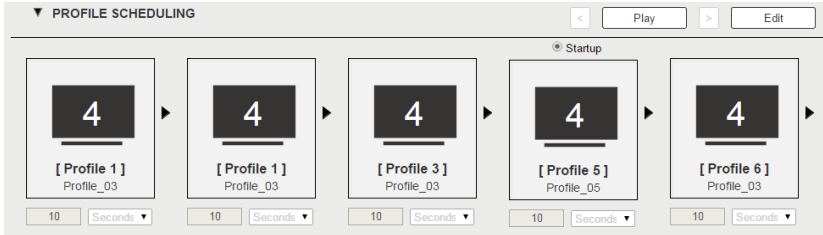
Profile Scheduling



Profile Scheduling is located below the Profile List. Scheduling allows you to queue and play connection profiles in sequence for a specific amount of time.

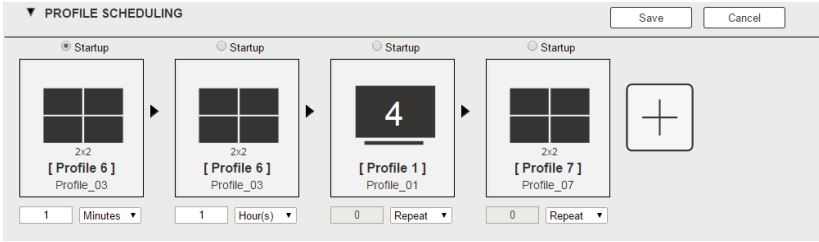

Option	Description
	Click to edit profile schedule.
	Click to play profile schedule.
	Click to stop profile schedule.
	Click to change to next or previous profile when a profile schedule is playing.

After selecting **Edit**, you will be presented with the following options.

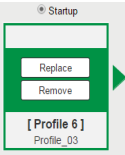

Option	Description
	Click to add profiles to the schedule in the order to be played, left to right, then set the amount of time each profile plays.
	Click a profile for a pop-up menu to appear: <ul style="list-style-type: none"> ◆ Select Startup to use the profile as the starting point for the schedule. ◆ Click Replace to replace the selected profile with another profile. ◆ Click Remove to delete the profile from the schedule. ◆ Use < > to change the profile's position in the schedule.
	Use the drop-down menu to select the duration (Hours, Minutes, or Seconds) and enter the amount of time for the profile to play. After the time expires, the schedule switches to the next profile. Use Repeat to stop switching between schedules and stay on the currently selected profile. If Repeat isn't used, the schedule will loop back to the first profile. If Repeat is used, a specific number of hours, minutes and seconds cannot be set and later profiles will not be played.
Save	Click Save to save the schedule as it appears. After saving, the Profile Scheduling window will close. When a Profile Schedule is playing the <i>On Sequence</i> box will appear in the Play window.
Cancel	Click Cancel to discard changes and return to the Profile Schedule page.

Connection Profiles

There are two types of profiles: *Digital Signage* and *Video Wall*. **Digital Signage** profiles are for displays where video is viewed on separate monitors. **Video Wall** profiles are for displays that are tiled together, where multiple monitors form one large screen – in various arrangements.

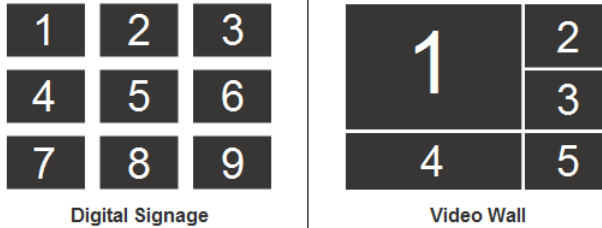

Digital Signage Profile

Each icon represents an output port and the connected display. The large number is the **Input** port selected for the display. The small number (upper-left corner) is the **Output** port for the display. Click the icons to select options.

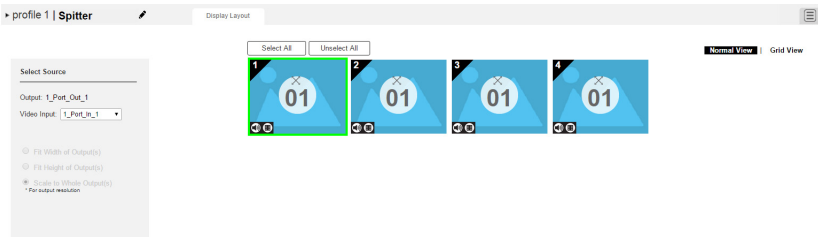

- ◆ Select icons to choose the **Video Input** from the *Select Source* menu.
- ◆ Click the PEN icon or name to edit the profile name.
- ◆ Click **Select All** to select all outputs.
- ◆ Click **Unselect All** to unselect all outputs.
- ◆ Click **Save** to save the profile or **Save as** to save as a different profile number.
- ◆ Click *Grid View* to use an alternate method for configuring connection profiles (see page 69).

Output Icon



Option	Description
Output Icon	Click an Output icon(s) to highlight it in green and use the <i>Select Source</i> menu to set the video options (see <i>Select Source</i> below). The large number is the Video Input port selected for the display. The small number (upper-left corner) is the Output port of the display.
Mute / Video 	Click the speaker icon to mute the audio on/off. Click the video icon to turn the video off/on.

Select Source

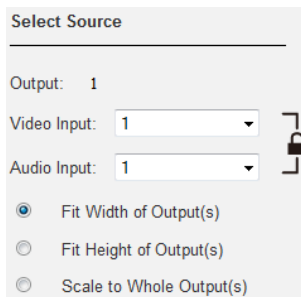

Option	Description
Select Source	The Select Source menu appears when you click an Output icon.
Video Input	Use the drop-down menu to select the Video Input port.
Audio Input	Use the drop-down menu to select the Audio Input source.
Lock / Unlock 	Lock the icon to set the same source for the Video/Audio Input: when one is changed the other changes to match it. Unlock the icon to set different sources for the Video and Audio port.
Radio Button	<ul style="list-style-type: none"> ◆ Fit Width of Output(s): fits the video to the width of the display. ◆ Fit Height of Output(s): fits the video to the height of the display. ◆ Scale to Whole Output(s): fits the video on the entire display.

Grid View

The Traditional View allows you to select the **Input** to **Output** and **Audio** connections using a simple grid.

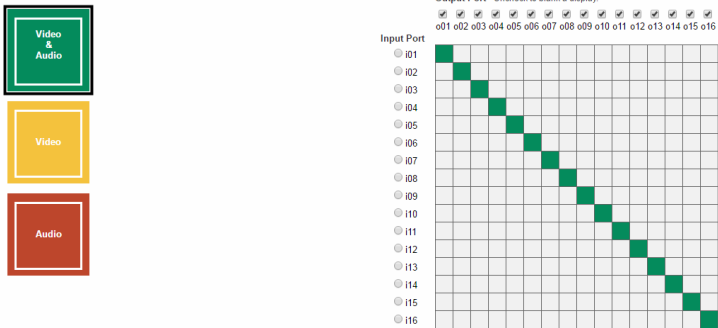

- ◆ Select: **Video & Audio**, **Video**, or **Audio** to set the input to output connection for the selected source.
- ◆ From an *Output Port* column, click a box to select its **Input Port**. The box will turn green, yellow or red.
- ◆ **Uncheck** an *Output Port* box to disable the video for that Output Port. The column will turn dark grey.
- ◆ **Check** an *Output Port* box to enable the video for that Output Port
- ◆ Click **Test** to play the current profile without saving.
- ◆ Click **Save & Apply** to save a profile and begin playing it.
- ◆ Click **Save** to save the profile.
- ◆ Click **Save as** to save the profile as a different profile number.
- ◆ Click **Cancel** to undo all unsaved changes.

Output Options

For instructions on the *Output Options* page, see *Output Options*, page 77.

Video Wall Profile

Each blank icon represents an Output port and the connected display. Use the icons to create Independent and Grouped Outputs. **Independent** Outputs will display video on a single monitor. **Grouped** Outputs will display video across multiple monitors as one large screen.

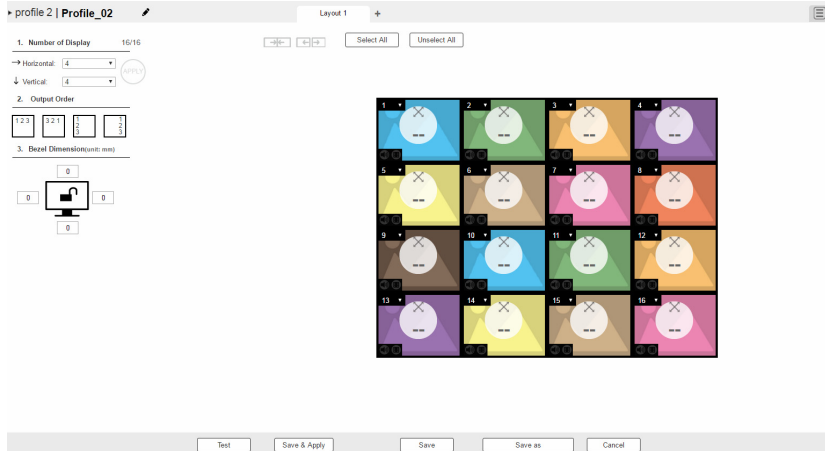

Video Wall Options

- ◆ Click an icon to choose its **Output** and **Video Input** from the *Display Preference* menu (see page 74).
- ◆ Click multiple icons to Group Outputs (see *Grouping*, page 73) and choose the **Video Input** from the *Display Preference* menu.
- ◆ Use **+** next to **Display Layout_1** to create additional layouts under the same profile.
- ◆ Click the PEN icon or name to edit the profile name.
- ◆ Click **Select All** to select all outputs.
- ◆ Click **Unselect All** to unselect all outputs.
- ◆ Click **Test** to play the current profile without saving.
- ◆ Click **Save & Apply** to save the profile and put it in the Play window (see page 63).
- ◆ Click **Save** to save the profile.
- ◆ Click **Save as** to save the profile as a different profile number.
- ◆ Click **Cancel** to discard changes and return to the Profile List.

Number of Displays / Output Order / Bezel Dimensions

1. Number of Display 04/04

→ Horizontal: ▼

↓ Vertical: ▼

2. Output Order

1
2
3

3
2
1

1
2
3

1
2
3

3. Bezel Dimension(unit: mm)



30

30



30

30

Option	Description
Number of Displays	Use the <i>Horizontal</i> and <i>Vertical</i> drop-down menu to select the number of displays that make up the video wall (a maximum of 64 are supported). Match this to the physical layout of the displays. Click Apply to set the layout.
Output Order	Automatically assign output ports by selecting one of the following options: Left to right (top to bottom), right to left (top to bottom), top to bottom (left to right) or top to bottom (right to left).
Bezel Dimension	Use the four boxes to increase/decrease the frame size for each active display.
Monitor Lock / Unlock  	Click the monitor icon to Lock the (4) bezel settings, so that when one size is changed they all change. Click the monitor icon to Unlock the (4) bezel settings, so that each size can be set independently.

Null Input



Option	Description
Null Icon	<p>Click Null Input icons to highlight icons in green and use the Display Preferences menu to set the video options (see <i>Display Preferences</i>, page 74).</p> <p>Select a single icon to set the Output and Video Input for an independent display (see <i>Independent Output</i>, page 72).</p> <p>Select multiple icons and set the Video Input to group displays as one screen (see <i>Grouping</i>, page 73). <i>You must first set the Output port for each icon.</i></p>
Drop-Down Menu	Use the drop-down menu to select the Output port.

Independent Output

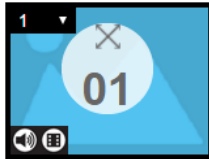

Option	Description
Independent	<p>Independent Outputs are displays that have their own Video Input and Output selected. Independent Outputs:</p> <ul style="list-style-type: none"> ◆ Display their own video ◆ Icons have their own color and Video Input <p>Select an Independent Output and use the <i>Display Preferences</i> menu to select the Video Input (see page 74).</p>
Drop-down Menu	Use the drop-down menu (top-right corner) to select the Output port.
Mute / Video	<p>Click the speaker icon to mute the audio on/off.</p> <p>Click the video icon to turn the video off/on.</p>

Grouping

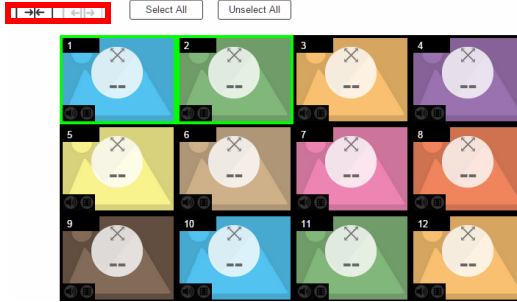

Option	Description
Grouping	Click multiple icons to Group Outputs (highlighted in green) and click → ← to group the displays into one screen. Use the Display Preferences menu to select the Video Input for the group - each Output icon in the Group will appear with the same Video Input number and icon color (see page 73).
Ungroup	Select a group and click ← → to ungroup the displays.

Group

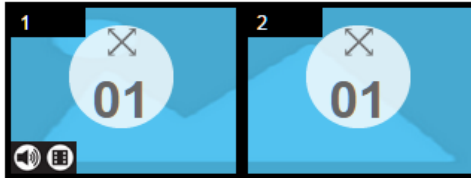

Option	Description
Group	<p>A Group (of Outputs) shares the same Video Input and displays the video together as one large screen. A Group of Outputs:</p> <ul style="list-style-type: none"> ◆ Displays video across multiple monitors to form one screen ◆ Icons have the same color and Video Input number. ◆ Select a Group and use the <i>Display Preferences</i> menu to select the Video Input. ◆ To group outputs see <i>Grouping</i>, page 73.
Mute / Video	<p>Click the speaker icon to mute the audio on/off. Click the video icon to turn the video off/on.</p>



Display Preferences

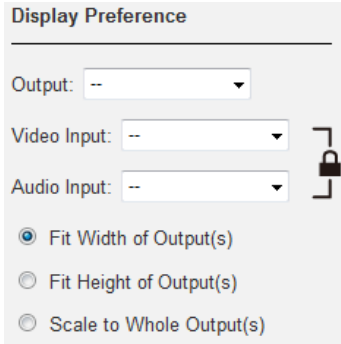

Option	Description
Display Preferences	Click Output icons for the Display Preferences menu to appear– to select the Output and/or Video Input port.
Output	Use the drop-down menu to select the Output port (Independent and single Blank icons only). If you select multiple displays the output ports selected will appear here. You can use the output icon's drop-down menu to change the output port for the display.
Video Input	Use the drop-down menu to select the Video Input port.
Audio Input	Use the drop-down menu to select the Audio Input source.
Lock / Unlock 	Lock the icon to set the same source for the Video and Audio Input: when one is changed the other changes to match it. Unlock the icon to set different sources for the Video and Audio port.
Radio Button	<ul style="list-style-type: none"> ♦ Fit Width of Output(s): fits the video to the width of the display. ♦ Fit Height of Output(s): fits the video to the height of the display. ♦ Scale to Whole Output(s): fits the video on the entire display.

Video Wall Example 1

The example below shows a video wall with 8 displays.

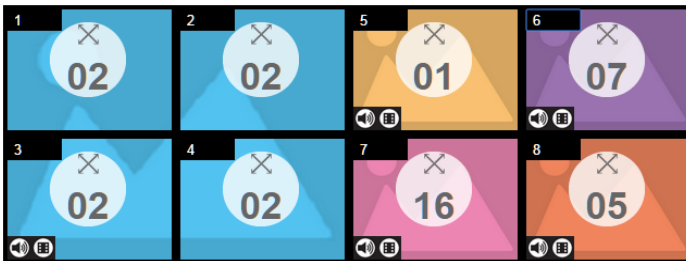

- ◆ Each Group and Independent Output has a unique color.
- ◆ This video wall has 1 **Group** and 4 **Independent** displays.
- ◆ The Group will show **Video Input 02** across all four displays as one large screen.
- ◆ The Independent displays will show the video from their own **Video Input** – 01, 07, 16 and 05.
- ◆ Add Display Layouts to create separate video walls (see *Video Wall Options*, page 70).

Video Wall Example 2

The example below shows a video wall with 16 displays.



- ◆ Each Group and Independent Output has a unique color.
- ◆ This video wall has 3 *Groups* and 2 *Independent* displays.
 - ◆ The *Blue* Group will show **Video Input 02** across six displays as one large screen.
 - ◆ The *Brown* Group will show **Video Input 05** across six displays as one large screen (as if *Video Input 06* is a missing part of the entire screen).
 - ◆ The *Yellow* Group will show **Video Input 06** across two displays as one screen.

- ♦ The *Orange* and *Purple* Independent displays will show the video from their own **Video Input** – 03 and 04.

Output Options

The *Output Options* page is used to configure HDMI Audio Controls, HDMI Video Options, and Other Options (OSD/CEC).

HDMI Audio Control

HDMI Audio Control

Port	HDMI Control		Stereo Control		Stereo_volume	
	Apply to All	Apply to All	Apply to All	Apply to All	Apply to All	Apply to All
Port1	HDMI	Use HDMI Audio	Stereo	Use Stereo Audio	+ -	Vol. 10 - +
Port2	HDMI	Use HDMI Audio	Stereo	Use Stereo Audio	+ -	Vol. 10 - +
Port3	HDMI	Use HDMI Audio	Stereo	Use Stereo Audio	+ -	Vol. 10 - +
Port4	HDMI	Use HDMI Audio	Stereo	Use Stereo Audio	+ -	Vol. 10 - +
Port5	HDMI	Use HDMI Audio	Stereo	Use Stereo Audio	+ -	Vol. 10 - +
Port6	HDMI	Use HDMI Audio	Stereo	Use Stereo Audio	+ -	Vol. 10 - +
Port7	HDMI	Use HDMI Audio	Stereo	Use Stereo Audio	+ -	Vol. 10 - +
Port8	HDMI	Use HDMI Audio	Stereo	Use Stereo Audio	+ -	Vol. 10 - +
Port9	HDMI	Use HDMI Audio	Stereo	Use Stereo Audio	+ -	Vol. 10 - +
Port10	HDMI	Use HDMI Audio	Stereo	Use Stereo Audio	+ -	Vol. 10 - +
Port11	HDMI	Use HDMI Audio	Stereo	Use Stereo Audio	+ -	Vol. 10 - +
Port12	HDMI	Use HDMI Audio	Stereo	Use Stereo Audio	+ -	Vol. 10 - +
Port13	HDMI	Use HDMI Audio	Stereo	Use Stereo Audio	+ -	Vol. 10 - +
Port14	HDMI	Use HDMI Audio	Stereo	Use Stereo Audio	+ -	Vol. 10 - +
Port15	HDMI	Use HDMI Audio	Stereo	Use Stereo Audio	+ -	Vol. 10 - +
Port16	HDMI	Use HDMI Audio	Stereo	Use Stereo Audio	+ -	Vol. 10 - +

- ◆ **HDMI / Stereo Control:** Use the drop-down menu to apply audio setting to all ports:
 - ◆ *All Ports Use HDMI Audio.*
 - ◆ *All Ports Use Stereo Audio* (uses the stereo audio port).
 - ◆ *All Mute:* mutes all ports.
- ◆ **Port_ HDMI / Stereo:** Use the drop-down menu to apply audio settings to each port:
 - ◆ *Use HDMI Audio:* port uses the HDMI audio.
 - ◆ *Use Stereo Audio:* port uses the Stereo audio.
 - ◆ *Mute:* mutes HDMI/Stereo for the selected port.
- ◆ **Stereo Volume:** Use + *and* - to increase or decrease the audio level.
- ◆ Click **Test** to play current profile without saving.

- ◆ Click **Save & Apply** to save a profile and begin playing it.
- ◆ Click **Save** to save the profile.
- ◆ Click **Save as** to save the profile as a different profile number.
- ◆ Click **Cancel** to undo all unsaved changes.

HDMI Video Options

HDMI Video Options allow you to set Seamless Switch options which determine how a display performs when the Input port is changed.

Port	*Seamless Switch	Transition	Period	Scale Resolution
	Apply to All	Apply to All	Apply to All	Apply to All
Port1	<input checked="" type="checkbox"/> ON	<input type="checkbox"/> OFF	Normal	1920x1080@60Hz(720)
Port2	<input checked="" type="checkbox"/> ON	<input type="checkbox"/> OFF	Normal	1920x1080@60Hz(720)
Port3	<input checked="" type="checkbox"/> ON	<input type="checkbox"/> OFF	Normal	1920x1080@60Hz(720)
Port4	<input checked="" type="checkbox"/> ON	<input type="checkbox"/> OFF	Normal	1920x1080@60Hz(720)
Port5	<input checked="" type="checkbox"/> ON	<input type="checkbox"/> OFF	Normal	1920x1080@60Hz(720)
Port6	<input checked="" type="checkbox"/> ON	<input type="checkbox"/> OFF	Normal	1920x1080@60Hz(720)
Port7	<input checked="" type="checkbox"/> ON	<input type="checkbox"/> OFF	Normal	1920x1080@60Hz(720)
Port8	<input checked="" type="checkbox"/> ON	<input type="checkbox"/> OFF	Normal	1920x1080@60Hz(720)
Port9	<input checked="" type="checkbox"/> ON	<input type="checkbox"/> OFF	Normal	1920x1080@60Hz(720)
Port10	<input checked="" type="checkbox"/> ON	<input type="checkbox"/> OFF	Normal	1920x1080@60Hz(720)
Port11	<input checked="" type="checkbox"/> ON	<input type="checkbox"/> OFF	Normal	1920x1080@60Hz(720)
Port12	<input checked="" type="checkbox"/> ON	<input type="checkbox"/> OFF	Normal	1920x1080@60Hz(720)
Port13	<input checked="" type="checkbox"/> ON	<input type="checkbox"/> OFF	Normal	1920x1080@60Hz(720)
Port14	<input checked="" type="checkbox"/> ON	<input type="checkbox"/> OFF	Normal	1920x1080@60Hz(720)
Port15	<input checked="" type="checkbox"/> ON	<input type="checkbox"/> OFF	Normal	1920x1080@60Hz(720)
Port16	<input checked="" type="checkbox"/> ON	<input type="checkbox"/> OFF	Normal	1920x1080@60Hz(720)

*Seamless switch can not be turned off at video wall editor

The *Transition*, *Period* and *Scale Resolution* apply only when Seamless Switching is on.

- ◆ **Seamless Switch:** Turning *Seamless Switch* on removes the video distortion and delay seen when an Input port is switched.
 - ◆ Use the drop-down menu to apply options to all ports, or the On/Off button to enable/disable Seamless Switching per port.
- ◆ **Transition:** Allows you to fade the video display when the Input port is changed. Use the period option to set the fade speed.
 - ◆ Use the drop-down menu to apply options to all ports, or On/Off button to enable/disable Transition per port.
- ◆ **Period:** Sets the fade speed for the Transition option.
 - ◆ Use the drop-down menu to apply an option (*Slow*, *Normal*, or *Fast*) to all ports, or lower drop-down menus to apply options per port.
- ◆ **Scale Resolution:** Forces the port to scale the video displayed to the selected resolution.
 - ◆ Use the top drop-down menu to apply an option to all ports, or lower drop-down menus to apply options per port.
- ◆ Click **Test** to play current profile without saving.
- ◆ Click **Save & Apply** to save a profile and begin playing it.

- ◆ Click **Save** to save the profile.
- ◆ Click **Save as** to save the profile as a different profile number.
- ◆ Click **Cancel** to undo all unsaved changes.

System Settings

Click the *Settings* link from the Main page for the System Settings to open on the **General** page:

Serial Settings

Serial Port Mode: RS232 Serial Port Address: 01

Fan status

39 °C Fan Speed: Auto

Power Status

Primary Power: OK Redundant Power: N/A

Device Info

Device	Model Name	FW Version	Temperature	Power Consumption
▼ Video Matrix	VM1600	V2.0.199	--	--
▶ Input Slot1	--	--	--	--
▶ Input Slot2	--	--	--	--
▶ Input Slot3	--	--	--	--
▶ Input Slot4	--	--	--	--
▼ Output Slot1	VM8804	V1.5.144	32°C	23W
Port1: Port2: Port3: Port4:				
▼ Output Slot2	VM8604	V2.0.193	32°C	26W
Port5: Port6: Port7: Port8:				
▶ Output Slot3	--	--	--	--
▶ Output Slot4	--	--	--	--

Other

Language: English Baud Rate: 19200

Save Cancel

- ◆ The *General* page allows you to view and set Serial, Fan, Language and Baud Rate Settings. Here you can also view Temperature, Fan and Power statuses and Slot Information.
- ◆ The *User Account* page allows you to add and edit user accounts.
- ◆ The *Port Name* page allows you to name each input and output port.
- ◆ The *Network* page allows configuration of the network settings.
- ◆ The *EDID* page is used to set the EDID modes.
- ◆ The *Maintenance* page is for upgrading the device's firmware.
- ◆ The *IR/RS232 Channel* page allows you to set the IR and RS232 channel settings*.

- ◆ The *OSD/CEC* page allows users to control port OSD and CEC settings.
- ◆ Click **Profile List** to return to the Main page.

Note: The *IR/RS232 Channel* page is only available when VM7514/VM8514 I/O boards are installed in the VM1600.

General

The *General* page has three sections: Serial Settings, Fan Status, Power Status, Device Info and Other.

Serial Settings

Serial Port Mode RS232 Serial Port Address 01

Fan status

39°C

Fan Speed Auto

Power Status

Primary Power

OK

Redundant Power

N/A

Device Info

Device	Model Name	F/W Version	Temperature	Power Consumption								
▼ Video Matrix	VM1600	V2.0.199	--	--								
▶ Input Slot1	--	--	--	--								
▶ Input Slot2	--	--	--	--								
▶ Input Slot3	--	--	--	--								
▶ Input Slot4	--	--	--	--								
▼ Output Slot1	VM8804	V1.5.144	32°C	23W								
<table border="1" style="width: 100%; border-collapse: collapse;"> <tr><td>Port1</td><td style="text-align: center;">✖</td></tr> <tr><td>Port2</td><td style="text-align: center;">✖</td></tr> <tr><td>Port3</td><td style="text-align: center;">✖</td></tr> <tr><td>Port4</td><td style="text-align: center;">—</td></tr> </table>					Port1	✖	Port2	✖	Port3	✖	Port4	—
Port1	✖											
Port2	✖											
Port3	✖											
Port4	—											
▼ Output Slot2	VM8604	V2.0.193	32°C	26W								
<table border="1" style="width: 100%; border-collapse: collapse;"> <tr><td>Port5</td><td style="text-align: center;">✖</td></tr> <tr><td>Port6</td><td style="text-align: center;">✖</td></tr> <tr><td>Port7</td><td style="text-align: center;">✖</td></tr> <tr><td>Port8</td><td style="text-align: center;">✖</td></tr> </table>					Port5	✖	Port6	✖	Port7	✖	Port8	✖
Port5	✖											
Port6	✖											
Port7	✖											
Port8	✖											
▶ Output Slot3	--	--	--	--								
▶ Output Slot4	--	--	--	--								

Other

Language English Baud Rate 19200

Serial Settings

- ◆ Use the *Serial Port Mode* drop-down menu to select a signal for the serial port: RS232, RS422/RS485.
- ◆ If you are using RS422/RS485, select the *Serial Port Address*. Options are: 1-16.
- ◆ Use the drop-down menu to select the *Baud Rate* for the serial port.

Fan Status

This section displays the internal temperature and status of the cooling fans.

- ◆ Fans rotate to indicate they are working.

Note: If the fans have stopped working or are switched off, they will appear as follows. The fan module will then need to be replaced or reset.



Power Status

This section displays the status of the Primary and Redundant Power units.

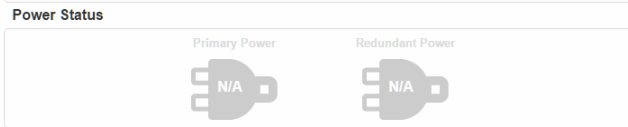

Device Info

This section lists the device and input/output boards' type, Model Name, Firmware Version, Temperature and Power Consumption.

Device Info				
Device	Model Name	F/W Version	Temperature	Power Consumption
▼ Video Matrix	VM1600	V2.0.199	--	--
▶ Input Slot1	--	--	--	--
▶ Input Slot2	--	--	--	--
▶ Input Slot3	--	--	--	--
▶ Input Slot4	--	--	--	--
▼ Output Slot1	VM8804	V1.5.144	32°C	23W

Port1	✘
Port2	✘
Port3	✘
Port4	—

Other

- ◆ Use the **Language** drop-down menu to select a preferred user interface language.
 - ◆ Options include: English, French, German, Italian, Japanese, Korean, Portuguese, Russian, Spanish, Simplified Chinese and Traditional Chinese.
- ◆ Use the **Baud Rate** drop-down menu to select a serial port setting.
- ◆ Options include: 9600, 19200, 38400 and 115200.

User Account

The *User Account* page lets you add, edit, or delete users and change the password for accessing the VM1600's GUI.

Note: This is an Administrator only function.

User Name	Level	Description
administrator	Administrator	Default_User
user_1	Basic User	User_Account

- ◆ **Add account** – Click the *Add account* button to add another user to the list. The VM1600 supports up to 32 users at one time (see page 85 for more details).
- ◆ **Edit** – Click the *Edit* button to change user information. This option allows an Administrator to edit individual accounts.

User Name	Level	Description	
Edit 111111	Administrator	111111	
Edit 12345	Administrator		
Edit administrator	Administrator	Default_user	

- ◆ **Edit** – Rename the user account, set the password, add a description, and set the user's permission level (see page 87 for more details).
- ◆ **Delete** – Removes the user account.



- ◆ The default username and password are: administrator/password.

Add Account

Use the Add Account / Edit buttons to create a user account, set the user's password, add a description, and set the user's permission level (see , page 86) when accessing the VM1600's GUI.

The screenshot shows a web form titled "Add account" with a green header. The form contains the following elements:

- Username:** A text input field.
- Password:** A text input field.
- Confirm Password:** A text input field.
- Description:** A text input field with a note below it: "Please enter 5-16 characters without '+@#[]:;''>?|\) space &".
- Permission Level:** Three radio button options:
 - Administrator Connections, Open/Save Profiles, Manage users
 - Advanced User Connections, Open/Save Profiles
 - Basic User Connections, Open Profiles
- Buttons:** "Create User" and "Cancel" buttons at the bottom.

- ◆ Fill in a username or edit an existing one.
- ◆ Enter a password and re-type the password to confirm.

Note: Usernames and passwords accept multi-lingual characters, and must be 5–16 alphanumeric characters (excluding ;=[]+=/?\|). Passwords are case sensitive. Usernames only support lower case letters.

- ◆ Add or edit the description for the user.
- ◆ Select the permission level that you want to grant the user (see , page 86).
- ◆ Click **Create User** to save the data.
- ◆ Click **Cancel** to discard the changes and exit.
- ◆ If a user is logged into the VM1600's GUI, their user settings cannot be edited, and the fields in this screen are grayed out.

Permission Level

At the bottom of the New/Edit User page is the permission section, which is used to set a user's permission level.

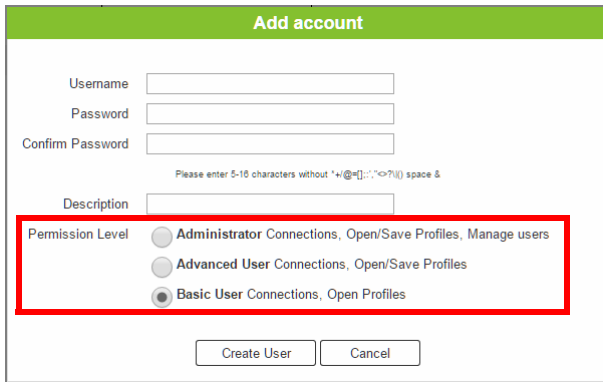

The screenshot shows a web form titled "Add account" with a green header. The form contains several input fields: "Username", "Password", "Confirm Password", and "Description". Below these fields is a "Permission Level" section with three radio button options. The "Basic User" option is selected. A red rectangular box highlights the "Permission Level" section. At the bottom of the form are two buttons: "Create User" and "Cancel".

Username

Password

Confirm Password

Please enter 5-16 characters without *+!@#%&'()*~=:;:~>?|) space &

Description

Permission Level

- Administrator Connections, Open/Save Profiles, Manage users
- Advanced User Connections, Open/Save Profiles
- Basic User Connections, Open Profiles

Create User Cancel

The three available permission levels are as follows:

- ◆ **Administrator** – this level provides full access and control of the VM1600, in addition to full User Management privileges.
- ◆ **Advanced User** – this level provides full access and control with no User Management privileges.
- ◆ **Basic User** – this level only provides basic functions (connections and open profiles).

Port Name

The *Annotation* page lets users name the Input and Output ports for easy identification.

Output Port	
Port1	01_Port_Out_1
Port2	02_Port_Out_2
Port3	03_Port_Out_3
Port4	04_Port_Out_4
Port5	05_Port_Out_5
Port6	06_Port_Out_6
Port7	07_Port_Out_7
Port8	08_Port_Out_8
Port9	09_Port_Out_9
Port10	10_Port_Out_10
Port11	11_Port_Out_11
Port12	12_Port_Out_12
Port13	13_Port_Out_13
Port14	14_Port_Out_14
Port15	15_Port_Out_15
Port16	16_Port_Out_16

Input Port	
Port1	01_Port_In_1
Port2	02_Port_In_2
Port3	03_Port_In_3
Port4	04_Port_In_4
Port5	05_Port_In_5
Port6	06_Port_In_6
Port7	07_Port_In_7
Port8	08_Port_In_8
Port9	09_Port_In_9
Port10	10_Port_In_10
Port11	11_Port_In_11
Port12	12_Port_In_12
Port13	13_Port_In_13
Port14	14_Port_In_14
Port15	15_Port_In_15
Port16	16_Port_In_16

- ◆ To name an Input/Output port, enter a descriptive name of up to 16 characters (including 0-9, a-z, A-Z, _, -) in the corresponding field.
- ◆ To change an Input/Output port's name, enter another value and click **Save**.
- ◆ Click **Reset** to clear all stored names.

Note: The Input and Output port names can be the same.

Network

The *Network* page lets you configure the VM1600's IP settings for connecting to it via the web GUI, and enable/disable Telnet.

DHCP	<input type="radio"/> Enable	<input checked="" type="radio"/> Disable
IP Address	<input type="text"/>	
Subnet Mask	<input type="text"/>	
Default Gateway	<input type="text"/>	
Website Timeout	5 min ▾	
MAC Address	00:10:74:AE:01:70	
Telnet	<input checked="" type="radio"/> Enable	<input type="radio"/> Disable

Enable DHCP to allow the DHCP server to assign an IP address to the VM1600. Select **Disable** to enter your own static IP address settings for the device.

Click **Reset** to use the following default values:

- ◆ IP Address – **192.168.0.60**
- ◆ Subnet Mask – **255.255.255.0**
- ◆ Default Gateway – **192.168.0.1**
- ◆ Website Timeout* – N/A, 5, 10, 30, 60 minutes
- ◆ Telnet Configuration enabled (checked)

Enter the values, then click **Save**. Changes may take a few seconds and after refreshing the page automatically redirects you to the IP address specified.

* This option controls how long an inactive web connection stays logged into the VM1600. Any changes will take effect immediately. The default setting is 5 minutes.

EDID Settings

The *EDID Setting* page lets users view and select an EDID Mode so that the VM1600 can use the best resolution for its display(s).

The screenshot displays the EDID Settings interface, which is divided into three main sections:

- EDID Mode:** This section contains four radio button options: **ATEN Default** (selected), **Port 1 Mode**, **Remix**, and **Customized**. Below these options is an **Apply** button and a **Port EDID Status** section. The status section lists eight ports, all of which are currently set to **ATEN Default**.
- EDID & CEA Description:** This section is split into two columns. The left column lists the **EDID** fields: 1. Vendor/Product Identification (highlighted), 2. EDID Structure/Revision, 3. Basic Display/Feature, 4. Color Characteristics, 5. Established Timings, 6. Standard Timings, 7. Detail Timing/Display Description 1, 8. Detail Timing/Display Description 2, 9. Monitor Description, and 10. Monitor Description. The right column lists the **CEA** fields: 1. Display Support, 2. Video Data, 3. Audio Data, 4. Speaker Allocation, 5. Vendor Specific Data, 6. Detail Timing/Display Description 1, 7. Detail Timing/Display Description 2, 6. Detail Timing/Display Description 3, 7. Detail Timing/Display Description 4, and 6. Detail Timing/Display Description 5.
- Metadata:** On the right side of the EDID & CEA Description section, there is a block of text providing specific details: **Model ID: 0x7801**, **Manufacturer ID: CMO**, **Serial Number: 0x00000000**, **Manufacture Date: 2005 Week 13**, **Week of Manufacture: 13**, and **Year of Manufacture: 2005**.

Note: The EDID Mode can also be selected via the Front Panel pushbuttons – see *Operation Mode*, page 45.

Extended Display Identification Data (EDID) is a data format that contains a display's basic information and is used to communicate with the video source/system.

EDID Mode

In the left panel of the page, users can select a pre-configured EDID Mode using the **EDID Mode** radio buttons.

EDID Mode

ATEN Default
 Port1 Mode
 Remix
 Customized

Port EDID Status

Port	EDID Status
Port 1	ATEN Default
Port 2	ATEN Default
Port 3	ATEN Default
Port 4	ATEN Default
Port 5	ATEN Default
Port 6	ATEN Default
Port 7	ATEN Default
Port 8	ATEN Default

EDID & CEA Description

EDID

1. Vendor/Product Identification
2. EDID Structure/Revision
3. Basic Display/Feature
4. Color Characteristics
5. Established Timings
6. Standard Timings
7. Detail Timing/Display Description 1
8. Detail Timing/Display Description 2
9. Monitor Description
10. Monitor Description

CEA

1. Display Support
2. Video Data
3. Audio Data
4. Speaker Allocation
5. Vendor Specific Data
6. Detail Timing/Display Description 1
7. Detail Timing/Display Description 2
6. Detail Timing/Display Description 3
7. Detail Timing/Display Description 4
6. Detail Timing/Display Description 5

Model ID: 0x7801
 Manufacturer ID: CMO
 Serial Number: 0x00000000
 Manufacture Date: 2005 Week 13
 Week of Manufacture: 13
 Year of Manufacture: 2005

Select the EDID Mode to use and click **Apply**. The VM1600 uses the settings configured for that EDID mode.

Options are:

- ◆ **ATEN Default:** All ports' EDID are the same as the hardware default EDID.
- ◆ **Port 1 Mode:** All ports' EDID are the same as Port 1's EDID.
- ◆ **Remix:** All ports' EDID use the best display resolution.
- ◆ **Customized:** See Customized Mode, see page 93.

EDID & CEA Description

The right panel of the screen lets users view the configuration of the *EDID* and *CEA* Modes selected:

EDID Mode

ATEN Default
 Port1 Mode
 Remix
 Customized

Apply

Port EDID Status

Port 1 ATEN Default
 Port 2 ATEN Default
 Port 3 ATEN Default
 Port 4 ATEN Default
 Port 5 ATEN Default
 Port 6 ATEN Default
 Port 7 ATEN Default
 Port 8 ATEN Default

EDID & CEA Description

EDID

1. Vendor/Product Identification
2. EDID Structure/Revision
3. Basic Display/Feature
4. Color Characteristics
5. Established Timings
6. Standard Timings
7. Detail Timing/Display Description 1
8. Detail Timing/Display Description 2
9. Monitor Description
10. Monitor Description

CEA

1. Display Support
2. Video Data
3. Audio Data
4. Speaker Allocation
5. Vendor Specific Data
6. Detail Timing/Display Description 1
7. Detail Timing/Display Description 2
6. Detail Timing/Display Description 3
7. Detail Timing/Display Description 4
6. Detail Timing/Display Description 5

Model ID: 0x7801
 Manufacturer ID: CMO
 Serial Number: 0x00000000
 Manufacture Date: 2005 Week 13
 Week of Manufacture: 13
 Year of Manufacture: 2005

- ◆ From the left column, click the option that you want to view and/or edit. There are two categories: **EDID** (Extended Display Identification Data) and **CEA** (Consumer Electronics Association).
- ◆ When you highlight the menu items on the left column, the right column displays the current settings for the corresponding EDID configuration. Some of the screens are read-only.
- ◆ See *EDID Settings*, page 90 for more information on these two columns.

Customized Mode

Use the *Customized* Mode to automatically retrieve and save the EDID settings of a connected monitor/display device to an input source port.

- ◆ In the left-most panel of the page, select **Customized** from the *EDID Mode* section and click **Apply**.
- ◆ **Port EDID Status**: Select which input source port you want to store the EDID configuration (01–16).
- ◆ **Retrieve EDID**: Click and a pop-up window appears to retrieve the EDID settings of a stored EDID configuration: *Customized EDID 01-16, Display Port* or *ATEN Default*. Select the port to retrieve:

Caution

Select a port to retrieve.

- ◆ The right panel displays a summary of the acquired EDID settings that you can edit. Click **Save** and select the configuration for the **Current Port** or **All Ports** for the duration of the session.

Save

Save changes to the current port or all ports?

Customized EDID Parameters

The EDID structure is comprised of 128 bytes in total – each heading shown in the left column corresponds to a specific number of bytes.

The pages for the pre-configured EDID Modes (Port 1, Default and Remix) cannot be edited. The pages for the Customized EDID, which can be edited, are discussed in the proceeding sections:

Established Timings

This page lists video resolutions/timings that display devices can support.

The screenshot shows the EDID configuration interface. On the left, the 'EDID Mode' sidebar has 'Customized' selected. The main area is titled 'EDID & CEA Description' and contains a list of sections: EDID (1-10) and CEA (1-10). The 'Established Timings' section (EDID 5) is expanded, showing a list of video resolutions and refresh rates. A red box highlights this list, which includes:

- 720x400 @ 70Hz
- 720x400 @ 88Hz
- 640x480 @ 60Hz
- 640x480 @ 67Hz
- 640x480 @ 72Hz
- 640x480 @ 75Hz
- 800x600 @ 56Hz
- 800x600 @ 60Hz
- 800x600 @ 72Hz
- 800x600 @ 75Hz
- 832x624 @ 75Hz (Apple Macintosh II)
- 1024x768 @ 87Hz, interlaced(1024*768)
- 1024x768 @ 60Hz
- 1024x768 @ 70Hz
- 1024x768 @ 75Hz
- 1280x1024 @ 75Hz
- 1152x870 @ 75Hz(Apple Macintosh II)

Buttons for 'Retrieve EDID', 'Save', 'Clear', and 'Select All' are visible at the bottom of the list.

- ◆ Select the resolution(s) you want to use for the attached monitor/ display device.
- ◆ Click **Clear All** to deselect all the items.
- ◆ Click **Select All** to check all the items.
- ◆ Click **Save** to apply the changes.

Standard Timings

This page shows eight resolutions/timings that display devices can support in addition to those listed in the Established Timings page.

EDID Mode: ATEN Default Port1 Mode Remix Customized

Port EDID Status: Port 1 Customized, Port 2 Customized, Port 3 Customized, Port 4 Customized, Port 5 Customized, Port 6 Customized, Port 7 Customized, Port 8 Customized

EDID & CEA Description: Retrieve EDID, Save

EDID

H Active Pixel	V Active Pixel	R Refresh Rate	Aspect Ratio
H 256	V 160	R 61	16:10
H 256	V 160	R 61	16:10
H 256	V 160	R 61	16:10
H 256	V 160	R 61	16:10
H 256	V 160	R 61	16:10
H 256	V 160	R 61	16:10
H 256	V 160	R 61	16:10
H 256	V 160	R 61	16:10

CEA

1. Display Support
2. Video Data
3. Audio Data
4. Speaker Allocation
5. Vendor Specific Data
6. Detail Timing/Display Description 1
7. Detail Timing/Display Description 2
8. Detail Timing/Display Description 3
9. Detail Timing/Display Description 4
10. Detail Timing/Display Description 5

- ◆ Select the *H Active Pixel* from the drop-down menu.
- ◆ Select the *Aspect Ratio* from the drop-down menu.
- ◆ Click **Save** to apply the changes.

Detail Timing / Display Description

This screen gives more video resolution options, and provides resolution/timing details.

EDID Mode: ATEN Default Port1 Mode Remix Customized

Port EDID Status: Port 1 Customized, Port 2 Customized, Port 3 Customized, Port 4 Customized, Port 5 Customized, Port 6 Customized, Port 7 Customized, Port 8 Customized

EDID & CEA Description: Retrieve EDID, Save

EDID

Resolution: [Dropdown Menu]

Stereo Display
Interlaced: Non-interlaced
Stereo Mode: none
Sync type: Digital Separate
Positive Vsync Polarity: yes
Positive Hsync Polarity: yes

Resolution Detail

	Horizontal	Vertical
Image Size :	mm	mm
Active PXL :	pixel	lines
Blanking Time :	pixel	lines
Sync Offset :	pixel	lines
Sync Width :	pixel	lines
Border :	pixel	lines

CEA

1. Display Support
2. Video Data
3. Audio Data
4. Speaker Allocation
5. Vendor Specific Data
6. Detail Timing/Display Description 1
7. Detail Timing/Display Description 2
8. Detail Timing/Display Description 3
9. Detail Timing/Display Description 4
10. Detail Timing/Display Description 5

In the drop down menu, choose a resolution with values that fit the attached monitor/display device and click Save.

Monitor Description

This screen lets you specify the viewing specifications, namely horizontal and vertical scan ranges and pixel clock rate, of your monitor/display device.

EDID Mode

ATEN Default

Port1 Mode

Remix

Customized

Port EDID Status

Port 1 Customized

Port 2 Customized

Port 3 Customized

Port 4 Customized

Port 5 Customized

Port 6 Customized

Port 7 Customized

Port 8 Customized

EDID & CEA Description

	Minutes	~	Max
Horizontal Scan Range:	15	~	102
Vertical Scan Range:	23	~	121
Pixel Clock Rate: (MHz)	80		(10~2550)

EDID

1. Vendor/Product Identification
2. EDID Structure/Revision
3. Basic Display/Feature
4. Color Characteristics
5. Established Timings
6. Standard Timings
7. Detail Timing/Display Description 1
8. Detail Timing/Display Description 2
9. Monitor Description
10. Monitor Description

CEA

1. Display Support
2. Video Data
3. Audio Data
4. Speaker Allocation
5. Vendor Specific Data
6. Detail Timing/Display Description 1
7. Detail Timing/Display Description 2
8. Detail Timing/Display Description 3
9. Detail Timing/Display Description 4
10. Detail Timing/Display Description 5

Enter the values that correspond to your device and click **Save** to apply the changes.

CEA Settings

CEA is an extension data of the EDID structure, which further extends the standard definitions of EDID to support advanced features of monitors/display devices.

Display Support

This screen describes the display's basic digital components.

EDID Mode

EDID & CEA Description

Retrieve EDID

Save

EDID Mode

- ATEN Default
- Port1 Mode
- Remix
- Customized

Apply

Port EDID Status

- Port 1 Customized
- Port 2 Customized
- Port 3 Customized
- Port 4 Customized
- Port 5 Customized
- Port 6 Customized
- Port 7 Customized
- Port 8 Customized

EDID

1. Vendor/Product Identification
2. EDID Structure/Revision
3. Basic Display/Feature
4. Color Characteristics
5. Established Timings
6. Standard Timings
7. Detail Timing/Display Description 1
8. Detail Timing/Display Description 2
9. Monitor Description
10. Monitor Description

Revision: 0x03

Underscan: no

Basic Audio: yes

YCbCr: YCbCr444

YCbCr422

CEA

1. Display Support
2. Video Data
3. Audio Data
4. Speaker Allocation
5. Vendor Specific Data
6. Detail Timing/Display Description 1
7. Detail Timing/Display Description 2
8. Detail Timing/Display Description 3
9. Detail Timing/Display Description 4
10. Detail Timing/Display Description 5

Select the YCbCr mode applicable to your display and click **Save**.

Video Data

This screen lists additional video resolution/timing displays that may be supported by other devices, other than PC monitors (for example, 1080i).

The screenshot shows the EDID configuration interface. On the left, under 'EDID Mode', 'Customized' is selected. The 'EDID & CEA Description' section is expanded to 'Video Data'. The 'Resolution' section is highlighted with a red box, showing a list of resolution options with checkboxes. The 'Native' resolution is set to '1280 x 720p @ 59.94/60Hz 16:9'. The 'Data Block Size' is set to 10.

EDID Mode

- ATEN Default
- Port1 Mode
- Remix
- Customized

Apply

Port EDID Status

Port 1 Customized

Port 2 Customized

Port 3 Customized

Port 4 Customized

Port 5 Customized

Port 6 Customized

Port 7 Customized

Port 8 Customized

EDID & CEA Description

Retrieve EDID Save

EDID

- Vendor/Product Identification
- EDID Structure/Revision
- Basic Display/Feature
- Color Characteristics
- Established Timings
- Standard Timings
- Detail Timing/Display Description 1
- Detail Timing/Display Description 2
- Monitor Description
- Monitor Description

CEA

- Display Support
- Video Data
- Audio Data
- Speaker Allocation
- Vendor Specific Data
- Detail Timing/Display Description 1
- Detail Timing/Display Description 2
- Detail Timing/Display Description 3
- Detail Timing/Display Description 4
- Detail Timing/Display Description 5

Native: 1280 x 720p @ 59.94/60Hz 16:9

Resolution:

Multiple selection(maximum 18)items

<input checked="" type="checkbox"/>	640 x 480p @ 59.94/60Hz 4:3
<input checked="" type="checkbox"/>	720 x 480p @ 59.94/60Hz 4:3
<input checked="" type="checkbox"/>	720 x 480p @ 59.94/60Hz 16:9
<input checked="" type="checkbox"/>	1280 x 720p @ 59.94/60Hz 16:9
<input checked="" type="checkbox"/>	1920 x 1080i @ 59.94/60Hz 16:9
<input type="checkbox"/>	720(1440) x 480i @ 59.94/60Hz 4:3
<input type="checkbox"/>	720(1440) x 480i @ 59.94/60Hz 16:9
<input type="checkbox"/>	720(1440) x 240p @ 59.94/60Hz 4:3
<input type="checkbox"/>	720(1440) x 240p @ 59.94/60Hz 16:9
<input type="checkbox"/>	2880 x 480i @ 59.94/60Hz 4:3
<input type="checkbox"/>	2880 x 480i @ 59.94/60Hz 16:9

Data Block Size:10 Clear

- ◆ Select the native resolution of the attached display device.
- ◆ Select the resolutions that work with the attached monitor/display device.
- ◆ Click **Clear All** to deselect all the items.
- ◆ Click **Save** to apply the changes.

Audio Data

This screen lets you select advanced audio configurations for your device.

The screenshot shows the 'Audio Data' configuration interface. On the left, under 'EDID Mode', the 'Customized' option is selected for 'Port 1'. The main area is titled 'EDID & CEA Description' and contains two sections: 'EDID' and 'CEA'. The 'EDID' section lists 10 items, and the 'CEA' section lists 9 items. On the right, there are 'Retrieve EDID' and 'Save' buttons. A red box highlights the 'Audio Format 1' dropdown menu, which is currently set to 'Linear PCM 2-channel'. Below it are dropdown menus for 'Audio Format 2' through 'Audio Format 6', all of which are currently empty.

Use the drop down menu to select the **Audio Format** (1~6) applicable to your audio output device, and click **Save** to apply the changes.

Detail Timing / Display Description

This screen gives more video resolution options, and provides resolution/timing details (in addition to those specified in the EDID structure).

The screenshot shows the 'Detail Timing / Display Description' configuration interface. The layout is similar to the 'Audio Data' screen, with 'EDID Mode' on the left and 'EDID & CEA Description' in the center. The 'Customized' option is selected for 'Port 1'. The 'EDID' section lists 10 items, and the 'CEA' section lists 9 items. On the right, there are 'Retrieve EDID' and 'Save' buttons. A red box highlights the 'Resolution' dropdown menu, which is currently set to '148.50'. Below this, there are sections for 'Stereo Display' and 'Resolution Detail'. The 'Resolution Detail' section contains a table with the following data:

	Horizontal	Vertical
Image Size:	mm	mm
Active PXL:	pixel	lines
Blanking Time:	pixel	lines
Sync Offset:	pixel	lines
Sync Width:	pixel	lines
Border:	pixel	lines

In the **Resolution** drop down menu, choose a resolution with values that fit the attached monitor/display device and click **Save**.

Maintenance

The *Maintenance* page lets users upgrade the VM1600's firmware and back up or restore system settings. This is an Administrator only function.

Firmware upgrade

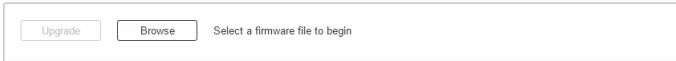

Backup / Restore

*User accounts cannot be backed up or restored.

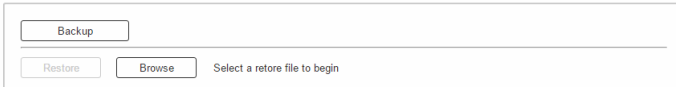

To upgrade the VM1600's firmware, do the following:

1. Use the **Browse** button to locate the firmware upgrade file. Make sure you have the correct file saved on your PC.
2. Click **Upgrade** to begin the upgrade procedure.

Note: After updating the firmware, it's recommended that you clear your web browser's cache and then close and reopen the web browser. This will ensure the GUI refreshes and functions properly.

To back up the VM1600's system settings, do the following:

1. Click **Backup**. A configuration file will then begin downloading.

To restore the VM1600's system settings, do the following:

1. Use the **Browse** button to locate the configuration file. Make sure you have the correct file saved on your PC.
2. Click **Restore** to begin the restoration procedure.

Note: User accounts cannot be backed up or restored.

VE805R Firmware Upgrade

To upgrade the VE805R from a computer, do the following:

1. Download the firmware upgrade package from the ATEN website.
2. Connect a computer to the VE805R's RS-232 port.

3. Power on the VE805R and turn its Firmware Upgrade switch to ON.
4. Reset the VE805R's power to enter firmware upgrade mode. The HDMI Out LED blinks orange every second to indicate the device is in F/W upgrade mode.
5. At this point you can run the firmware upgrade package from the computer connected to the VE805R.

IR/RS232 Channel

The *IR/RS232 Channel* page is available for VM7514 and VM8514 boards only. The options allow you to set ports to use **Local IR/RS232** which will direct the board to use the local IR and RS232 port signals, or **HDBaseT IR/RS232** which will direct the board to use the HDBaseT port for the IR and RS232 signals for control.

Use **Loopback** for the IR/RS232 signals to be sent back to local source or local display device connected to the same port on the same I/O board. This allows you to use the IR/RS232 connection to control devices locally. Loopback prevents the IR/RS232 signals from being sent across the connection to another I/O board. The Loopback setting is good when you use a VM8514 board to extend displays but use a different board type (not VM7514) for input devices and want to use the IR/RS232 signals for local control.

IR/RS232 Channel

RS232 Return Path Connection Path

In-Board		Connection	Out-Board	
Port	Apply to All	Follow Video Path	Port	Apply to All
Port 1	Local IR/RS232		Port 1	Local IR/RS232
Port 2	Local IR/RS232		Port 2	Local IR/RS232
Port 3	Local IR/RS232		Port 3	Local IR/RS232
Port 4	Local IR/RS232		Port 4	Local IR/RS232
Port 5	Local IR/RS232		Port 5	Local IR/RS232
Port 6	Local IR/RS232		Port 6	Local IR/RS232
Port 7	Local IR/RS232		Port 7	Local IR/RS232
Port 8	Local IR/RS232		Port 8	Local IR/RS232
Port 9	Local IR/RS232		Port 9	Local IR/RS232
Port 10	Local IR/RS232		Port 10	Local IR/RS232
Port 11	Local IR/RS232		Port 11	Local IR/RS232
Port 12	Local IR/RS232		Port 12	Local IR/RS232
Port 13	Local IR/RS232		Port 13	Local IR/RS232
Port 14	Local IR/RS232		Port 14	Local IR/RS232
Port 15	Local IR/RS232		Port 15	Local IR/RS232
Port 16	Local IR/RS232		Port 16	Local IR/RS232

Save Reset

- ◆ **In-Board:** Set each input port to use the *Local IR/RS232*, *HDBaseT IR/RS232*, or *Loopback* setting for the IR/RS232 signals.
 - ◆ Use the drop-down menu to apply an option to all ports; or select *Local IR/RS232*, *HDBaseT IR/RS232* or *Loopback* for individual ports.
- ◆ **Connection:** Sets the connection path for the IR/RS232 signals.
 - ◆ Use the drop-down menu to select *Follow Video Path* to have the IR/RS232 signal use the same connection path as the profile settings.

- ◆ Use the drop-down menu to select *Broadcast (I-All)* to broadcast the IR/RS232 signal from one port to all ports. Use the drop-down menu that appears to select the port that broadcasts the IR/RS232 signal.
- ◆ **Out-Board:** Set each output port to use the *Local IR/RS232*, *HDBaseT IR/RS232*, or *Loopback* setting for the IR/RS232 signals.
 - ◆ Use the drop-down menu to apply an option to all ports; or select *Local IR/RS232*, *HDBaseT IR/RS232* or *Loopback* for individual ports.

Click **Save** to save the settings. Click **Reset** to revert to the default settings.

Note: By default the RS232 Return Path will use the lowest port number available for a connection. This setting can not be changed.

HDPC

The *HDPC* page lets users view and set HDPC key settings between input and output ports for digital copy protection and to ensure Seamless Switching between different devices. This is an Administrator and Advanced User only function.

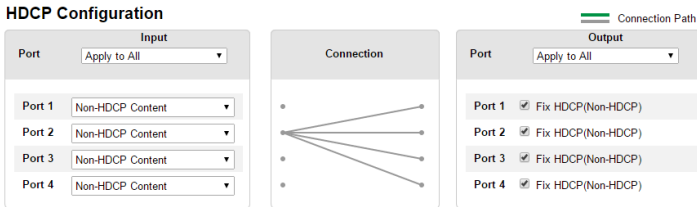

Input

Here users can select whether port content is HDCP 1.4 or non-HDCP enabled, either individually or by applying one setting to all ports.

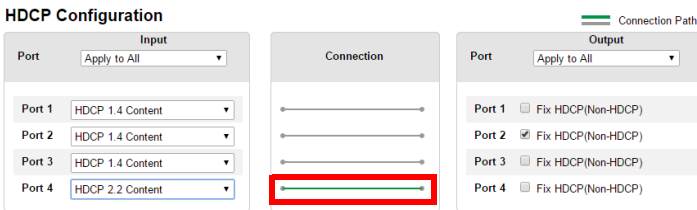

Connection

Here users can find a visual display of connection paths between inputs and outputs. When selecting an input, its path is displayed in green.

Output

Here users can define whether or not HDPC settings are fixed, either by individual port or by applying one setting to all ports. By prearranging and fixing keys, this setting ensures that Seamless Switching is possible even when switching between HDCP and non-HDCP enabled devices.

OSD/CEC

The OSD/CEC page lets users view and set OSD and CEC settings for all ports.

OSD / CEC		
Port	OSD	CEC
	Apply to All ▾	Apply to All ▾
Port1	<input checked="" type="checkbox"/> ON	<input type="checkbox"/> OFF
Port2	<input checked="" type="checkbox"/> ON	<input type="checkbox"/> OFF
Port3	<input checked="" type="checkbox"/> ON	<input type="checkbox"/> OFF
Port4	<input checked="" type="checkbox"/> ON	<input type="checkbox"/> OFF

- ◆ **OSD:** Sets the default OSD option for the port. When OSD is on, real-time text updates appear on the display for 10 seconds when configuration and port changes are made to its output.
 - ◆ Use the drop-down menu to apply options to all ports, or ON/OFF button to enable/disable the OSD for each port.
- ◆ **CEC:** Consumer Electronics Control (CEC) allows interconnected HDMI devices to communicate and respond to one remote control.
 - ◆ Use the drop-down menu to apply options to all ports, or On/Off button to enable/disable CEC for a port.
- ◆ Click **Save** to save the settings or **Cancel** to exit without saving the settings.

Telnet Operation

The VM1600 can be operated and configured via a remote terminal session using Telnet.

To log into the VM1600 by means of a Telnet session, do the following:

1. On your computer, open a terminal (command line) session.
2. At the prompt, key in the VM1600's IP address in the following way:

```
telnet [IP address]:23
```
3. Press **Enter**. The login screen appears. At the login prompt, provide your Username and Password.

Note: If a user logs on using a Username that is already in session, the newest login takes effect and the previous session is replaced.

Configuration Menu

Once a Telnet connection to the VM1600 is established, the device's text-based Configuration Menu comes up, with the following items:

1. H – Call up the command list for help

Command list:

IP – Set IP address

LO – Load connections from profile *nn*

PW – Change password

RI – Read what input is connected to *nn* output

RO – Read what output is connected to *nn* input

SB – Set the serial port baud rate

SS – Switch input to specified port

SV – Save the current connections into profile *nn*

TI – Set timeout

VR – Software version information

Ctrl-Q – Quit

2. IP – Set IP address

IP

Old IP address: 192.168.0.60

New IP address:

3. LO – Load connections from profile

LO 01

Load profile 01 OK.

4. PW – Change password

PW

Old password: *****

New password:

5. RI – Read what input is connected to *nn* output

RI 01

Input port 02 04 08 is connected to output port 01

6. RO – Read what output is connected to *nn* input

RO 01

Output port 02 is connected to input port 01

7. SB – Set serial port baud rate

SB 96

Serial port baud rate is set to 9600

8. SS – Switch input to specified output

SS 01,03

Switch input 01 to output 03 (00: Local Port)

9. SV – Save the current connections into a profile

SV 01

Save the current connections into profile 01

10. TI – Set timeout

TI 30

Set 30 minute timeout

11. VR – Software version information

VR

Software version 1.0.

Note: For further information about these functions, please reference the equivalent Browser GUI functions earlier in this chapter.

Chapter 5

RS-232 Commands

Serial Control Protocol Commands

The VM1600's built-in bi-directional RS-232 serial interface allows system control through a high-end controller or PC.

RS232 Pin Assignment

Pin	Description	Pin	Description
1	Not connected	6	Not connected
2	RXD	7	Not connected
3	TXD	8	Not connected
4	Not connected	9	Not connected
5	GND		

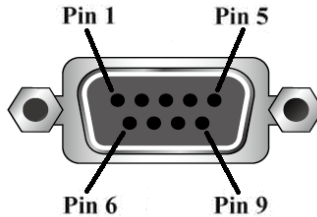

Configuring the Serial Port

The controller's serial port should be configured as follows:

Baud Rate	19200
Data Bits	8
Parity	None
Stop Bits	1
Flow Control	None

RS-422 / RS-485

In the sections that follow the formulas that include an “address” command are for RS-422 and RS-485 serial port devices when the VM1600 is setup in cascade installation.

Verification

After entering a command, a verification message appears at the end of the command line as follows:

- ♦ **Command OK** - indicates that the command is correct and successfully performed by the switch
- ♦ **Command incorrect** - indicates that the command has the wrong format and/or values.

Switch Port Command

The formula for Switch commands is as follows:

Switch Command + Input + Num1 + Output + Num2 + Address + Num3 + Control [Enter]

1. For example, to switch input port 02 to output port 05, type the following:
sw i02 o05 [Enter]
2. To switch output port 04 to the next port, input the following:
sw o04 + [Enter]
3. To turn off video output on port 03, type the following:
sw o03 off [Enter]
4. To turn off video output on port 03 on device 02, type the following:
sw o03 a02 off [Enter]

The following tables show the possible values for the **Switch Port** command

Command	Description
sw	Switch command
Input	Description
i	Input port command
Num1	Description
xx	Input port xx: 01~16
*	All input ports
Output	Description
o	Output port command
Num2	Description
yy	Output port yy: 01~16
*	All output ports
Address	Description
a	Device address command (RS-422 and RS-485 only)

Num3	Description
zz	Device address zz: 01~16 (default is 01) (RS-422 and RS-485 only)
*	All devices

Control	Description
on	Turn on the display
off	Turn off the display
+	Next Port
-	Previous Port

Note: By default, input port 01 is tied to output port 01; input port 02 is tied to output port 02; and so on until port 08 (i.e., o01 i01, o02 i02... o16 i16)

The following table shows the available command list:

Command	Input	Input Port	Output	Output Port	Address	Device No.	Control	Enter	Description
sw	i	xx *	o	yy *	a	zz *		[Enter]	Switch Input Port xx to Output Port yy on address zz xx:01~16, * yy:01~16, * zz: 01~16, *
sw			o	yy *	a	zz *	on off	[Enter]	Turn on Output Port yy Turn off Output Port yy on address zz yy:01~16, * zz: 01~16, *
sw			o	yy *	a	zz *	+ -	[Enter]	Switch Output port yy to next Output port / Switch Output port yy to previous Output port on address zz yy:01~16, * zz: 01~16, *

- Note:**
1. Each command string can be separated with a space.
 2. The **Address** command is for RS-422/485 only. If the address parameter is missing from RS-422/485 commands, the default **a00** will be used. Skip the address for RS-232 commands.

3. The **Port Number** and **Address** command strings can be skipped, and the default value will be used.
-

Mute Command

Mute allows you to enable or disable an output port(s) audio. The Mute command will turn on/off the HDMI audio and stereo audio. When the HDMI audio is off, the stereo's volume can be adjusted using the volume command.

The formula for the Mute command is as follows:

Command + Output + Num1 + Address + Num2 + Control + [Enter]

1. For example, to mute the audio on output port 03, type the following:
mute o03 on [Enter]
2. To turn mute off on all output ports, type the following:
mute o* off [Enter]
3. To mute the audio for output port 09 on device 03, type the following:
mute o09 a03 on [Enter]

The following tables show the possible values for the **Mute** command:

Command	Description
mute	Mute command

Output	Description
o	Output port command

Num1	Description
xx	Output port number xx: 01~16 (default is 01)
*	All output ports

Address	Description
a	Device address command (RS-422 and RS-485 only)

Num2	Description
zz	Device address zz: 01~16 (default is 01) (RS-422 and RS-485 only)
*	All devices

Control	Description
on	Mute on; audio on output port is disabled

Control	Description
off	Mute off; audio on output port is enabled (default)

- Note:**
1. Each command string can be separated with a space.
 2. The **Address** command is for RS-422/485 only. If the address parameter is missing from RS-422/485 commands, the default **a00** will be used. Skip the address for RS-232 commands.
 3. Skip the **Output** command to mute or enable the audio of all output ports.

The following table shows the available command list:

Command	Output	Num1	Address	Num2	Control	Enter	Description
mute	o	xx *	a	zz *	on	[Enter]	Mute audio for output port xx, on device zz xx:01~16, * zz: 01~16,*
mute	o	xx *	a	zz *	off	[Enter]	Turn mute off for output port xx, on device zz xx:01~16, * zz: 01~16,*

Volume Command

The volume command allows adjusts the stereo volume for an output port.

The formula for the Volume command is as follows:

Command + Output + Num1 + Address + Num2 + Volume + Control + [Enter]

1. For example, to adjust the volume for output port 06 to level 14, type the following:

volume o06 v14 [Enter]

2. To adjust the volume for all output ports to level 04, type the following:

volume o* v04 [Enter]

3. For example, to adjust the volume for output port 06 on device 01 to level 14, type the following:

volume o06 a01 v14 [Enter]

The following tables show the possible values for the **Volume** command:

Command	Description
volume	Volume command

Output	Description
o	Output port command

Num1	Description
xx	Output port xx: 01~16 (default is 01)
*	All output ports

Address	Description
a	Device address command (RS-422 and RS-485 only)

Num2	Description
yy	Device address yy: 01~16 (default is 01) (RS-422 and RS-485 only)
*	All devices

Volume	Description
v	Volume level command

Control	Description
zz	Audio volume level zz: 01~10 (default is 10)

- Note:** 1. Each command string can be separated with a space.
2. The **Address** command is for RS-422/485 only. If the address parameter is missing from RS-422/485 commands, the default **a00** will be used. Skip the address for RS-232 commands.

The following table shows the available command list:

Command	Out put	Num1	Address	Num2	Vol- ume	Control	Enter	Description
volume	o	xx *	a	yy *	v	zz	[Enter]	Adjust volume for output port xx, on device yy, to level zz xx:01~16,* yy: 01~16,* zz: 01~16,*

Save/Load Profile Commands

The Save/Load Profile command allows you to save the current connection configuration as a profile and load connection profiles.

The formula for Save/Load Profile commands is as follows:

Command + Profile + Num1 + Address + Num2 + Control + [Enter]

1. For example, to save the current connection configuration as profile 08, type the following:

profile f08 save [Enter]

2. To load connection profile 04, type the following:

profile f04 load [Enter]

3. To save the current connection configuration of device 03 as profile 08, type the following:

profile f08 a03 save [Enter]

The following tables show the possible values for commands:

Command	Description
profile	Save / Load Profile command

Profile	Description
f	Profile command

Num1	Description
xx	Profile number xx: 01-32 (default is 01)

Address	Description
a	Device address command (RS-422 and RS-485 only)

Num2	Description
yy	Device address yy: 01~16 (default is 01) (RS-422 and RS-485 only)
*	All devices

Control	Description
save	Save the current connection configuration

Control	Description
load	Load a saved profile

- Note:**
- Each command string can be separated with a space.
 - The **Address** command is for RS-422/485 only. If the address parameter is missing from RS-422/485 commands, the default **a00** will be used. Skip the address for RS-232 commands.
 - If the **Address** or **Profile** parameter is skipped the default value will be used.

The following table shows the available command list:

Command	Profile	Num1	Address	Num2	Control	Enter	Description
profile	f	xx	a	yy *	save	[Enter]	Save current connection configuration on device yy as profile xx xx:01~16 yy: 01~16,*
profile	f	xx	a	yy *	load	[Enter]	Load profile xx on device yy xx:01~16 yy: 01~16,*

EDID Mode Command

Extended Display Identification Data (EDID) is a data that contains a display's basic information and is used to communicate with the video source. The EDID Mode commands allow you to change the EDID setting.

The formula for the EDID command is as follows:

Command + Address + Number + Control + [Enter]

1. For example, for port 06 to use the remix EDID mode, type:

edid a06 remix [Enter]

1. For example, to use Port1 EDID mode for all devices, type:

2. **edid a* port1 [Enter]**

The following tables show the possible values for the **EDID** command:

Command	Description
edid	EDID command

Address	Description
a	Device address command (RS-422 and RS-485 only)

Number	Description
zz	Device address zz: 01~16 (default is 01) (RS-422 and RS-485 only)
*	All devices

Control	Description
port1	Implement the EDID of the connected display to Port 1, and pass it to the video source.
remix	Implement the EDID of each connected display according to its connection when the VM1600 is first powered on, or immediately after selecting the Remix option.
default	Implements ATEN's default EDID. (default)
custom	Implements the customized mode as set in the EDID system settings. (See <i>Customized Mode</i> , page 93)

-
- Note:** 1. Each command string can be separated with a space.
2. The **Address** command is for RS-422/485 only. If the address parameter is missing from RS-422/485 commands, the default **a00** will be used. Skip the address for RS-232 commands.
-

The following table lists the available EDID commands:

Command	Address	Num	Control	Enter	Description
edid	a	zz *	port1	[Enter]	The EDID from Port 1 is passed to the video source. zz: 01~16
edid	a	zz *	remix	[Enter]	The VM1600 implements the EDID of each connected display according to its connection when the device is first powered on, or immediately after selecting the Remix option.
edid	a	zz *	default	[Enter]	ATEN's default EDID is passed to the video source.
edid	a	zz *	custom	[Enter]	Implements the customized mode.

CEC Command

Consumer Electronics Control (CEC) allows interconnected HDMI devices to communicate and respond to the same remote control.

The formula for the CEC command is as follows:

Command + Output + Number + Control + [Enter]

1. For example, to enable the CEC function on output port 1, type:
cec o01 on [Enter]

The following tables show the possible values for the CEC command:

Command	Description
cec	CEC command
Output Command	Description
o	Output port command
Number	Description
yy	Output port 01~16 port (default is 01)
*	All output ports
Control	Description
off	Disable CEC (default)
on	Enable CEC

Note: Each command string can be separated with a space.

The following table lists the available CEC commands:

Command	Output Port	Control	Enter	Description
cec	yy *	off	[Enter]	CEC off for output port yy (default) (yy:01~16, *)
cec	yy *	on	[Enter]	CEC on for output port yy (yy:01~16, *)

Read Command

The Read command allows you to view information about the devices.

The formula for the Read command is as follows:

Command + Address + Number + [Enter]

- To view information, type:

read [Enter]

- To view information about device 02, type:

read a02 [Enter]

The following table shows the possible values for the **Read** command:

Command	Description
read	Read command
Address	Description
a	Device address command (RS-422 and RS-485 only)
Number	Description
zz	Device address zz: 01~16 (default is 01) (RS-422 and RS-485 only)
*	All Devices

Note: The **Address** command is for RS-422/485 only. If the address parameter is missing from RS-422/485 commands, the default **a00** will be used. Skip the address for RS-232 commands.

The following table lists the available Read commands:

Command	Address	Num	Enter	Description
read	a	zz *	[Enter]	View information about device number zz: 01~16

DVI/HDMI Example:

read Command OK

o01 i03 video on i06 audio v10 HDMI-A on 1080p

o02 i04 video off i06 audio off HDMI-A off bypass

o03 i02 video on i06 audio v10 HDMI-A off 1600

How to read the commands:

1. o01 i03 video on i06 audio v10 HDMI-a on 1080p

Output 01 is connected to **Input 03** with **video on**; **audio** is **on** from **Input 06** with **volume 10** using the **HDMI** audio source; the resolution is scaled to **1080p**

2. o01 i03 video on i06 audio v10 1080p

Output 01 is connected to **Input 03** with **video on**; **audio** is on with **volume 10**; the resolution is scaled to **1080p**

3. o02 i04 video off i06 audio off HDMI-a off bypass

Output 02 is connected to **Input 04** with **video off**; **audio** is **off** from **Input 06** using the **HDMI** audio source; scaling is **bypassed** (turned off)

Reset Command

The Reset command allows you to reset the VM1600 back to the default factory settings. Reset includes resetting the device's IP address.

The formula for the Reset command is as follows:

Command + Address + Number + [Enter]

- To reset the VM1600, type:

reset [Enter]

- To reset device 02, type:

reset a02 [Enter]

The following tables show the possible values for the **Reset** command:

Command	Description
reset	Reset command

Address	Description
a	Device address command (RS-422 and RS-485 only)

Device Number	Description
zz	Device address zz: 01~16 (default is 01) (RS-422 and RS-485 only)
*	All Devices

Note: 1. Each command string can be separated with a space.

- The **Address** command is for RS-422/485 only. If the address parameter is missing from RS-422/485 commands, the default **a00** will be used. Skip the address for RS-232 commands.

The following table lists the available Reset commands:

Command	Address	Num	Enter	Description
reset	a	zz *	[Enter]	Resets the device settings Address; zz: 01~16 (RS-422 and RS-485 only)

Baud Rate Command

The Baud Rate command allows you to set the RS-232 data rate for the VM1600 to use. Options are 9600, 19200 (default) 38400 and 115200.

The formula for the Baud Rate command is as follows:

Command + Control + [Enter]

1. For example, to set 38400 as the baud rate, type:

baud 38400 [Enter]

The following tables show the possible values for the **Baud Rate** command:

Command	Description
baud	Sets the RS-232 baud rate

Control	Description
9600	Use 9600 baud rate
19200	Use 19200 baud rate
38400	Use 38400 baud rate
115200	Use 115200 baud rate

Note: Each command string can be separated with a space.

The following table lists the available Baud Rate commands:

Command	Control	Enter	Description
baud	9600 / 19200 / 38400 / 115200	[Enter]	Sets the baud rate

OSD Command

To enable or disable the On-Screen Display (OSD) for displays, use the following command:

Command + Output + Number + Control + [Enter]

1. For example, to enable the OSD for output 07, type:
osd o07 on [Enter]
2. For example, to disable the OSD for all outputs, type:
osd o* off [Enter]

The following tables show the possible values for the **OSD** command:

Command	Description
osd	OSD command
Output	Description
o	Output port command
Number	Description
yy	Output port 01~16 port (default is 01)
*	All output ports
Control	Description
on	Enable OSD function
off	Disable OSD function (default)

Note: Each command string can be separated with a space.

The following table lists the available OSD commands:

Command	Output Port	Control	Enter	Description
osd	yy *	on	[Enter]	OSD on for output yy yy:01~16, *
osd	yy *	off	[Enter]	CEC off for output yy (default) yy:01~16, *

Echo Command

The Echo function updates the RS232 controller when operations are made via the front panel pushbuttons, web browser or telnet. The changes echo back to the RS232 controller to keep the settings in sync with the device.

The formula for the Echo command is as follows:

Command + Control + [Enter]

1. For example, to enable the echo feature, type:

echo on [Enter]

The following tables show the possible values for the **Echo** command:

Command	Description
echo	Echo command

Control	Description
on	Turns Echo function on
off	Turns Echo function off (default)

Note: Each command string can be separated with a space.

The following table lists the available Echo commands:

Command	Control	Enter	Description
echo	on	[Enter]	Turn on Echo function
echo	off	[Enter]	Turn off Echo function

Scaling Command

The Scaling command allows you to set a resolution for scaling the display connected to an output port.

The formula for the Scaling command is as follows:

Command + Output + Number 1 + Address + Number 2 + Horizontal Resolution + Number 3+ Vertical Resolution + Number 4 + Frequency + Number 5 + Control + [Enter]

1. For example, to turn scaling off for output port 02, type:
scaling o02 off [Enter]
2. To set the scaling for output port 04 to 1920x1080@60Hz, type:
scaling o04 1080p [Enter]
3. To set the scaling for all output ports on all devices to the connected display's native resolution, type:
scaling o* a* native [Enter]

The following tables show the possible values for the **Scaling** command:

Command	Description
scaling	Scaling command

Output	Description
o	Output command

Num1	Description
yy	Output port yy: 01~16 (default is 01)
*	All output ports

Address	Description
a	Device address command (RS-422 and RS-485 only)

Num2	Description
zz	Device Address zz: 01~16 (RS-422 and RS-485 only)
*	All Devices

Horizontal Resolution	Description
hor	Horizontal resolution command for scaling

Resolution Number	Description
hhhh	Horizontal resolution

Vertical Resolution	Description
ver	Vertical resolution command for scaling

Resolution Number	Description
vvvv	Vertical resolution

Frequency	Description
freq	Frequency command for scaling

Frequency Number	Description
fff	Frequency resolution

Horizontal Resolution	Description
hor	Horizontal resolution command for scaling

Control	Description
off	Turn off the scaling function (by pass mode)
native	Map display's native resolution for scaling (default)

-
- Note:** 1. Each command string can be separated with a space.
2. The **Address** command is for RS-422/485 only. If the address parameter is missing from RS-422/485 commands, the default **a00** will be used. Skip the address for RS-232 commands.

3. The **Port Number** command string can be skipped, and the default value will be used.

The following table lists the available Scaling commands:

Com	Out	N1	Add	N2	Horizontal Res	N3	Vertical Res	N4	Frequency	N5	Cont	Enter	Description
scaling	o	yy*	a	zz*	hor		ver		freq		off	[Enter]	Turn off scaling for output yy device zz (by pass mode) yy: 01~16 or * zz: 01~16 or *
scaling	o	yy*	a	zz*	hor		ver		freq		native	[Enter]	Enable display's native resolution for scaling on output yy device zz (default) yy: 01~16 or * zz: 01~16 or *
scaling	o	yy*	a	zz*	hor	1920	ver	1080	freq	60		[Enter]	Scale output yy device zz to 1920x1080@60Hz yy: 01~16 or * zz: 01~16 or *
scaling	o	yy*	a	zz*	hor	1280	ver	720	freq	60		[Enter]	Scale output yy device zz to 1280x720@60Hz yy: 01~16 or * zz: 01~16 or *

Com	Out	N1	Add	N2	Horizontal Res	N3	Vertical Res	N4	Frequency	N5	Cont	Enter	Description
scaling	o	yy*	a	zz*	hor	1920	ver	1200	freq	60		[Enter]	Scale output port yy device zz to 1920x1200@60Hz yy: 01~16 or * zz: 01~16 or *
scaling	o	yy*	a	zz*	hor	1600	ver	1200	freq	60		[Enter]	Scale output yy device zz to 1600x1200@60Hz yy: 01~16 or * zz: 01~16 or *
scaling	o	yy*	a	zz*	hor	1400	ver	1050	freq	60		[Enter]	Scale output yy device zz to 1400x1050@60Hz yy: 01~16 or * zz: 01~16 or *
scaling	o	yy*	a	zz*	hor	1280	ver	1024	freq	60		[Enter]	Scale output yy device zz to 1280x1024@60Hz yy: 01~16 or * zz: 01~16 or *
scaling	o	yy*	a	zz*	hor	1024	ver	768	freq	60		[Enter]	Scale output yy device zz to 1024x768@60Hz yy: 01~16 or * zz: 01~16 or *

Fan Speed Command

The Fan Speed command allows you to set the VM1600's internal fan speed.

To set the fan speed, use the following command:

Command + Control + [Enter]

1. For example, to set the fan to auto detect, type:

fan auto [Enter]

The following tables show the possible values for the **Fan Speed** command:

Command	Description
fan	Fan Speed Command

Control	Description
low	Set internal fan to low speed
mid	Set internal fan to normal speed
high	Set internal fan to high speed
auto	Set internal fan to auto detect (default)

Note: Each command string can be separated with a space.

The following table lists the available Fan Speed commands:

Command	Control	Enter	Description
fan	low	[Enter]	Sets fan speed to low
fan	mid	[Enter]	Sets fan speed to normal
fan	high	[Enter]	Sets fan speed to high
fan	auto	[Enter]	Sets fan speed to auto detect (default)

Alert Command

To trigger a warning when issues arise for a specific input port, use the following command:

Command + Input + Number + Control + [Enter]

1. For example, to enable the basic Alert function for input port 1, type:

alert i01 m1 [enter]

The following tables show the possible values for the **Alert** command:

Command	Description
alert	Alert command

Input	Description
i	Input command

Port number	Description
yy	01-04 port

Control	Description
off	Disable Alert (default)
m1	Show basic Alert (flashing border)
m2	Show detailed Alert (flashing border and port information)

Note: Each command string can be separated with a space.

The following table lists the available Alert commands:

Command	Input Command	Input Port	Control	Enter	Description
alert	i	yy	off	[Enter]	Alert off for input port yy (yy:01~04)
alert	i	yy	m1	[Enter]	Basic Alert on for input port yy (yy:01~04)
alert	i	yy	m2	[Enter]	Detailed Alert on for input port yy (yy:01~04)

Safety Instructions

General

- ◆ Read all of these instructions. Save them for future reference.
- ◆ Follow all warnings and instructions marked on the device.
- ◆ This product is for indoor use only.
- ◆ Do not place the device on any unstable surface (cart, stand, table, etc.). If the device falls, serious damage will result.
- ◆ Do not use the device near water.
- ◆ Do not place the device near, or over, radiators or heat registers.
- ◆ The device cabinet is provided with slots and openings to allow for adequate ventilation. To ensure reliable operation, and to protect against overheating, these openings must never be blocked or covered.
- ◆ The device should never be placed on a soft surface (bed, sofa, rug, etc.) as this will block its ventilation openings. Likewise, the device should not be placed in a built in enclosure unless adequate ventilation has been provided.
- ◆ Never spill liquid of any kind on the device.
- ◆ Unplug the device from the wall outlet before cleaning. Do not use liquid or aerosol cleaners. Use a damp cloth for cleaning.
- ◆ The device should be operated from the type of power source indicated on the marking label. If you are not sure of the type of power available, consult your dealer or local power company.
- ◆ The device is designed for IT power distribution systems with 230V phase-to-phase voltage.
- ◆ To prevent damage to your installation it is important that all devices are properly grounded.
- ◆ The device is equipped with a 3-wire grounding type plug. This is a safety feature. If you are unable to insert the plug into the outlet, contact your electrician to replace your obsolete outlet. Do not attempt to defeat the purpose of the grounding-type plug. Always follow your local/national wiring codes.
- ◆ Do not allow anything to rest on the power cord or cables. Route the power cord and cables so that they cannot be stepped on or tripped over.

- ◆ If an extension cord is used with this device make sure that the total of the ampere ratings of all products used on this cord does not exceed the extension cord ampere rating. Make sure that the total of all products plugged into the wall outlet does not exceed 15 amperes.
- ◆ To help protect your system from sudden, transient increases and decreases in electrical power, use a surge suppressor, line conditioner, or un-interruptible power supply (UPS).
- ◆ Position system cables and power cables carefully; Be sure that nothing rests on any cables.
- ◆ Never push objects of any kind into or through cabinet slots. They may touch dangerous voltage points or short out parts resulting in a risk of fire or electrical shock.
- ◆ Do not attempt to service the device yourself. Refer all servicing to qualified service personnel.
- ◆ If the following conditions occur, unplug the device from the wall outlet and bring it to qualified service personnel for repair.
 - ◆ The power cord or plug has become damaged or frayed.
 - ◆ Liquid has been spilled into the device.
 - ◆ The device has been exposed to rain or water.
 - ◆ The device has been dropped, or the cabinet has been damaged.
 - ◆ The device exhibits a distinct change in performance, indicating a need for service.
 - ◆ The device does not operate normally when the operating instructions are followed.
- ◆ Only adjust those controls that are covered in the operating instructions. Improper adjustment of other controls may result in damage that will require extensive work by a qualified technician to repair.
- ◆ Avoid circuit overloads. Before connecting equipment to a circuit, know the power supply's limit and never exceed it. Always review the electrical specifications of a circuit to ensure that you are not creating a dangerous condition or that one does not already exist. Circuit overloads can cause a fire and destroy equipment.

Rack Mounting

- ◆ Before working on the rack, make sure that the stabilizers are secured to the rack, extended to the floor, and that the full weight of the rack rests on the floor. Install front and side stabilizers on a single rack or front stabilizers for joined multiple racks before working on the rack.
- ◆ Always load the rack from the bottom up, and load the heaviest item in the rack first.
- ◆ Make sure that the rack is level and stable before extending a device from the rack.
- ◆ Do not overload the AC supply branch circuit that provides power to the rack. The total rack load should not exceed 80 percent of the branch circuit rating.
- ◆ Make sure that all equipment used on the rack – including power strips and other electrical connectors – is properly grounded.
- ◆ Ensure that proper airflow is provided to devices in the rack.
- ◆ Ensure that the operating ambient temperature of the rack environment does not exceed the maximum ambient temperature specified for the equipment by the manufacturer.
- ◆ Do not step on or stand on any device when servicing other devices in a rack.

Technical Support

International

- ◆ For online technical support – including troubleshooting, documentation, and software updates: <http://eservice.aten.com>
- ◆ For telephone support, see *Telephone Support*, page iii:

North America

Email Support		support@aten-usa.com
Online Technical Support	Troubleshooting Documentation Software Updates	http://www.aten-usa.com/support
Telephone Support		1-888-999-ATEN ext 4988

When you contact us, please have the following information ready beforehand:

- ◆ Product model number, serial number, and date of purchase.
- ◆ Your computer configuration, including operating system, revision level, expansion cards, and software.
- ◆ Any error messages displayed at the time the error occurred.
- ◆ The sequence of operations that led up to the error.
- ◆ Any other information you feel may be of help.

Specifications

VM1600

Function		VM1600
Video Input	Interface	Depends on which I/O board is inserted
	Impedance	100 Ω
	Maximum Data Rate	10.2 Gbps (3.4 Gbps per lane)
	Maximum Pixel Clock	340 MHz
	Compliance	HDMI (3D, Deep Color, 4K) HDCP 1.4 Compatible Consumer Electronics Control (CEC) HDBaseT Compatible
Audio	Input	Depends on which Input board is inserted
	Output	Depends on which Output board is inserted
Control	RS-232	Connector: 1 x DB-9 Female (Black) Serial Control Pin Configurations: Pin2 = Tx, Pin 3=Rx, Pin 5= Gnd Baud Rate and Protocol: Baud Rate:19200, Data Bits:8, Stop Bits:1, Parity: No, Flow Control: No
	RS-485/RS-422	Connector: 1 x Captive Screw Connector, 5 Pole
	Ethernet	Connector: 1 x RJ-45 Female
EDID Settings		EDID Mode: Default / Port1 / Remix / Customized (EDID Wizard support)
Power	Connectors	1 x 3-Prong AC Socket
	I/P Rating	100-240 VAC; 47-63 Hz; 8/4 A
	Consumption	120 VAC, 180W; 230 VAC,172W *A redundant power supply is optional.
Fan		Airflow: 60 cfm Operating Voltage: 10.8 - 13.8 VDC Operating Temp: -10–70°C
Environmental	Operating Temperature	0–40°C
	Storage Temperature	-20–60°C
	Humidity	0–80% RH, Non-condensing
Physical Properties	Housing	Metal
	Weight	17.00 kg (chassis only)
	Dimensions (L x W x H)	48.22 x 39.90 x 26.59 cm

VM7404

Function		VM7404
Video Input	Interface	4 x BNC Female
	Impedance	75 Ω
	Maximum Bandwidth	300 MHz
	Maximum Data Rate	2.97 GHz
	Maximum Resolution	1920 x 1080
	Maximum Distance	90 m (3G-SDI); 140 m (HD-SDI); 300 m (SD-SDI)
Audio	Interfaces	4 x Captive Screw Connectors, 5 pole
		Audio signal type*: stereo, balanced / unbalanced
Power	Consumption	16.0 W
Environmental	Operating Temperature	0–40°C
	Storage Temperature	-20–60°C
	Humidity	0–80% RH, Non-condensing
Physical Properties	Housing	Metal
	Weight	0.60 kg
	Dimensions (L x W x H)	35.20 x 24.28 x 2.28 cm

Note: Supported audio signal types: stereo, balanced, unbalanced.

Balanced audio maximum input/output level: 0.5 V_{rms} (-6.02 dBV @ 600 ohm)

Unbalanced audio maximum input/output level: 1 V_{rms} (0 dBV @ 600 ohm)

VM7514 / VM8514

Function		VM7514	VM8514
Connectors	HDBaseT In	4 x RJ-45 Female (Silver)	N/A
	HDBaseT Out	N/A	4 x RJ-45 Female (Silver)
	IR	4 x Mini Stereo Jack Female (Black)	4 x Mini Stereo Jack Female (Black)
	RS-232	4 x Captive Screw Connector, 3 pole	4 x captive screw connector, 3 pole
LED	Status	1 (Green)	1 (Green)
Power Consumption		24.5W	12.2W
Environment	Operating Temp.	0–40°C	
	Storage Temp.	-20–60°C	
	Humidity	0–80% RH, Non-condensing	
Physical Properties	Housing	Metal	
	Weight	0.64 kg	0.62 kg
	Dimensions (L x W x H)	35.20 x 23.70 x 2.25 cm	

VM7804 / VM8804

Function		VM7804	VM8804
Connectors	HDMI In	4 x HDMI Female (Black)	N/A
	HDMI Out	N/A	4 x HDMI Female (Black)
	Stereo Audio In	4 x captive screw connector, 5 pole	N/A
	Stereo Audio Out	N/A	4 x captive screw connector, 5 pole
LED	Status	1 (Green)	1 (Green)
Power Consumption		7W	23.13W
Environment	Operating Temp.	0–40°C	
	Storage Temp.	-20–60°C	
	Humidity	0–80% RH, Non-condensing	
Physical Properties	Housing	Metal	
	Weight	0.55 kg	0.58 kg
	Dimensions (L x W x H)	35.20 x 23.80 x 2.28 cm	

VM7604 / VM8604

Function		VM7604	VM8604
Connectors	DVI In	4 x DVI-D Female (White)	N/A
	DVI Out	N/A	4 x DVI-D Female (White)
	Stereo Audio In	4 x captive screw connector, 5 pole	N/A
	Stereo Audio Out	N/A	4 x captive screw connector, 5 pole
LED	Status	1 (Green)	1 (Green)
Power Consumption		10.62W	20.10W
Environment	Operating Temp.	0–40°C	
	Storage Temp.	-20–60°C	
	Humidity	0–80% RH, Non-condensing	
Physical Properties	Housing	Metal	
	Weight	0.55 kg	0.58 kg
	Dimensions (L x W x H)	35.20 x 23.80 x 2.28 cm	

VM7104

Function		VM7104
Connectors	VGA In	4 x HDB-15 Female (Blue)
	Stereo Audio In	4 x captive screw connector, 5 pole
LED	Status	1 (Green)
Power Consumption		7.1 W
Environment	Operating Temp.	0–40°C
	Storage Temp.	-20–60°C
	Humidity	0–80% RH, Non-condensing
Physical Properties	Housing	Metal
	Weight	0.56 kg
	Dimensions (L x W x H)	35.20 x 3.80 x 2.28 cm

VE805R

Function		VE805R
Connectors	HDMI Out	1 x HDMI Type A Female (Black)
	HDBaseT In	1 x RJ-45 Female (Silver)
	RS-232	1 x captive screw connector, 3 pole
	IR	1 x 3.5mm Phone Jack (Black)
	Power	1 x DC Jack (Black)
LED	Power	1 (Green)
	Link	1 (Orange)
	HDMI Out	1 (Orange)
Switch	F/W Upgrade	1 x Slide Switch
Power Consumption		DC 5V
Environment	Operating Temp.	0–40°C
	Storage Temp.	-20–60°C
	Humidity	0–80% RH, Non-condensing
Physical Properties	Housing	Metal
	Weight	0.83 kg
	Dimensions (L x W x H)	18.19 x 16.92 x 4.20 cm

VM-PWR400

Function		VM-PWR400
Properties	Input Voltage	100~240Vac
	Power Consumption	Max.Load 378W
	Operating Temp.	0–40°C

VM-FAN60

Function		VM-FAN60
Properties	Air Flow	60 cfm
	Operating Voltage	10.8-13.8 Vdc
	Operating Temp.	-10–70°C

Limited Warranty

IN NO EVENT SHALL THE DIRECT VENDOR'S LIABILITY EXCEED THE PRICE PAID FOR THE PRODUCT FROM DIRECT, INDIRECT, SPECIAL, INCIDENTAL, OR CONSEQUENTIAL DAMAGES RESULTING FROM THE USE OF THE PRODUCT, DISK, OR ITS DOCUMENTATION.

The direct vendor makes no warranty or representation, expressed, implied, or statutory with respect to the contents or use of this documentation, and especially disclaims its quality, performance, merchantability, or fitness for any particular purpose.

The direct vendor also reserves the right to revise or update the device or documentation without obligation to notify any individual or entity of such revisions, or update. For further inquiries, please contact your direct vendor.