



Multicast HDMI Wireless Extender

VE849

User Manual



www.aten.com

RoHS

This product is RoHS compliant.

SJ/T 11364-2006

The following contains information that relates to China.

部件名称	有毒有害物质或元素					
	铅	汞	镉	六价铬	多溴联苯	多溴二苯醚
电器部件	●	○	○	○	○	○
机构部件	○	○	○	○	○	○

- : 表示该有毒有害物质在该部件所有均质材料中的含量均在SJ/T 11363-2006规定的限量要求之下。
- : 表示符合欧盟的豁免条款，但该有毒有害物质至少在该部件的某一均质材料中的含量超出SJ/T 11363-2006的限量要求。
- ×: 表示该有毒有害物质至少在该部件的某一均质材料中的含量超出SJ/T 11363-2006的限量要求。

User Information

Online Registration

Be sure to register your product at our online support center:

International	http://eservice.aten.com
---------------	---

Telephone Support

For telephone support, call this number:

International	886-2-8692-6959
China	86-10-5255-0110
Japan	81-3-5615-5811
Korea	82-2-467-6789
North America	1-888-999-ATEN ext 4988
United Kingdom	44-8-4481-58923

User Notice

All information, documentation, and specifications contained in this manual are subject to change without prior notification by the manufacturer. The manufacturer makes no representations or warranties, either expressed or implied, with respect to the contents hereof and specifically disclaims any warranties as to merchantability or fitness for any particular purpose. Any of the manufacturer's software described in this manual is sold or licensed *as is*. Should the programs prove defective following their purchase, the buyer (and not the manufacturer, its distributor, or its dealer), assumes the entire cost of all necessary servicing, repair and any incidental or consequential damages resulting from any defect in the software.

The manufacturer of this system is not responsible for any radio and/or TV interference caused by unauthorized modifications to this device. It is the responsibility of the user to correct such interference.

The manufacturer is not responsible for any damage incurred in the operation of this system if the correct operational voltage setting was not selected prior to operation. PLEASE VERIFY THAT THE VOLTAGE SETTING IS CORRECT BEFORE USE.

Package Contents

The VE849T package consists of:

- ◆ 1 VE849T HDMI Wireless Transmitter
- ◆ 1 IR Remote Control with 2 AAA Batteries
- ◆ 1 IR Blaster Cable
- ◆ 1 Power Adapter (VE849T)
- ◆ 1 User Instructions*

The VE849R package consists of:

- ◆ 1 VE849R Multicast HDMI Wireless Receiver
- ◆ 1 Mini USB Power Adapter (VE849R)
- ◆ 1 IR Receiver Cable
- ◆ 1 HDMI Cable
- ◆ 1 User Instructions*

Note: The VE849T and VE849R are sold separately.

Check to make sure that all the components are present and that nothing got damaged in shipping. If you encounter a problem, contact your dealer.

Read this manual thoroughly and follow the installation and operation procedures carefully to prevent any damage to the unit, and/or any of the devices connected to it.

* Features may have been added to the VE849 since this manual was published. Please visit our website to download the most up-to-date version.

© Copyright 2015 ATEN® International Co., Ltd.

Manual Date: 2015-11-06

ATEN and the ATEN logo are registered trademarks of ATEN International Co., Ltd. All rights reserved.
All other brand names and trademarks are the registered property of their respective owners.

Contents

RoHS	ii
SJ/T 11364-2006	ii
User Information	iii
Online Registration	iii
Telephone Support	iii
User Notice	iii
Package Contents	iv
About this Manual	vii
Conventions	viii
Product Information	viii
Chapter 1.	
Introduction	
Overview	1
Features	2
Requirements	3
Source Device	3
Display Device	3
Components	4
VE849T Transmitter Front View	4
VE849R Receiver Front View	4
VE849T Transmitter Rear View	5
VE849R Receiver Rear View	5
IR Remote Control	6
Chapter 2.	
Hardware Setup	
VE849T - Transmitter Installation	7
VE849R - Receiver Installation	8
IR Cable Installation	8
Power	13
Chapter 3.	
Operation	
Overview	14
Basic Operation	14
IR Remote Control	15
POWER	15
INFO	15
IR	15
RX PAIR	16
Source	16
EDID Management	16

Appendix

Safety Instructions	18
General	18
Technical Support.....	20
International	20
North America.....	20
Specifications	21
Troubleshooting	22
Limited Warranty.....	24

About this Manual

This User Manual is provided to help you get the most from your system. It covers all aspects of installation, configuration and operation. An overview of the information found in the manual is provided below.

Chapter 1, *Introduction*, introduces you to the VE849 system. Its purpose, features and benefits are presented, its front and back panel components and remote control are described.

Chapter 2, *Hardware Setup*, describes how to set up your installation. The necessary steps needed to install the transmitter, receiver, and IR blaster are explained.

Chapter 3, *Operation*, explains the fundamental concepts involved in pairing transmitters and receivers, and operating the VE849, IR Blaster cable, remote control and EDID management.

An Appendix, provides specifications, troubleshooting, and other technical information regarding the VE849.

Conventions

This manual uses the following conventions:

- Monospaced Indicates text that you should key in.
- [] Indicates keys you should press. For example, [Enter] means to press the **Enter** key. If keys need to be chorded, they appear together in the same bracket with a plus sign between them: [Ctrl+Alt].
1. Numbered lists represent procedures with sequential steps.
- ◆ Bullet lists provide information, but do not involve sequential steps.
- Indicates selecting the option (on a menu or dialog box, for example), that comes next. For example, Start → Run means to open the *Start* menu, and then select *Run*.
-  Indicates critical information.

Product Information

For information about all ATEN products and how they can help you connect without limits, visit ATEN on the Web or contact an ATEN Authorized Reseller. Visit ATEN on the Web for a list of locations and telephone numbers:

International	http://www.aten.com
North America	http://www.aten-usa.com

Chapter 1

Introduction

Overview

The VE849 Multicast HDMI Wireless Extender extends your HDMI display up to 30m* from the HDMI source to up to four separate receivers using wireless technology. Easily connect two HDMI source devices, a local HDTV and up to four receivers connected to HDTVs – wirelessly with crystal clear image quality capable of streaming Full 1080p with 5.1 channel Dolby digital audio and 3D technology. Supporting Dynamic Frequency Selection (DFS), the VE849 is able to operate within the U-NII Worldwide radio band (operating within this regulated and less commonly used range greatly reduces Wi-Fi signal interference and improves transmission quality and stability). The included IR remote control allows you to switch between HDMI source devices from the receiver side, remotely; and allows you to watch a local and four wirelessly connected HDTV- simultaneously. The VE849 consists of a wireless audio/video transmitter and receiver. Consolidate your HDMI electronics and use the VE849 as a wireless 2-port HDMI switch to connect remote devices such as Blu-ray players and HD Cable boxes to design your own custom wireless entertainment space.

* Distance may vary depending on the actual environment; solid objects such as steel, concrete, or brick may cause interference and shorten the transmission distance.

Features

- ◆ Wirelessly extend four HDMI displays up to 30m from the HDMI source*
- ◆ Setup five HDTVs and view HD content on five HDTVs simultaneously*
- ◆ Connect and transmit wireless video content from your Blu-ray DVD player, HD Cable box or other HDMI device wirelessly
- ◆ Multicast signal – 1 transmitter streams HDMI transmissions to 4 receivers simultaneously
- ◆ Supports Dynamic Frequency Selection (DFS) - greatly reduces Wi-Fi signal interference for improved transmission quality and stability
- ◆ HDMI 1.4a compliant
- ◆ Wireless 3D Supported
- ◆ Wireless HD in Full 1080p and 5.1 channel Dolby with AC3 and DTS digital audio
- ◆ Video Resolutions: 480p, 720p, 1080i and 1080p (24 / 30 / 60fps)
- ◆ Local Transmitter: 2 HDMI Inputs and 1 HDMI Output
- ◆ Remote Receiver: 1 HDMI Output
- ◆ Keep home theater electronic devices neatly out-of-sight
- ◆ Supports video games consoles with less than 1ms latency
- ◆ Built-in IR receiver allows control of source devices from the remote side
- ◆ No software or driver installation needed
- ◆ HDCP Compliant
- ◆ Based on WHDI™ Technology - Low latency <1ms

* Distance may vary depending on the actual environment; solid objects such as steel, concrete, or brick may cause interference and shorten the transmission distance.

Requirements

Source Device

- ♦ A source player with an HDMI Type A output connector

Display Device

- ♦ A display device or receiver with an HDMI Type A input connector

Components

VE849T Transmitter Front View

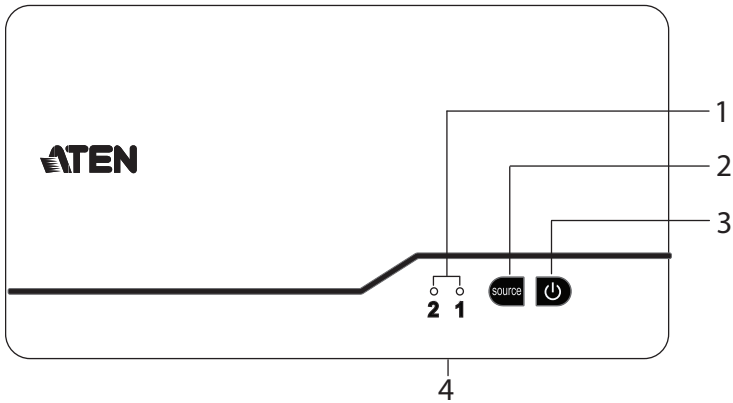

VE849R Receiver Front View

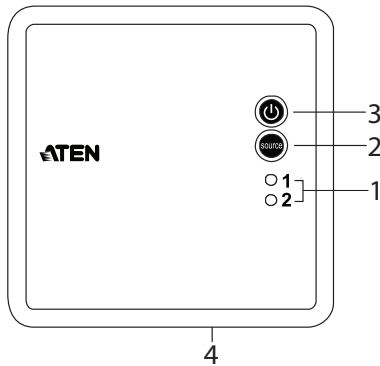

No.	Component	Description
1	Port LED	The selected port LED (Blue) lights up to indicate that the port is selected for use.
2	Port Selection Pushbutton	The port selection pushbutton switches the VE849 between the two connected HDMI media sources.
3	Power Pushbutton / LED	Press this button to turn the VE849 on / off. The blue LED indicates the VE849 is powered on,. The red LED indicates the VE849 is in power saving mode.
4	IR Receiver	This receives the signals from the IR remote control.

VE849T Transmitter Rear View

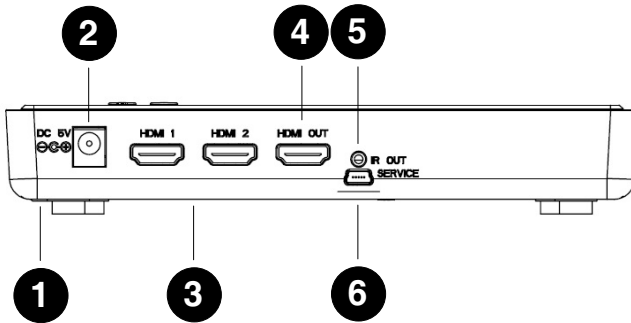

VE849R Receiver Rear View

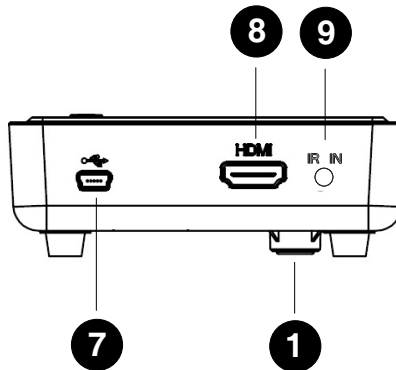

No.	Component	Description
1	Tripod Bracket	Use this bracket to mount the VE849 to a tripod.
2	Power Jack	The power adapter cable plugs in here.
3	HDMI In	The cables from the HDMI source devices plug into these ports.
4	HDMI Out	Plug the local HDMI display into this port.
5	IR Blaster Port	Plug the IR Blaster cable that came with your unit into this port.
6	Service Port	This port is used by the manufacturer to service the VE849.
7	USB Mini Power Adapter Port	The Mini USB Power Adapter that came with your unit plugs in here.
8	HDMI Out	Plug the remote HDMI display into this port.
9	IR Receiver	This receives signals from the IR remote control.

IR Remote Control

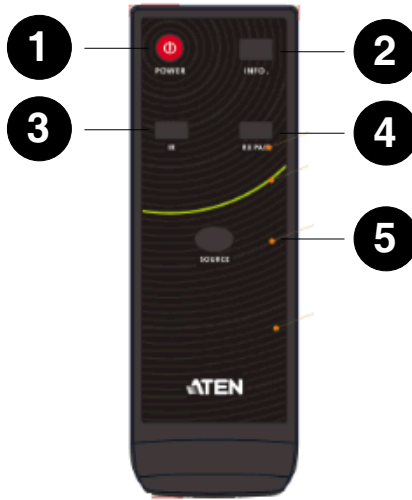

No.	Component	Description
1	Power	Press to turn transmitter and receiver on or off.
2	Info	Press to show on-screen display (OSD) information on the HDTV connected to the receiver.
3	IR	Press to switch the IR Blaster frequency to meet the media source devices requirements. Please refer to your source devices IR specifications for the correct frequency. The IR Blaster frequency ranges from 47KHz to 56KHz, to 38KHz recurring. The default is 47KHz.
4	RX Pair	Press this key twice to have a receiver (VE849R) enter pairing mode.
5	Source	Press to switch between the media sources connected to the transmitters HDMI In ports.

Chapter 2 Hardware Setup



1. Important safety information regarding the placement of this device is provided on page 18. Please review it before proceeding.
2. Make sure that the power to all devices connected to the installation are turned off.

To install the VE849 Multicast HDMI Wireless Extender, refer to the installation diagrams below as you preform the following steps:

VE849T - Transmitter Installation

1. Use an HDMI cable to connect the HDMI source device(s) to the HDMI input port(s) on the rear of the VE849T.
2. Use an HDMI cable to connect the local HDMI video display (HDTV) to the HDMI output port on the rear of the VE849T.
3. Plug the provided power adapter into an appropriate power source; plug the power adapter cable into the power jack on the VE849T.
4. Connect the IR Blaster cable included with your package into the IR Blaster port (see *IR Cable Installation*, page 8). (Optional)

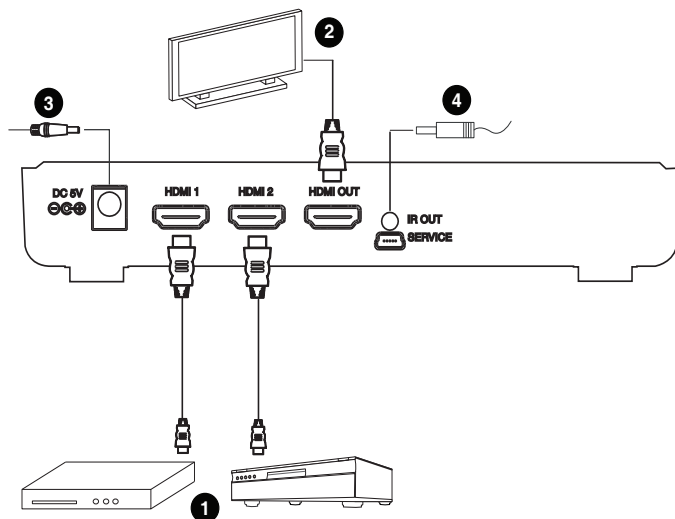

VE849R - Receiver Installation

1. Place the VE849R receiver up to 30m from the VE849T transmitter.
2. Use the HDMI cable included with this package to connect the HDMI video display (HDTV) to the HDMI output port on the rear of the VE849R receiver.
3. Plug the provided Mini USB Power Adapter into an appropriate power source; plug the power adapter cable into the USB port on the VE849R.

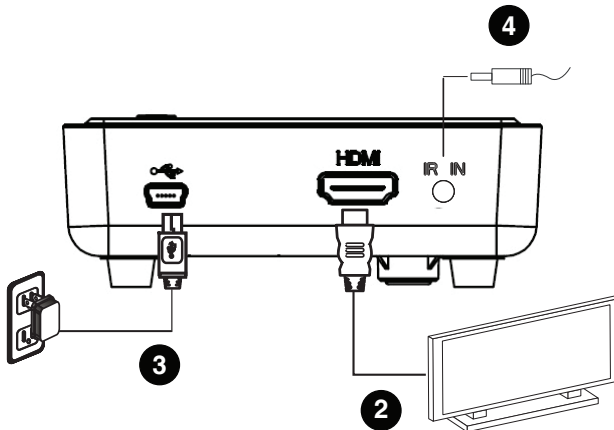

4. Connect the IR Blaster cable included with your package into the IR Blaster port (see *IR Cable Installation*, page 8). (Optional)
5. Repeat these steps to install up to 4 receivers (VE849R).

IR Cable Installation

The IR Blaster cable allows you to use a source device's remote control from the receiver side of the installation. To install the IR Blaster, do the following:

1. Plug the IR Blaster cable into the IR Out port on the rear of the transmitter.
2. Connect the IR Sensor Extender Cable to the IR In port on the VE849R, and attach the IR sensor to a visible area for IR remote control operation.

- Place the IR Blaster's sensors on or near the source device(s) front panel IR sensor port(s) (refer to the devices user manual for the exact location), so that it can communicate with the IR signal, as shown in red below.

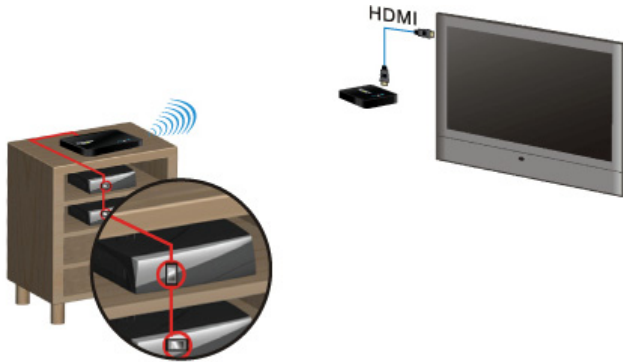

- Adjust the IR Blasters' sensors until the remote control can be used effectively from the receiver side of the installation
- For IR Blaster operational instructions, see *IR Blaster*, page 15, for details.

Note: The IR supports 47KHz to 56KHz to 38KHz recurring (NEC) remote signal protocols. Therefore, it is possible that some devices may not be supported for use.

Pairing

To connect the transmitter to a receiver, power off all units and follow the instructions below to put both units in pairing mode. Only one receiver can be powered on when its being paired with the transmitter.

1. On the transmitter, press and hold down the power button.



2. With the power button pressed, plug in the power adapter.



3. Press the power button until the power LED flashes purple, then release the power button.



4. When the power LED flashes purple its in pairing mode.

5. On the receiver, press and hold down the power button.



Note: You can also use the IR remote control to put the receiver into pairing mode. See *RX PAIR*, page 16, for details.

6. With the receiver's power button pressed, plug in the power adapter.



7. Press the power button until the power LED flashes purple, then release the power button.



8. When the receiver's power LED flashes purple its in pairing mode.

9. When the receiver is searching for the transmitter, the OSD will show:
Searching...
10. When the receiver and transmitter have found each others signal, the OSD will show:
Adding...
11. After the pairing is finished, both the transmitter and receiver will re-boot and establish a link to each other automatically. The power LED of the transmitter and receiver will light solid blue and the image below will appear on the receiver's TV screen:



12. To pair another receiver, unplug the power adapters for both the transmitter and receiver(s), then repeat the steps above. Each time you pair a new receiver with the transmitter make sure all power adapters are unplugged first.
13. After all devices have been paired successfully, plug-in one receiver's power adapter and then wait until it establishes a connection with the transmitter before plugging in the next receiver.

Power

To establish the best resolution for connected displays*, the VE849 will cause a normal short signal disruption to occur:

If both HDMI TVs and VE849T/VE849R units are on:

- ◆ Powering **off** and then **on** the local HDMI TV will cause the remote HDMI display signal to turn off for 5-10 seconds.
- ◆ Powering **off** and then **on** the remote HDMI TV will cause the local HDMI display signal to turn off for 5-10 seconds.
- ◆ Powering **off** the VE849 Transmitter or Receiver will cause the remote HDMI display signal to turn off, and local HDMI display signal to turn off for 5-10 seconds.
- ◆ Powering **off** and then **on** the VE849 Transmitter or Receiver will cause the local HDMI display signal to turn off for 5-10 seconds.

*For more information see *EDID Management*, page 16, for details.

Chapter 3

Operation

Overview

This chapter explains how to operate the VE849 Multicast HDMI Wireless Extender, IR Blaster, IR Remote control and EDID management.

Basic Operation

After installing the hardware, to begin using the VE849 Multicast HDMI Wireless Extender, refer to the instructions below, and do the following:

1. Pair the transmitter and receivers to establish the connections (see *IR Blaster*, page 15).
2. Power On the Transmitter and Receiver(s).
3. From the receiver side, turn the TV on and select the TV's HDMI input source for the VE849 Receiver's connection.
4. From the Transmitter, turn on the source device(s) and press the Source button (on top of the unit or from the remote control) to select the source device you would like to use: **HDMI 1** or **HDMI 2**.
5. With the Power LED on both units solid blue, video from the selected source device will be broadcast on the remote HDTV connected to the Receiver.

Note: If you don't get a display on the TV connected to the Receiver, press INFO on the VE849's remote control, then refer to the on-screen display (OSD) information, and see *Troubleshooting*, page 22 to resolve the issue.

IR Blaster

The IR Blaster allows you to use your HDMI source device's remote control from a TV connected wirelessly. To use the HDMI source device's remote control, install the IR Blaster (see *IR Cable Installation*, page 8), and point the HDMI source device's remote control at the VE849R Receiver. The signal will be sent through the IR Blaster to the HDMI source device. If you experience problems using an HDMI source device's remote control, you may need to change the IR frequency to meet the source device's IR specifications (see *IR*, page 15). The IR blaster supports frequency's of: 47KHz to 56KHz, to 38KHz recurring (default setting is 47KHz).

IR Remote Control

The VE849's IR remote control has five buttons, used for:

POWER

Press this button to power on/off the Transmitter or Receiver. When either unit is powered on via remote control, and a good wireless connection is established, the other unit will power on as well. This allows you to wirelessly power on both units, from either side.

INFO

Press this button to view status information about your current setup, displayed on the HDTV connected to the Receiver. This allows you to view and troubleshoot any issues. After pressing the INFO button, see *Troubleshooting*, page 22 for information on the message being displayed.

IR

Use this button to change the RF frequency for an HDMI source device's remote control, so that it can be used from the VE849R Receiver. Refer to your source devices user manual for the correct frequency, then change the VE849's setting to match it.

Press the IR button once to display the current RF frequency on the OSD of receiver's HDTV. Press the IR button twice to change the IR blaster's frequency. Options are: 47KHz to 56KHz to 38KHz recurring (default setting is 47KHz).

RX PAIR

Use this button to have a receiver enter pairing mode so that it can establish a connection to the transmitter. Point the IR remote at the receiver and press the **RX Pair** button once to show the OSD. Point the IR remote at the receiver and press the **RX Pair** button twice (within 5 seconds) to enter pairing mode. When the receiver's power LED flashes purple its in pairing mode. See *IR Blaster*, page 15 for complete instructions to pair a receiver with the transmitter.

Source

Press this button to switch between the HDMI media sources connected to the Transmitter.

EDID Management

EDID (Extended Display Identification Data) is the data provided by digital displays to indicate their capabilities to video sources.

The HDMI Wireless Extender distributes HDMI signals from your video source to five HDMI displays. In order to deliver the best audio and video formats supported by all TVs, the VE849 reads the EDID information from the displays and determines the best “common” video resolution and audio format to send to the video source to program EDID on the device (i.e. Blu-ray players auto resolution setting).

In order to provide the best “common” output resolution, for all displays, the VE849 reads the EDID whenever a TV is plugged in, unplugged, or turned on/off. It is normal to see the TVs flash for a couple seconds when they are powered on, or when switching source devices, this allows the EDID to adjust to the best “common” resolution for all devices to use.

To get the best resolution for a (single) specific TV (i.e. 1080p 3D), you can manually change the resolution from your video source or unplug the lower resolution EDID device, then power cycle the VE849 units and connected devices. For certain 3D Blu-ray players, you may need to eject and re-insert the 3D Blu-ray disk. If your video source does not output a best “common” resolution, one of your TVs may not display any content or it might play audio only. Please refer to your devices' user manual for further information if this issue appears. Below “Loop-through” refers to the locally connected HDTV.

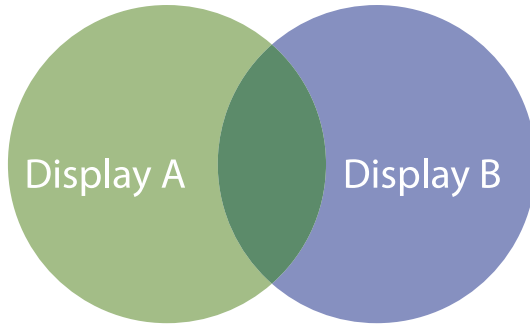

- Loop-through TV: 1080p 3D
- Remote TV: 720p
- Best Common: 720p

Safety Instructions

General

- ◆ This product is for indoor use only.
- ◆ Read all of these instructions. Save them for future reference.
- ◆ Follow all warnings and instructions marked on the device.
- ◆ Do not place the device on any unstable surface (cart, stand, etc.). If the device falls, serious damage will result.
- ◆ Do not use the device near water.
- ◆ Do not place the device near, or over, radiators or heat registers.
- ◆ The device cabinet is provided with slots and openings to allow for adequate ventilation. To ensure reliable operation, and to protect against overheating, these openings must never be blocked or covered.
- ◆ The device should never be placed on a soft surface (bed, sofa, rug, etc.) as this will block its ventilation openings. Likewise, the device should not be placed in a built in enclosure unless adequate ventilation has been provided.
- ◆ Never spill liquid of any kind on the device.
- ◆ Unplug the device from the wall outlet before cleaning. Do not use liquid or aerosol cleaners. Use a damp cloth for cleaning.
- ◆ The device should be operated from the type of power source indicated on the marking label. If you are not sure of the type of power available, consult your dealer or local power company.
- ◆ The device is designed for IT power distribution systems with 230V phase-to-phase voltage.
- ◆ To prevent damage to your installation it is important that all devices are properly grounded.
- ◆ The device is equipped with a 3-wire grounding type plug. This is a safety feature. If you are unable to insert the plug into the outlet, contact your electrician to replace your obsolete outlet. Do not attempt to defeat the purpose of the grounding-type plug. Always follow your local/national wiring codes.
- ◆ Do not allow anything to rest on the power cord or cables. Route the power cord and cables so that they cannot be stepped on or tripped over.

- ◆ If an extension cord is used with this device make sure that the total of the ampere ratings of all products used on this cord does not exceed the extension cord ampere rating. Make sure that the total of all products plugged into the wall outlet does not exceed 15 amperes.
- ◆ To help protect your system from sudden, transient increases and decreases in electrical power, use a surge suppressor, line conditioner, or un-interruptible power supply (UPS).
- ◆ Position system cables and power cables carefully; Be sure that nothing rests on any cables.
- ◆ Never push objects of any kind into or through cabinet slots. They may touch dangerous voltage points or short out parts resulting in a risk of fire or electrical shock.
- ◆ Do not attempt to service the device yourself. Refer all servicing to qualified service personnel.
- ◆ If the following conditions occur, unplug the device from the wall outlet and bring it to qualified service personnel for repair.
 - ◆ The power cord or plug has become damaged or frayed.
 - ◆ Liquid has been spilled into the device.
 - ◆ The device has been exposed to rain or water.
 - ◆ The device has been dropped, or the cabinet has been damaged.
 - ◆ The device exhibits a distinct change in performance, indicating a need for service.
 - ◆ The device does not operate normally when the operating instructions are followed.
- ◆ Only adjust those controls that are covered in the operating instructions. Improper adjustment of other controls may result in damage that will require extensive work by a qualified technician to repair.

Technical Support

International

- ◆ For online technical support – including troubleshooting, documentation, and software updates: <http://support.aten.com>
- ◆ For telephone support, see *Telephone Support*, page iii:

North America

Email Support		support@aten-usa.com
Online Technical Support	Troubleshooting Documentation Software Updates	http://www.aten-usa.com/support
Telephone Support		1-888-999-ATEN ext 4988



When you contact us, please have the following information ready beforehand:



- ◆ Product model number, serial number, and date of purchase.
- ◆ Your computer configuration, including operating system, revision level, expansion cards, and software.
- ◆ Any error messages displayed at the time the error occurred.
- ◆ The sequence of operations that led up to the error.
- ◆ Any other information you feel may be of help.

Specifications

Function		VE849T	VE849R
Video Input	Interface	2 x HDMI Type A Female (Black)	N/A
	Impedance	100 Ω	N/A
	Max. Distance	1.8 m	N/A
Video Output	Interface	1 x HDMI Type A Female (Black)	1 x HDMI Type A Female (Black)
	Impedance	100 Ω	100 Ω
Video	Max. Data Rate	6.75 Gbps (2.25 Gbps Per Lane)	6.75 Gbps (2.25 Gbps Per Lane)
	Max. Pixel Clock	225 MHz	225 MHz
	Compliance	HDMI (3D) HDCP compatible	HDMI (3D) HDCP compatible
	Max. Resolution / Distance	Up to 1080p@60Hz@30m	Up to 1080p@60Hz@30m
Audio	Input	2 x HDMI Type A Female (Black)	N/A
	Output	1 x HDMI Type A Female (Black)	1 x HDMI Type A Female (Black)
Control	IR	1 x 2.5mm Mini Stereo Jack Female (Black)	1 x 2.5mm Mini Stereo Jack Female (Black)
Power	Connector	1 x DC Jack	1 x DC Jack (Mini USB)
	Consumption	5 VDC, 10W	5 VDC, 7.5W (Mini USB)
Environment	Operating Temp.	0–40 °C	0–40 °C
	Storage Temp.	-20–60 °C	-20–60 °C
	Humidity	0–80% RH, Non-condensing	0–80% RH, Non-condensing
Physical Properties	Housing	Plastic	Plastic
	Weight	0.21 kg	0.13 kg
	Dimensions (L x W x H)	18.20 x 9.65 x 3.15 cm	9.50 x 9.50 x 3.15 cm

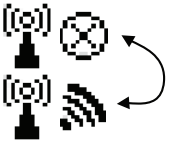
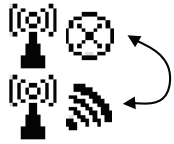
Troubleshooting

Status Description	Power LED (Receiver)	Source LED (Receiver)	OSD Display (Receiver TV)	Solution
Power saving mode Transmitter and Receiver are plugged in but the power is off.	Solid Red	Off		Turn the transmitter and receiver On using the Power button or Remote Control.
The transmitter is trying to establish a connection with the receiver.	Blinking Blue	Blinking	 4 Level Looping	The transmitter and receiver may take up to 20 seconds to establish the wireless connection. If this is the first time the two units have been powered on and the two devices haven't been paired see <i>IR Blaster</i> , page 15.
Searches available channels if the VE849 cannot establish a connection after the system boots up.	Blinking Blue	Blinking	 Looping displays	The receiver may be out of the transmitter's range. Please shorten the distance or remove any obstacles that might be obstructing the wireless signal. The maximum video transmission distance is 30m*.
No input signal from the selected HDMI source device.	Solid Blue	Blinking (Quickly)		Check to make sure the HDMI source device is powered on and connected to the correct input port on the transmitter.

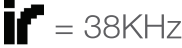
Status Description	Power LED (Receiver)	Source LED (Receiver)	OSD Display (Receiver TV)	Solution
The video format is not recognized.	Solid Blue	Blinking (Slow)		The video frame rate or resolution is not supported. Please adjust related video settings or try connecting the HDMI source device directly to the TV for further troubleshooting.
The VE849 is working properly and the video format is recognized.	Solid Blue	Solid Blue	 HDMI1 CH10 1280x1024	Signal Quality, Source, Channel, and resolution are displayed.
To change the IR frequency from the default setting.	-	-		Press the IR button on the remote control to change the IR frequency. (38KHz, 40KHz, or 33KHz)
3D Movie Support	-	-	-	3D is supported through the VE809 on all 3D capable TVs and devices. see <i>EDID Management</i> , page 16, or the 3D devices user manual for more information.

* Distance may vary depending on the actual environment; solid objects such as steel, concrete, or brick may cause interference and shorten the transmission distance.

Limited Warranty

IN NO EVENT SHALL THE DIRECT VENDOR'S LIABILITY EXCEED THE PRICE PAID FOR THE PRODUCT FROM DIRECT, INDIRECT, SPECIAL, INCIDENTAL, OR CONSEQUENTIAL DAMAGES RESULTING FROM THE USE OF THE PRODUCT, DISK, OR ITS DOCUMENTATION.

The direct vendor makes no warranty or representation, expressed, implied, or statutory with respect to the contents or use of this documentation, and especially disclaims its quality, performance, merchantability, or fitness for any particular purpose.

The direct vendor also reserves the right to revise or update the device or documentation without obligation to notify any individual or entity of such revisions, or update. For further inquiries, please contact your direct vendor.