

CAD Drawings

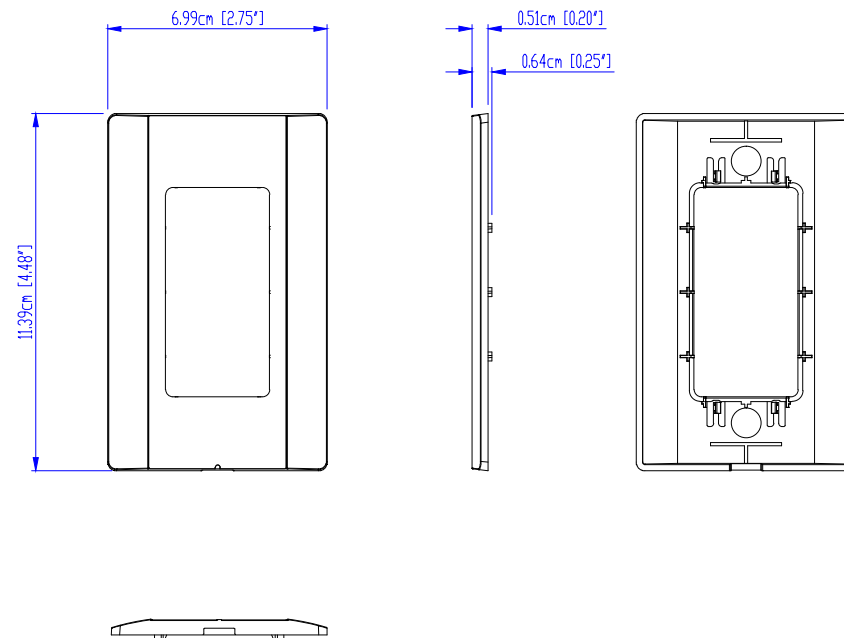

ATEN
VE1901AUST

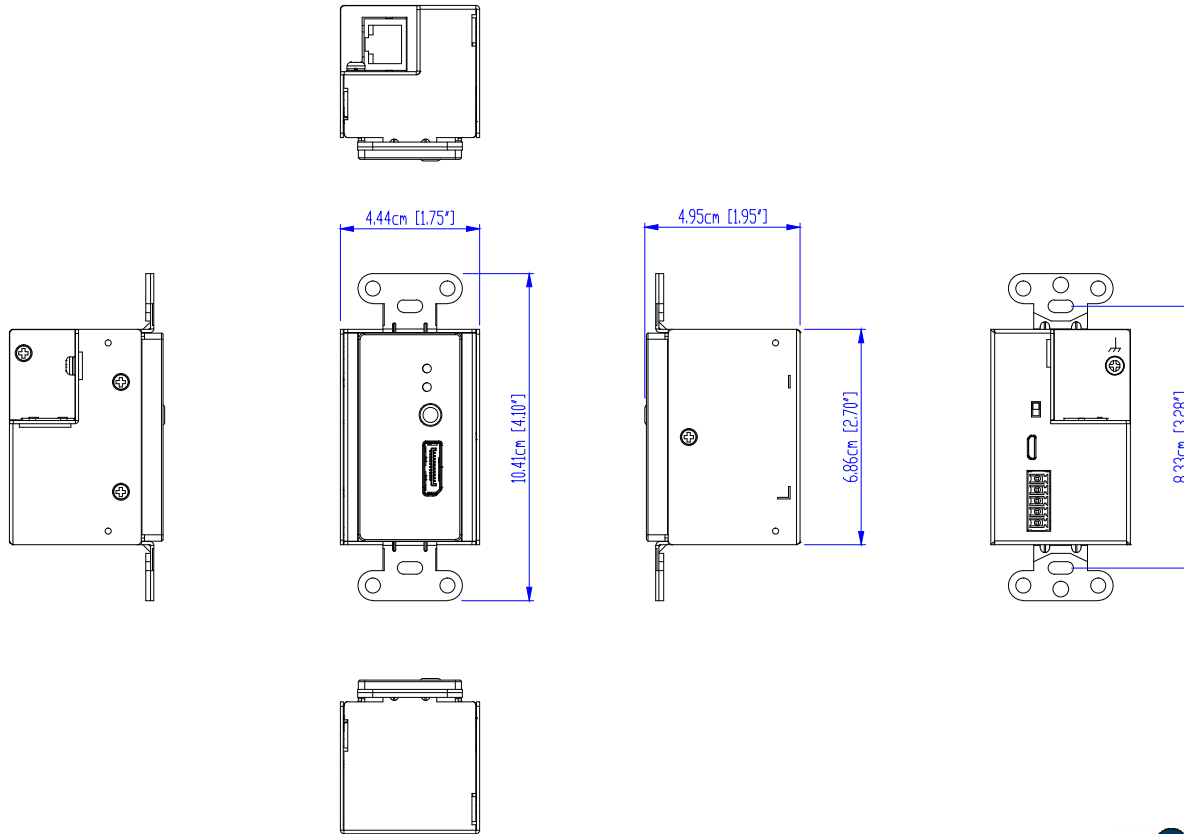

ATEN
VE1901AUST

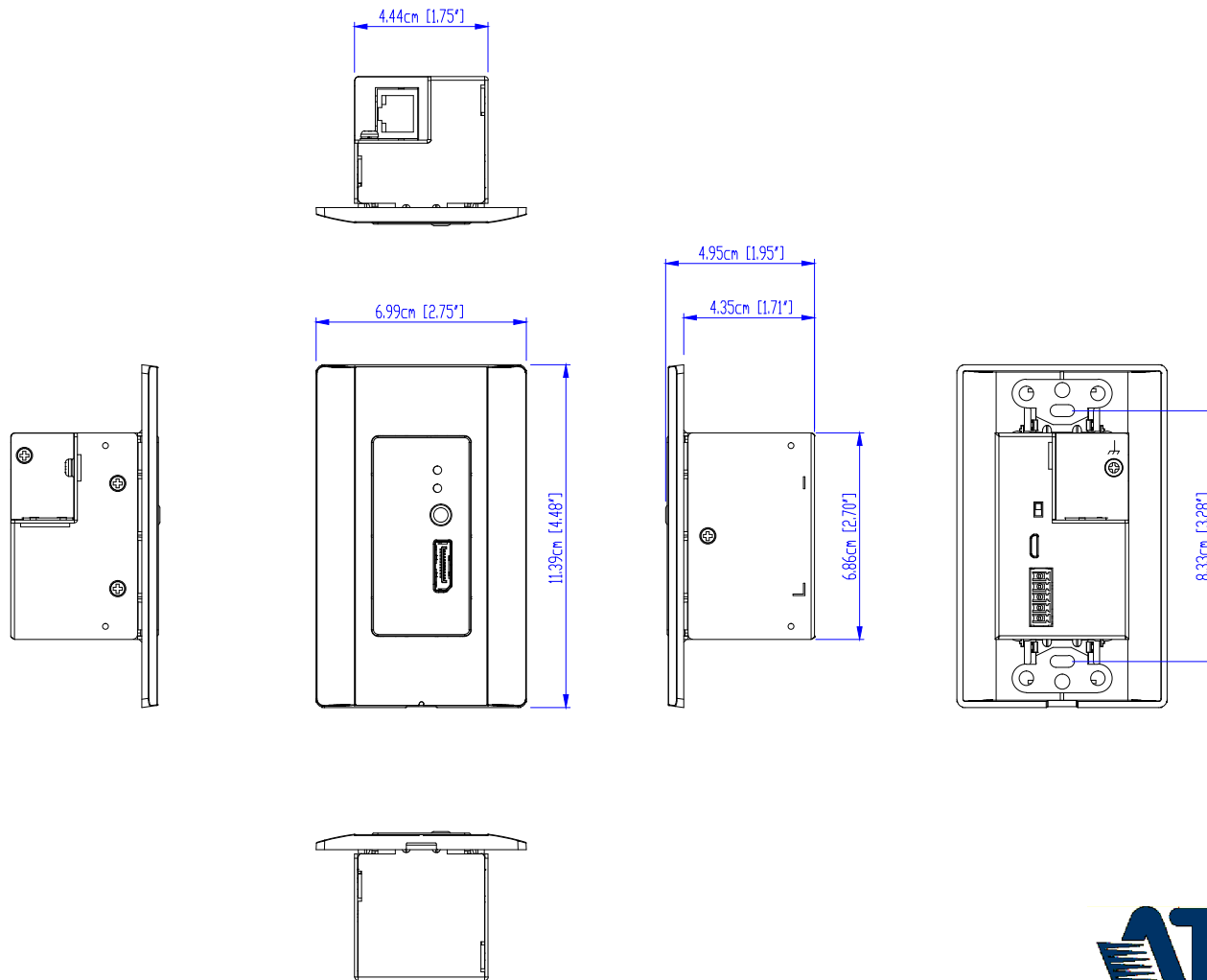

ATEN
VE1901AUST

Panel Mount Cutout

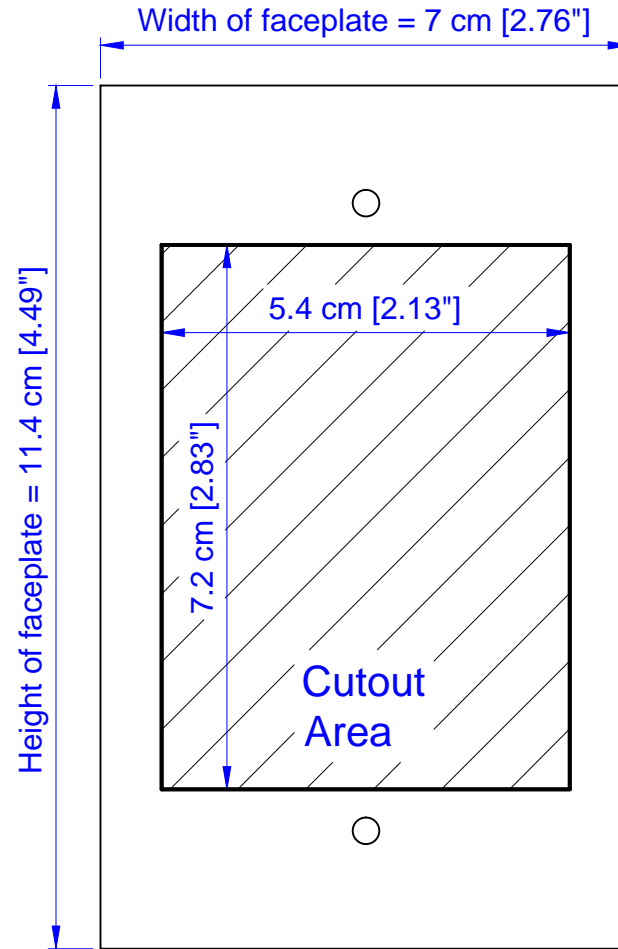

Note: ATEN recommends a 1-gang wall box with a depth of at least 5 cm (1.97 inches) to accommodate the connectors and cables.



VE1801AUST
VE1901AUST