



Simply Better Connections

ATEN NRGence™

**PE4104G**

IP Control Box  
User Manual

## Compliance Statements

---

### FEDERAL COMMUNICATIONS COMMISSION INTERFERENCE STATEMENT

This equipment has been tested and found to comply with the limits for a Class A digital device, pursuant to Part 15 of the FCC Rules. These limits are designed to provide reasonable protection against harmful interference when the equipment is operated in a commercial environment. This equipment generates, uses, and can radiate radio frequency energy and, if not installed and used in accordance with the instruction manual, may cause harmful interference to radio communications. Operation of this equipment in a residential area is likely to cause harmful interference in which case the user will be required to correct the interference at his own expense.

The device complies with Part 15 of the FCC Rules. Operation is subject to the following two conditions: (1) this device may not cause harmful interference, and (2) this device must accept any interference received, including interference that may cause undesired operation.

#### FCC Caution

Any changes or modifications not expressly approved by the party responsible for compliance could void the user's authority to operate this equipment.

#### Warning

Operation of this equipment in a residential environment could cause radio interference.

#### Achtung

Der Gebrauch dieses Geräts in Wohnumgebung kann Funkstörungen verursachen.



### KCC Statement

유선 제품용 / A 급 기기 ( 업무용 방송 통신 기기 )  
이 기기는 업무용 ( A 급 ) 전자파적합기기로서 판매자 또는 사용자는 이  
점을 주의하시기 바라며, 가정 외의 지역에서 사용하는 것을 목적으로  
합니다.

### RoHS

This product is RoHS compliant.

---

## About This Manual

---

This User Manual is provided to help you get the most from the PE4104G unit/system. It covers all aspects of installation, configuration and operation. An overview of the information in the manual is provided below.

**Chapter 1, Introduction**, introduces you to the unit/system. It presents purpose, features and benefits are presented, and its front and back panel components are described.

**Chapter 2, Hardware Setup**, provides step-by-step instructions for setting up your installation, and explains some basic operation procedures.

**Chapter 3, Basic Operation and First Time Setup**, explains the procedures that the Administrator employs to set up the PE4104G network environment, and change the default username and password.

**Chapter 4, Browser Operation**, describes how to log in to the PE4104G with an Internet browser, and explains the layout and components of the PE4104G's user interface.

**Chapter 5, Telnet Commands**, describes how to connect to and access the PE4104G's using Telnet.

**An Appendix**, at the end of the manual provides technical and troubleshooting information.

## Conventions

This manual uses the following conventions:

Monospaced	Indicates text that you should key in.
[ ]	Indicates keys you should press. For example, [Enter] means to press the <b>Enter</b> key. If keys need to be chorded, they appear together in the same bracket with a plus sign between them: [Ctrl+Alt].
1.	Numbered lists represent procedures with sequential steps.
◆	Bullet lists provide information, but do not involve sequential steps.
>	Indicates selecting the option (on a menu or dialog box, for example), that comes next. For example, Start > Run means to open the <i>Start</i> menu, and then select <i>Run</i> .
	Indicates critical information.

## Package Contents

---

- ◆ 1 PE4104G IP Control Box
- ◆ 1 standard rack mount kit
- ◆ 1 power cord
- ◆ 4 foot pads
- ◆ 1 user instructions\*

Check to make sure that all of the components are present and in good order. If anything is missing, or was damaged in shipping, contact your dealer.

Read this manual thoroughly and follow the installation and operation procedures carefully to prevent any damage to the unit or to any other devices connecting to the unit.

---

\* Features may have been added to the unit since this manual was published. Please visit our website to download the most up-to-date version.

---

---

## Product Information

---

For information about all ATEN products and how they can help you connect without limits, visit ATEN on the Web or contact an ATEN Authorized Reseller. Visit ATEN on the Web for a list of locations and telephone numbers:

International	<a href="http://www.aten.com">http://www.aten.com</a>
North America	<a href="http://www.aten-usa.com">http://www.aten-usa.com</a>

---

## User Information

---

### Online Registration

Be sure to register your product at our online support center:

International	<a href="http://support.aten.com">http://support.aten.com</a>
---------------	---

### Telephone Support

For telephone support, call this number:

International	886-2-8692-6959
China	86-400-810-0-810
Japan	81-3-5615-5811
Korea	82-2-467-6789
North America	1-888-999-ATEN ext 4988 1-949-428-1111

## **User Notice**

All information, documentation, and specifications contained in this manual are subject to change without prior notification by the manufacturer. The manufacturer makes no representations or warranties, either expressed or implied, with respect to the contents hereof and specifically disclaims any warranties as to merchantability or fitness for any particular purpose. Any of the manufacturer's software described in this manual is sold or licensed *as is*. Should the programs prove defective following their purchase, the buyer (and not the manufacturer, its distributor, or its dealer), assumes the entire cost of all necessary servicing, repair and any incidental or consequential damages resulting from any defect in the software.

The manufacturer of this system is not responsible for any radio and/or TV interference caused by unauthorized modifications to this device. It is the responsibility of the user to correct such interference.

The manufacturer is not responsible for any damage incurred in the operation of this system if the correct operational voltage setting was not selected prior to operation. **PLEASE VERIFY THAT THE VOLTAGE SETTING IS CORRECT BEFORE USE.**

If any bodily injury or property damage with respect to operation of the product results from users not having installed the product in accordance with the instructions provided in the product's user manual, or the product is used in an environment with a current load over the designed specifications of the product, ATEN is not liable for any loss or damage.

# Contents

---

Compliance Statements . . . . .	ii
About This Manual . . . . .	iii
Conventions . . . . .	iii
Package Contents . . . . .	iv
Product Information . . . . .	v
User Information . . . . .	v
Online Registration . . . . .	v
Telephone Support . . . . .	v
User Notice . . . . .	vi
Contents . . . . .	vii
<b>Chapter 1. Introduction</b>	
Overview . . . . .	1
Features . . . . .	2
Requirements . . . . .	3
Optional Accessories . . . . .	4
Sensors . . . . .	4
Sensor Management . . . . .	4
Cable Holders . . . . .	4
Components . . . . .	5
PE4104G Front View . . . . .	5
PE4104G Rear View . . . . .	6
<b>Chapter 2. Hardware Setup</b>	
Rack Mounting . . . . .	7
Desktop Mount . . . . .	7
Using the Rack Mount Ears . . . . .	7
Installation . . . . .	9
Securing the Cable . . . . .	10
<b>Chapter 3. Basic Operation and First Time Setup</b>	
Operation Methods . . . . .	11
Browser . . . . .	11
eco DC . . . . .	11
SNMP . . . . .	11
First Time Setup . . . . .	12
Network Configuration . . . . .	13
Changing the Administrator Login . . . . .	13
Moving On . . . . .	14
<b>Chapter 4. Browser Operation</b>	
Logging In . . . . .	15
The eco PDU Main Page . . . . .	17
Page Components . . . . .	17

Energy	19
Connections	19
PDU Status	19
Sensor Status	20
Outlet Status	20
Configuration	21
Power On Time Schedule Settings	21
Buzzer Setting	21
Outlet Configuration	21
User	25
Administrator Information	25
SNMPv3 Account Information	25
SNMPv1/v2c Community	26
Telnet	26
SSH	26
User Information	26
Log	28
System Log	28
Notification Settings	29
Setup	31
Device Configuration	31
General	31
Service Ports	32
IPv4 Configuration	33
Event Notification	34
Date/Time	37
Finishing Up	38
Security	39
Working Mode	40
TLS Support	40
IPInstaller Setting	40
Session Timeout	40
Account Policy	40
IP Filter / Mac Filter	41
Authentication & Authorization	44
Private Certificate	45
EcoTCP	46
PDU	47
Upgrade Main Firmware	47
Firmware File	47
Backup/Restore	49
Station List	49
Backup	49
Restore	50

## **Chapter 5. Telnet Commands**



---

Remote Terminal Operations .....	51
Telnet .....	51
Setup .....	51
Logging In .....	51
Session Timeout .....	52
Commands .....	53
Verification .....	53
Read Power Outlet Status .....	54
Switch Outlet Status .....	55
Read Environmental Value .....	57
Close Telnet Session .....	58
Reboot PDU Device .....	59
Reset All PDU Config to Default Value .....	59

## Appendix

Safety Instructions .....	61
General .....	61
Rack Mounting .....	63
Technical Support .....	64
International .....	64
North America .....	64
IP Address Determination .....	65
Method 1: .....	65
Method 2: .....	66
Method 3: .....	66
Specifications .....	67
PE4104G .....	67
Administrator Login Failure .....	69
Limited Warranty .....	70

This Page Intentionally Left Blank

# Chapter 1

## Introduction

### Overview

---

Engineered to be an intelligent power distribution solution, the PE4104G IP Control Box ships with 4 power outlets in an IEC socket configuration. It provides secure, centralized, intelligent, and remote power management of data center IT equipment to minimize the operating cost.

The PE4104G features remote power control function, allowing you to control devices attached to the PDU at the PDU device level from practically any location via a TCP/IP connection. The power sequence design eliminates the risks for a power inrush to guarantee reliable operation and protects the overall system health. With the support for eco DC software, it provides an easy method for managing multiple devices, offering an intuitive and user-friendly Graphical User Interface that allows you to configure a PDU device and reboot the device in case any equipment lock-up occurs. The administrators can switch on/off or set a delay time for each power outlet or individual power outlets group whenever, wherever.

The PE4104G boasts a slim, compact form factor and supports desk mount as well as rack mount, ensuring easy installation in confined spaces. It is a smart power control box tailored for hospitality or retail applications, such as digital signages and video walls, for edge computing devices, including routers, servers and cameras, or for any data center environments where there is no need to keep the servers powered on at all times.

## Features

---

### Power Distribution

- ◆ Space saving slim form factor
- ◆ IEC power outlet
- ◆ Separates power for the unit's own power and its power outlets – user interface is still accessible even when an overload condition trips the device's circuit breaker

### Remote Access

- ◆ Remote power control via TCP / IP and a built in 10/100 Ethernet port
- ◆ Network Interfaces: TCP / IP, UDP, HTTP, HTTPS, SSL, SMTP, ARP, NTP, DNS, SNMP V1&V2&V3, auto sense, Ping, Telnet, Modbus (Over TCP IP)
- ◆ Works with web-based eco DC software

### Operation

- ◆ Local and Remote power outlet control (On, Off, Power Cycle) by individual outlets
- ◆ Power-on sequencing – users can set the power on sequence and delay time for each port to allow equipment to be turned on in a proper order
- ◆ Easy setup and operation via a browser-based user interface

### Security

- ◆ Two-level password security
- ◆ Strong security features include password protection and advanced encryption technologies – TLS1.2
- ◆ Remote authentication support: RADIUS

## Requirements

---

- ◆ Browsers accessing the PE4104G unit must support 2048 and 4096 bit encryption.
- ◆ For cold booting of attached computers, the computer's BIOS must support *wake on LAN* or *System after AC Back*.
- ◆ For Safe Shutdown:
  - ◆ The computer must be running Windows (Windows 2000 or higher) or Linux.
  - ◆ The Safe Shutdown program (available by download from our website), must be installed and running on the computer.

## Optional Accessories

---

### Sensors

Sensors are optional accessories. You can use the PE4104G unit without sensors. However, if you want to have complete energy management of an instrumented data center with the use of the PE4104G, you would need to use eco DC software and install sensor to generate a complete energy-efficient data and chart. Higher sensor installation density is helpful to generate more accurate data. A sensor-enabled installation is required to generate a more complete energy-efficient data and chart. Higher sensor installation density is helpful to generate more accurate data. Available sensors are show in the table, below:

Sensor	Part Number
Temperature	EA1140
Temperature / Humidity	EA1240
Differential Pressure / Temperature	EA1340

### Sensor Management

Sensors can be managed via the PE4104G's built-in graphical user interface (GUI) or with the eco DC software that can be downloaded from the ATEN website.

### Cable Holders

Cable holders are optional accessories. For added safety, use ATEN Lok-U-Plug cable holders to secure the cables from your attached devices in place on the eco PDU unit. Use only the ATEN Lok-U-Plug cable holders that have been specifically designed to work with the eco PDU. Using any other kind of cable securing device could be highly dangerous. For more information, see *Securing the Cable*, page 10.

Part Number	Description
2X-EA07	Lok-U-Plug Cable Holder (10 pcs)
2X-EA08	Lok-U-Plug Installation Tool (4 pcs)
2X-EA10	C14 EZ-Lok Plug Connector (10 pcs)
2X-EA13	C14 Smart-Lok Plug Connector (10 pcs)

## Components

### PE4104G Front View

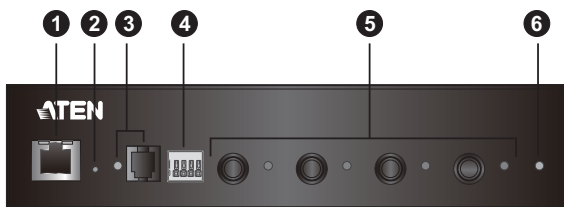

No.	Component	Description
1	LAN port	The Cat 5e cable that connects the unit to the Internet plugs in here.
2	reset button (recessed)	Press and release to reboot the unit. This reset button is recessed and must be pushed with a thin object, such as the end of a paper clip, or a ballpoint pen.
3	sensor port & LED	The external sensor plug into this RJ-11 port, and the sensor LED lights orange when a sensor is connected to the sensor port.
4	door sensor dry - contact port	The external door sensor plug into this door sensor dry - contact port.
5	power control buttons & LED	Each power control button (1 to 4), controls the power status of its corresponding AC output port as follow: <ul style="list-style-type: none"> <li>◆ Pressing and holding the button in for more than 3 seconds switches the power to its corresponding port on of off.</li> </ul> The LEDs light green to indicate that there is electricity going to its corresponding outlet.
6	device power LED	The device power LED lights orange to indicate the unit is powered up and ready to operate.

## **PE4104G Rear View**

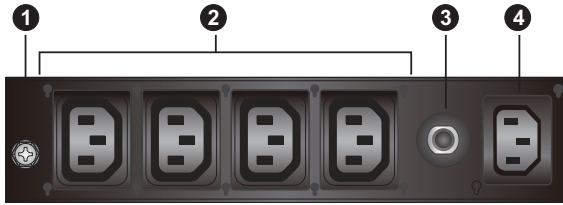

No.	Component	Description
1	grounding terminal	Connects to a suitable grounding object.
2	power outlet sockets	Electrical appliances plug in here.
3	circuit breaker	Protects the PDU from damage caused by excess current from an overload or short circuit.
4	power inlet socket	The power cord of the package content plugs in here.



# Chapter 2

## Hardware Setup



Important safety information regarding the placement of this device is provided on page 61. Please review it before proceeding.

### Rack Mounting

---

The PE4104G can be mounted vertically on the outside of the rack and a few options are available.

#### Desktop Mount

If you wish to keep your unit on a desktop, attach the foot pads (in the package content) and place the unit on any appropriate level surface that can safely support its weight plus the weight of its attached cables.

#### Using the Rack Mount Ears

1. Decide where you would rack mount the unit and choose the place you would attach the rack mount ear (Position 1, 2, 3, or 4). As an example, we will choose to attach the rack mount ear shown below (position 3).

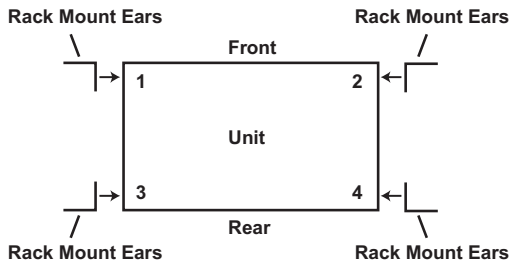

2. Align and stabilize the rack mount ear using M3 Phillips hex screws.

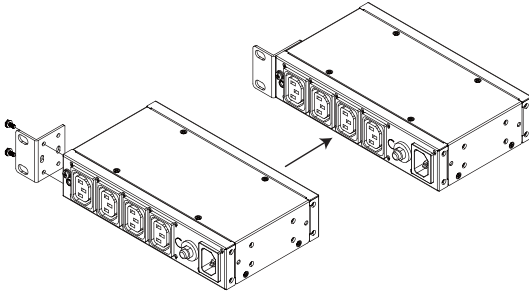

3. Align the unit and the rack mount ear to the rack and stabilize the unit using rack screws. Let the buttons stabilize in the button holes and the mounting is complete.

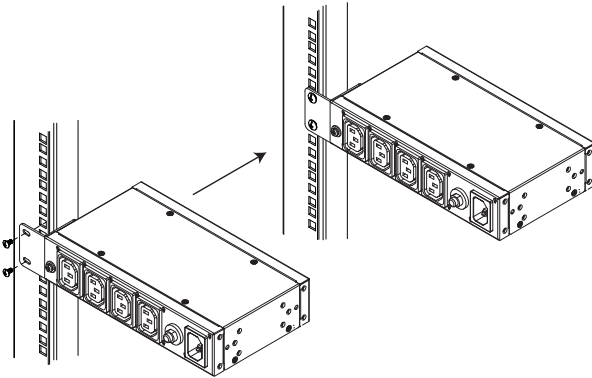

## Installation

To set up your PE4104G installation, refer to the numbered steps in the installation diagram below (the numbers in the diagram correspond to the numbered steps), and do the following:

1. Ground the PE4104G by connecting one end of a grounding wire to the grounding terminal and the other end to a suitable grounded object.

---

**Note:** Do not omit this step. Proper grounding helps to prevent damage to the unit from power surges or static electricity.

---

2. For each device you want to connect, connect its power cable to any available outlet on the unit. Optionally, use ATEN Lok-U-Plug cable holders to secure them. See *Securing the Cable*, page 10.
3. Connect an Internet-enabled LAN cable into the unit's LAN port.
4. (Optional) If you are to use an environmental sensor in your installation, connect it to the RJ-11 sensor port located on the unit's front panel.
5. (Optional) If you are to use a door sensor in your installation, connect it to the door sensor dry - contact port located on the unit's front panel.
6. Use the provided power cord to connect the unit's power inlet socket to an AC power source.
7. Once you have finished these installation steps, you can turn on the connected devices.

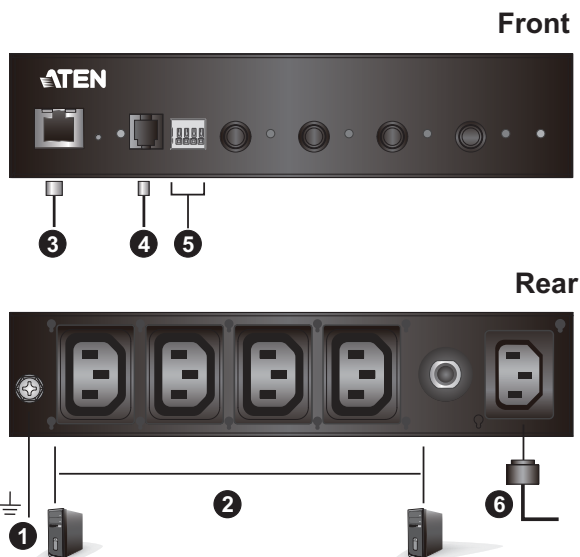

## **Securing the Cable**

For added safety, use ATEN Lok-U-Plug cable holders to secure the cables from your attached devices in place on the unit. Secure the cable holders using the specially designed holes around the individual power outlets, as shown below:

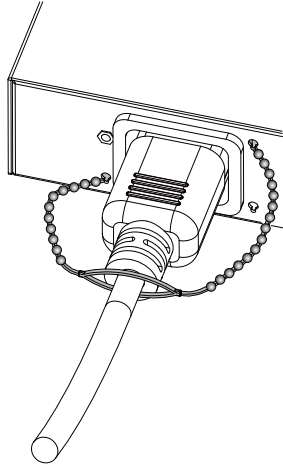

---

**Note:** Lok-U-Plug Cable Holders and their Installation Tools are optional and sold separately. See *Cable Holders*, page 4

---

---

### **Note:**

- ♦ Lok-U-Plug Cable Holders and their Installation Tools are optional and sold separately. See *Cable Holders*, page 4.
  - ♦ Use only the ATEN Lok-U-Plug cable holders that have been specifically designed to work with the eco PDU. Using any other kind of cable securing device could be highly dangerous.
-

# Chapter 3

## Basic Operation and First Time Setup

### **Operation Methods**

---

The PE4104G provide three methods to access and manage your installation: Browser, eco DC Energy Management Software and SNMP.

---

**Note:** The following sections of this chapter contain information concerning Browser operation. For eco DC operation, please refer to the separate eco DC User Manual. The eco DC software and User Manual can be downloaded from the ATEN website.

---

#### **Browser**

The PE4104G can be accessed and controlled via any supported Internet browser from any platform. See *First Time Setup*, page 12, and the following sections in this chapter, for full details.

#### **eco DC**

The eco DC Energy Management Software. eco DC provides you with an easy method for managing multiple devices, offering an intuitive and user-friendly Graphical Interface that allows you to configure a PDU device and monitor power status of the equipment connected to it. eco DC Energy Management Software can be downloaded from the ATEN website, along with a separate eco DC User Manual.

#### **SNMP**

The eco PDU supports any 3rd party V3 SNMP Manager Software. SNMP Management Information Database (MIB) files for the eco PDU device can be found on the software.

## First Time Setup

Once the eco PDU installation has been cabled up, the next task the Administrator needs to perform involve configuring the network parameters, changing the default Super Administrator login settings, and adding users.

The way to accomplish this is to log in via web browser.

- Note:** 1. Since this is the first time you are logging in, use the default Username: *administrator*; and the default Password: *password*. For security purposes we recommend changing them to something unique (see *Changing the Administrator Login*, page 13).
2. For remote methods of getting logged in to the PDU, see *IP Address Determination*, page 65.

After you successfully log in, the eco PDU Energy/Connections page appears:

The screenshot shows the NPGWebApp PE4104G Configuration page. The main content area is divided into three sections: PDU Status, Sensor Status, and Outlet Status.

**PDU Status Table:**

PDU Name	Measurement	Min Threshold	Max Threshold	PDU Status
PE4104G	Door Sensor	N/A		ON <input type="checkbox"/> Reboot OFF <input type="checkbox"/>

**Sensor Status Table:**

Sensor Port	Address	Temperature	Humidity	Pressure
Sensor1	IP: 1	25.19 °C	N/A	N/A

**Outlet Status Table:**

Outlet	Outlet Name	Auto Ping Status	Outlet Status	Outlet Switching
[01]		N/A	ON	ON <input type="checkbox"/> OFF <input type="checkbox"/> Reboot <input type="checkbox"/>
[02]		N/A	ON	ON <input type="checkbox"/> OFF <input type="checkbox"/> Reboot <input type="checkbox"/>
[03]		N/A	ON	ON <input type="checkbox"/> OFF <input type="checkbox"/> Reboot <input type="checkbox"/>
[04]		N/A	ON	ON <input type="checkbox"/> OFF <input type="checkbox"/> Reboot <input type="checkbox"/>

© Copyright 2016 ATEN & International Co., Ltd.

- Note:** Operation details are discussed in *Energy*, page 19, in the next chapter. For further setup information, continue with this chapter

## Network Configuration

To configure the network settings, do the following:

1. Click the **Setup** tab.
2. The interface displays the **Device Configuration** page. A screen similar to the one below appears:

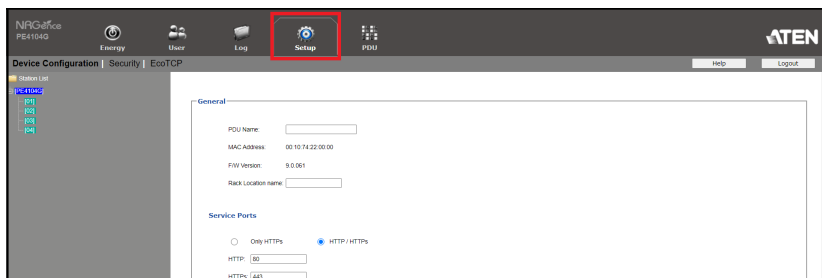

3. Fill in the fields according to the information provided under *Device Configuration*, page 31.

## Changing the Administrator Login

To change the default Administrator username and password, do the following:

1. Click the **User** tab.

The *Accounts* page has a detailed list of users – with more information about them – in the large central panel:

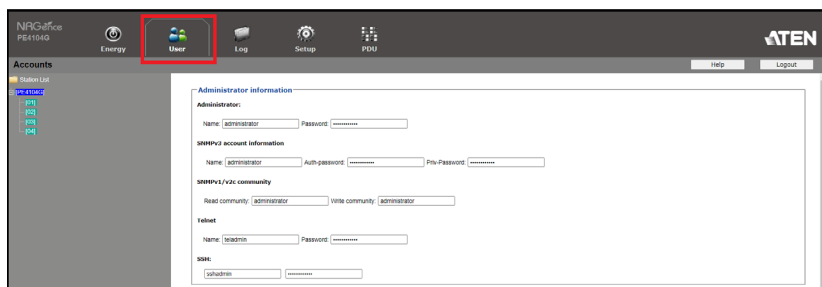

2. In the **Administrator Information** section, reset the name and password fields to something unique, then click **Save** (at the bottom of the page.)

**Note:** If you forget the Administrator’s name or password, short the mainboard jumper to restore the default Administrator account. See *Administrator Login Failure*, page 69 in the Appendix for full details.

## **Moving On**

---

After setting up the network and changing the default Administrator username and password, you can proceed to other administration activities – including adding users. This is covered in the next chapter.



# Chapter 4

## Browser Operation

### Logging In

---

The PE4104G can be accessed via a supported Internet browser from any platform.

**Note:** Browsers must support SSL 2048 and 4096 bit encryption.

---

To access the PE4104G do the following:

1. Open your browser and specify the IP address of the PE4104G you want to access in the browser's URL location bar.

**Note:** You can get the IP address from the PE4104G administrator, or see *IP Address Determination*, page 65, for information about setting it up yourself.

---

2. If a Security Alert dialog box appears, accept the certificate – it can be trusted. The Login page appears:

The screenshot shows the login interface for the PE4104G device. The page has a clean, professional look with a white background and a blue header for the login form. The ATEN logo is prominently displayed in the top left corner, and the NRGence logo is in the top right. The login form is centered and contains the following elements:

- Header:** PE4104G Please Login
- Username:** A text input field.
- Password:** A text input field.
- Language:** A dropdown menu currently showing 'English'.
- Buttons:** 'Login' and 'Reset' buttons.
- Footer:** - www.aten.com -

3. Provide a valid Username and Password (set by the administrator), and select your language. (Options are: English [default]; Traditional Chinese; Simplified Chinese; Japanese; German; Italian; Spanish; French; Russian; Korean; Portuguese).
4. Then Click **Login** to bring up the browser Main Page.

## The eco PDU Main Page

After you have successfully logged in, the PE4104G Main Page comes up with the Energy *Connections* page displayed:

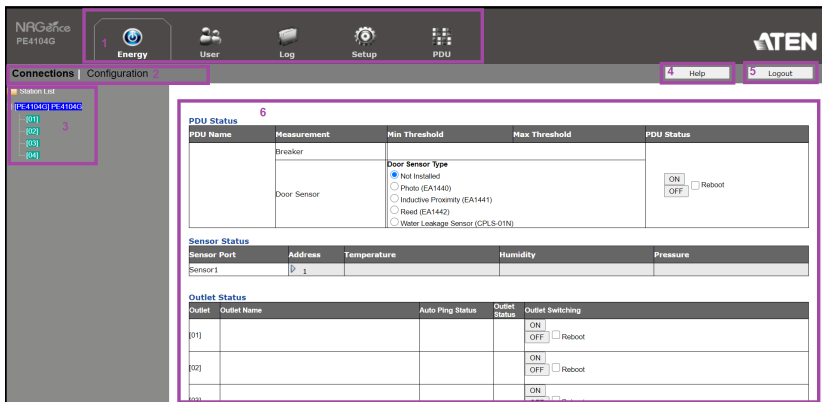

**Note:** The screen depicts an Administrator's page. Depending on a user's type and permissions, not all of these elements appear.

### Page Components

The web page screen components are described in the table, below:

No.	Item	Description
1	Tab Bar	The tab bar contains the PE4104G's main operation categories. The items that appear in the tab bar are determined by the user's type, and the authorization options that were selected when the user's account was created.
2	Menu Bar	The menu bar contains operational sub-categories that pertain to the item selected in the tab bar. The items that appear in the menu bar are determined by the user's type, and the authorization options that were selected when the user's account was created.
3	Sidebar	The Sidebar provides a tree view listing of outlets that relate to the various tab bar and menu bar selections.
4	Help	Connects to on-line help at the ATEN website for the device's configuration and operation.
5	Logout	Click this button to log out of your PE4104G session.

<b>No.</b>	<b>Item</b>	<b>Description</b>
6	Interactive Display Panel	This is your main work area. The screens that appear reflect your menu choices and Sidebar node selection.

# Energy

## Connections

When you log in to the PE4104G, the interface opens with its default selection of the *Energy* tab; and the *Connections* menu. The contents of the **PDU Status**, **Sensor Status**, and **Outlet Status** sections are displayed in the main panel.

The screenshot shows the NRGsoft PE4104G web interface. The top navigation bar includes 'Energy', 'User', 'Log', 'Setup', and 'PDU'. The main content area is divided into three sections:

- PDU Status:** A table with columns: PDU Name, Measurement, Min Threshold, Max Threshold, and PDU Status. The PDU Name is PE4104G. The Measurement is Breaker (ON) and Door Sensor (N/A). The Min Threshold is ON. The Max Threshold is N/A. The PDU Status has ON/OFF buttons and a Reboot button. Below this is a 'Door Sensor Type' section with radio buttons for: Not installed, Photo (EA1440), Inductive Proximity (EA1441), Reed (EA1442), and Water Leakage Sensor (CPLS-01N).
- Sensor Status:** A table with columns: Sensor Part, Address, Temperature, Humidity, and Pressure. The Sensor Part is SP-1, Address is 128.10 °C, Humidity is N/A, and Pressure is N/A.
- Outlet Status:** A table with columns: Outlet, Outlet Name, Auto Ping Status, Digital Status, and Outlet Switching. It lists outlets [01] through [04]. Each outlet has a Digital Status (ON/OFF) and an Outlet Switching (ON/OFF) button with a Reboot button.

## PDU Status

The PE4104G supports PDU device level monitoring. The **PDU Status** section allows you to set up a power management configuration for the PDU device as a whole:

PDU Name	Measurement	Min Threshold	Max Threshold	PDU Status
PE4104G	Breaker	ON		<input checked="" type="radio"/> ON <input type="radio"/> OFF <input type="button" value="Reboot"/>
	Door Sensor	N/A	<b>Door Sensor Type</b> <input checked="" type="radio"/> Not installed <input type="radio"/> Photo (EA1440) <input type="radio"/> Inductive Proximity (EA1441) <input type="radio"/> Reed (EA1442) <input type="radio"/> Water Leakage Sensor (CPLS-01N)	

- ◆ **Breaker On / Off**

This field indicates the breaker status.

**On:** Breaker status is normal

**Off:** Breaker is switched off and you have to manually switch the breaker to **On**.

- ◆ **Door Sensor Type**

You can choose a door sensor type for the connected door sensor by checking the available checkboxes.

### ◆ On / Off / Reboot

You can manually turn the device On and Off from this page by clicking the radio buttons. To Reboot the device, enable the Reboot checkbox and click on **Save** (located at the bottom of the page).

### Sensor Status

If you have sensors installed in your installation, use these fields to set the maximum, minimum and fluctuation threshold settings for Temperature, Humidity, and Differential Pressure.

Sensor Status				
Sensor Port	Address	Temperature	Humidity	Pressure
Sensor1	D_1	25.20 °C	N/A	N/A

**Note:** Sensors are optional accessories. Check with your dealer for information about eco DC software.

### Outlet Status

The PE4104G supports on, off and reboot control from the outlet status column for each outlet.

Outlet	Outlet Name	Auto Ping Status	Outlet Status	Outlet Switching
[01]		N/A	ON	<input type="radio"/> ON <input type="radio"/> OFF <input type="checkbox"/> Reboot
[02]		N/A	ON	<input type="radio"/> ON <input type="radio"/> OFF <input type="checkbox"/> Reboot
[03]		N/A	ON	<input type="radio"/> ON <input type="radio"/> OFF <input type="checkbox"/> Reboot
[04]		N/A	ON	<input type="radio"/> ON <input type="radio"/> OFF <input type="checkbox"/> Reboot

### ◆ On / Off / Reboot

You can manually turn the outlet On and Off from this page by clicking the radio buttons. To Reboot the outlet, enable the Reboot checkbox and click on **Save** (located at the bottom of the page).

When you have finished making your configuration settings, click **Save**.



## Configuration

The *Configuration* page is used to configure the settings of the PE4104G at the individual power outlet level.

<b>Power On Time Schedule Settings</b> <input type="checkbox"/> Enable Power On Time Schedule
<b>Buzzer Setting</b> <input type="checkbox"/> Enable Buzzer Alarm

### Power On Time Schedule Settings

Check the **Enable Power On Time Schedule** box to use the *Power ON Delay* setting to set the amount of time the eco PDU waits before powering on an outlet. See *Power ON Delay* in the table on the next page.

### Buzzer Setting

Checking the **Enable Buzzer Alarm** box sounds an alarm and sends SNMP trap or e-mail alerts when a threshold setting exceeds the minimum or maximum setting.

### Outlet Configuration

The *Outlet Configuration* section lets you set the power management settings for each outlet on the PDU.

Outlet Configuration		Confirmation Required	Delay Time (sec)		Remote Turn ON Method	Autoping Monitoring	
Outlet	Outlet Name		Power ON	Power OFF		Enable	Disable
[01]	<input type="text"/>	<input type="checkbox"/>	<input type="text" value="5"/>	<input type="text" value="1"/>	Method: <input type="text" value="Kill the Power"/> MAC Address: <input type="text" value="000000000000"/>	<input type="radio"/> Enable <input checked="" type="radio"/> Disable	Outlet control: <input type="radio"/> Enable <input checked="" type="radio"/> Disable Ping interval: <input type="text" value="60"/> (secs) Wait time before first ping: <input type="text" value="10"/> (secs) Consecutive failed pings (Reboot outlet): <input type="text" value="1"/> (times) Max outlet reboot times: <input type="text" value="1"/> (times) IP Address: <input type="text" value="0.0.0.0"/>
[02]	<input type="text"/>	<input type="checkbox"/>	<input type="text" value="5"/>	<input type="text" value="1"/>	Method: <input type="text" value="Kill the Power"/> MAC Address: <input type="text" value="000000000000"/>	<input type="radio"/> Enable <input checked="" type="radio"/> Disable	Outlet control: <input type="radio"/> Enable <input checked="" type="radio"/> Disable Ping interval: <input type="text" value="60"/> (secs) Wait time before first ping: <input type="text" value="10"/> (secs) Consecutive failed pings (Reboot outlet): <input type="text" value="1"/> (times) Max outlet reboot times: <input type="text" value="1"/> (times) IP Address: <input type="text" value="0.0.0.0"/>
[03]	<input type="text"/>	<input type="checkbox"/>	<input type="text" value="5"/>	<input type="text" value="1"/>	Method: <input type="text" value="Kill the Power"/> MAC Address: <input type="text" value="000000000000"/>	<input type="radio"/> Enable <input checked="" type="radio"/> Disable	Outlet control: <input type="radio"/> Enable <input checked="" type="radio"/> Disable Ping interval: <input type="text" value="60"/> (secs) Wait time before first ping: <input type="text" value="10"/> (secs) Consecutive failed pings (Reboot outlet): <input type="text" value="1"/> (times) Max outlet reboot times: <input type="text" value="1"/> (times) IP Address: <input type="text" value="0.0.0.0"/>
[04]	<input type="text"/>	<input type="checkbox"/>	<input type="text" value="5"/>	<input type="text" value="1"/>	Method: <input type="text" value="Kill the Power"/> MAC Address: <input type="text" value="000000000000"/>	<input type="radio"/> Enable <input checked="" type="radio"/> Disable	Outlet control: <input type="radio"/> Enable <input checked="" type="radio"/> Disable Ping interval: <input type="text" value="60"/> (secs) Wait time before first ping: <input type="text" value="10"/> (secs) Consecutive failed pings (Reboot outlet): <input type="text" value="1"/> (times) Max outlet reboot times: <input type="text" value="1"/> (times) IP Address: <input type="text" value="0.0.0.0"/>

Heading	Meaning
Outlet	Shows the port number of the listed outlet.
Outlet Name	Each outlet can be given a distinctive name. The maximum number of characters is 48.
Confirmation Required	If this option is enabled (there is a check in the checkbox), a dialog box comes up asking you to confirm a power operation before it is performed. If it is disabled (there is no check in the checkbox), the operation is performed without confirmation.
Delay Time (sec) Power ON	<p>Sets the amount of time the eco PDU waits after the Power Button is clicked (see <i>Outlet Status</i>, page 20), before it turns on the power to the outlet. You must check the <i>Enable Power On Time Schedule Setting</i> box for this setting to take effect. See <i>Power On Time Schedule Settings</i>, page 21, for details.</p> <p><b>Note:</b> The default delay time is 1 seconds; the maximum is 999 seconds. When a series of outlets are scheduled to be powered up, they turn on in sequence with a default delay of 10 milliseconds between each outlet.</p>
Delay Time (sec) Power OFF	<p>Sets the amount of time the eco PDU waits after the Power Button is clicked (see <i>Outlet Status</i>, page 20), before it turns off the power to the outlet.</p> <p>For the <i>System after AC Back</i> option (see below), after the delay time expires, the eco PDU waits another fifteen seconds, then shuts the computer down.</p> <p>The default delay time is 5 seconds. The maximum delay time is 999 seconds.</p>



Heading	Meaning
Remote Turn ON Method	<p>Use the drop-down menu to select one of the choices, below:</p> <p><b>Wake on LAN:</b> This is a Safe Shutdown and Restart option. If this is selected, when an Outlet is turned Off, the eco PDU first sends a message to the computer telling it to prepare for a shutdown; it then waits for the amount time set in the <i>Power Off Delay</i> field to give the OS time to close down before the computer is powered down to standby mode.</p> <p>Likewise, when the Outlet is turned On, the eco PDU waits for the amount time set in the <i>Power On Delay</i> field, then sends an Ethernet message to the computer connected to the Outlet telling the computer to turn itself On.</p> <p><b>Note:</b> For Safe Shutdown and Restart, the computer must be running Windows (98 or higher), or Linux, and the <i>Safe Shutdown</i> program (available by download from our website), must be installed and running on the computer.</p> <p><b>System after AC Back:</b> This is a Safe Shutdown and Restart option. If this is selected, when an Outlet is turned Off, the eco PDU first sends a message to the computer telling it to prepare for a shutdown; it then waits for the amount time set in the <i>Power Off Delay</i> field to give the OS time to close down before the computer is powered down.</p> <p>When the Outlet is turned On, the eco PDU waits for the amount time set in the <i>Power On Delay</i> field, then sends power to the server. When the server receives the power, it turns itself on.</p> <p><b>Note:</b> For Safe Shutdown and Reboot, the computer must be running Windows (98 or higher), or Linux, and the <i>Safe Shutdown</i> program (available by download from our website), must be installed and running on the computer.</p> <p><b>Kill the Power:</b> If this option is selected, the eco PDU waits for the amount time set in the <i>Power Off Delay</i> field, and then turns the Outlet's power Off. Turning the power off performs a cold (non-safe) shutdown.</p>
MAC Address	<p>In order to use either of the Safe Shutdown and Restart methods the MAC address of the computer connected to the outlet must be filled in here.</p>

Heading	Meaning
Autoping Monitoring	<p><i>Autoping Monitoring</i> pings a device at specified intervals and if there is no response (Request timed out) the PDU automatically powers cycles the outlet (off and then on). To enable Autoping Monitoring, check the <b>Enable</b> checkbox, or check the <b>Disable</b> checkbox to disable.</p> <p><b>Outlet control:</b> Automatically powers cycles the outlet (off and then on). To enable Outlet Control, check the <b>Enable</b> checkbox, or check the <b>Disable</b> checkbox to disable.</p> <p><b>Ping interval:</b> Enter the number of seconds to elapse between each auto-ping that is sent to test the network device.</p> <p><b>Wait time before first ping:</b> Enter the number of seconds of waiting time to ping the device after the first ping was sent to test the network device.</p> <p><b>Consecutive failed pings (Reboot outlet):</b> Enter the number of power cycles to attempt if the device cannot be pinged after the initial power cycle. If the device still cannot be pinged after the specified number of retries, the PDU will stop pinging the device and shut off and power on the outlet.</p> <p><b>Max outlet reboot times:</b> Enter the number for a maximum outlet reboot times for the network device can be rebooted after a specified consecutive failed pings.</p> <p><b>IP Address:</b> Enter the IP address of the device you want to ping.</p> <p><b>Port:</b> Enter the port number of the device you want Telnet to ping. This option is available when Telnet is selected.</p>

When you have finished making your configuration settings, click **Save**.

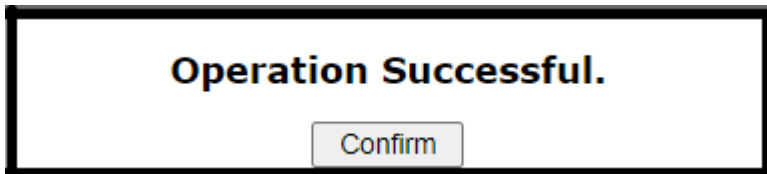

## User

When you select the *User* tab the screen comes up with *Administrator Information* and *User Information* displayed in the main panel. The PE4104G supports one Administrator account and up to eight User accounts.

- Note:**
1. Each account can support 2 login sessions.
  2. The PE4104G supports a total of 3 concurrent login sessions.

**Administrator information**

**Administrator:**

Name:  Password:

**SNMPv3 account information**

Name:  Auth-password:  Priv-Password:

**SNMPv1/v2c community**

Read community:  Write community:

**Telnet**

Name:  Password:

**SSH:**

**User information**

Management Name	Password	Outlet				
		All	G1	G2	G3	G4
Enable ▾   111111	<input type="password" value="password"/>	<input type="checkbox"/>	<input type="checkbox"/>	<input type="checkbox"/>	<input type="checkbox"/>	<input type="checkbox"/>
Disable ▾		<input type="checkbox"/>	<input type="checkbox"/>	<input type="checkbox"/>	<input type="checkbox"/>	<input type="checkbox"/>
Disable ▾		<input type="checkbox"/>	<input type="checkbox"/>	<input type="checkbox"/>	<input type="checkbox"/>	<input type="checkbox"/>
Disable ▾		<input type="checkbox"/>	<input type="checkbox"/>	<input type="checkbox"/>	<input type="checkbox"/>	<input type="checkbox"/>
Disable ▾		<input type="checkbox"/>	<input type="checkbox"/>	<input type="checkbox"/>	<input type="checkbox"/>	<input type="checkbox"/>
Disable ▾		<input type="checkbox"/>	<input type="checkbox"/>	<input type="checkbox"/>	<input type="checkbox"/>	<input type="checkbox"/>
Disable ▾		<input type="checkbox"/>	<input type="checkbox"/>	<input type="checkbox"/>	<input type="checkbox"/>	<input type="checkbox"/>
Disable ▾		<input type="checkbox"/>	<input type="checkbox"/>	<input type="checkbox"/>	<input type="checkbox"/>	<input type="checkbox"/>
Disable ▾		<input type="checkbox"/>	<input type="checkbox"/>	<input type="checkbox"/>	<input type="checkbox"/>	<input type="checkbox"/>

**Note:** There is a pre-installed administrator account. It can be used to set up the device and to begin creating users. The Username for this account is *administrator*; the password is *password*. For security purposes, we strongly recommend changing these to something unique.

### Administrator Information

This section is used to set the Administrator name and password. Only Administrators can view this section. For details, see *Changing the Administrator Login*, page 13.

### SNMPv3 Account Information

- ◆ Enter values for **Name**, **Auth-Password** and **Priv-Password** for SNMPv3 authentication, if required.

## SNMPv1/v2c Community

- ◆ Enter values **Read community** and **Write community** for SNMPv1/V2c authentication, if required.

## Telnet

- ◆ Use the Name and *Password* fields to change the account used to login via Telnet sessions.

## SSH

- ◆ Enter values in the required fields to change the account used to login via SSH.

When you have finished making your configuration settings, click **Save**.

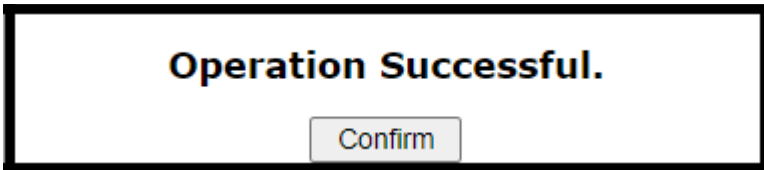

## User Information

To add a user, do the following:

1. Select the Enable or Disable in the Management drop-down menu.
2. Key in a name and password in the Name and Password fields.
3. Set the outlet-by-outlet permissions of the user in the Outlet field.
4. Click *Save* to save your settings.



---

**Note:** Values must be entered in both the Name and Password fields in order to enable an account.

---

The various options are explained in more detail in the following table:

Field	Description	
Management	The Management field allows you to Enable or Disable a user's account: <ul style="list-style-type: none"><li>◆ Enable – stores the user account (see <i>User Information</i>, page 26)</li><li>◆ Disable – disables the user account</li></ul>	

Field	Description
Name	From 1 to 16 characters are allowed depending on the Account Policy settings. See <i>Account Policy</i> , page 40.
Password	From 1 to 16 characters are allowed depending on the Account Policy settings. See <i>Account Policy</i> , page 40.
Outlet	This field allows you to set the outlet-by-outlet permissions of the user. Click on the user/port icon to cycle through the three permissions options, as follows:
	 User has complete access to this outlet.
	 User has read-only access to this outlet.
	 User has no access to this outlet.

When you have finished making your configuration settings, click **Save**.

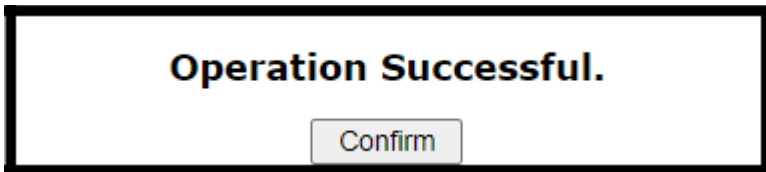

## Log

The *Log* tab keeps a record of transactions that take place on its installation, and stores up to 1024 events at one time. The *System Log* page provides a powerful array of filters and functions that allow you to view and export the log file data, as well as be informed by email of specified events as they occur.

No.	Date/Time	Category	Severity	User	Description
00001	2037-01-01 12:07:18	System	Information	administrator	Device configuration settings were modified by administrator
00002	2037-01-01 12:06:21	System	Information	administrator	Device configuration settings were modified by administrator
00003	2020-11-01 20:32:14	Authentication	Information	administrator	administrator 10.3.41.140 logged in
00004	2020-11-01 20:26:04	Authentication	Information	administrator	administrator 10.3.41.140 session timed out
00005	2020-11-01 20:09:07	Authentication	Information	administrator	administrator 10.3.41.140 logged in
00006	2020-11-01 19:59:48	Authentication	Information	administrator	administrator 10.3.52.159 logged out
00007	2020-11-01 19:53:02	Authentication	Information	administrator	administrator 10.3.52.159 logged in
00008	2020-11-01 19:02:14	Authentication	Information	administrator	administrator 10.3.52.50 logged out
00009	2020-11-01 17:31:46	Authentication	Information	administrator	administrator 10.3.52.50 logged in
00010	2020-10-29 21:17:14	Authentication	Information	administrator	administrator 10.3.52.50 session timed out
00011	2020-10-29 19:52:35	System	Information	administrator	Security settings were modified by administrator
00012	2020-10-29 19:52:18	Authentication	Information	administrator	administrator 10.3.52.50 logged in
00013	2020-10-29 19:50:06	Authentication	Information	administrator	administrator 10.3.52.50 session timed out
00014	2020-10-29 19:49:23	Authentication	Notification	administrator	administrator 10.3.52.50 login failed
00015	2020-10-29 19:49:17	Authentication	Notification	administrator	administrator 10.3.52.50 login failed
00016	2020-10-29 19:48:52	Authentication	Information	administrator	administrator 10.3.52.50 logged in
00017	2020-10-29 19:46:26	Authentication	Information	administrator	administrator 10.3.52.50 session timed out
00018	2020-10-29 19:45:14	Authentication	Information	administrator	administrator 10.3.52.50 logged in

## System Log

- ◆ Clicking on a device in the Sidebar displays its log events in the main panel's log event list.
- ◆ Clicking the **Refresh** button brings the log list up to date with the latest events.
- ◆ The entry box to the right of the Refresh button lets you set the number of events to display per page. Simply key in the number of your choice.
- ◆ The top right of the main panel shows the total number of pages in the log file, and what page you are currently viewing.
- ◆ The buttons on the bottom row function as follows:
  - ◆ **Clear** – click to erase the contents of the log event list
  - ◆ **First Page** – click to go to the first page of the log event list
  - ◆ **Previous Page** – click to move to the previous page of the log event list
  - ◆ **Next Page** – click to move to the next page of the log event list
  - ◆ **Last Page** – click to move to the last page of the log event list
  - ◆ **Save** – click to save the contents of the log event list to file. Select Csv or Txt type, can click Save.

**Log File Select**

Csv Type

Txt Type

## Notification Settings

The *Notification Settings* page is used to specify which of the PE4104G's components will receive notification of a log event. When you click the Notification Settings menu item, a page similar to the one below appears:

Event	Syslog	E-mail	SNMP
<b>Enable all system events</b>	<input checked="" type="checkbox"/>	<input checked="" type="checkbox"/>	<input checked="" type="checkbox"/>
Log export succeeded	<input checked="" type="checkbox"/>	<input checked="" type="checkbox"/>	<input checked="" type="checkbox"/>
System event log (SEL) cleaned	<input checked="" type="checkbox"/>	<input checked="" type="checkbox"/>	<input checked="" type="checkbox"/>
FW upgrade succeeded	<input checked="" type="checkbox"/>	<input checked="" type="checkbox"/>	<input checked="" type="checkbox"/>
FW upgrade failed	<input checked="" type="checkbox"/>	<input checked="" type="checkbox"/>	<input checked="" type="checkbox"/>
Device configuration restore succeeded	<input checked="" type="checkbox"/>	<input checked="" type="checkbox"/>	<input checked="" type="checkbox"/>
Device configuration restore failed	<input checked="" type="checkbox"/>	<input checked="" type="checkbox"/>	<input checked="" type="checkbox"/>
Device configuration backup succeeded	<input checked="" type="checkbox"/>	<input checked="" type="checkbox"/>	<input checked="" type="checkbox"/>
Device configuration settings modified	<input checked="" type="checkbox"/>	<input checked="" type="checkbox"/>	<input checked="" type="checkbox"/>
Security settings modified	<input checked="" type="checkbox"/>	<input checked="" type="checkbox"/>	<input checked="" type="checkbox"/>
FW upgrade started	<input checked="" type="checkbox"/>	<input checked="" type="checkbox"/>	<input checked="" type="checkbox"/>
Device rebooted	<input checked="" type="checkbox"/>	<input checked="" type="checkbox"/>	<input checked="" type="checkbox"/>
PDU get new IP address	<input checked="" type="checkbox"/>	<input checked="" type="checkbox"/>	<input checked="" type="checkbox"/>
<b>Enable all Authentication events</b>	<input checked="" type="checkbox"/>	<input checked="" type="checkbox"/>	<input checked="" type="checkbox"/>
<b>Enable all User Management events</b>	<input checked="" type="checkbox"/>	<input checked="" type="checkbox"/>	<input checked="" type="checkbox"/>
<b>Enable all Device Management events</b>	<input checked="" type="checkbox"/>	<input checked="" type="checkbox"/>	<input checked="" type="checkbox"/>

- ◆ The event categories are listed in the left column.
  - ◆ When you first open the page, only the main category items appear. (Main category item rows have a gray background.)
  - ◆ Sub-category items are nested under the main category headings. Click the arrow in front of the main category headings to display the subcategory items. (Sub-category item rows have a white background.)
- ◆ Click the checkboxes under the column headings to select which component(s) will receive notification of the log events.
  - ◆ Clicking on a main category heading's row automatically selects all the sub-category items nested below it.

- ◆ If you only want to set notification for some of the sub-category events, don't put a check in the main category row. Instead, drop down the sub-category list, and only check the sub-category events you want.
- ◆ When you have finished making your setting choices, click Save. When a specified log event occurs, notification of that event will be sent to the selected component.
- ◆ Reset Digital Output: If an event has been triggered that changes the digital output sensor from Low to High, click this button to return the sensor to the Low state.

When you have finished making your configuration settings, click **Save**.





## Setup

The *Setup* tab provides Device Configuration and Security settings. The *Device Configuration* page allows administrators to configure the PE4104G's system settings. The *Security* page controls access to the PDU.

### Device Configuration

This page presents information about the selected device, as described in the following sections:

#### General

**General**

PDU Name:

MAC Address: 00:10:74:22:00:00

F/W Version: 9.0.061

Rack Location name:

Item	Meaning
PDU Name	This field lets you give the device a unique name. Simply delete whatever is in the text box and key in the name of your choice. Click <b>Save</b> (located at the bottom of the page) to save the new name.
MAC Address	This item displays the PE4104G's MAC address.
Firmware Version	This item displays the current firmware version number. You can reference it to see if there are newer versions available on the ATEN website.
Rack Location Name	This field lets you give the rack location a unique name for easy reference.

## Service Ports

As a security measure, if a firewall is being used, the Administrator can specify the port numbers that the firewall will allow. If a port other than the default is used, users must specify the port number as part of the IP address when they log in. If an invalid port number (or no port number) is specified, the PE4104G will not be found.

Select whether to allow only secure browser logins, as show below:

### Service Ports

Only HTTPs                       HTTP / HTTPS

HTTP:

HTTPS:

An explanation of the fields is given in the table below:

Field	Explanation
HTTP	The port number for a browser login. The default is 80.
HTTPS	The port number for a secure browser login. The default is 443.

- 
- Note:**
1. Valid entries for all of the Service Ports are from 1–65535.
  2. The service ports cannot have the same value. You must set a different value for each one.
  3. If there is no firewall (on an Intranet, for example), it doesn't matter what these numbers are set to, since they have no effect.
-

## IPv4 Configuration

The PDU's IPv4 IP and DNS addresses (the traditional method of specifying IP addresses) can either be assigned dynamically (DHCP), or a fixed IP address can be specified.

### IPv4 Configuration

**Ethernet1**

Obtain IP address automatically [DHCP]

Set IP address manually [Fixed IP]

IP Address:

Subnet Mask:

Default Gateway:

Obtain DNS server address automatically

Set DNS server address manually

Preferred DNS Server:

Alternate DNS Server:

- ♦ For dynamic IP address assignment, select the *Obtain IP address automatically* radio button. (This is the default setting.)
- ♦ To specify a fixed IP address, select the *Set IP address manually* radio button and fill in the IP address with values appropriate for your network.
- ♦ For automatic DNS Server address assignment, select the *Obtain DNS Server address automatically* radio button.
- ♦ To specify the DNS Server address manually, select the *Set DNS server address manually* radio button, and fill in the addresses for the Preferred and Alternate DNS servers with values appropriate for your network.

**Note:** 1. If you choose *Obtain IP address automatically*, when the device starts up it waits to get its IP address from the DHCP server. If it hasn't

obtained the address after one minute, it automatically reverts to its factory default IP address (192.168.0.60.)

2. If the device is on a network that uses DHCP to assign network addresses, and you need to ascertain its IP address, see *IP Address Determination*, page 65, for information.
  3. Specifying the Alternate DNS Server address is optional.
- 

## Event Notification

The Event Notification section is divided into three sections: SMTP Server; SNMP Trap Receivers; and Syslog Server. Each section is described below.

### ◆ SMTP Server

**Event Notification**

**SMTP Server**

Enable report from the following SMTP Server

SMTP Server:

SMTP Port Number:

My server requires authentication

Account Name:

Password:

From:

To:

To have the PE4104G email reports from the SMTP server to you, do the following:

1. Enable the *Enable report from the following SMTP Server*, and key in the IP address and Port number of your SMTP server.
2. If your server requires authentication, put a check in the *My server requires authentication* checkbox.
3. Key in the appropriate account information in the *Account Name*, *Password*, and *From* fields.

---

**Note:** Only one email address is allowed in the *From* fields, and it cannot exceed 64 characters.

---

4. Key in the email address (addresses) of where you want the event reports sent to in the *To* field.

---

**Note:** If you are sending the report to more than one email address, separate the addresses with a semicolon. The total cannot exceed 256 characters.

---

◆ **SNMP Trap Receivers**

**SNMP Trap Receiver**

Enable SNMP Trap  SNMPv3  SNMPv2c  SNMPv1

Receiver IP 1:

Service Port 1:

Community 1:

User name 1:

Auth-password 1:

Priv-Password 1:

Receiver IP 2:

Service Port 2:

Community 2:

User name 2:

Auth-password 2:

Priv-Password 2:

Up to four SNMP management stations can be specified. If you want to use SNMP trap notifications, do the following:

1. Check *Enable SNMP Trap*.
2. Select which version of SNMP you want to use.
3. Key in the IP address(es) and the service port number(s) of the computer(s) to be notified of SNMP trap events. The valid port range is 1–65535. The default port number is 162.

---

**Note:** Make sure that the port number you specify here matches the port number used by the SNMP receiver computer.

---

4. Key in the community value(s) if required for the SNMP version.
  5. Key in the auth/privacy password(s) that correspond to each of the stations.
- ◆ **Syslog Server**

**Syslog Server**

Enable Syslog Server

Server IP:

Service Port:

To record all the events that take place on eco PDU devices and write them to the PE4104G's Syslog server, do the following:

1. Check **Enable Syslog Server**.
2. Key in the IP address and the port number of the Syslog server. The valid port range is 1-65535. The default port number is 514.

## Date/Time

The Date/Time dialog page sets the PE4104G time parameters:

**Date Time**

**Time Zone**

(GMT-12:00) Eniwetok Kwajalein

Daylight Savings Time

**Manual Input**

Date:  (YYYY-MM-DD)

Time:  (HH:MM:SS)

Sync with PC

**Network Time**

Enable auto adjustment

AU | ntp1.cs.mu.OZ.AU

Preferred custom server IP:

Alternate time server:

AU | ntp1.cs.mu.OZ.AU

Alternate custom server IP:

Adjust time every  days

### ◆ Time Zone

- ◆ To establish the time zone that the PE4104G is located in, drop down the *Time Zone* list and choose the city that most closely corresponds to where it is at.
- ◆ If your country or region employs Daylight Saving Time (Summer Time), check the corresponding checkbox.

### ◆ Manual Input

Use this section to specify the PE4104G's date and time manually.

- ◆ Click the calendar icon and click the calendar entry for the date.
- ◆ Key the time into the Time field, using the HH:MM:SS (hours, minutes, seconds) format.

---

**Note:** This section is only enabled when *auto adjustment* (in the *Network Time* section) is disabled (the checkbox is unchecked).

---

As an alternative to specifying the date and time by entering them into the date and time fields, you can click to put a check in the *Sync with PC* checkbox, in which case the eco PDU will take its date and time settings from the locally connected PC.

- ◆ Network Time

To have the time automatically synchronized to a network time server, do the following:

1. Check the *Enable auto adjustment* checkbox.
2. Drop down the time server list to select your preferred time server  
– or –

Check the *Preferred custom server IP* checkbox, and key in the IP address of the time server of your choice.

3. If you want to configure an alternate time server, check the *Alternate time server* checkbox, and repeat step 2 for the alternate time server entries.
4. Key in your choice for the number of days between synchronization procedures.

## Finishing Up

When you have finished making your settings on this page, click **Save**.

After you have saved your changes, if you want to synchronize immediately, click **Adjust Time Now**.



## Security

The *Security* page controls access to the PE4104G device.

### Security

---

#### Working Mode

- Enable Telnet Server
- Enable Modbus
- Enable SSH

#### TLS Support

- Enable TLS1.0/TLS1.1

#### IPInstaller Setting

Disable  Readonly  Read-write

#### Session Timeout

Enable Web Session Timeout in  Minute(s)

## Working Mode

- ◆ If *Enable Telnet Server* is checked, the PDU is accessible via a Telnet sessions using the Telnet username and password (see *Telnet*, page 26)
- ◆ If *Enable Modbus* is checked, the PDU is accessible and the measurements of the PDU such as current, voltage, power, temperature, humidity, and pressure can be read via the Modbus communications protocol.
- ◆ If *Enable SSH* is checked, the PDU is accessible and the measurements of the PDU such as current, voltage, power, temperature, humidity, and pressure can be read via the SSH cryptographic network protocol.

## TLS Support

- ◆ If *TLS Support* is checked, the PDU is accessible on older computers or older web browsers that support TLS1.0 or TLS1.1 data encryption.

## IP Installer Setting

- ◆ If *Disable* is checked, the IP address of the PE4104G cannot be found by the IP Installer software.
- ◆ If *Readonly* is checked, the IP address of the PE4104G can be found but not configurable by the IP Installer software.
- ◆ If *Read-write* is checked, the IP address of the PE4104G can be found and configurable by the IP Installer software.

## Session Timeout

- ◆ If *Enable Web Session Timeout in* is checked, a user's web session will logout due to inactivity after the number of *Minute(s)* entered (1–5) is surpassed.

## Account Policy

The Account Policy section governs policies in regard to usernames and passwords.

### Account Policy

Minimum Username Length:

Minimum Password Length:

Password Must Contain At Least:  One Upper Case

One Lower Case

One Number

Disable Duplicate Login

Check a policy and enter the required information in the appropriate fields.

Item	Description
Minimum Username Length	Sets the minimum number of characters required for a username. Acceptable values are from 1–16.
Minimum Password Length	Sets the minimum number of characters required for a password. Acceptable values are from 1–16.
Password Must Contain At Least	Checking any of these items requires users to include at least one of the specified items in their password. <b>Note:</b> This policy does not affect existing user accounts. Only new user accounts created after this policy has been enabled, and users required to change their passwords are affected.
Disable Duplicate Login	Check this to prevent users from logging in with the same account at the same time.

## IP Filter / Mac Filter

If any filters have been configured, they appear in the IP Filter and/or MAC Filter list boxes.

IP and MAC Filters control access to the eco PDU based on the IP and/or MAC addresses of the client computers attempting to connect. A maximum of 5 IP filters and 5 MAC filters are allowed.

To enable IP and/or MAC filtering, click to put a check mark in the *IP Filter Enable* and/or *MAC Filter Enable* checkbox.

- ◆ If the include button is checked, all the addresses within the filter range are allowed access; all other addresses are denied access.

- ◆ If the exclude button is checked, all the addresses within the filter range are denied access; all other addresses are allowed access.

### IP Filter/MAC Filter

IP Filter Enable     Include     Exclude

MAC Filter Enable     Include     Exclude

- ◆ **Adding Filters**

To add an IP filter, do the following:

1. Click **Add**. A dialog box similar to the one below appears:

**Enter the start IP address (for example, 192.168.0.1):**

**Enter the end IP address (for example, 192.168.1.255):**

2. Specify the start filter address in the dialog box (for example, 192.168.0.200), then click **OK**.
  3. To filter a single IP address, key in the same address as the start IP. To filter a continuous range of addresses, key in the end number of the range (for example, 192.168.0.225).
  4. After filling in the address, click **OK**.
- Repeat these steps for any additional IP addresses you want to filter.

To add a MAC filter, do the following:

1. Click **Add**. A dialog box similar to the one below appears:

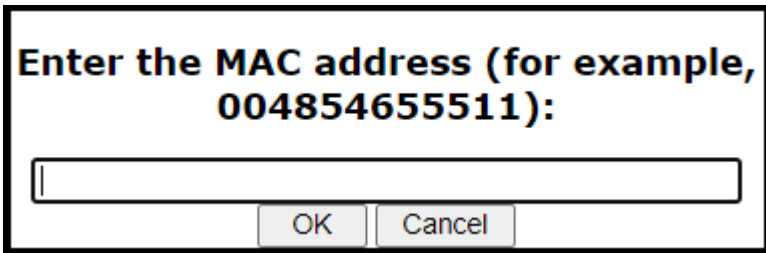

2. Specify the MAC address in the dialog box (for example, 001074670000), then click **OK**.

Repeat these steps for any additional MAC addresses you want to filter.

#### ◆ **IP Filter / MAC Filter Conflict**

If there is a conflict between an IP filter and a MAC filter – for example, where a computer’s IP address is allowed by the IP filter but its MAC address is excluded by the MAC filter – then that computer’s access is blocked.

In other words, if either filter blocks a computer, then the computer is blocked, no matter what the other filter is set to.

#### ◆ **Modifying Filters**

To modify a filter, select it in the IP Filter or MAC Filter list box and click **Modify**. The Modify dialog box is similar to the Add dialog box. When it comes up, simply delete the old address(es) and replace it with the new one(s).

#### ◆ **Deleting Filters**

To delete a filter, select it in the IP Filter or MAC Filter list box and click **Delete**.

## Authentication & Authorization

The Authentication & Authorization page is used to set up login authentication and authorization management from external sources.

### Authentication & Authorization

**RADIUS Settings**

Enable RADIUS

Preferred RADIUS Server IP:

Preferred RADIUS Service Port:

Alternate RADIUS Server IP:

Alternate RADIUS Server Port:

Timeout:  sec

Retries:

Shared Secret (at least 6 characters):

### ◆ RADIUS Settings

To allow authentication and authorization for the eco PDU device through a RADIUS server, do the following:

1. Check **Enable**.
2. Fill in the IP addresses and service port numbers for the Preferred and Alternate RADIUS servers. The default port number for the Preferred server is 1812; the default port number for the Alternate server is 1645.

---

**Note:** Make sure that the port numbers you specify here match the port numbers used by the RADIUS servers.

---

3. In the *Timeout* field, set the time in seconds that the eco PDU device waits for a RADIUS server reply before it times out.
4. In the *Retries* field, set the number of allowed retries for attempting to connect to the RADIUS server.
5. In the *Shared Secret* field, key in the character string that you want to use for authentication between the eco PDU device and the RADIUS Server.
6. On the RADIUS server, set the entry for each user as follows:

```
su/administrator or su/user
```

Where *xxxx* represents the Username given to the user when the account was created on the eco PDU device. The user's access rights are the ones assigned for the eco PDU device, as well. (See *User Information*, page 26.)

---

**Note:** `su/user` supports view ports only; `su/administrator` supports all eco PDU functions.

---

## Private Certificate

When logging in over a secure (SSL) connection, a signed certificate is used to verify that the user is logging in to the intended site. For enhanced security, the *Private Certificate* section allows you to use your own private encryption key and signed certificate, rather than the default ATEN certificate.

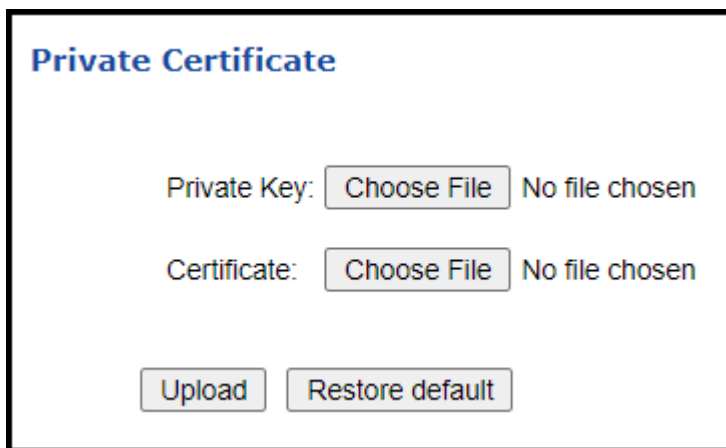

The screenshot shows a web interface titled "Private Certificate". It contains two rows of input fields. The first row is labeled "Private Key:" and has a "Choose File" button followed by the text "No file chosen". The second row is labeled "Certificate:" and has a "Choose File" button followed by the text "No file chosen". At the bottom of the form, there are two buttons: "Upload" and "Restore default".

There are two methods for establishing your private certificate: generating a self-signed certificate; and importing a third-party certificate authority (CA) signed certificate.

- ◆ **Generating a Self-Signed Certificate**

If you wish to create your own self-signed certificate, a free utility – `openssl.exe` – is available for download over the web.

- ◆ **Obtaining a CA Signed SSL Server Certificate**

For the greatest security, we recommend using a third party certificate authority (CA) signed certificate. To obtain a third party signed certificate, go to a CA (Certificate Authority) website to apply for an SSL certificate.

After the CA sends you the certificate and private encryption key, save them to a convenient location on your computer.

◆ **Importing the Private Certificate**

To import the private certificate, do the following:

1. Click **Browse** to the right of *Private Key*; browse to where your private encryption key file is located; and select it.
2. Click **Browse** to the right of *Certificate*; browse to where your certificate file is located; and select it.
3. Click **Upload** to complete the procedure.

---

**Note:** 1. Clicking **Restore Default** returns the device to using the default ATEN certificate.

2. Both the private encryption key and the signed certificate must be imported at the same time.
- 

When you have finished making your settings on this page, click **Save**.

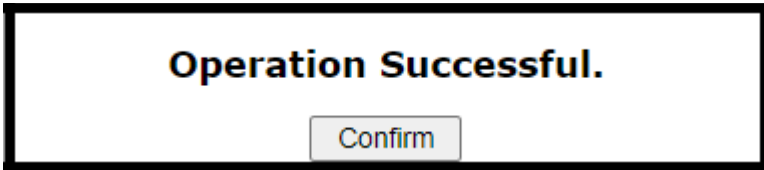

## **EcoTCP**

The *EcoTCP* page enables the communication between ecoDC software and the PE4104G. To enable the EcoTCP, check the Enable service checkbox and specify the EcoDC IP and the EcoDC Port number.

A screenshot of the EcoTCP configuration form. The form has a title "EcoTCP" in blue. Below the title is a checkbox labeled "Enable service". Underneath are two input fields: "EcoDC IP:" with the value "0.0.0.0" and "EcoDC Port:" with the value "8001". The input fields have a light gray background and a thin border.



## PDU

The *PDU* tab is used to upgrade the PE4104G's firmware, and to backup and restore the device's configuration settings.

### Upgrade Main Firmware

The *Upgrade Main Firmware* page is used to upgrade the firmware of the PE4104G.

#### Firmware File

When you click the **Upgrade Main Firmware** tab, the display opens with the *Firmware file* menu page, which looks similar to the one below:

Energy Box Name	F/W Version
PE4104G	F/W Version: 9.0.061

A description of the items shown in this panel are given in the table, below:

Item	Description
Check Main Firmware Version	If you enable <i>Check Main Firmware Version</i> , the eco PDU's current firmware level is compared with that of the upgrade file. If the current version is equal to or higher than the upgrade version, a popup message appears, to inform you of the situation and stops the upgrade procedure.
Name	Lists all of the eco PDU devices. Click to put a check in the checkbox of the device's whose firmware you want to upgrade.
F/W Version	Displays the eco PDU's current firmware version.
Filename	As new versions of the firmware become available, they are posted on our website and can be downloaded to a convenient location on your computer. Click the <i>Browse</i> button to select the downloaded upgrade file.
Upgrade	Click this button to upgrade the firmware of the selected devices.

#### ◆ Upgrading the Firmware

To upgrade the firmware refer to the screenshot on the preceding page, and do the following:

1. Go to our website and download the new firmware file to a convenient location on your computer.

2. Click the *Browse* button; navigate to where the firmware file is located and select it.
3. Click **Upgrade** to start the upgrade procedure.
  - ◆ If you enabled *Check Main Firmware Version* the current firmware level is compared with that of the upgrade file. If the current version is equal to or higher than the upgrade version, a popup message appears, to inform you of the situation and stops the upgrade procedure.
  - ◆ If you didn't enable *Check Main Firmware Version*, the upgrade file is installed without checking what its level is.
  - ◆ Once the upgrade completes successfully, the switch resets itself.
4. Log in again, and check the firmware version to be sure it is the new one.

#### ◆ **Firmware Upgrade Recovery**

Should the eco PDU's firmware upgrade procedure fail, and the device becomes unusable, the following firmware upgrade recovery procedure will resolve the problem:

1. Power off the device.
2. Press and hold the Reset Switch in (see page 5).
3. While holding the Reset Switch in, power the switch back on.

This causes the switch to use the original factory installed main firmware version. Once the switch is operational, you can try upgrading the main firmware again.

## Backup/Restore

Selecting *Backup/Restore* on the menu bar gives you the ability to back up the switch's configuration and user profile information:

**Station List**

Energy Box Name	Filename
[PE4104G]	Please select a file to restore ▼

**Backup**

Password:

**Restore**

Auto Mapping

Password:

Filename:

### Station List

Station List lists the PE4104G only.

### Backup

To backup the device's settings do the following:

1. In the *Password* field, key in a password for the file.

---

**Note:** Entering a password is optional. If you do enter a password, make a note of it, since you will need it to be able to restore the file.

---

2. Click **Save**.
3. When the browser asks what you want to do with the file, select *Save to disk*; then save it in a convenient location.

## Restore

To restore a previous backup, do the following:

1. Click **Browse**; navigate to the file and select it.

---

**Note:** If you renamed the file, you can leave the new name. There is no need to return it to its original name.

---

2. In the *Password* field, key in the same password that you used to save the file.

---

**Note:** If you did not set a password when you created the backup file, you can omit this step.

---

3. Select as many of the options that are presented as you wish to restore.
4. Click **Restore**.

After the file is restored, a message appears to inform you that the procedure succeeded.

# Chapter 5

## Telnet Commands

### Remote Terminal Operations

---

With ATEN PE4104G you can log in remotely from a computer using Telnet interface that allows system control through a high-end controller or PC.

#### Telnet

Telnet is a program that connects to a device over a network to provide text-based management and control. Telnet provides some of the same management features found in the PE4104G's web GUI. You can reference the PE4104G's web GUI functions by downloading the user manual from our website ([www.aten.com](http://www.aten.com)). This can help you as you work your way through the text-based commands used to control the eco PDU that are discussed in this guide.

Telnet is available on all eco PDUs installed with the latest firmware. You can log in to the PE4104G via Telnet from any computer connected to the same network.

#### Setup

Log in to the PE4104G's web GUI, go to the **Setup** tab and click **Security** from the menu bar. Under **Working Mode**, check *Enable Telnet Server* and then click **Save** at the bottom of the page.

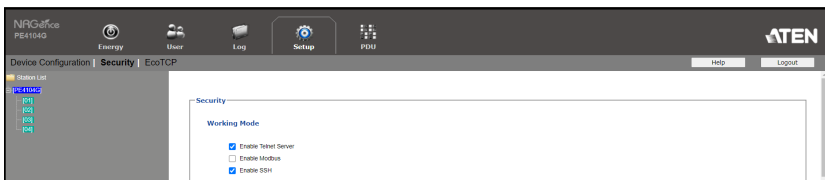

---

**Note:** If the *Enable Telnet Server* option is not available, please download the latest firmware from our website.

---

#### Logging In

To log in to the PE4104G via Telnet, do the following:

1. On your computer, open the start menu and select **Run**. Type: `cmd`

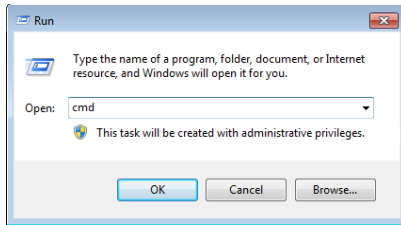

Click **OK**.

- At the command prompt, key in *telnet* and the IP Address of the PDU, as follows:

```
telnet [IP Address]
```

- Press **Enter**. The login screen appears:

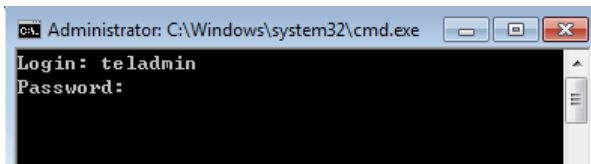

- At the login prompt, enter Username: **teladmin**; and Password: **telpwd**.

---

**Note:** The Telnet username and password can be configured on the User tab of the PE4104G's web GUI.

---

- When the Telnet session is established, *Logged in successfully* appears along with the command line prompt:

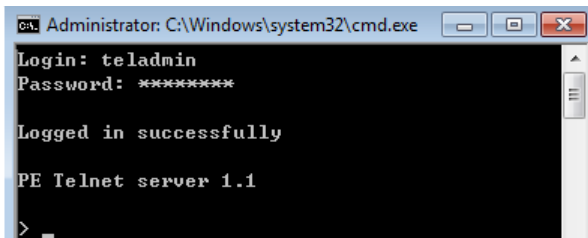

## **Session Timeout**

A live Telnet connection would be terminated if there is no incoming data with 60 Seconds.

## Commands

---

Use the Telnet commands to view and configure the PE4104G as described in each section. The text-based command line provides some of the same functions found under the Energy tab of the PE4104G's web-based GUI. Commands to view and configure the PE4104G are provide in the following sections. You can reference information provided in the user manual for the functions as you use the commands.

### Verification

After sending an incorrect command, a verification message appears at the end of the command line.

- ◆ **Invalid command or exceed max command length** - the command has the wrong format and/or values. Try typing in the command string again using the correct format and/or values.

## **Read Power Outlet Status**

The Read Power Outlet Status command allows you to view the power status of an outlet on the PE4104G.

The formula for Read Outlet Status commands is as follows:

**Command + Outlet + Number + Option + [Enter]**

1. For example, if you want to read the status of outlet 01 with a simple return string, type the following:

**read status o01 simple [Enter]**

2. For example, if you want to read the status of outlet 12 with a format return string, type the following:

**read status o12 format [Enter]**

The following tables show the possible values for the Read Outlet Status commands:

<b>Command</b>	<b>Description</b>
read status	Read status command

<b>Outlet</b>	<b>Description</b>
o	Outlet command
xx	PDU Outlet number xx: Outlet on PDU (01 ~ 04) Example: o02

<b>Option</b>	<b>Description</b>
simple	Return simple string of the selected power outlet status
format	Return format string of the selected power outlet status

The following table lists the available Read Outlet Status commands:

<b>Command</b>	<b>Outlet</b>	<b>Option</b>	<b>Enter</b>	<b>Description</b>
read status	oXX	simple	[Enter]	Read the status of outlet XX with a simple return string. XX: Outlet number (01 ~ 04)
read status	oXX	format	[Enter]	Read the status of outlet XX with a format return string. XX: Outlet number (01 ~ 04)

**Note:** 1. Each command string can be separated with a space.

2. The **Option** command string can be skipped and **format** will be used by default.



## **Switch Outlet Status**

The Switch Outlet Status command allows you to change the power status of an outlet on the PE4104G.

The formula for Switch Outlet Status commands is as follows:

**Command + Outlet + Number + Option + Control + [Enter]**

1. For example, if you want to switch off outlet 04 immediately, type the following:  
**sw o04 imme off [Enter]**
2. For example, if you want to switch on outlet 01 with the time delay set for the outlet, type the following:  
**sw o01 delay on [Enter]**
3. For example, if you want to reboot outlet 03, type the following:  
**sw o03 reboot [Enter]**

The following tables show the possible values for the Switch Outlet Status commands:

Command	Description
sw	Switch outlet status command
Outlet	Description
o	Outlet command
xx	PDU Outlet number xx: Outlet on PDU (01 ~ 04) Example: o02
Option	Description
imme	Switch outlet status immediately
delay	Switch outlet status with pre-configured delay time
Control	Description
on	Switch outlet on
off	Switch outlet off
reboot	Switch outlet off and then switch outlet on

The following table lists the available Switch Outlet Status commands:

Command	Outlet	Option	Control	Enter	Description
sw	oXX	imme delay	on	[Enter]	Switch outlet XX on with option imme or delay. XX: Outlet number (01 ~ 04)
sw	oXX	imme delay	off	[Enter]	Switch outlet XX off with option imme or delay. XX: Outlet number (01 ~ 04)
sw	oXX		reboot	[Enter]	Switch outlet XX off and on. XX: Outlet number (01 ~ 04)

- 
- Note:** 1. Each command string can be separated with a space.
2. The **Option** command string can be skipped and **delay** will be used by default.
-

## **Read Environmental Value**

The Read Environmental Value command allows you to view measurements from the PE4104G's environmental sensors.

The formula for Read Environmental Value commands is as follows:

**Command + Outlet + Number + Option + [Enter]**

1. For example, if you want to read environmental sensor 02 with a simple return string, type the following:

**read sensor o02 simple [Enter]**

2. For example, if you want to read environmental sensor 01 with a format return sting, type the following:

**read sensor o01 format [Enter]**

The following tables show the possible values for the Read Environmental Value commands:

<b>Command</b>	<b>Description</b>
read sensor	Read environmental sensor value command.

<b>Outlet</b>	<b>Description</b>
o	Outlet with environmental sensor installed command
xx	PDU Outlet number with environmental sensor installed xx: Outlet on PDU (01 ~ 04) Example: o02

<b>Option</b>	<b>Description</b>
simple	Return simple string of the environmental sensor value on the selected power outlet with environmental sensor installed.
format	Return format string of the environmental sensor value on the selected power outlet with environmental sensor installed.

The following table lists the available Read Environmental Value commands:

Command	Sensor	Option	Enter	Description
read sensor	oXX	simple format	[Enter]	Read the environmental sensor value on the selected power outlet with environmental sensor installed. Outlet XX with option simple or format. XX: Outlet number (01 ~ 04).

**Note:** 1. Each command string can be separated with a space.

2. The **Option** command string can be skipped and **format** will be used by default.

### Close Telnet Session

The Close Telnet Session command allows you to disconnect the telnet session from the PE4104G.

The formula for the Close Telnet Session command is as follows:

**Command + [Enter]**

1. For example, if you want to disconnect the telnet session, type the following:

**quit [Enter]**

The following table shows the value for the Close Telnet Session command:

Command	Description
quit	Close telnet session command

The following table lists the Close Telnet Session command:

Command	Enter	Description
quit	[Enter]	Disconnects telnet session with PE4104G.

## **Reboot PDU Device**

The Reboot PDU Device command allows you to reboot the PE4104G.

The formula for Reboot PDU Device commands is as follows:

**Command + [Enter]**

- For example, if you want to reboot the PE4104G, type the following:

**reboot [Enter]**

The following tables show the possible values for the Read Environmental Value commands:

Command	Description
reboot	Reboot PDU device command

The following table lists the available Reboot PDU Device command:

Command	Enter	Description
reboot	[Enter]	Reboots the PE4104G.

## **Reset All PDU Config to Default Value**

The Reset All PDU Config to Default Value command allows you to reset the PE4104G to the default factory settings.

The formula for Reset All PDU Config to Default Value commands is as follows:

**Command + [Enter]**

- For example, if you want to reset the PE4104G, type the following:

**clearallsetting [Enter]**

The following tables show the possible values for the Reset All PDU Config to Default Value commands:

Command	Description
clearallsetting	Reset all PDU configuration to default value command

The following table lists the available Reset All PDU Config to Default Value command:

Command	Enter	Description
clearallsetting	[Enter]	Resets the PE4104G to default factory settings.

This Page Intentionally Left Blank

## Safety Instructions

---

### General

- ◆ This product is for indoor use only.
- ◆ Read all of these instructions. Save them for future reference.
- ◆ Follow all warnings and instructions marked on the device.
- ◆ Do not place the device on any unstable surface (cart, stand, table, etc.). If the device falls, serious damage will result.
- ◆ Do not use the device near water.
- ◆ Do not place the device near, or over, radiators or heat registers.
- ◆ The device cabinet is provided with slots and openings to allow for adequate ventilation. To ensure reliable operation, and to protect against overheating, these openings must never be blocked or covered.
- ◆ The device should never be placed on a soft surface (bed, sofa, rug, etc.) as this will block its ventilation openings. Likewise, the device should not be placed in a built in enclosure unless adequate ventilation has been provided.
- ◆ Never spill liquid of any kind on the device.
- ◆ Unplug the device from the wall outlet before cleaning. Do not use liquid or aerosol cleaners. Use a damp cloth for cleaning.
- ◆ The device should be operated from the type of power source indicated on the marking label. If you are not sure of the type of power available, consult your dealer or local power company.
- ◆ The device is designed for IT power distribution systems with 100V to 230V phase-to-phase voltage.
- ◆ To prevent damage to your installation it is important that all devices are properly grounded.
- ◆ Do not allow anything to rest on the power cord or cables. Route the power cord and cables so that they cannot be stepped on or tripped over.
- ◆ The device is equipped with a 3-wire grounding type plug. This is a safety feature. If you are unable to insert the plug into the outlet, contact your electrician to replace your obsolete outlet. Do not attempt to defeat the purpose of the grounding-type plug. Always follow your local/national wiring codes.

- ◆ If an extension cord is used with this device make sure that the total of the ampere ratings of all products used on this cord does not exceed the extension cord ampere rating. Make sure that the total of all products plugged into the wall outlet does not exceed 15 amperes.
- ◆ To help protect your system from sudden, transient increases and decreases in electrical power, use a surge suppressor, line conditioner, or uninterruptible power supply (UPS).
- ◆ Position system cables and power cables carefully; Be sure that nothing rests on any cables.
- ◆ Never push objects of any kind into or through cabinet slots. They may touch dangerous voltage points or short out parts resulting in a risk of fire or electrical shock.
- ◆ Do not attempt to service the device yourself. Refer all servicing to qualified service personnel.
- ◆ If the following conditions occur, unplug the device from the wall outlet and bring it to qualified service personnel for repair.
  - ◆ The power cord or plug has become damaged or frayed.
  - ◆ Liquid has been spilled into the device.
  - ◆ The device has been exposed to rain or water.
  - ◆ The device has been dropped, or the cabinet has been damaged.
  - ◆ The device exhibits a distinct change in performance, indicating a need for service.
  - ◆ The device does not operate normally when the operating instructions are followed.
- ◆ Only adjust those controls that are covered in the operating instructions. Improper adjustment of other controls may result in damage that will require extensive work by a qualified technician to repair.
- ◆ Do not connect the RJ-11 connector marked “UPGRADE” to a public telecommunication network.



## **Rack Mounting**

- ◆ Before working on the rack, make sure that the stabilizers are secured to the rack, extended to the floor, and that the full weight of the rack rests on the floor. Install front and side stabilizers on a single rack or front stabilizers for joined multiple racks before working on the rack.
- ◆ Always load the rack from the bottom up, and load the heaviest item in the rack first.
- ◆ Make sure that the rack is level and stable before extending a device from the rack.
- ◆ Do not overload the AC supply branch circuit that provides power to the rack. The total rack load should not exceed 80 percent of the branch circuit rating.
- ◆ Make sure that all equipment used on the rack – including power strips and other electrical connectors – is properly grounded.
- ◆ Ensure that proper airflow is provided to devices in the rack.
- ◆ Ensure that the operating ambient temperature of the rack environment does not exceed the maximum ambient temperature specified for the equipment by the manufacturer.
- ◆ Do not step on or stand on any device when servicing other devices in a rack.

## Technical Support

---

### International

- ◆ For online technical support – including troubleshooting, documentation, and software updates: **<http://support.aten.com>**
- ◆ For telephone support, see *Telephone Support*, page v

### North America

Email Support		<a href="mailto:support@aten-usa.com">support@aten-usa.com</a>
Online Technical Support	Troubleshooting Documentation Software Updates	<a href="http://www.aten-usa.com/support">http://www.aten-usa.com/support</a>
Telephone Support		1-888-999-ATEN ext 4988 1-949-428-1111

When you contact us, please have the following information ready beforehand:

- ◆ Product model number, serial number, and date of purchase.
- ◆ Your computer configuration, including operating system, revision level, expansion cards, and software.
- ◆ Any error messages displayed at the time the error occurred.
- ◆ The sequence of operations that led up to the error.
- ◆ Any other information you feel may be of help.

## IP Address Determination

If you are an administrator logging in for the first time, you need to access the eco PDU in order to give it an IP address that users can connect to. There are two methods to choose from. In each case, your client computer must be on the same network segment as the eco PDU. After you have connected and logged in you can give the device its fixed network address. (See *Event Notification*, page 34.)

### Method 1:

For computers running Windows, an IP address can be determined and/or assigned with the IP Installer utility. The utility can be obtained from the *Download* area of our web site or from the software CD. Look under *Driver/SW*, and the model of your device. After downloading the utility to your computer, do the following:

1. Unzip the contents of *IPInstaller.zip* to a directory on your hard drive.
2. Go to the directory that you unzipped the IPInstaller program to and run *IPInstaller.exe*. A dialog box similar to the one below appears:

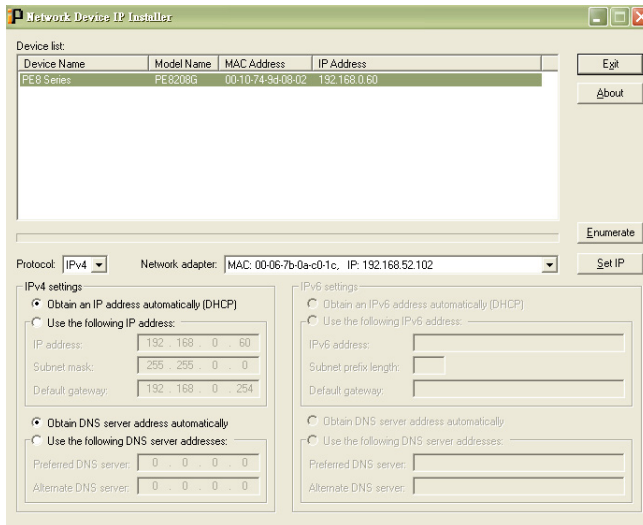

(Continues on next page.)

(Continued from previous page.)

3. Select the device in the *Device List*.

---

**Note:** 1. If the list is empty, or your device doesn't appear, click **Enumerate** to refresh the Device List.

2. If there is more than one device in the list, use the MAC address to pick the one you want. The eco PDU's MAC address is located on its bottom panel.
- 

4. Select either *Obtain an IP address automatically (DHCP)*, or *Specify an IP address*. If you chose the latter, fill the IP Address, Subnet Mask, and Gateway fields with the information appropriate to your network.
5. Click **Set IP**.
6. After the IP address shows up in the Device List, click **Exit** to end the program.

### **Method 2:**

1. Set your computer's IP address to 192.168.0.XXX  
Where XXX represents any number or numbers except 60. (192.168.0.60) is the default address of the eco PDU.)
2. Specify the device's default IP address (192.168.0.60) in your browser, and you will be able to connect.
3. Assign a fixed IP address for the device (see *IPv4 Configuration*, page 33), that is suitable for the network segment that it resides on.
4. After you log out, reset your computer's IP address to its original value.
5. Once you have logged in, go to Network Settings to set up the permanent IP environment (see *IPv4 Configuration*, page 33).

### **Method 3:**

eco DC allows you to determine/assign an IP address in order to configure a PDU device and monitor power status of the equipment connected to it. eco DC can be obtained from the Download area of the ATEN web site.

# Specifications

## PE4104G

Models		PE4104G
<b>Outlet</b>		4 x IEC C13
<b>Inlet</b>		IEC C14
<b>LAN Port</b>		1 x RJ-45 Female with LEDs (Silver / LED: Orange / Green) 10/100M
<b>LED</b>	<b>Outlet</b>	4 x Green
	<b>Power</b>	1 x Orange
	<b>Sensor</b>	1 x Orange
<b>Buttons</b>	<b>Reset</b>	1 x Semi-recessed Pushbutton
	<b>Select</b>	4 x Select Pushbuttons
<b>Sensor Port</b>		1 x RJ11
<b>Door Sensor</b>		1 x Phoenix Connector +12V (D1+/D1-/12V/G)
<b>Electrical</b>		
Nominal Input Voltage		100–240 VAC
Maximum Input Current		10A Max
Input Frequency		50–60Hz
Input Connection		IEC C14
Input Power		2400VA Max
Outlet Type		(4) IEC C13
Normal Output Voltage		100–240 VAC
Maximum Output Current (Outlet)		10A Max
Maximum Output Current (Bank)		10A Max
Maximum Output Current (Total)		10A Max
Breakers		Yes (UL1077)
Metering		No
Outlet Switching		Yes
<b>Power Consumption</b>		AC110V:3.1W:20BTU AC220V:3.5W:22BTU
<b>Physical Properties</b>		

Housing	Metal
Dimensions (W x Dx H)	4.40 X 11.50 X 20.00 cm (1.73 x 4.53 x 7.87 in.)
Weight	0.90 kg (1.98 lb)
Power Cord Length	3 m
<b>Environmental</b>	
Temperature (Operating / Storage)	0–50°C / –20–60°C
Humidity (Operating / Storage)	0–80°C RH, Non-Condensing
<b>Compliance</b>	
EMC Verification	CE-EMC
Safety Verification	CE-LVD

## Administrator Login Failure

---

If you are unable to perform an Administrator login (because the Username and Password information has become corrupted, or you have forgotten it, for example), you can clear the login information with the following procedure:

1. Power off the PE4104G and remove its housing.
2. Short the jumper labeled J4 (PIN1 and PIN2).

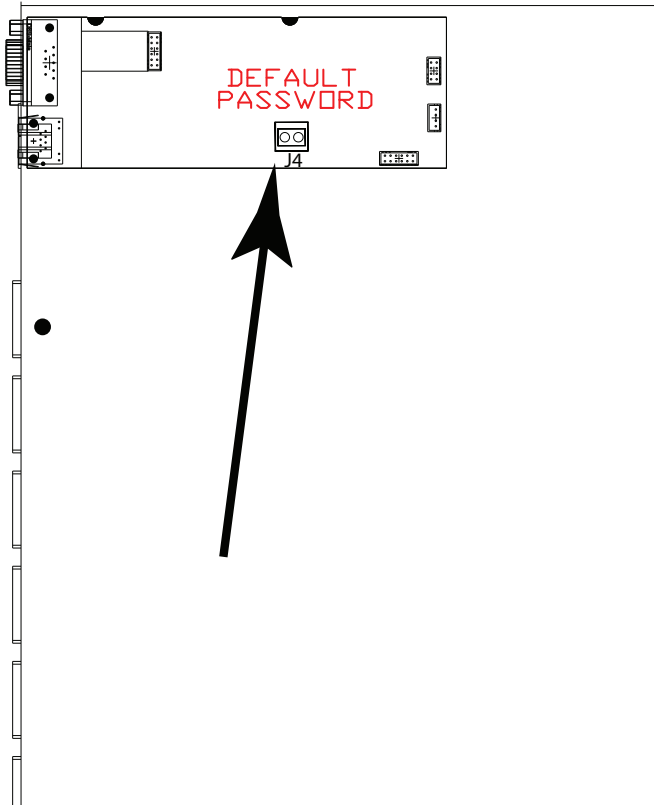

3. Power on the PE4104G.
4. When the 2-digit, 7-segment display shows "00", power off the switch.
5. Remove the jumper cap from J4.
6. Close the housing and start the PE4104G.  
After you start, you can use the default Username and Password to log in.

## Limited Warranty

---

ATEN warrants its hardware in the country of purchase against flaws in materials and workmanship for a Warranty Period of two [2] years (warranty period may vary in certain regions/countries) commencing on the date of original purchase. This warranty period includes the [LCD panel of ATEN LCD KVM switches](#). Select products are warranted for an additional year (see [A+ Warranty](#) for further details). Cables and accessories are not covered by the Standard Warranty.

### What is covered by the Limited Hardware Warranty

ATEN will provide a repair service, without charge, during the Warranty Period. If a product is defective, ATEN will, at its discretion, have the option to (1) repair said product with new or repaired components, or (2) replace the entire product with an identical product or with a similar product which fulfills the same function as the defective product. Replaced products assume the warranty of the original product for the remaining period or a period of 90 days, whichever is longer. When the products or components are replaced, the replacing articles shall become customer property and the replaced articles shall become the property of ATEN.

To learn more about our warranty policies, please visit our website:  
<http://www.aten.com/global/en/legal/policies/warranty-policy/>

© Copyright 2021 ATEN® International Co., Ltd.  
Released: 2021-05-25

ATEN and the ATEN logo are registered trademarks of ATEN International Co., Ltd. All rights reserved. All other brand names and trademarks are the registered property of their respective owners.