



**DVI KVM Over IP Extender
KE6900 / KE6940 / Matrix Manager
User Manual**



EMC Information

FEDERAL COMMUNICATIONS COMMISSION INTERFERENCE

STATEMENT: This equipment has been tested and found to comply with the limits for a Class A digital device, pursuant to Part 15 of the FCC Rules. These limits are designed to provide reasonable protection against harmful interference when the equipment is operated in a commercial environment. This equipment generates, uses, and can radiate radio frequency energy and, if not installed and used in accordance with the instruction manual, may cause harmful interference to radio communications. Operation of this equipment in a residential area is likely to cause harmful interference in which case the user will be required to correct the interference at his own expense.

The device complies with Part 15 of the FCC Rules. Operation is subject to the following two conditions: (1) this device may not cause harmful interference, and (2) this device must accept any interference received, including interference that may cause undesired operation.

FCC Caution: Any changes or modifications not expressly approved by the party responsible for compliance could void the user's authority to operate this equipment.

CE Warning: This is a class A product. In a domestic environment this product may cause radio interference in which case the user may be required to take adequate measures.

Suggestion: Shielded twisted pair (STP) cables must be used with the unit to ensure compliance with FCC & CE standards.

KCC Statement

유선 제품용 / A 급 기기 (업무용 방송 통신 기기)
이 기기는 업무용 (A 급) 전자파적합기기로서 판매자 또는 사용자는 이 점을 주의하시기 바라며, 가정 외의 지역에서 사용하는 것을 목적으로 합니다.



RoHS

This product is RoHS compliant.

SJ/T 11364-2006

The following contains information that relates to China.

部件名称	有毒有害物质或元素					
	铅	汞	镉	六价铬	多溴联苯	多溴二苯醚
电器部件	●	○	○	○	○	○
机构部件	○	○	○	○	○	○

- : 表示该有毒有害物质在该部件所有均质材料中的含量均在SJ/T 11363-2006规定的限量要求之下。
- : 表示符合欧盟的豁免条款，但该有毒有害物质至少在该部件的某一均质材料中的含量超出SJ/T 11363-2006的限量要求。
- ×: 表示该有毒有害物质至少在该部件的某一均质材料中的含量超出SJ/T 11363-2006的限量要求。

User Information

Online Registration

Be sure to register your product at our online support center:

International	http://eservice.aten.com
---------------	---

Telephone Support

For telephone support, call this number:

International	886-2-8692-6959
China	86-10-5255-0110
Japan	81-3-5615-5811
Korea	82-2-467-6789
North America	1-888-999-ATEN ext 4988
United Kingdom	44-8-4481-58923

User Notice

All information, documentation, and specifications contained in this manual are subject to change without prior notification by the manufacturer. The manufacturer makes no representations or warranties, either expressed or implied, with respect to the contents hereof and specifically disclaims any warranties as to merchantability or fitness for any particular purpose. Any of the manufacturer's software described in this manual is sold or licensed *as is*. Should the programs prove defective following their purchase, the buyer (and not the manufacturer, its distributor, or its dealer), assumes the entire cost of all necessary servicing, repair and any incidental or consequential damages resulting from any defect in the software.

The manufacturer of this system is not responsible for any radio and/or TV interference caused by unauthorized modifications to this device. It is the responsibility of the user to correct such interference.

The manufacturer is not responsible for any damage incurred in the operation of this system if the correct operational voltage setting was not selected prior to operation. PLEASE VERIFY THAT THE VOLTAGE SETTING IS CORRECT BEFORE USE.

Package Contents

Basic Package

The basic KE6900 / KE6940 package consists of:

- 1 KE6900T / KE6940T DVI KVM Over IP Extender
- 1 KE6900R / KE6940R DVI KVM Over IP Extender
- 2 Power Adapters
- 1 USB DVI-D KVM Cable (KE6900T/KE6940T only)
- 1 DVI-D Cable 2 m (KE6940T only)
- 1 Mounting Kits
- 1 User Instructions*

Check to make sure that all of the components are present and in good order. If anything is missing, or was damaged in shipping, contact your dealer.

Read this manual thoroughly and follow the installation and operation procedures carefully to prevent any damage to the KE6900 / KE6940 or to any other devices on the installation.

* Features may have been added to the KE6900 / KE6940 since this manual was published. Please visit our website to download the most up-to-date version.

Copyright © 2016 ATEN® International Co., Ltd.

Manual Date: 2016-06-01

Altusen and the Altusen logo are registered trademarks of ATEN International Co., Ltd. All rights reserved. All other brand names and trademarks are the registered property of their respective owners.

Contents

EMC Information	ii
SJ/T 11364-2006	iii
User Information	iv
Online Registration	iv
Telephone Support	iv
User Notice	iv
Package Contents	v
Basic Package	v
About This Manual	xii
Conventions	xiv
Product Information	xiv

Chapter 1.

Introduction

Overview	1
Features	2
Requirements	3
Console	3
Computers	3
Cables	3
Software	3
Operating Systems	4
Components	5
KE6900T (Transmitter) Front View	5
KE6900T (Transmitter) Rear View	6
KE6900R (Receiver) Front View	7
KE6900R (Receiver) Rear View	8
KE6940T (Transmitter) Front View	9
KE6940T (Transmitter) Rear View	10
KE6940R (Receiver) Front View	11
KE6940R (Receiver) Rear View	12

Chapter 2.

Hardware Setup

Rack Mounting	13
Wall Mounting	15
Setting Up a Point-to-Point Installation	16
Point-to-Point Installation 1 of 2	17
Point-to-Point Installation 2 of 2	18
Setting Up a LAN Installation	19
Network Installation Diagram 1 of 2	21
Network Installation Diagram 2 of 2	22
Network Configuration	23
Exit OSD	24

Default IP Addresses	24
KE6900 I/O Ports	25

Chapter 3.

OSD Operation

Overview	27
LED Display	27
Invoking the OSD	28
Microphone Hotkey	28
Touch Screen Calibration	28
OSD Interface	29
User Station Configuration	30
Network	30
Properties	31
System	33
Transmitter Configuration	34
Network	34
Properties	35
System	38
User Preferences	39
Connecting	40
Connections Page	41
List Mode	41
Array Mode	43
Profile / Video Wall Page	44

Chapter 4.

Matrix Manager Software Installation

Overview	47
Download - Trial Version	47
Matrix Manager Install	49
Upgrading Trial Version	52

Chapter 5.

Browser / Telnet Operation

Overview	53
Logging In	53
The Matrix Manager Main Page	54
Web Components	54
Tree View Considerations	55
The Tab Bar	56
Telnet	57
Configuration Menu	57
Main Menu	57
1. Network	58
2. Properties	58

3. System 59

Chapter 6.

Dashboard

Overview 61

 Active Connections 62

 Active Sessions 63

 Online User Stations 64

 Online Transmitters 65

 Latest Events 66

 Schedule 67

Chapter 7.

Device Management

Overview 69

User Stations 70

 Adding a User Station 71

Configuring a User Station 72

 Deleting a User Station 76

User Station Video Group 77

 Hardware Setup 77

 Adding a User Station Video Group 78

Transmitters 80

 Adding a Transmitter 81

Configuring a Transmitter 82

 Deleting a Transmitter 86

Channel Connections 87

Channels 88

 Adding a Channel 89

Channel Groups 92

 Adding a Channel Group 92

Profiles 94

 Adding a Profile 95

Video Wall 98

 Video Wall Example 99

 Adding a Video Wall 100

Chapter 8.

User Management

Overview 105

Users 106

 Adding Users 106

 Modifying User Accounts 108

 Deleting User Accounts 108

Groups 109

 Creating Groups 109

Modifying Groups	110
Deleting Groups	110
Users and Groups	111
Assigning Users to a Group From the User's Notebook	111
Removing Users From a Group From the User's Notebook	112
Assigning Users to a Group From the Group's Notebook	113
Removing Users From a Group From the Group's Notebook	114
Device	115
Assigning Device Permissions From the User's Notebook	115
Assigning Device Permissions From the Groups' Notebook	117
Profiles/Video Walls	118
Assigning Profile/Video Wall Permissions From the User's Notebook ..	118

Chapter 9.

System

Overview	120
Global Settings	121
ANMS	124
Event Destination	124
Authentication & Authorization	126
Redundancy	129

Chapter 10.

Logs

Overview	133
System Log	134
Filter	136

Chapter 11.

Maintenance

Overview	137
Backup / Restore	138
Backup	139
Restore	139
Firmware Upgrade	140
Firmware Upgrade Recovery	141
Certificates	142
Private Certificate	142
Certificate Signing Request	143
Preferences	145

Chapter 12.

Firmware Upgrade Utility

Preparation	147
Starting the Upgrade	148

Upgrade Succeeded	150
Firmware Upgrade Recovery	151

Chapter 13.

RS-232 Commands

Serial Control Protocol Commands	153
Configuring the Serial Port	153
Device/Profile Commands.	153
Verification	153
Switch Port Command	154
Mute Command.	158
Profile Command	160
EDID Command	162
Reset Command.	164
RS-232 Command	165
OSD Command.	168
List Command.	169
Read Command	171
Set Command.	175

Appendix

Safety Instructions	183
General	183
Rack Mounting	185
Technical Support.	186
International	186
North America	186
Specifications	187
Optional Rack Mounting	189
Dual Rack Mounting	189
Single Rack Mounting	192
IP Installer.	194
Trusted Certificates.	195
Overview.	195
Self-Signed Private Certificates	196
Examples	196
Importing the Files.	196
RS-232 Pin Assignments	197
Transmitter Front RS-232 Port	197
Multicast IP Address.	198
KE Multicast Rule	198
Multicast IP Formula	198
If X is between 0 ~ 127	198
If X is between 128 ~ 192	199
If X is 192 or higher	199
Keys to Network Performance	200

- Build a Network Diagram 200
 - Other Factors 200
- Choose a High Performance Switch 202
 - Layer 2 or Layer 3 Switches 202
- Considerations 202
 - Number of ports 202
 - Stackable verse Standalone 202
 - What Stackable Switches Can do: 203
 - Switch Specifications 203
- Configuring Switches and KE Devices 204
 - KE transmitter Settings: 204
- Limited Warranty 205

About This Manual

This User Manual is provided to help you get the most from your KE6900 / KE6940 system. It covers all aspects of installation, configuration and operation. An overview of the information found in the manual is provided below.

Chapter 1, Introduction, introduces you to the KE6900 / KE6940 System. Its purpose, features and benefits are presented, and its front and back panel components are described.

Chapter 2, Hardware Setup, provides step-by-step instructions for setting up your installation, and explains some basic operation procedures.

Chapter 3, OSD Operation, explains the fundamental concepts involved in operating the KE6900 / KE6940 system, and provides a complete description of the On Screen Displays (OSDs) and how to work with them.

Chapter 4, Matrix Manager Software Installation, explains the administrative procedures that are required to download and install the Matrix Manager software.

Chapter 5, Browser / Telnet Operation, explains how to log in to the Matrix Manager with a web browser, and describes the features, functions, and how to work with the browser's interface.

Chapter 6, Dashboard, explains how to use the Matrix Manager's Dashboard tab to view connection, session, and device events.

Chapter 7, Device Management, explains how to add, configure, and organize the Transmitter and Receiver devices that will be managed over the network, as well as how to create Channels and Profiles for matrix connections.

Chapter 8, User Management, describes how to add, modify and delete user accounts; create user groups and assign users to them; specify access rights for users and groups; and specify user authentication.

Chapter 9, System, explains the Matrix Manager's global settings, and ANMS settings for LDAP/AD, RADIUS, and TACACS+ authentication and authorization.

Chapter 10, Logs, explains how to access, filter, and search the various logs that are kept by the Matrix Manager.

Chapter 11, Maintenance, explains how to use the Matrix Manager's Maintenance tab to backup, restore, upgrade firmware, install certificates, and set user preferences.

Chapter 12, Firmware Upgrade Utility, explains how to download and use the Firmware Upgrade Utility to install new firmware on the devices.

Chapter 13, RS-232 Commands, provides a complete list of the serial control protocol commands used when utilizing the RS-232 Serial Port so that an extra source device can be utilized in the installation.

An Appendix, at the end of the manual provides technical and troubleshooting information.

Conventions

This manual uses the following conventions:

- Monospaced Indicates text that you should key in.
- [] Indicates keys you should press. For example, [Enter] means to press the **Enter** key. If keys need to be chorded, they appear together in the same bracket with a plus sign between them: [Ctrl+Alt].
1. Numbered lists represent procedures with sequential steps.
- ◆ Bullet lists provide information, but do not involve sequential steps.
- Indicates selecting the option (on a menu or dialog box, for example), that comes next. For example, Start → Run means to open the *Start* menu, and then select *Run*.
-  Indicates critical information.

Product Information

For information about all ALTUSEN products and how they can help you connect without limits, visit ALTUSEN on the Web or contact an ALTUSEN Authorized Reseller. Visit ALTUSEN on the Web for a list of locations and telephone numbers:

International	http://www.aten.com
North America	http://www.aten-usa.com

Chapter 1

Introduction

Overview

The KE6900 / KE6940 DVI KVM Over IP Extender is an IP based matrix extender that allows access to a computer system from a remote USB KVM console anywhere over a LAN. The KE6900 series is a single view extender that supports one DVI display at each end. The KE6940 series is a dual view extender that supports two DVI displays at each end, allowing the video output to display across two monitors.

The KE6900 / KE6940 consists of a transmitter that connects to the computer and a receiver that provides console access from a separate location. The computer is accessed from the remote console via a standard TCP/IP network or direct Ethernet cable connection. This is perfect for any installation where you need to place the console where it is convenient, but you want the computer to reside in a secure location - away from the keyboard, mouse and display.

As a matrix extender it can connect one or more: computers-to-consoles in several ways: one-to-one (Extender mode), one-to-many (Splitter mode), many-to-one (Switch mode), or many-to-many (Matrix mode).

The KE6900 / KE6940 has a local On Screen Display (OSD) on the receiver to configure both units - for easy setup and operation. Using the transmitter and receiver over a standard TCP/IP network (optional) via Cat 5e/6 cable allows point-to-point, point-to-multipoint, and multipoint-to-multipoint administration without needing a KVM switch. Both the transmitter and receiver have RS-232 ports to connect to a serial terminal for configuration or serial devices such as touchscreens and barcode scanners.

The Matrix Manager® software provides advanced features for username and password authentication, auto-detection of devices on the same LAN segment, management of devices, and setup of Splitter, Switch, and Matrix modes. New security features also provide extra protection with remote login security, a username and password can be required when the receiver connects to the transmitter.

With the OSD, network access, RS-232 port, software administration, and Auto MDIX, the KE6900 / KE6940 is the most cost-effective and convenient way to get a full digital extension from anywhere on the LAN.

Features

- ◆ Remote KVM console access of computers over LAN or Ethernet cable connection
- ◆ Dual console operation – control your system from both the Transmitter and Receiver by USB keyboard, monitor, and mouse
- ◆ RS-232 serial ports allows you to connect to a serial terminal for configuration, and serial devices such as touchscreens and barcode scanners¹
- ◆ Superior video quality – up to 1920 x 1200 @ 60 Hz; 24-bit color depth
- ◆ Supports standard VGA resolutions from 640 x 480 to 1920 x 1200 at 60Hz
- ◆ OSD (On Screen Display) on the Receiver configures both units
- ◆ Supports Matrix Manager Web GUI administration²
- ◆ Matrix Manager Lite provides web GUI support for smaller installations³
- ◆ Remote login security
- ◆ DVI digital and analog monitor support
- ◆ Built-in ESD protection and surge protection
- ◆ Supports stereo speakers and microphone
- ◆ Auto-MDIX - automatically detects cable type
- ◆ Supports widescreen formats
- ◆ Supports High-Quality Video streaming
- ◆ Virtual Media Support
- ◆ Hot pluggable
- ◆ Rack Mountable
- ◆ Upgradeable firmware

Note: 1. RS-232 serial ports support Tx/Rx/CTS/RTS/DTR/DSR signals only.

2. The Matrix Manager web GUI can be updated from the CCKM page on our website: www.aten.com. To obtain a license for the full version of the software please contact your ATEN dealer.

3. The Matrix Manager Lite is a web GUI that supports up to 8 KE devices and can be downloaded for free after registering your product on the ATEN eService website (<http://eservice.aten.com>).

Requirements

Console

- ◆ (KE6900) One DVI compatible monitors capable of the highest possible resolution
- ◆ (KE6940) Two DVI compatible monitors capable of the highest possible resolution
- ◆ A USB mouse
- ◆ A USB keyboard
- ◆ Microphone and speakers

Computers

The following equipment must be installed on each computer that is to be connected to the system:

- ◆ (KE6900) One DVI port
- ◆ (KE6940) Two DVI ports
- ◆ USB Type A port
- ◆ Audio ports

Cables

- ◆ For optimal signal integrity and to simplify the setup, we strongly recommend that you only use the high quality custom USB KVM Cable that is provided with this package.

Software

The minimum hardware and software requirements for the computer running the Matrix Manager software are:

- ◆ Processor: Intel or AMD processor 1 GHz or above
- ◆ RAM: 2GB or above
- ◆ HDD: 16GB or above
- ◆ Web browser
- ◆ Java Runtime Environment (JRE) 6 with update 11 or higher
- ◆ Operating System Requirements:
 - ◆ Windows 2000, XP, Vista, 2003, 2008, 7 and 8.1
 - ◆ Linux (Ubuntu, CentOS, Fedora, SUSE)

Operating Systems

The KE69x0 supports the following operating systems which can display standard DVI/VGA signals:

OS		Version
Windows		2000 and higher
Linux	RedHat	6.0 and higher
	SUSE	8.2 and higher
	Mandriva (Mandrake)	9.0 and higher
UNIX	AIX	4.3 and higher
	FreeBSD	3.51 and higher
	Sun	Solaris 8 and higher
Novell	Netware	5.0 and higher
Mac		OS 9 and higher

Components

KE6900T (Transmitter) Front View

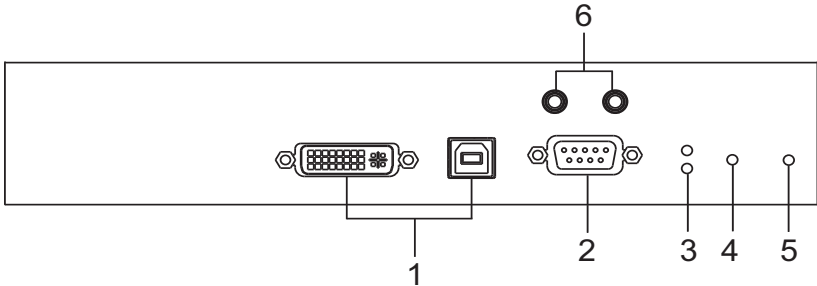

No.	Component	Description
1	KVM Ports	The USB KVM cable supplied with the package that links the Transmitter to the computer plugs into these ports.
2	RS-232 Port	This RS-232 serial port is for connecting to the computer for serial control.
3	Remote / Local LED	Lights Green to indicate which side of the installation (Local or Remote) currently has KVM control of the computer.
4	LAN LED	Lights to indicate the network status: <ul style="list-style-type: none"> ◆ Lights green when connected to the LAN. ◆ Off when not connected to the LAN. ◆ Blinks green when the Ethernet connection is active.
5	Power LED	Lights blue to indicate the unit is turned on.
6	Audio Ports	These mini stereo ports are for the speakers (green) and microphone (pink).

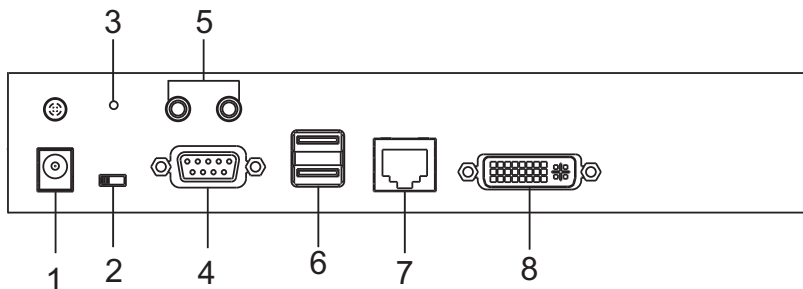
KE6900T (Transmitter) Rear View

No.	Component	Description
1	Power Jack	The cable from the DC Power adapter connects here.
2	Function Switch	Use this slide switch to set the unit's mode to: <ul style="list-style-type: none"> ◆ Configure: The device is ready to configure. ◆ Local: Only the local Transmitter has KVM control of the computer. The Receiver's KVM access to the computer is locked. ◆ Auto: Shared (simultaneous) KVM control of the computer at the Transmitter and Receiver console.
3	Reset	This switch must be pushed with a thin object, such as the end of a paper clip. <ul style="list-style-type: none"> ◆ Press and release to reboot the device. ◆ Power off, hold reset then power on the device while pressing reset to recover from a firmware upgrade failure. ◆ Press and hold it in for more than three seconds resets the unit back to its factory default settings.
4	RS-232 Port	This RS-232 serial port is for connecting to a serial terminal.
5	Audio Ports	These mini stereo ports are for the speakers (green) and microphone (pink).
6	Console Ports	The unit's USB keyboard and USB mouse plug into these ports.
7	LAN Port	The cable that connects the unit to the LAN plugs in here.
8	DVI-I Output	The cable from the local DVI monitor plugs in here.

KE6900R (Receiver) Front View

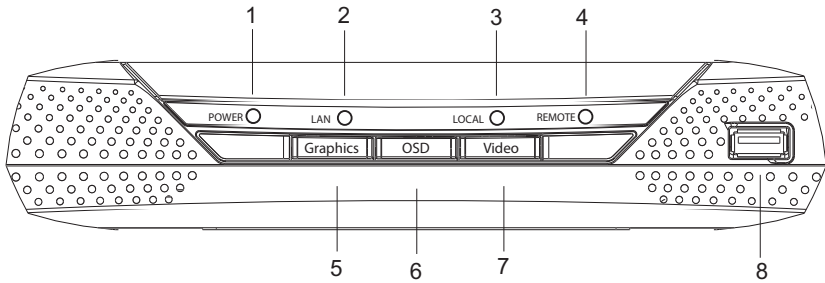

No.	Component	Description
1	Power LED	Lights blue to indicate the unit is turned on.
2	LAN LED	Lights to indicate the network status: <ul style="list-style-type: none"> ◆ Lights green when connected to the LAN. ◆ Off when not connected to the LAN. ◆ Blinks green when the Ethernet connection is active.
3	Local LED	Lights green to Indicate the Transmitter has KVM access of the computer.
4	Remote LED	Lights green to Indicate the Receiver has KVM access of the computer.
5	Graphics Pushbutton	Sets the displays image quality to the highest possible grade so that images are optimized. This toggle button turns off the Video Pushbutton option. Graphics mode is selected by default.
6	OSD Pushbutton	Use this pushbutton to open the OSD menu.
7	Video Pushbutton	Sets the displays image quality to a grade that is optimized for video playback. This toggle button turns off the Graphics Pushbutton option.
8	USB Port	Use this port for virtual media or a USB peripheral device. Note: When using a USB disk plugged into this port, see <i>USB Mode</i> , page 74.

KE6900R (Receiver) Rear View

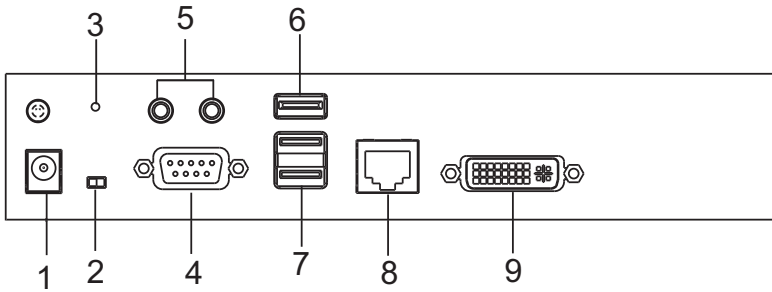

No.	Component	Description
1	Power Jack	The cable from the DC Power adapter connects here.
2	Function Switch	Use this slide switch to set the unit's mode: <ul style="list-style-type: none"> ◆ Extension: Sets the device to use the normal TX to RX extension mode. ◆ RS-232 Config: Sets the device so that you can configure it using a serial connection via the RS-232 port.
3	Reset	This switch must be pushed with a thin object, such as the end of a paper clip. <ul style="list-style-type: none"> ◆ Press and release to reboot the device. ◆ Power off, hold reset then power on the device while pressing reset to recover from a firmware upgrade failure. ◆ Press and hold it in for more than three seconds resets the unit back to its factory default settings.
4	RS-232 Port	This RS-232 serial port is for connecting to a serial terminal.
5	Audio Ports	These mini stereo ports are for the local speakers (green) and microphone (pink).
6	USB Port	Use this port for virtual media or a USB peripheral device. <p>Note: When using a USB disk plugged into this port, see <i>USB Mode</i>, page 74.</p>
7	Console Ports	The unit's USB keyboard and USB mouse plug into these ports. When using a keyboard or mouse with special functions, see <i>USB Mode</i> , page 74
8	LAN Port	The cable that connects the unit to the LAN plugs in here.
9	DVI-I Output	The cable from the local DVI monitor plugs in here.

KE6940T (Transmitter) Front View

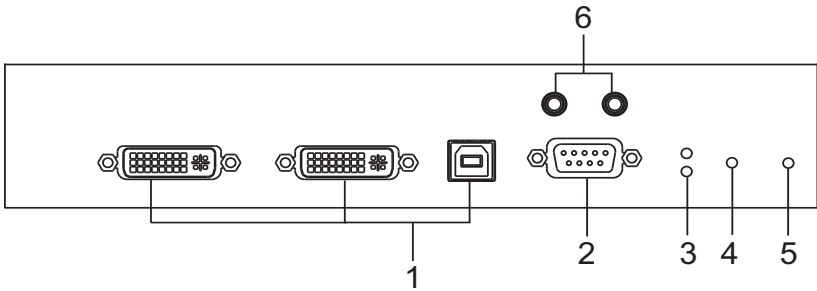

No.	Component	Description
1	KVM Ports	The USB KVM cable supplied with the package that links the Transmitter to the computer plugs into these ports.
2	RS-232 Port	This RS-232 serial port is for connecting to the computer for serial control.
3	Remote / Local LED	Lights green to indicate which side of the installation (Local or Remote) has KVM control of the computer.
4	LAN LED	Lights to indicate the network status: <ul style="list-style-type: none"> ◆ Lights green when connected to the LAN. ◆ Off when not connected to the LAN. ◆ Blinks green when the Ethernet connection is active.
5	Power LED	Lights blue to indicate the unit is turned on.
6	Audio Ports	These mini stereo ports are for the speakers (green) and microphone (pink).

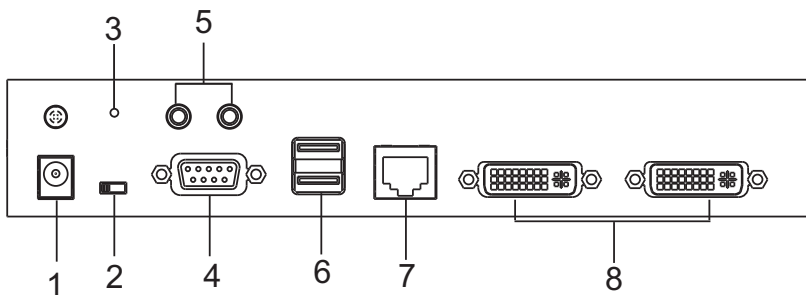
KE6940T (Transmitter) Rear View

No.	Component	Description
1	Power Jack	The cable from the DC Power adapter connects here.
2	Function Switch	Use this slide switch to set the unit's mode to: <ul style="list-style-type: none"> ◆ Configure: The device is ready to configure. ◆ Local: Only the local Transmitter has KVM control of the computer. The Receiver's KVM access to the computer is locked. ◆ Auto: Shared (simultaneous) KVM control of the computer at the Transmitter and Receiver console.
3	Reset	This switch must be pushed with a thin object, such as the end of a paper clip. <ul style="list-style-type: none"> ◆ Press and release to reboot the device. ◆ Power off, hold reset then power on the device while pressing reset to recover from a firmware upgrade failure. ◆ Press and hold it in for more than three seconds resets the unit back to its factory default settings.
4	RS-232 Port	This RS-232 serial port is for connecting to a serial terminal.
5	Audio Ports	These mini stereo ports are for the local speakers (green) and microphone (pink).
6	Console Ports	The unit's USB keyboard and USB mouse plug into these ports.
7	LAN Port	The cable that connects the unit to the LAN plugs in here.
8	DVI-I Output	The cable from the local DVI monitor plugs in here.

KE6940R (Receiver) Front View

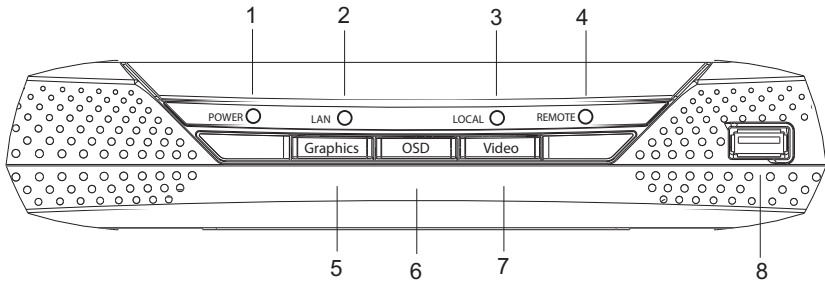

No.	Component	Description
1	Power LED	Lights blue to indicate the unit is turned on.
2	LAN LED	Lights to indicate the network status: <ul style="list-style-type: none"> ◆ Lights green when connected to the LAN. ◆ Off when not connected to the LAN. ◆ Blinks green when the Ethernet connection is active.
3	Local LED	Lights green to Indicate the Transmitter has KVM access of the computer.
4	Remote LED	Lights green to Indicate the Receiver has KVM access of the computer.
5	Graphics Pushbutton	Sets the displays image quality to the highest possible grade so that images are optimized. This toggle button turns off the Video Pushbutton option. Graphics mode is selected by default.
6	OSD Pushbutton	Use this pushbutton to open the OSD menu.
7	Video Pushbutton	Sets the displays image quality to a grade that is optimized for video playback. This toggle button turns off the Graphics Pushbutton option.
8	USB port	Use this port for virtual media or a USB peripheral device. Note: When using a USB disk plugged into this port, see <i>USB Mode</i> , page 74.

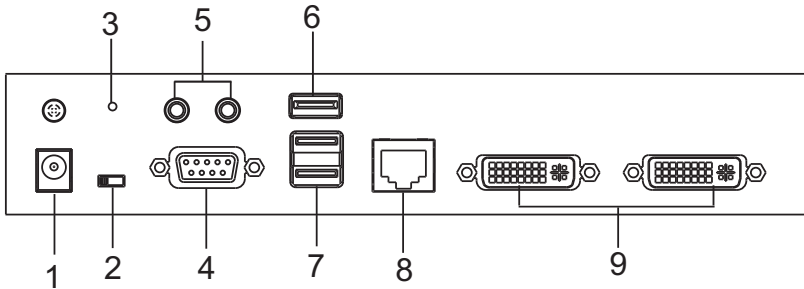
KE6940R (Receiver) Rear View

No.	Component	Description
1	Power Jack	The cable from the DC Power adapter connects here.
2	Function Switch	Use this slide switch to set the unit's mode: <ul style="list-style-type: none"> ◆ Extension: Sets the device to use the normal TX to RX extension mode. ◆ RS-232 Config: Sets the device so that you can configure it using a serial connection via the RS-232 port.
3	Reset	This switch must be pushed with a thin object, such as the end of a paper clip. <ul style="list-style-type: none"> ◆ Press and release to reboot the device. ◆ Power off, hold reset then power on the device while pressing reset to recover from a firmware upgrade failure. ◆ Press and hold it in for more than three seconds resets the unit back to its factory default settings.
4	RS-232 Port	This RS-232 serial port is for connecting to a serial terminal.
5	Audio Ports	These mini stereo ports are for the local speakers (green) and microphone (pink).
6	USB Port	Use this port for virtual media or a USB peripheral device. Note: When using a USB disk plugged into this port, see <i>USB Mode</i> , page 74.
7	Console Ports	The unit's USB keyboard and USB mouse plug into these ports.
8	LAN Port	The cable that connects the unit to the LAN plugs in here.
9	DVI-I Output	The cable from the local DVI monitors plug in here.

Chapter 2

Hardware Setup



1. Important safety information regarding the placement of this device is found on page 183. Please review it before proceeding.
2. Make sure that the power to all devices connected to the installation is turned off. You must unplug the power cords of any computers that have the Keyboard Power On function.

Rack Mounting

For convenience and flexibility, the Transmitter can be mounted on system racks. To rack mount a unit do the following:

1. Using the screws provided in the Mounting Kit, screw the mounting bracket into the bottom of the Transmitter as show below:

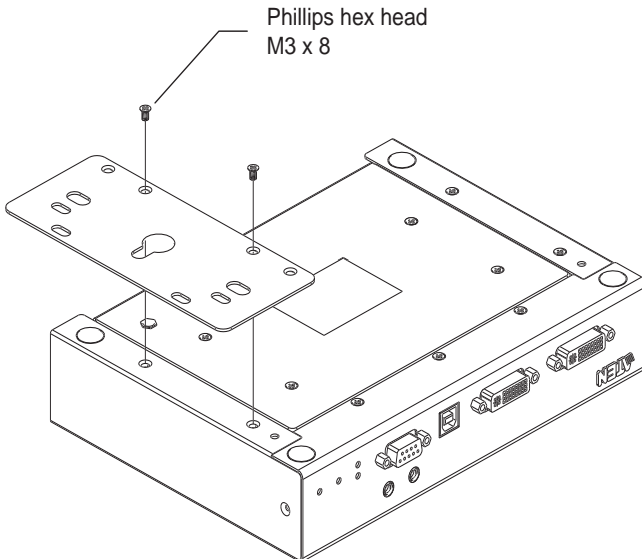

2. Screw the bracket into a convenient location on the rack.

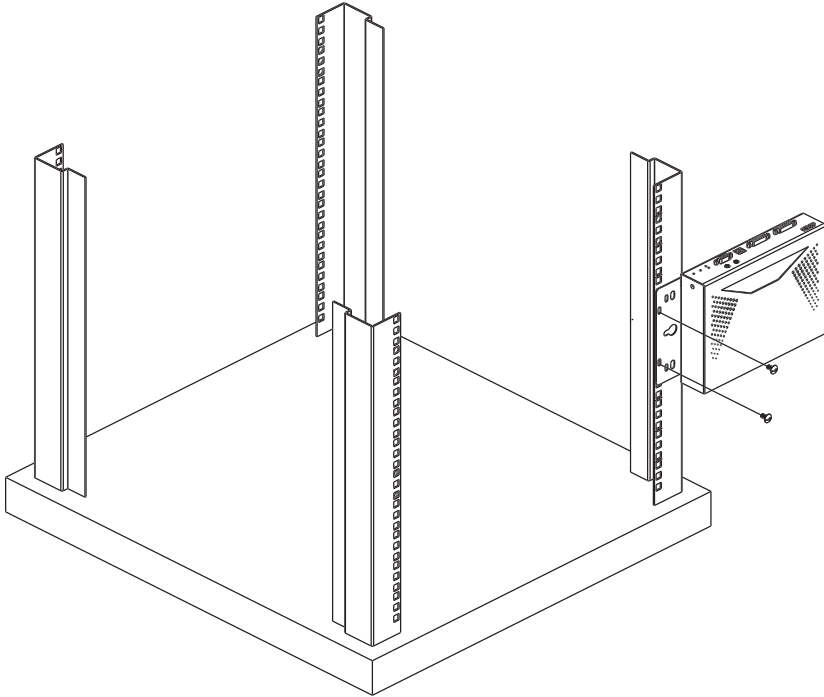

Note: These screws are not provided. We recommend that you use M5 x 12 Phillips Type I cross recessed type screws.

Wall Mounting

For convenience the Transmitter can be mounted to a wall.

1. Using the screws provided in the Mounting Kit, screw the mounting bracket into the bottom of the Transmitter as show below:

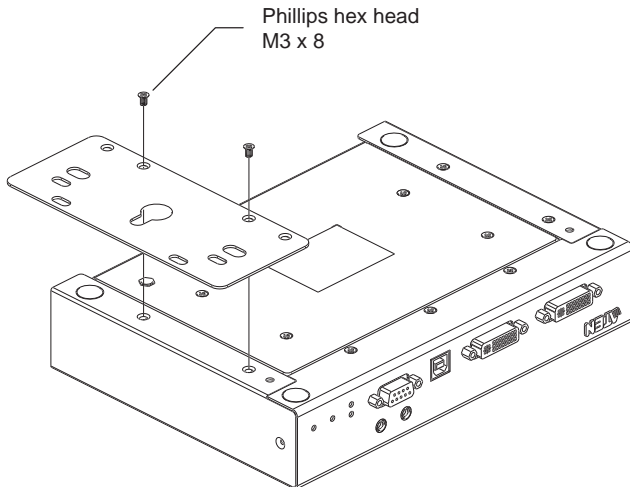

2. Use the center hole to screw the bracket to a secure wall surface.

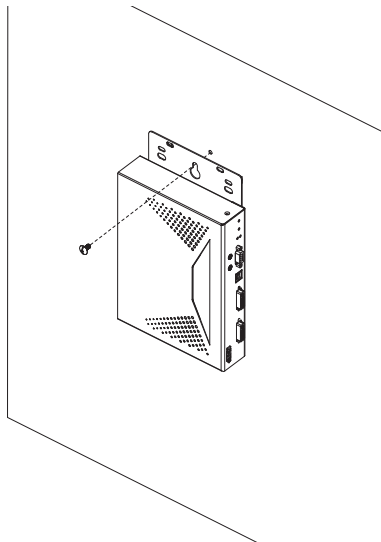

Setting Up a Point-to-Point Installation

Setting up the KE6900 / KE6940 system in a point-to-point configuration is simply a matter of plugging in the cables.

Note: In a point-to-point configuration, no administrator setup is necessary.

Make sure that all the equipment is powered off. Refer to the installation diagrams on the next two pages and do the following:

1. On the Transmitter side, plug the mouse, keyboard, DVI monitor, microphone and speakers into the ports on the Console section of the KE6900T / KE6940T*. Each port is marked with an appropriate icon to indicate itself.
2. Connect the USB KVM cable provided to the KVM Ports on the front of the KE6900T / KE6940T.
3. Connect the other end of the USB KVM cable to the keyboard, video, mouse, speaker and microphone ports on the computer.
4. For control of serial devices, connect the RS-232 serial port on the Transmitter to a serial port on the computer.
5. Connect a Cat 5e/6 cable to the KE6900T / KE6940T's LAN port.
6. Plug the power adapter into an AC source; and plug the other end into the KE6900T / KE6940T's Power Jack.
7. On the Receiver side, plug the mouse, keyboard, DVI monitor, microphone, and speakers into the ports on the Console section of the KE6900R / KE6940R*.
8. Connect the other end of the Cat 5e/6 cable to the KE6900R / KE6940R's LAN port.
9. Plug the second power adapter into an AC source; and plug the other end into the KE6900R / KE6940R's Power Jack.
10. Power on the computer.

Note: 1. If installing the KE6940 with two DVI monitors, connect the second DVI monitor via a DVI cable into the additional ports on the KE6940 and computer.

2. A keyboard or mouse with special functions may need to use the USB ports for advanced features to work (see *USB Mode*, page 74).
-

Point-to-Point Installation 1 of 2

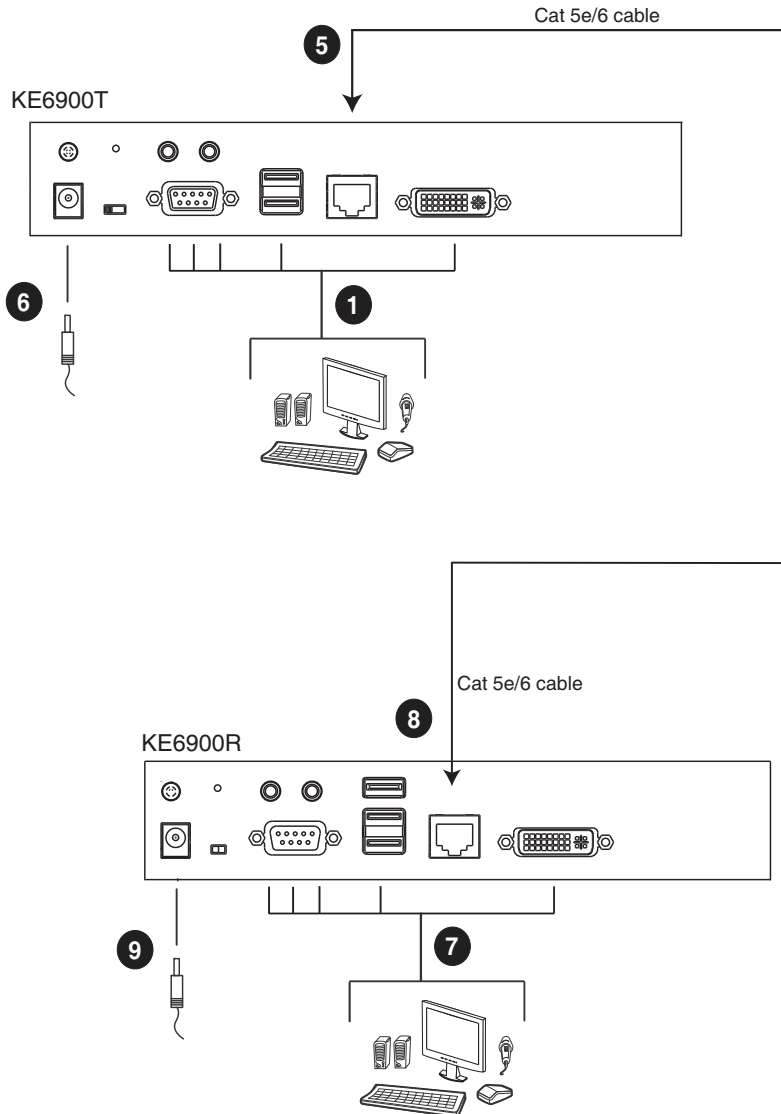

Note: The diagram above shows the KE6900T and KE6900R. The KE6940 installation is the same except that an additional DVI monitor can be connected at each end for a dual-view display setup.

Point-to-Point Installation 2 of 2

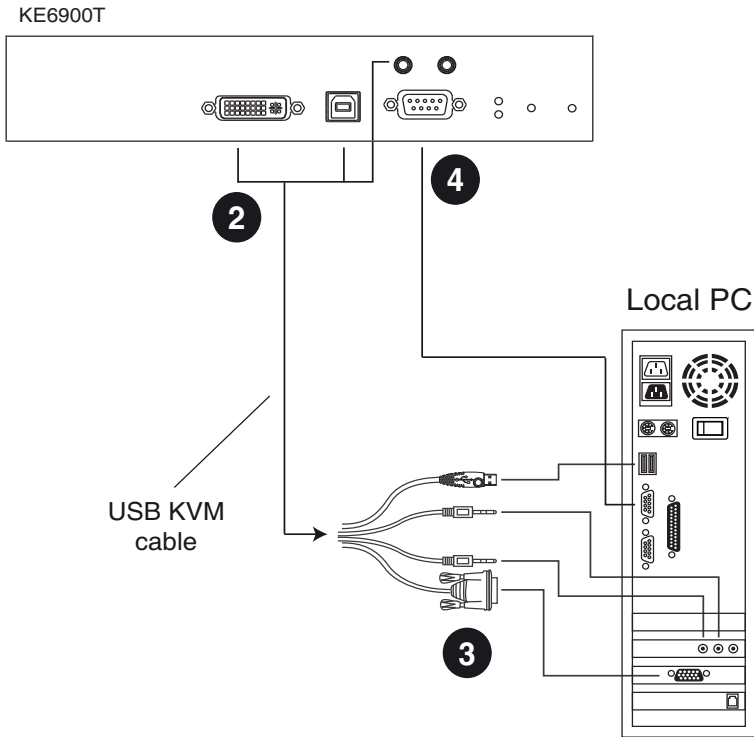

Note: The serial port on the Transmitter (shown above) connects to the computer; the serial port on the Receiver (not shown) connects to a serial device (optional).

Setting Up a LAN Installation

Setting up the units on a network allows point-to-point, point-to-multipoint, and multipoint-to-multipoint computer to console operation by connecting multiple KE6900 / KE6940 devices on the same TCP/IP LAN. Prior to setup we recommended laying out the plans for your KE installation using our performance guide, see *Keys to Network Performance*, page 200.

-
- Note:**
1. The units are preconfigured with factory-default network settings. If you install only one set of KE6900 / KE6940 units, you do not need to change these default network settings. See *Default IP Addresses*, page 24, for further details.
 2. In a network setup with multiple units, each Transmitter and Receiver must be configured with a unique IP address. See *Network Configuration*, page 23, for further details.
 3. We recommended using 1000Mbps Gigabit Ethernet switches (wire speeds, non-blocking with 1Gbps/1.5Mpps performance per port) between KE69xx devices installed on different LAN segments. 10/100Mbps switches might cause poor performance.
 4. In multipoint configurations, the IGMP and flow control function of your network switches/hubs must be enabled to avoid the deterioration of data throughput. To ensure functionality use a layer 3 switch that supports IGMP queries.
 5. If your network uses cascaded switches, please check to ensure the data throughput is sufficient.
 6. To get the best performance, we suggest creating a private network for KE69xx devices, as they are bandwidth-intensive devices.
-

Make sure that all the equipment is powered off. Refer to the installation diagram on the following page, and do the following:

1. On the Transmitter side, plug the mouse, keyboard, DVI monitor, microphone and speakers into the ports on the Console section of the KE6900T / KE6940T*. Each port is marked with an appropriate icon to indicate itself.
2. Connect the USB KVM cable provided to the KVM Ports on the front of the KE6900T / KE6940T.
3. Connect the other end of the USB KVM cable to the keyboard, video, mouse, speaker and microphone ports on the computer.

4. For control of serial devices, connect the RS-232 serial port on the Transmitter to a serial port on the computer.
5. Use a Cat 5e/6 cable to connect the KE6900T / KE6940T's LAN port to the local area TCP/IP network.
6. Plug the power adapter into an AC source; and plug the other end into the KE6900T / KE6940T's Power Jack.
7. On the Receiver side, plug the mouse, keyboard, DVI monitor, microphone, and speakers into the ports on the Console section of the KE6900R / KE6940R*.
8. Use a Cat 5e/6 cable to connect the KE6900R / KE6940R's LAN port to the local area TCP/IP network.
9. Plug the second power adapter into an AC source; and plug the other end into the KE6900R / KE6940R's Power Jack.
10. Use the OSD on the Receiver to configure the network settings for both devices (See *Network Configuration*, page 23).
11. Repeat these steps for each Transmitter and Receiver you wish to install on the network.
12. Power on the computer(s).

Note: 1. If installing the KE6940 with two DVI monitors, connect the second DVI monitor via a DVI cable into the additional ports on the KE6940 and computer.

2. A keyboard or mouse with special functions may need to use the USB ports for advanced features to work (see *USB Mode*, page 74).

Network Installation Diagram 1 of 2

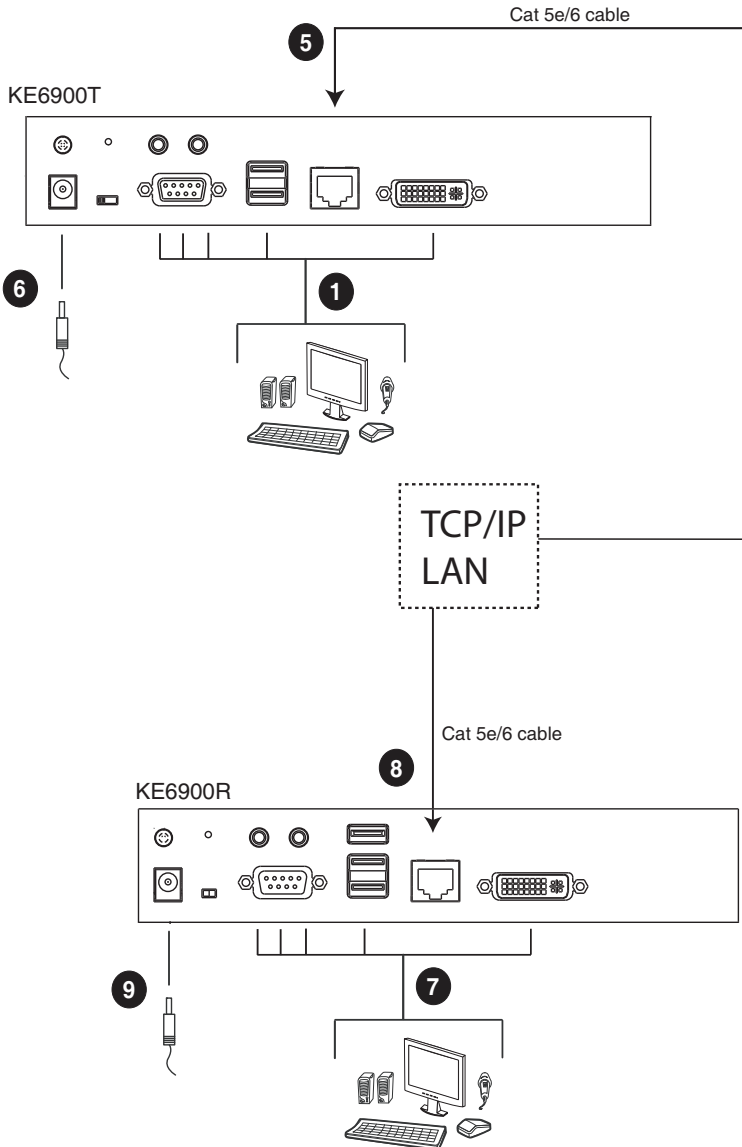

Note: The diagram above shows the KE6900T and KE6900R. The KE6940 installation is the same except that an additional DVI monitor can be connected at each end for a dual-view display setup.

Network Installation Diagram 2 of 2

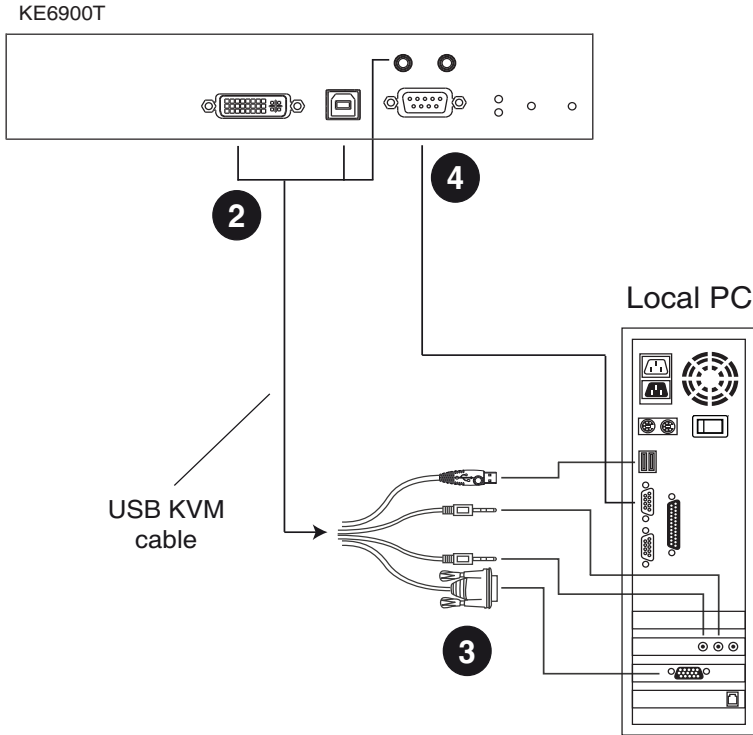

Note: The serial port on the Transmitter (shown above) connects to the computer; the serial port on the Receiver (not shown) connects to a serial device (optional).

Network Configuration

This section provides instructions to configure the network settings with a fixed IP address, subnet mask, and default gateway. To use the **IP Installer** to configure the IP address, see *IP Installer*, page 194.

-
- Note:**
1. Both devices are preconfigured with factory-default network settings. If you install only one set of KE6900 / KE6940 units, you do not need to change these default network settings. See *Default IP Addresses*, page 24, for further details.
 2. In a network setup with multiple units, each KE6900T / KE6940T and KE6900R / KE6940R must be configured with a unique IP address. See *Network Configuration*, page 23, for further details.
 3. We recommended using 1000Mbps Gigabit Ethernet switches (wire speeds, non-blocking with 1Gbps/1.5Mpps performance per port) between KE69xx devices installed on different LAN segments. 10/100Mbps switches might cause poor performance.
 4. In multipoint configurations, the IGMP and flow control function of your network switches/hubs must be enabled to avoid the deterioration of data throughput. To ensure functionality use a layer 3 switch that supports IGMP queries.
 5. If your network uses cascaded switches, please check to ensure the data throughput is sufficient.
 6. To get the best performance, we suggest creating a private network for KE69xx devices, as they are bandwidth-intensive devices.
-

To configure the network settings, do the following:

1. Setup the hardware and connect the Transmitter and Receiver to the local area network (See *Setting Up a LAN Installation*, page 19, for details).
2. From the Receiver, tap the **Scroll Lock** key twice to invoke the OSD.
3. Select the *User Station* or *Transmitter* from the sidebar menu.
4. Enter the password and click **Configure**.
The default password is: `password`.
5. From the *Network* tab select **Set IP address manually** and enter the following:
 - ◆ *IP Address*– sets the IP address for the KE6900 / KE6940. Key in a valid unique IP address.

Note: See *Default IP Addresses*, page 24, for the preconfigured factory-default settings.

- ◆ *Subnet Mask* – sets the subnet mask for the KE6900 / KE6940. Key in a valid subnet mask value.

Note: The default setting is 255 . 255 . 255 . 0

- ◆ *Default Gateway*– sets the default gateway for the KE6900 / KE6940. Key in a valid default gateway.

6. Click **Save**.

Exit OSD

To exit the OSD, press [**Esc**] on the keyboard, click **Logout**; tap the **Scroll Lock** key twice; or return to the OSD main page and press the front panel OSD pushbutton (Receiver only).

At this point the Receiver can connect to the Transmitter to access the remote computer (see *Connecting*, page 40 for instructions).

Default IP Addresses

The preconfigured factory-default IP addresses for the KE6900 / KE6940 units are as follows:

KE6900T / KE6940T – 192 . 168 . 0 . 61

KE6900R / KE6940R – 192 . 168 . 0 . 60

KE6900 I/O Ports

The following table provides the I/O port use of KE6900 devices.

Device	Port	Number
KE Manager (TCP)	HTTP	8080
	HTTPS	8443
	Device TCP	9110
	CLI	9111
	Redundancy	9120
	Database Service	1527
KE Manager (UDP)	Port	9110
	Broadcast	9000
KE TX/RX Device (TCP)	Manager	9110
	Service	9000
	Telnet	23
	SSH	22
KE TX Device (TCP)	VM	9001
	vUSB	9002
	Serial	9003
	USB Access Mode	9009
KE RX Device (TCP)	CLI	9130
KE TX/RX Device (UDP)	Manager	9110
	Service	9000
	Array Mode	9120
	Video	0xFE00(65024) - 0xFE03(65027)
	Audio	0xFE04(65028) - 0xFE05(65029)

This Page Intentionally Left Blank

Chapter 3

OSD Operation

Overview

This chapter provides instructions to configure and operate the KE6900 / KE6940 using the local On Screen Display (OSD). To configure the network settings with the OSD, see *Network Configuration*, page 23.

LED Display

Both the Transmitter and Receiver have front panel LEDs to indicate their operating and power status, as explained in the table below:

LED	Indication
LAN	<ul style="list-style-type: none">◆ Lights green when connected to the LAN.◆ Off when not connected to the LAN.◆ Blinks green when the Ethernet connection is active.
Power	<ul style="list-style-type: none">◆ Lights blue when the unit is powered on.◆ OFF when power is off.
Local	<ul style="list-style-type: none">◆ Lights green to Indicate the Transmitter has KVM focus of the computer
Remote	<ul style="list-style-type: none">◆ Lights green to Indicate the Receiver has KVM focus of the computer.

Invoking the OSD

The On Screen Display (OSD) is a keyboard/mouse-driven application on the receiver used to configure the transmitter and receiver settings. Once the receiver has discovered the transmitter over a network* or direct Ethernet cable connection, you can use the OSD on the receiver to configure the transmitter's settings.

To invoke the OSD, press the OSD pushbutton on the front of the receiver, or from the keyboard tap the **Scroll Lock** key twice. The *OSD* main page will appear (see *OSD Interface*, page 29).

To exit the OSD, press **[Esc]** on the keyboard; click **Logout**; tap the **Scroll Lock** key twice; or return to the OSD main page and press the OSD pushbutton on the front of the receiver. The OSD disappears and the computer desktop screen or the System Login prompt is displayed.

-
- Note:**
1. For the Receiver to discover the Transmitter over a network, both must be on the same subnet of the LAN.
 2. To change the OSD hotkeys see page 39.
 3. If the keyboard/mouse won't work when the OSD is invoked, see *USB Mode*, page 74.
-

Microphone Hotkey

You can switch microphone access between User Stations with a hotkey:

1. Press and hold down **[Num Lock]**.
2. Press and release **[-]**.
3. Release **[Num Lock]**.
4. Press **1**.

Press the **Esc** key to cancel.

Touch Screen Calibration

If you're using a touch screen monitor and the OSD appears off center, you can use the blinking **+** at each corner to adjust the position of the OSD.

OSD Interface

After you invoke the OSD, the main page appears:



Note: A password is required to enter the OSD. The default password is: *password*. For security purposes, we recommend you change this to something unique.

The OSD components are described in the table, below:

No.	Item	Description
1	User Station (Receiver)	Select this radio button, enter a password, and click Configure to enter the <i>User Station Configuration</i> screen.
2	Transmitter	Select this radio button, enter a password, and click Configure to enter the <i>Transmitter Configuration</i> screen. Note: Receiver must first discover the transmitter over the network for this option to be available.
3	User Preferences	Select this radio button, enter a password, and click Configure to enter the <i>User Preferences</i> screen.
4	About	About provides information regarding the OSD version.
5	Password	Input the OSD password and click Configure to enter the selected configuration screen. See note for password.
6	Configure	After entering a password, click Configure to enter the selected configuration screen.
7	Back to Video	Clicking this button exits the OSD and returns you to the computer's video display.

User Station Configuration

When you select the *User Station* radio button and click **Configure** to login, the Network tab appears:

The screenshot shows the Altusen KE OSD interface. On the left, a blue sidebar contains navigation options: 'User Station' (selected), 'Transmitter', 'User Preferences', and 'About'. Below these is a 'Password' field and a 'Configure' button. At the bottom of the sidebar is a 'Back to Video' button. The main area has three tabs: 'Network', 'Properties', and 'System'. The 'Network' tab is active, displaying the 'IP Installer' section with three radio buttons: 'Enable' (selected), 'View Only', and 'Disabled'. Below this is the 'IP Properties' section, which has two radio buttons: 'Obtain IP address automatically' and 'Set IP address manually' (selected). Under 'Set IP address manually', there are three input fields: 'IP Address' (192.168.0.60), 'Subnet Mask' (255.255.255.0), and 'Default Gateway'. A 'Save' button is located at the bottom right of the main area.

Network

The Network tab allows you to configure the User Station's IP address settings:

Item	Description
IP Installer	The IP Installer is an external Windows-based utility for assigning an IP address to the device. Click one of the radio buttons to select Enable , View Only , or Disable for the IP Installer utility. See <i>IP Installer</i> , page 194 for instructions. Note: For security, we strongly recommend that you set this to <i>View Only</i> or <i>Disable</i> after each use.
Network Configuration	For dynamic IP address assignment (DHCP), select the Obtain IP address automatically radio button. To specify a fixed <i>IP Address</i> , <i>Subnet Mask</i> , and <i>Default Gateway</i> select the Set IP address manually radio button and fill in the fields with values appropriate for your network. For help configuring network settings with the OSD, See <i>Network Configuration</i> , page 23.

After entering the information, click **Save**.

Properties

The *Properties* tab allows you to configure the User Station's extender settings:

The screenshot shows the 'Properties' tab of a configuration window. It features several sections:

- Mode:** Two radio buttons, 'Extender' (selected) and 'Matrix'.
- RS232 Settings:** Five dropdown menus: Baud Rate (9600), Data Bits (8), Parity (None), Stop Bits (1), and Flow Control (None).
- Properties:** Four input fields for Transmitter Video IP, Transmitter Audio IP, Transmitter USB IP, and Transmitter RS232 IP, all set to 192.168.0.61. Below them are four checked checkboxes for 'Enable Media': Video, Audio, USB, and RS232.
- Manager Address:** Two input fields, 'KE Manager IP' and 'KE Manager Port' (9110).
- Beeper:** An unchecked checkbox labeled 'Enable'.
- USB Mode:** Three radio buttons: 'VM' (selected), 'vUSB', and 'Secure'.

 A blue 'Save' button is located at the bottom right of the form.

Item	Description
Mode	<p>Select Extender mode for simple one-to-one (Transmitter to User Station) setups that are managed with the Receiver's OSD menu.</p> <p>Select Matrix mode to manage devices and connections from the Matrix Manager web GUI. This mode is for advanced administration of Transmitter to User Station connections. (See <i>Channel Connections</i>, page 87)</p>
Properties	<p>If you selected Extender mode (above) set the Transmitter IP address for the User Station's Video, Audio, USB, and RS232 source signals.</p> <p>If you selected Matrix mode (above) the <i>Properties</i> will be grayed out. Use Channels to configure the Transmitter connections. (See <i>Channel Connections</i>, page 87)</p>

Item	Description
RS232 Settings	Configure the serial device settings for the User Station. The default settings are: Baud Rate: 9600 Parity: None Data Bits: 8 bits Stop bits: 1 bit Flow Control: None
Enable Media	Select which type of media the User Station can stream from Transmitters: Video, Audio, USB, and RS232.
Manager Address	Set the IP address and Port number of the computer running the Matrix Manager software. The default port number is 9110.
Beeper	Check this box to allow the User Station to beep when configuration changes are made to it.
USB Mode	Select the type of USB device you will connect to the USB ports: vUSB (generic USB device) : Use this option to plug USB peripherals into the USB ports. This option also allows a keyboard and mouse with special functions to plug into the USB ports for console use. Use this only if the special functions of the keyboard or mouse are required but do not work when plugged into the console ports. When the keyboard and mouse are plugged into the USB ports, they will not work within the OSD menus. To work within the OSD menus, the keyboard and mouse must be plugged into the console ports. VM (Virtual Media) : Only select this option if you are plugging a USB disk into the USB ports. This will give you the highest data transfer speeds but will not allow other USB devices plugged into the USB ports to work. Secure : Check this box to encrypt USB drives plugged into the USB ports.

After entering the information, click **Save**.

System

The *System* tab allows you to configure the User Station's general settings:

The screenshot shows the 'System' configuration page. At the top, there are three tabs: 'Network', 'Properties', and 'System', with 'System' being the active tab. Below the tabs is the 'Device Information' section, which contains several input fields and read-only information. The 'Name' field is filled with 'KE6940R'. Below it is a 'Description' field. Further down, 'IP Address' is '192.168.0.60' and 'MAC Address' is '00:10:74:a8:01:37'. The 'F/W Version' is 'V1.1.106 (May 2 2014 13:39:47)' and 'Serial Number' is also present. Below this is the 'Reboot' section, which includes a checkbox for 'Reset to factory default' and a 'Reboot' button. The 'User Station Password Change' section has a checked 'Enable' checkbox and three password input fields labeled 'Old Password', 'New Password', and 'Confirm Password'. A 'Save' button is located at the bottom right of the form.

Item	Description
Device Information	Enter the Name , Location , and Description of the User Station. It also displays the <i>IP Address</i> , <i>MAC Address</i> , <i>F/W Version</i> , <i>Serial Number</i> , and <i>Model Number</i> of the User Station.
Reboot	Check the box and click Reboot to reset the User Station's settings back to the factory default. All custom settings will be lost.
User Station Password Change	Check Enable to require a password for access to the User Station's OSD configuration screen. Enter the Old Password, enter a New Password, and confirm the new password in the Confirm Password box.

After entering the information, click **Save**.

Transmitter Configuration

When you select the *Transmitter* radio button and click **Configure** to login, the Network tab appears:

Network

The *Network* tab allows you to configure the Transmitter's IP address settings:

Item	Description
IP Installer	<p>The IP Installer is an external Windows-based utility for assigning an IP address to the device. Click one of the radio buttons to select Enable, View Only, or Disable for the IP Installer utility. See <i>IP Installer</i>, page 194 for instructions.</p> <p>Note: For security, we strongly recommend that you set this to <i>View Only</i> or <i>Disable</i> after each use.</p>
Network Configuration	<p>For dynamic IP address assignment (DHCP), select the Obtain IP address automatically radio button.</p> <p>To specify a fixed <i>IP Address</i>, <i>Subnet Mask</i>, and <i>Default Gateway</i> select the Set IP address manually radio button and fill in the fields with values appropriate for your network.</p> <p>For help configuring network settings with the OSD, See <i>Network Configuration</i>, page 23.</p>

After entering the information, click **Save**.

Properties

The *Properties* tab allows you to configure the Transmitter's extender settings:

Item	Description
Mode	<p>Select Extender mode for simple one-to-one (Transmitter to User Station) setups that are managed with the Receiver's OSD menu.</p> <p>Select Matrix mode to manage devices and connections from the Matrix Manager web GUI. This mode is for advanced administration of Transmitter to User Station connections. (See <i>Channel Connections</i>, page 87)</p>

Item	Description
Properties	<p>Port OS: Use the drop-down menu to select the operating system of the computer connected to the Transmitter.</p> <p>OS Language: Use the drop-down menu to select the operating system language of the computer connected to the Transmitter.</p> <p>Enable Multicast Video: Check this box to allow a broadcast of the Transmitter's video signal to be sent out to multiple User Stations.</p> <p>Enable Multicast Audio: Check this box to allow a broadcast of the Transmitter's audio signal to be sent out to multiple User Stations.</p> <p>EDID Mode Selection: EDID contains a display's basic information and is used by the source device to utilize the best resolution across different monitors. Select how you want the source device to acquire the display's EDID:</p> <ul style="list-style-type: none"> ◆ Default: EDID is set to the default ATEN configuration. ◆ Auto: Checks the EDID of all connected displays and uses the best resolution for all displays. ◆ Manual: Manually set the EDID configuration from the Connections Page (see page 41). ◆ Remix: Checks the EDID of all connected displays and the source device uses the best common resolution for all displays.
Enable Media	Select which type of media the Transmitter can stream to User Stations: Video, Audio, USB, and RS232.
RS232 Settings	<p>Configure the serial device settings for the Transmitter. The default settings are:</p> <p>Baud Rate: 9600</p> <p>Parity: None</p> <p>Data Bits: 8 bits</p> <p>Stop bits: 1 bit</p> <p>Flow Control: None</p>
Manager Address	Set the IP address and Port number of the computer running the Matrix Manager software. The default port number is 9110.

Item	Description
Transmitter Video Attributes	<p>To set the Transmitter's video settings:</p> <p>Video Type: Select the DVI video connector being used by the display: Digital (DVI-D) or Digital (DVI-I).</p> <p>Color Depth: Select the number of bits to use for the color depth: 24, 16, or 8. This is the number of bits used to describe the color of a single pixel. A bit depth determines the number of colors that can be displayed at one time.</p> <p>Bandwidth Limit: Select the maximum bandwidth that the Transmitter can use to transmit video over the network. A lower bandwidth setting transmits lower quality video; a higher bandwidth setting sends higher quality video but this can affect network speed.</p> <p>Video Quality: Select the video quality to use. 5 is the highest video quality, and 1 is the lowest video quality. Options are: 1-5.</p> <p>Background Refresh: Sets how often the Transmitter refreshes the background image on the connected display. Options are to refresh every 256,128, 64, 32,16, or 0 frames.</p>
Beeper	<p>Check this box to allow the device to beep every time a configuration change is made.</p>
Occupy Timeout	<p>Set a time threshold for devices whose Access Mode has been set to Occupy (see <i>Allowed Access Mode</i>, page 122). If there is no activity from the User Station occupying the port for the amount of time set here, the User Station is timed out and the port is released. The first User Station to send keyboard or mouse input after the port has been released gets to occupy the port. Input a value from 1 to 240 seconds.</p>

After entering the information, click **Save**.

System

The *System* tab allows you to configure the Transmitter's general settings:

The screenshot shows the 'System' configuration page. It includes three tabs: 'Network', 'Properties', and 'System'. The 'System' tab is selected. The page is divided into three main sections: 'Device Information', 'Reboot', and 'Transmitter Password Change'.
 - **Device Information:** A form with fields for Name (KE6940T), Description, IP Address (192.168.0.61), MAC Address (00:00:00:a9:01:37), F/W Version (V1.1.106 [May 2 2014 13:39:47]), and Serial Number.
 - **Reboot:** A checkbox labeled 'Reset to factory default' and a 'Reboot' button.
 - **Transmitter Password Change:** A checked checkbox labeled 'Enable' and three password input fields: 'Old Password', 'New Password', and 'Confirm Password'. A 'Save' button is located at the bottom right of the form.

Item	Description
Device Information	Enter the Name , Location , and Description of the Transmitter. It also displays the <i>IP Address</i> , <i>MAC Address</i> , <i>F/W Version</i> , <i>Serial Number</i> , and <i>Model Number</i> of the Transmitter.
Reboot	Check the box and click Reboot to reset the Transmitter's settings back to the factory default. All custom settings will be lost.
Transmitter Password Change	Check Enable to require a password for access to the Transmitter's OSD configuration screen. Enter the Old Password, enter a New Password, and confirm the new password in the Confirm Password box.

After entering the information, click **Save**.

User Preferences

When you select the *User Preferences* radio button and click **Configure** to login, the configuration screen appears:

The screenshot shows a web-based configuration interface. On the left, a blue sidebar contains navigation options: 'User Station', 'Transmitter', 'User Preferences' (selected), and 'About'. Below these is a 'Password' field with a 'Configure' button and a 'Back to Video' button. The main content area is titled 'User Password Change' and contains three input fields for 'Old Password', 'New Password', and 'Confirm Password'. Below this is the 'OSD Settings' section, which includes:

- 'OSD Language' with a dropdown menu currently showing 'English'.
- 'OSD Hotkey' with a dropdown menu showing '[scroll lock]'.
- 'Logout Timeout' with a numeric input field set to '0', a range indicator 'min (0-180)', and a checked 'Disabled' checkbox.
- 'Screen Blanker' with a numeric input field set to '0', a range indicator 'min (0-30)', and a checked 'Disabled' checkbox.

 A 'Save' button is located at the bottom right of the configuration area.

Item	Description
User Password Change	This section allows you to change the OSD password: <ol style="list-style-type: none"> 1. Key in the old password in the Old password field. 2. Key in the new password in the New password field. 3. Key in the new password again in the Confirm password field.
OSD Language	Click the drop-down menu to select the language you want to use for OSD sessions. Choices are: English, Chinese (Simplified), Chinese (Traditional), Japanese, Korean, Dutch, French, Spanish, Portuguese, and Russian.
OSD Hotkey	Select the hotkey combination to invoke the OSD screen.
Logout Timeout	If there is no user input for the amount of time set with this function, the user is automatically logged out of the OSD. A login is necessary before the OSD can be accessed again.
Screen Blanker	Set how many minutes the OSD waits when a session is idle before turning off the display.

When you have made your choices, Click **Save**.

Connecting

If the User Station is set to **Extender** mode, the video screen of the remote computer will appear automatically when you exit the OSD (press **Esc** to exit). In **Matrix** mode you will see the *System Login* screen, which provides access to the *Connection Page* by entering a username and password:

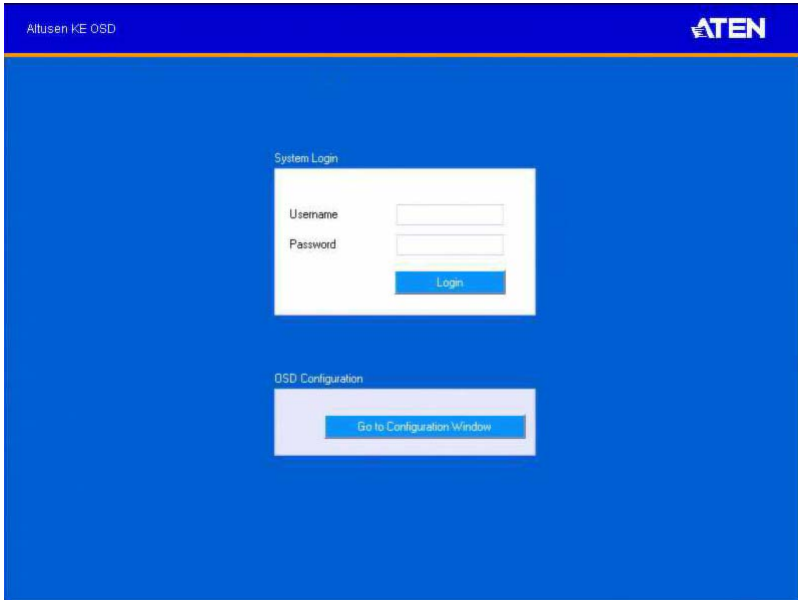

-
- Note:**
1. The administrator account can be used to log in for the first time. Username: *administrator* / Password: *password*. For security purposes, we recommend you change this to something unique (see *User Management*, page 105).
 2. If the User Station does not require a login, click *Login to system* (see *Login Required*, page 74).
 3. For information about Extender and Desktop/Matrix modes see *Mode*, page 31.
-

After you login the *Connection Page* appears, as shown on the next page.

Connections Page

After you have successfully logged in the *Connection Page* appears:

List Mode

Channel Name	Description	Connect				
♥ KE6940T 34	[VAUS]	Exclusive	Occupy	Share	View Only	Exit
♥ KE6940T-2	[VAUS]	Exclusive	Occupy	Share	View Only	Exit
KE6900T 33	[VAUS]	Exclusive	Occupy	Share	View Only	Exit
KE6940T 35	[VAUS]	Exclusive	Occupy	Share	View Only	Exit
KE6940T 36	[VAUS]	Exclusive	Occupy	Share	View Only	Exit
KE6900T-2	[VAUS]	Exclusive	Occupy	Share	View Only	Exit
KE6940T	[VAUS]	Exclusive	Occupy	Share	View Only	Exit
test08	[VAUS]null	Exclusive	Occupy	Share	View Only	Exit

The *Connection Page* components are described in the table, below:

No.	Item	Description
1	Channel Name	Lists the Channel connections available for the User Station. A Channel is a defined connection to Transmitters, created in the Device Management tab of the Matrix Manager (see <i>Channels</i> , page 88).
2	Description	This field provides a description of the Channel, entered when it was created.

No.	Item	Description
3	Connect	<p>To connect the User Station to a Channel, click the access type:</p> <p>Exclusive: The first User Station to access the Channel has exclusive control over the Channel. No other User Stations can view the Channel. The Timeout function does not apply to this setting.</p> <p>Occupy: The first User Station to access the Channel has control over the Channel. However, additional User Stations may view the Channel's video display. If the User Station controlling the Channel is inactive for longer than the time set in the Timeout box, control is transferred to the first User Station to move the mouse or strike the keyboard.</p> <p>Share: Can simultaneously share control over the Channel. Input from the User Stations is placed in a queue and executed chronologically.</p> <p>View Only: User Station connects with view only access to the Channels video display.</p>
4	Next Arrow	Use these two buttons to navigate to the next page or to the end of the list if there are more Channels available than can be seen on the page.
5	Previous Arrow	Use these two buttons to navigate to the previous page or to the beginning of the list if there are more Channels available than can be seen on the page.
6	Favorites / All	<p>Click Favorites to list only the Channels marked as favorites. Click All to list all Channels. Channels marked as favorites appear with a heart icon.</p> <p>To add/remove a Favorite, select a Channel and then right click with the mouse to select Add to Favorite or Remove from Favorite.</p>
7	Array Mode	Click to view the Channel connections with a video preview of each source. The list will be shown in groups of six at a time. A screens shot of the Array Mode is provided on the next page.
8	List Mode	Click to view the Channel connections in a list that can be sorted by name or with favorites listed first. Click the Channel Name heading to change the sort.
9	Manual EDID	If the EDID Model Selection on the Properties tab is set to Manual, the Manual EDID button appears here. Click Manual EDID to adjust the EDID setting locally. To set the EDID Mode to Manual, see <i>Properties</i> , page 36.
10	Logout	Click this button to log out of the Connection Page.
11	Go to Configuration Window	Click this button to return to the main OSD screen.

Array Mode

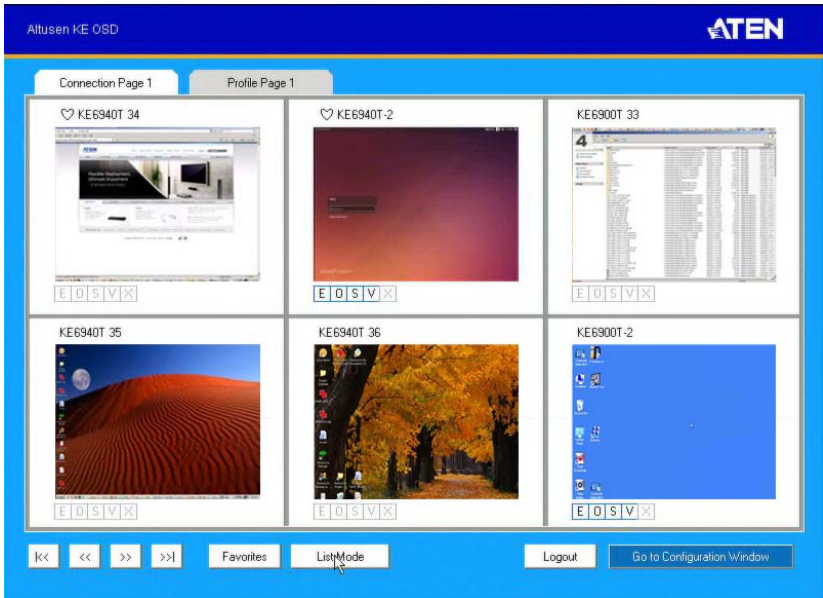

Profile / Video Wall Page

Click the *Profile / Video Wall Page* tab and the following screen appears:

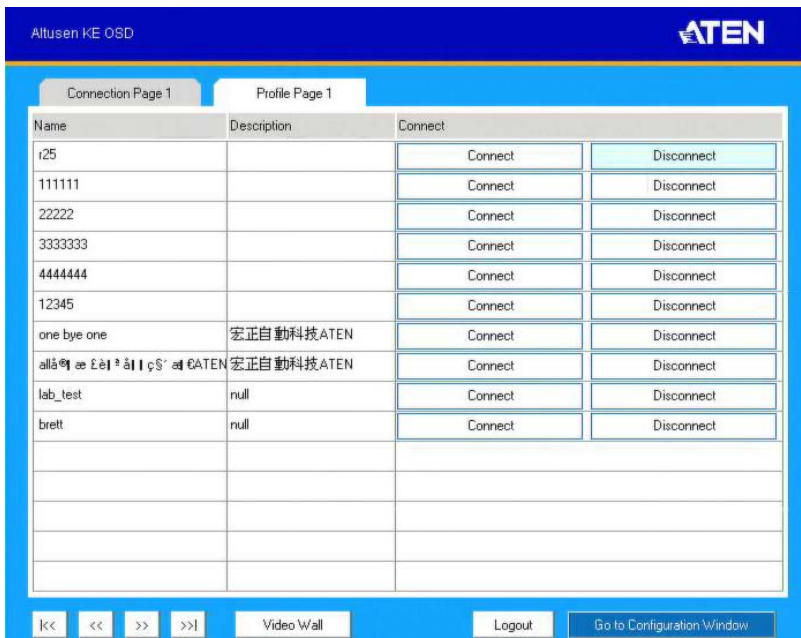

The *Profile / Video Wall Page* components are described in the table, below:

No.	Item	Description
1	Name	Lists the Profiles and Video Walls available. Profiles / Video Walls give User Stations access to Channels and allow you to push the connection.
2	Description	The field provides a description of the Profile/Video Wall that was entered when it was created.
3	Connect	Click Connect and the User Station will connect with the settings of that Profile or Video Wall (see <i>Profiles</i> , page 94 or <i>Video Wall</i> , page 98).
4	Disconnect	Click Disconnect to end the current Profile or Video Wall connection.
5	Next Arrow	Use these two buttons to navigate to the next page or to the end of the list if there are more Profiles/ Video Walls available than can be seen on the page.
6	Previous Arrow	Use these two buttons to navigate to the previous page or to the beginning of the list if there are more Profiles/Video Walls available than can be seen on the page.

No.	Item	Description
7	Video Wall	Click to view a list of available Video Wall connections. Appears when the Profile button has been clicked.
8	Profile	Click to view a list of available Profile connections. Appears when the Video Wall button has been clicked.
9	Logout	Click this button to log out of the Connection Page.
10	Go to Configuration Window	Click this button to return to the main OSD screen.

This Page Intentionally Left Blank

Chapter 4

Matrix Manager Software Installation

Overview

The *Matrix Manager* is a browser based GUI that provides management of KE6900 / KE6940 devices over a network. You can download the Matrix Manager Lite version which is free and manages up to 8 KE devices, or purchase a full version of the Matrix Manager software. To purchase the full version contact your local authorized ATEN dealer. To download the free Matrix Manager Lite software, use the instructions below.

Download - Trial Version

To download the Matrix Manager Lite software, do the following:

1. Visit our website and click **Support** → **Go to ATEN eService**.

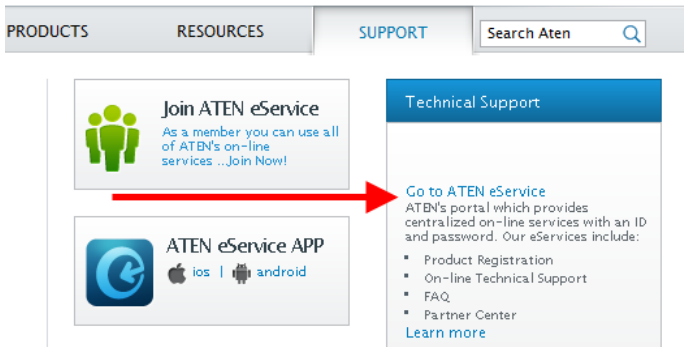

2. Create an account and Sign In to ATEN eService.

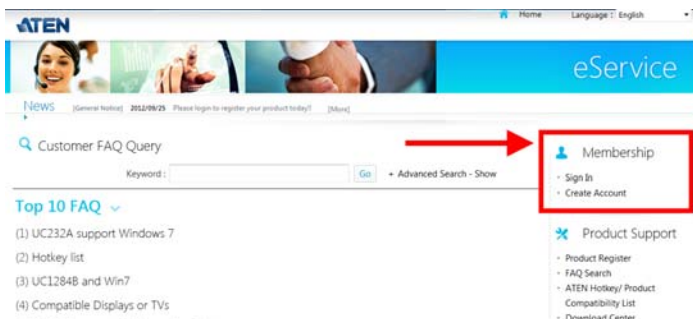

3. Register the KE690x device(s) you have purchased.



4. After you have registered the KE device(s), click **Trial Software Download**.

Product Register >

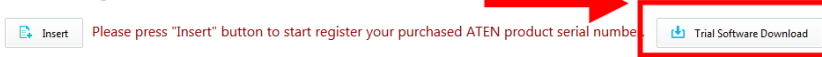

Serial Number	Model	Date of Purchase	Invoice / Shipping Document	Warranty Due Date	Action
12345678901235	KE6940	2015/10/20			

Note: The trial version or “*Matrix Manager Lite*” includes full functions to setup and configure up to 8 KE6900 (transmitter/receiver) devices. The *Matrix Manager Lite* version will never expire. If you would like to purchase the official full version of the Matrix Manager software, please contact your ATEN reseller and see page 52.

5. Click the software version you would like to download, then click **Save**.

My Download >

File Title	Web Site	File Download
Matrix Manager Lite V1.2.113.011 (Linux version)	KE6900 Matrix Manager Lite V1.2.113.011 link (click download icon to download KE Matrix Manager Lite (the Linux version))	↓
Matrix Manager Lite V1.2.113.011 (Windows version)	KE6900 Matrix Manager Lite V1.2.113.011 link (click download icon to download KE Matrix Manager Lite (the Windows version))	↓

6. Unzip the *Matrix_Manager_Lite.zip* file and double click the *.exe file to start the installation.

7. Follow the instructions on the next page to install the trial version of the software.

Matrix Manager Install

The following are instructions to install the full version of the Matrix Manager software. For software requirements, see *Software*, page 3.

1. Insert the USB license key into a USB port on your computer.
2. Double click the *MatrixManagerSetup* file to start the setup. When the *Introduction* screen appears, click **Next**.

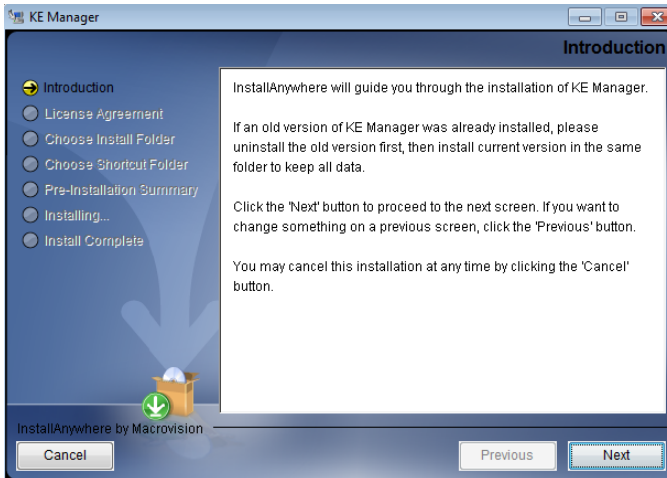

3. The *License Agreement* appears:

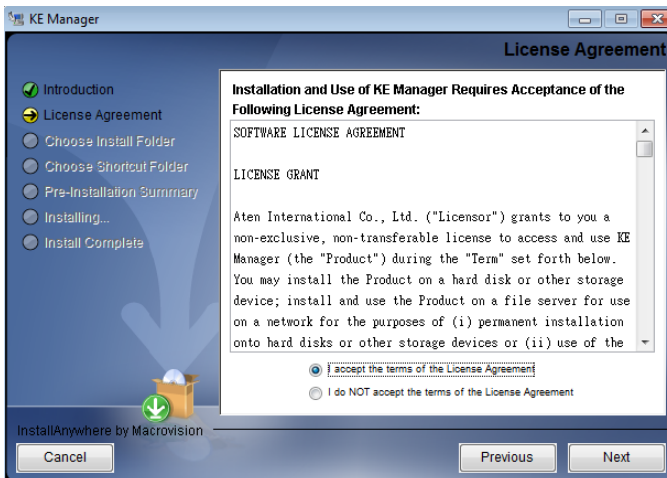

If you agree with the License Agreement, select *I accept the terms of the license agreement*, and click **Next**.

4. The *Choose Install Folder* screen appears:

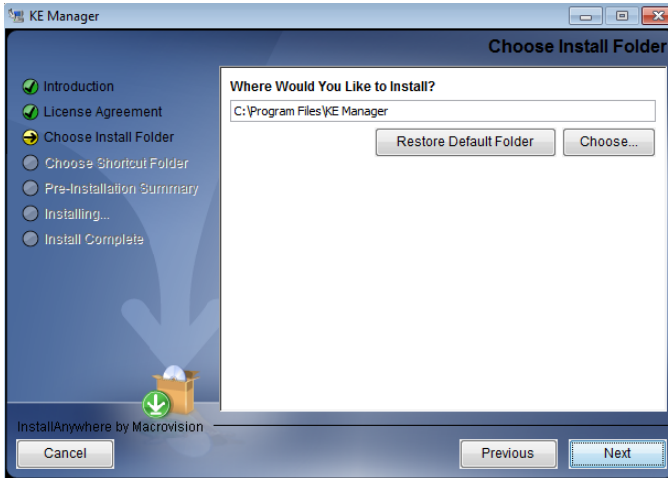

Select where you would like to install the program, and click **Next**.

5. The *Choose Shortcut Folder* screen appears:

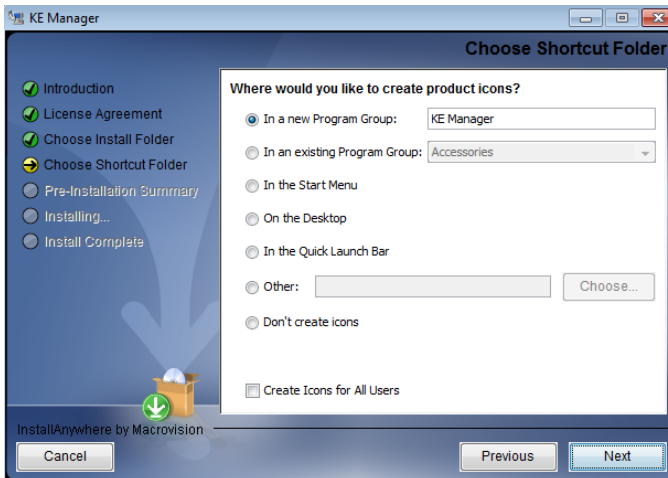

Select where to create shortcuts for the program by selecting the options provided, and click **Next**.

6. The *Pre-Installation Summary* screen appears:

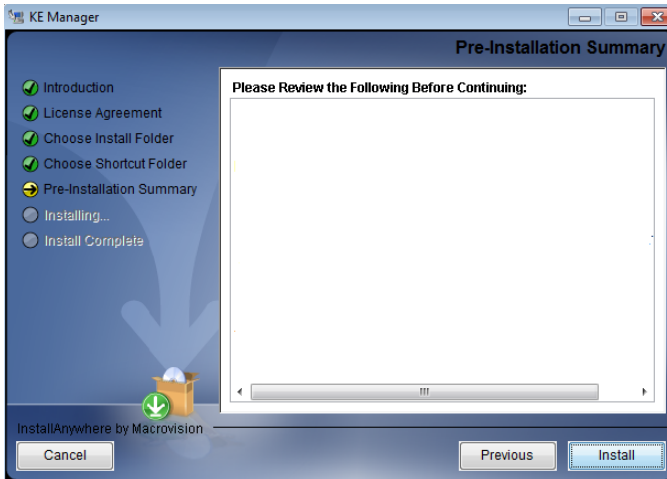

Confirm the settings you've selected. If you want to make a change click **Previous** to go back, or click **Install** to begin the software installation.

7. When the process is done, the *Install Complete* screen appears:

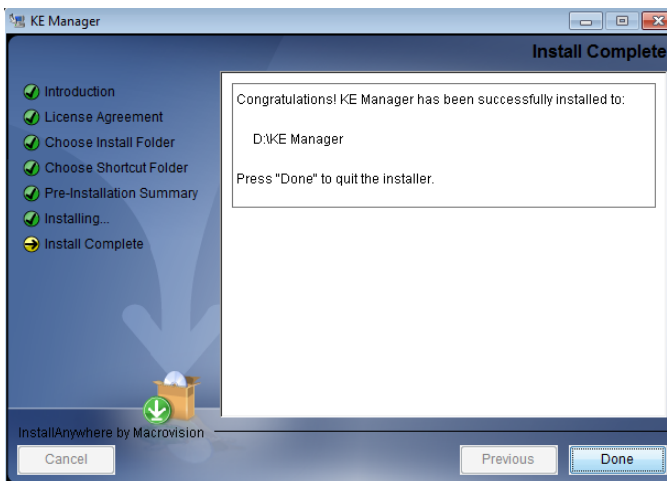

Click **Done**.

Note: If you are installing the Matrix Manager on a second computer for redundancy (see *Redundancy*, page 129) – remove the USB License key and plug it into the primary computer running the Matrix Manager software.

Upgrading Trial Version

After you purchase a license to upgrade the Matrix Manager Lite version to the full version of the Matrix Manager software, go to the System tab, and at the bottom of the Global Settings page, click **Upgrade**:

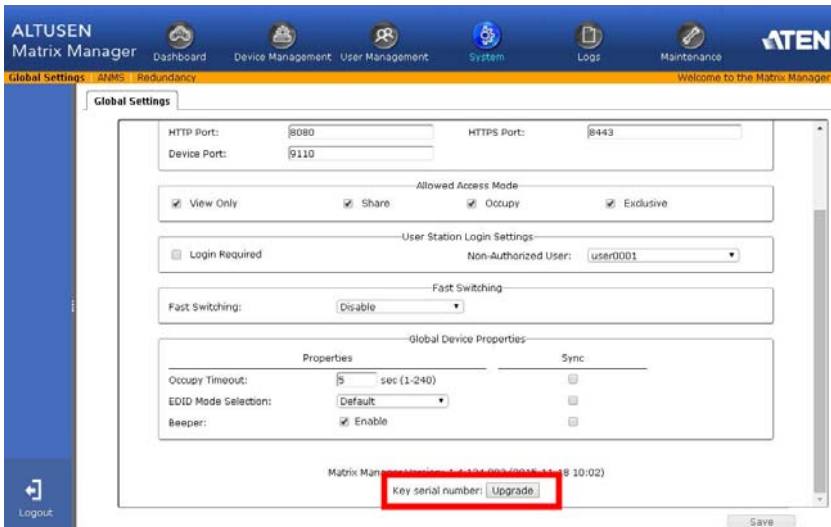

The screenshot displays the Matrix Manager web interface. The top navigation bar includes 'ALTUSEN Matrix Manager' and several menu items: Dashboard, Device Management, User Management, System, Logs, and Maintenance. The 'System' menu is selected. Below the navigation bar, the 'Global Settings' page is shown, with a breadcrumb trail: 'Global Settings > ANMS > Redundancy'. The page title is 'Welcome to the Matrix Manager'. The main content area is titled 'Global Settings' and contains several configuration sections:

- HTTP Port:** 8080
- Device Port:** 9110
- HTTPS Port:** 8443
- Allowed Access Mode:** View Only (checked), Share (checked), Occupy (checked), Exclusive (checked)
- User Station Login Settings:** Login Required (unchecked), Non-Authorized User: user0001
- Fast Switching:** Disable
- Global Device Properties:**

Properties	Sync
Occupy Timeout: 5 sec (1-240)	<input type="checkbox"/>
EDID Mode Selection: Default	<input type="checkbox"/>
Beeper: <input checked="" type="checkbox"/> Enable	<input type="checkbox"/>

At the bottom of the page, the text 'Matrix Manager Version: 1.6.000000 (2011.11.18 10:02)' is visible. A red box highlights the 'Key serial number: Upgrade' button. A 'Logout' button is located in the bottom left corner, and a 'Save' button is in the bottom right corner.

Chapter 5

Browser / Telnet Operation

Overview

The *Matrix Manager* software can be accessed through most standard web browsers and via Telnet. Once users log in and are authenticated, the browser GUI comes up. The first section explains the login procedure and web browser components. The last section provides details for connecting via Telnet.

Logging In

To log into the Matrix Manager, do the following:

1. Open the browser and specify the IP address of the computer installed with the Matrix Manager software, in the browser's URL location bar.

Note: If the administrator has configured the HTTP or HTTPS port setting as something other than the default, you must include **http://** or **https://** before the IP address, and specify the port number along with the IP address. For example:

```
https://192.168.1.20:8443
```

Where *8443* is the https port number, or *8080* is the http port number, and a colon is inserted between it and the IP address.

2. If a Security Alert box appears, accept the certificate – it can be trusted (See *Trusted Certificates*, page 195 for details). The Login page appears:

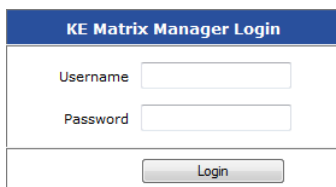

The image shows a web browser window displaying the login page for KE Matrix Manager. The page has a blue header with the text "KE Matrix Manager Login". Below the header, there are two input fields: "Username" and "Password". Below the "Password" field is a "Login" button.

3. Enter the *Username* and *Password*, and click **Login**.

Note: Only administrator accounts can be used to login. Username: *administrator* / Password: *password*. For security purposes, we recommend you change this to something unique.

The Matrix Manager Main Page

After you have successfully logged in, the web browser's main page appears:



Web Components

The web components are described in the table, below:

No.	Item	Description
1	Tab Bar	The tab bar contains the Matrix Manager's main operation categories: Dashboard, Device Management, User Management, System, Logs, and Maintenance.
2	Menu Bar	The menu bar contains operational sub-categories that pertain to the item selected in the tab bar.
3	Sidebar	The Sidebar provides a tree view and listing of items that relate to the various tab bar and menu bar selections. Clicking an item in the Sidebar brings up a page with the details that are relevant to it.
4	Logout	Click this button to log out of your Matrix Manager web session.
5	ATEN Logo	Click this button to open a new browser window that opens on the ATEN website.
6	Welcome Message	If this function is enabled (see <i>Preferences</i> , page 145) a welcome message displays here.
7	Interactive Display Panel	This is your main work area. The screens that appear reflect your menu choices and Sidebar item selection.

Tree View Considerations



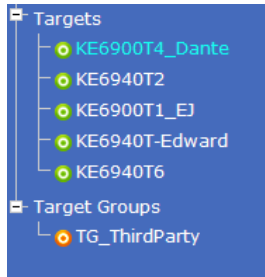



On some pages there will be a sidebar menu with options that can be expanded:



- ◆ A plus (+) sign in front of an item means that there are additional items nested inside of it. Click the plus sign to expand the view and show the nested items.
- ◆ The plus sign changes to a minus sign (-) when an item is expanded. Click the minus sign to collapse the view and hide the nested items.
- ◆ For devices, if the device is on line, its icon is in green; if it is off line, its icon is orange.

The Tab Bar

The functions associated with each of the tabs are explained in the table below:

Icon	Function
 Dashboard	Dashboard: The Dashboard is used to view information about current connections, sessions, and device events. The first page provides an overview and the sidebar provides a link to view details about each section. The Dashboard is discussed on page 61.
 Device Management	Device Management: The Device Management page is used to configure and control the overall operation of the devices added to the Matrix Manager. Device Management is discussed on page 69.
 User Management	User Management: The User Management page is used to create and manage Users and Groups. It is also used to assign permissions to them. User Management is discussed on page 105.
 System	System: The System page is used to configure the Matrix Manager's global settings and setup ANMS authorization and authentication. The System page is discussed on page 120.
 Logs	Logs: The Log page displays the contents of the log file. The Log page is discussed on page 133.
 Maintenance	Maintenance: The Maintenance page is used to install firmware; backup and restore configuration information, install certificates, and set preferences. The Maintenance page is discussed on page 137.

Telnet

The KE6900 / KE6940 can be operated and configured via a remote terminal session using Telnet. This is a useful means for configuring devices when they are first setup and connected to the network.

To log into the KE6900 / KE6940 by means of a Telnet session, do the following:

1. On your computer, open a terminal (command line) session.
2. At the prompt, key in the KE6900 / KE6940's IP address in the following way:

```
telnet [IP address]
```

3. Press **Enter**. The login screen appears. At the login prompt, provide the Password.

Note: The default password for Telnet sessions is **password**.

Configuration Menu

Once a Telnet connection to the KE6900 / KE6940 is established, the device's text-based Configuration Menu comes up, allowing you to select options by entering a number on the following screens:

Main Menu

```
+++++
```

```
KE6900 User Station
```

```
-----
```

```
User Station Configuration
```

```
+++++
```

```
1. Network
```

```
2. Properties
```

```
3. System
```

```
Q. Logout
```

```
Select one:
```

1. Network

+++++

KE6900 User Station

Network Settings

+++++

1. IP Installer [Enabled]
2. DHCP [Disabled]
3. IP Address [172.17.17.34]
4. Subnet Mask [255.255.255.0]
5. Default Gateway [172.17.17.254]

Q. Exit

Select one:

2. Properties

+++++

KE6900 User Station

Device Properties

+++++

1. Mode [Matrix]
2. Transmitter Video IP Address [172.17.17.35]
3. Transmitter Audio IP Address [172.17.17.35]
4. Transmitter USB IP Address [172.17.17.35]
5. Transmitter RS232 IP Address [172.17.17.35]
6. UART Configuration
7. Video [Enabled]
8. Audio [Enabled]
9. USB [Enabled]
10. RS232 [Enabled]
11. KE Manager IP [172.17.17.33]
12. KE Manager Port [9110]
13. Beeper [Enabled]
14. USB Mode [VM]
15. USB Secure Transmit [Disabled]

Q. Exit

Select one:

3. System

+++++

KE6900 User Station

System Setting

+++++

1. Device Name [KE6900R]
2. Device Description [Receiver1]

Device IP Address: 172.17.17.34
Device MAC Address: 00:10:74:A8:01:23
Device FW Version: V1.1.109
Device Serial Number:

3. Password [Enabled]
4. Change Password
5. System Reboot/Reset to Factory Default

Q. Exit

Select one:

This Page Intentionally Left Blank

Chapter 6 Dashboard

Overview

The *Dashboard* tab is used to view events about connections, sessions, online devices and schedules. The *Home* page provides an overview of the information provided in each section. The Sidebar provides a link to each section in the Dashboard.

The Dashboard opens on the *Home* page, as shown here:

The screenshot displays the ALTUSEN Matrix Manager Dashboard. The interface includes a top navigation bar with icons for Dashboard, Device Management, User Management, System, Logs, and Maintenance. A left sidebar contains a 'Home' button and links to Active Connections, Active Sessions, Online User Stations, Online Transmitters, Latest Events, and Schedules. The main content area is titled 'Dashboard' and shows 'Last Redundancy Status: [Primary] [Working]'. It features four data tables:

Channel	Streams	Access Mode	User Station	Username	Start Time	Operation
KE8940T 36	VIA/US	Share	KE8940R 25	administrator	08/12/2015 11:45:23	Disconnect
KE8940T 36	VIA/US	Share	KE8940R 26	administrator	08/12/2015 11:45:23	Disconnect
KE8940T 36	VIA/US	Share	KE8940R 24	administrator	08/12/2015 11:45:23	Disconnect
KE8940T 36	VIA/US	Share	KE8900R 23	administrator	08/12/2015 11:45:23	Disconnect

Username	Service	IP	Login Time	Last Access	User Type
administrator	OSD	192.168.0.23	08/12/2015 09:34:39	08/12/2015 09:34:39	admin
administrator	OSD	192.168.0.26	08/12/2015 09:34:40	08/12/2015 09:34:40	admin
administrator	OSD	192.168.0.23	08/12/2015 09:34:41	08/12/2015 11:45:28	admin
administrator	OSD	192.168.0.24	08/12/2015 09:34:41	08/12/2015 09:34:41	admin
administrator	HTTPS	192.168.0.68	08/12/2015 09:37:06	14:09:26	admin

Name	Model Name	Address	Streams
KE8940R 26	KE8940R	192.168.0.2	VIA/US 0
KE8900R 23	KE8900R	192.168.0.2	VIA/US 3
KE8940R 25	KE8940R	192.168.0.2	VIA/US 5

Name	Model Name	Address	Streams
KE8900T 33	KE8900T	192.168.0.3	VIA/US 3
KE8940T 34	KE8940T	192.168.0.3	VIA/US 4
KE8940T 36	KE8940T	192.168.0.3	VIA/US 6

At the bottom of the page, there are 'Shutdown' and 'Restart' buttons.

At the bottom of the page, click **Shutdown*** to stop the KeManager service, or **Restart** to stop and restart the service. Both options will logout all user web sessions.

Note: Clicking **Shutdown** stops the KeManager service and web sessions will not be available until the KeManager service is restarted.

Active Connections

The *Active Connections* page lets an administrator see the active Channel connections (User Stations connected to Transmitters) and provides information about each of their sessions.

Connections						
Channel	Streams	Access Mode	User Station	Username	Start Time	Operation
KE6940T	V A U S	Share	KE6940R 25	administrator	08/12/2015 11:45:23	Disconnect
KE6940T	V A U S	Share	KE6940R 26	administrator	08/12/2015 11:45:23	Disconnect
KE6940T	V A U S	Share	KE6940R 24	administrator	08/12/2015 11:45:23	Disconnect
KE6940T	V A U S	Share	KE6900R 23	administrator	08/12/2015 11:45:23	Disconnect

The meanings of the headings at the top of the page are straightforward.

- *Channel* refers to the defined Transmitter connection in use by the User Station.
- *Streams* refers to the type of source the connection is streaming: **V**ideo, **A**udio, **U**SB, or **S**erial.
- *Access Mode* refers to the type of access (Exclusive, Occupy, Share, View only) that the User Station is connecting with.
- *User Station* refers to the Receiver that is being used to access the Channel connection.
- *Username* refers to the user that logged into the User Station to establish the connection.
- *Start Time* refers to the date/time the connection between the User Station and Transmitter began.
- *Operation* provides a **Disconnect** button that allows you to disconnect the active connection.

Active Sessions

The *Active Sessions* page shows all of the users that are logged into Matrix Manager and OSD sessions and provides information concerning the “who, where and when” of each session. This page also gives the administrator the option of forcing a user logout by selecting the user and clicking **Kill Session** from the bottom of the page.

Select	Username	Service	IP	Login Time	Last Access	User Type
<input type="checkbox"/>	administrator	OSD	192.168.0.24	08/05/2015 13:28:59	08/05/2015 13:29:39	admin
<input type="checkbox"/>	administrator	OSD	192.168.0.25	08/05/2015 13:29:02	08/05/2015 13:29:39	admin
<input type="checkbox"/>	administrator	OSD	192.168.0.26	08/05/2015 13:45:17	08/05/2015 13:45:17	admin
<input type="checkbox"/>	administrator	OSD	192.168.0.23	08/05/2015 15:26:27	08/05/2015 15:49:54	admin
<input type="checkbox"/>	administrator	HTTPS	192.168.0.69	08/05/2015 16:14:36	08/07/2015 16:18:00	admin

The meanings of the headings at the top of the page are straightforward.

- ♦ *Select* allows you to check boxes and use the **Kill Session** button at the bottom of the page to force users to logout.
- ♦ *Username* refers to the user that logged into the User Station to establish the connection.
- ♦ *Service* refers to how the user logged into their session – via *Matrix Manger* or *OSD*.
- ♦ *IP* refers to the IP address of the device from which the user has logged in.
- ♦ *Login Time* refers to the date/time that the user logged into the Matrix Manager or OSD session.
- ♦ *Last Access* refers to the last time the user session was active and in use.
- ♦ *User Type* refers to the account type that the user is logged in with.

Online User Stations

The *Online User Stations* page lets the administrator see all of the Receivers that are currently available on the network and provides information about each device.

User Stations						
ID	Name	Model Name	Status	Address	Streams	
001074A801060000	KE6940R 26	KE6940R	On	192.168.0.26	V A U S	
001074A801030000	KE6900R 23	KE6900R	On	192.168.0.23	V A U S	
001074A801050000	KE6940R 25	KE6940R	On	192.168.0.25	V A U S	
001074A801040000	KE6940R 24	KE6940R	On	192.168.0.24	V A U S	

The meanings of the headings at the top of the page are straightforward.

- ◆ *ID* refers to the identification number assigned by the system.
- ◆ *Name* refers to the name entered on the User Stations *System* page.
- ◆ *Model Name* refers to the Receiver model number.
- ◆ *Status* refers to the User Station's online status.
- ◆ *Address* refers to the IP address of the User Station.
- ◆ *Streams* refers to the source type that the User Station is configured to stream: **Video, Audio, USB, and Serial.**

Online Transmitters

The *Online Transmitters* page lets the administrator see all of the Transmitters that are currently available on the network and provides information about each device.

Transmitters						
ID	Name	Model Name	Status	Address	Streams	
001074A801060000	KE6940T 26	KE6940T	On	192.168.0.6	V A U S	
001074A801030000	KE6900T 23	KE6900T	On	192.168.0.3	V A U S	
001074A801050000	KE6940T 25	KE6940T	On	192.168.0.5	V A U S	
001074A801040000	KE6940T 24	KE6940T	On	192.168.0.4	V A U S	

The meanings of the headings at the top of the page are straightforward.

- ♦ *ID* refers to the identification number assigned by the system.
- ♦ *Name* refers to the name entered on the Transmitter's *System* page.
- ♦ *Model Name* refers to the Transmitter model number.
- ♦ *Status* refers to the Transmitter's online status.
- ♦ *Address* refers to the IP address of the Transmitter.
- ♦ *Streams* refers to the source type that the Transmitter is configured to stream: **V**ideo, **A**udio, **U**SB, or **S**erial.

Latest Events

The *Latest Events* page lets the administrator see the most recent Dashboard events that relate to the current connections and sessions, and provides details about each.



Latest Events				
Time	User	Severity	Device	Log Information
03/26/2014 14:03:35		Information		Session created(Sessionid=***** 10.3.41.62.
03/26/2014 14:03:35	administrator	Information		User login succeeded(username=administrator).
03/26/2014 14:02:06		Error		Cannot find the KE authentication key.
03/26/2014 13:40:19		Information		Session created(Sessionid=***** 10.3.41.62.
03/26/2014 13:40:19	administrator	Information		User login succeeded(username=administrator).
03/26/2014 13:18:38		Error		Cannot find the KE authentication key.
03/26/2014 12:35:42		Error		Cannot find the KE authentication key.
03/26/2014 12:00:43	administrator	Information		User logout(username=administrator).
03/26/2014 12:00:43		Information		Session terminated normally(Sessionid=*****).
03/26/2014 12:00:43	administrator	Information		User logout(username=administrator).
03/26/2014 11:56:12		Information		Session created(Sessionid=***** 10.3.41.62.
03/26/2014 11:56:12	administrator	Information		User login succeeded(username=administrator).
03/26/2014 11:52:23		Error		Cannot find the KE authentication key.
03/26/2014 11:51:39		Error		System will reboot in 10 seconds.
03/26/2014 11:51:34		Information		Session created(Sessionid=***** 10.3.41.62.
03/26/2014 11:51:34	administrator	Information		User login succeeded(username=administrator).
03/26/2014 11:49:02		Error		Cannot find the KE authentication key.
03/26/2014 11:47:19	administrator	Information		User login succeeded(username=administrator).
03/26/2014 11:47:19		Information		Session created(Sessionid=***** 10.3.41.62.
03/26/2014 11:47:11	administrator	Information		User logout(username=administrator).
03/26/2014 11:47:11		Information		Session terminated normally(Sessionid=*****).

The meanings of the headings at the top of the page are straightforward.

- ◆ *Time* refers to the date and time that the event occurred.
- ◆ *User* refers to the username that the event relates to. If no username appears, the event is general system information.
- ◆ *Severity* refers to the event's severity type: Information, Error, or Warning
- ◆ *Device* refers to the Transmitter or User Station that relates to the event. If no device is listed the event refers to the Matrix Manager.
- ◆ *Log Information* provides detailed information about each event.

Schedule

The *Schedule* page lets the administrator see all of the Profiles and Video Walls that are scheduled to activate.

Profile/Video Walls ↓	Routine Type	Day	Start Date	End Date	Connect Time	Disconnect Time	Apply	Operation
5	Once	-	2015-08-28	2015-08-28	00:00	01:00	08/28/2015 00:00:00	 Delete
1	Every 1 month(s)	11	2015-08-28	2015-10-23	00:00	01:00	09/11/2015 00:00:00	 Delete
7	Every 1 week(s)	Sunday	2015-08-27	2015-09-16	00:00	02:00	08/30/2015 00:00:00	 Delete

The meanings of the headings at the top of the page are straightforward.

- ◆ *Profiles/Video Walls* refers to the ID number created for the Profile or Video Wall schedule.
- ◆ *Routine Type* refers to how often the Profile or Video Wall is scheduled to repeat.
- ◆ *Day* refers to either the day of a week (Monday to Sunday) or a day of the month that the Profile or Video Wall is scheduled to run.
- ◆ *Start Date* refers to the date that the Profiles or Video Wall is scheduled to start.
- ◆ *End Date* refers to the date that the Profile or Video Wall is scheduled to end.
- ◆ *Connect Time* refers to the time of day that the Profile or Video Wall is scheduled to make its connection(s).
- ◆ *Disconnect Time* refers to the time of day that the Profile or Video Wall is scheduled to disconnect its connection(s).
- ◆ *Apply* refers to the date and time when the Profile or Video Wall schedule was created.
- ◆ *Operation* provides a **Delete** button that can be used to permanently delete the Profile or Video Wall schedule.

This Page Intentionally Left Blank

Chapter 7

Device Management

Overview

The *Device Management* tab contains five menu bar items: **User Stations**, **Transmitters**, **Channels**, **Profiles** and **Video Wall**. Each page provides a way to add, configure and schedule the Transmitters/Receivers connections. Before Transmitters and Receivers can be added they must be connected to the network and have an IP address.

The Device Management tab opens on the *User Stations* page, as shown here:

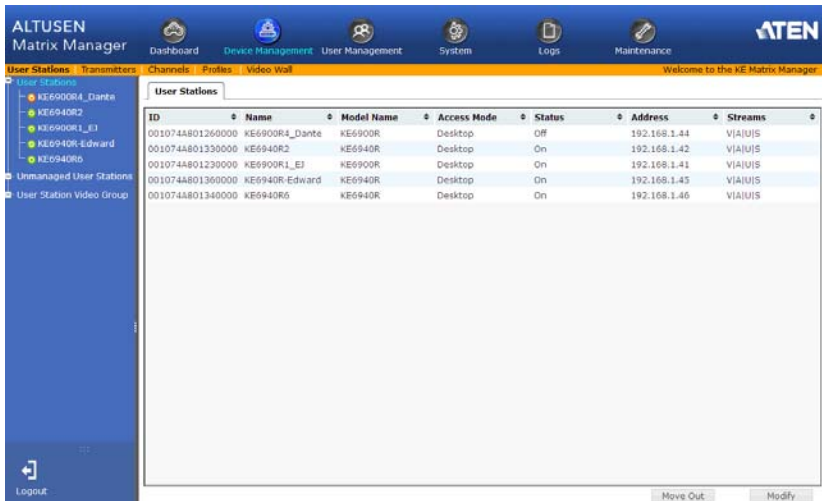

The screenshot shows the ALTUSEN Matrix Manager interface. The top navigation bar includes 'Dashboard', 'Device Management', 'User Management', 'System', 'Logs', and 'Maintenance'. The 'Device Management' tab is active, and the 'User Stations' sub-tab is selected. The main content area displays a table of user stations.

ID	Name	Model Name	Access Mode	Status	Address	Streams
0010744801260000	KE6900R4_Dante	KE6900R	Desktop	Off	192.168.1.44	VIAIUIS
0010744801330000	KE6940R2	KE6940R	Desktop	On	192.168.1.42	VIAIUIS
0010744801230000	KE6900R1_EJ	KE6900R	Desktop	On	192.168.1.41	VIAIUIS
0010744801360000	KE6940R-Edward	KE6940R	Desktop	On	192.168.1.43	VIAIUIS
0010744801340000	KE6940R6	KE6940R	Desktop	On	192.168.1.46	VIAIUIS

User Stations

The *User Stations* page allows you to add and configure Receivers. The Sidebar provides three menu options: **User Stations**, **Unmanaged User Stations** and **User Station Video Group**. User Stations are the Receivers that have been added to the Matrix Manager. Unmanaged User Stations are Receivers that have been found on the network but haven't been added to the Matrix Manager. To discover a Receiver, it must be connected to the network and have an IP address. User Station Video Group lists Transmitters that have been grouped to share the video from one computer.

Click **User Stations** from the menu bar and the following screen appears:

ID	Name	Model Name	Access Mode	Status	Address	Streams
0010744801260000	KE6900R4_Dante	KE6900R	Desktop	Off	192.168.1.44	VIAIUS
0010744801330000	KE6940R2	KE6940R	Desktop	On	192.168.1.42	VIAIUS
0010744801230000	KE6900R1_E3	KE6900R	Desktop	On	192.168.1.41	VIAIUS
0010744801360000	KE6940R-Edward	KE6940R	Desktop	On	192.168.1.45	VIAIUS
0010744801340000	KE6940R6	KE6940R	Desktop	On	192.168.1.46	VIAIUS

The main page provides an overview of each *User Station*. The Sidebar provides a link with a more detailed view of each.

The meanings of the headings at the top of the page are straightforward.

- ♦ *ID* refers to the identification number assigned by the system.
- ♦ *Name* refers to the name entered on the User Stations's *System* page.
- ♦ *Model Name* refers to the Receiver model number.
- ♦ *Access Mode* refers to the User Station's mode set in the *Properties*.
- ♦ *Status* refers to the User Station's online status.
- ♦ *Address* refers to the IP address of the User Station.
- ♦ *Streams* refers to the source type that the User Station is configured to stream: **Video**, **Audio**, **USB**, and **Serial**.

Adding a User Station

To add a User Station, do the following:

1. From *Unmanaged User Stations*, select a User Station and click **Add in**:

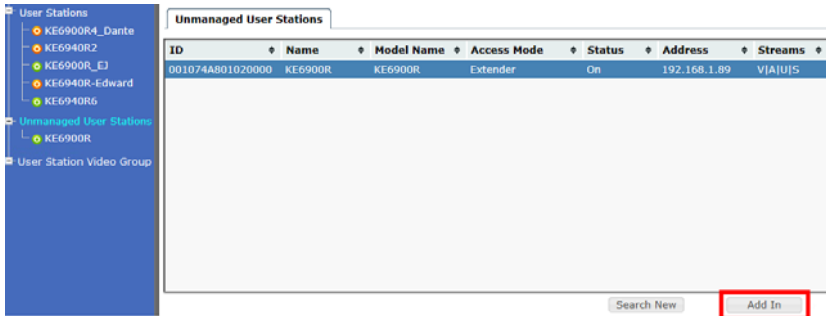

or click **Search New**:

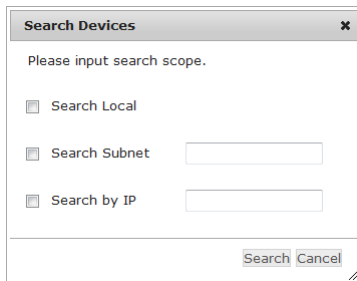

You can search for a device by *Local*, *Subnet*, or *IP* address. Select a scope, enter the information and click **Search**.

2. Once added, the User Station appears on the *User Stations* main page and in Sidebar menu:

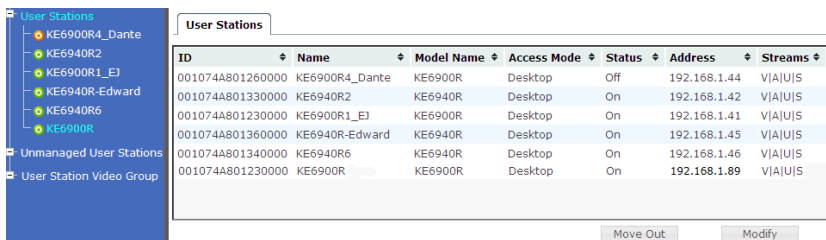

Configuring a User Station

A User Station's settings can be modified from the *User Stations* main page. Changes that are saved here are then updated on the Receiver across the network. To configure a User Station:

1. Select a User Station and click **Modify**.

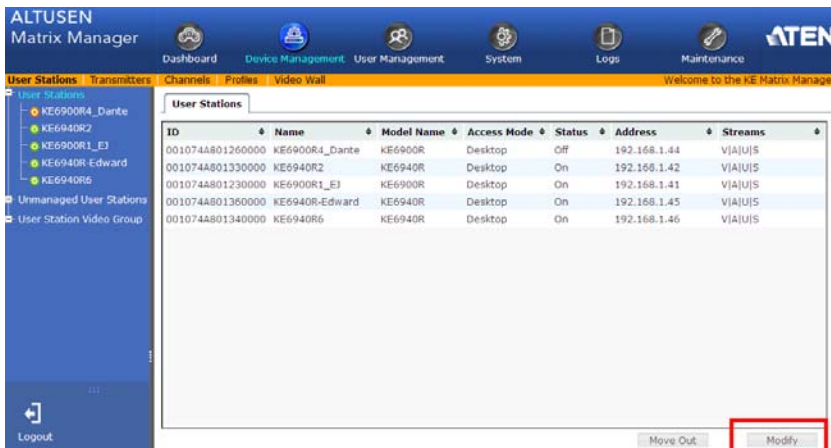

2. The **Network** tab appears with the User Station's IP address settings:

Network Properties System

IP Installer

Enabled View Only Disabled

Network Configuration

Obtain IP address automatically

Set IP address manually

IP Address:

Subnet Mask:

Default Gateway:

Item	Description
IP Installer	The IP Installer is an external Windows-based utility for assigning IP addresses to the device. Click one of the radio buttons to select Enable , View Only , or Disable for the IP Installer utility. See <i>IP Installer</i> , page 194 for details. For security, we strongly recommend that you set this to View Only or Disable after each use.

Item	Description
Network Configuration	<p>For dynamic IP address assignment, select the Obtain IP address automatically radio button.</p> <p>To specify a fixed IP Address, Subnet Mask, and Default Gateway select the Set IP address manually radio button and fill in the fields with values appropriate for your network.</p> <p>For information to configure the network settings locally on the device see <i>Network Configuration</i>, page 23.</p>

3. Click the **Properties** tab to configure the User Station's properties:

The screenshot shows the 'Properties' configuration window for a User Station. It includes sections for Mode (Extender or Matrix), RS232 Settings (Baud Rate, Parity, Data Bits, Stop Bits, Flow Control), Manager Address (Manager IP, Manager Port, User Station Login Required), Beeper (Enable), and USB Mode (Virtual Media or Generic USB device, Encryption, Enable).

Item	Description
Mode	<p>Select Extender mode for simple one-to-one (Transmitter to User Station) setups that are managed mostly with the Receiver's OSD menu.</p> <p>Select Matrix mode to manage devices and connections from the Matrix Manager. This mode is for advanced setup and administration of Transmitter to User Station connections via the Matrix Manger browser UI. (See <i>Channel Connections</i>, page 87)</p>
Properties	<p>If you selected Extender mode (above) set the Transmitter IP address for the User Station's Video, Audio, USB, and RS232 source signals.</p> <p>If you selected Matrix mode (above) the <i>Properties</i> will be grayed out. Use Channels to configure the Transmitter connections. (See <i>Channel Connections</i>, page 87)</p>

Item	Description
RS-232 Settings	Configure the settings for the serial device the User Station will be connecting to. The default settings are: Baud Rate: 9600 Parity: None Data Bits: 8 bits Stop bits: 1 bit Flow Control: None
Enable Media	Select which source type the User Station can stream : Video, Audio, USB, and RS232.
Manager Address	Set the IP address and Port number of the computer running the Matrix Manager software. The default port number is 9110.
Login Required	Check this box to require a username and password on the User Station's OSD to access the <i>Connection Page</i> (see page 40). Note: WARNING! If you uncheck <i>Login Required</i> you must select an Anonymous User in <i>Global Settings</i> . Otherwise a system login error may occur on the User Station's OSD. (See <i>User Station Login Settings</i> , page 122)
Beeper	Check this box for the Receiver to beep when configuration changes are made.
USB Mode	Select the type of USB device you will connect to the USB ports: VM (Virtual Media): Select this option only if you are plugging a USB disk drive (including USB HDD/optical disk) into the USB ports. This will give you the highest data transfer speeds but will not allow other USB devices to work when plugged into the USB ports. Generic USB device: Use this option to plug USB peripherals into the USB ports. This option also allows a keyboard and mouse with special functions to plug into the USB ports for console use. Use this only if the special functions of the keyboard or mouse are required but do not work when plugged into the console ports. When the keyboard and mouse are plugged into the USB ports, they will not work within the OSD menus. To work within the OSD menus, the keyboard and mouse must be plugged into the console ports. Encryption: Check this box to encrypt USB disk drives plugged into the USB ports.

4. Click the **System** tab to configure the general settings:

The screenshot shows a configuration interface with three tabs: Network, Properties, and System. The System tab is active. It contains three sections:

- General:** Fields for Name (KE6900R4_Dante), Location, Description, IP Address (192.168.1.44), MAC Address (00:10:74:a8:01:26), F/W Version (1.1.105), Model Name (KE6900R), and MFG.
- Reboot:** A checkbox for "Reset to factory default" and a "Reboot" button.
- User Station Password Change:** A checkbox for "Enable Password" and three password input fields labeled "Old Password:", "New Password:", and "Confirm Password:".

Item	Description
General	Enter the Name , Location , and Description of the User Station. This section also displays the User Station's <i>IP Address</i> , <i>F/W Version</i> , <i>Model Name</i> , <i>MAC Address</i> and <i>MFG</i> *. Note: The MFG number (manufacturing number) is an internal serial number for our factory and technical support staff to identify products. This number does not affect any product's warranty. If your product needs after-sales services, you may provide the MFG Number to our sales or technical support staff to identify the product and model number.
Reboot	Check the box and click Reboot to reset the User Station's settings back to the factory default. All custom settings will be lost.
User Station Password Change	Check Enable to require a password to access the User Station's OSD configuration screens (see page 29). Enter the <i>Old Password</i> , enter a <i>New Password</i> , and confirm the new password in the <i>Confirm Password</i> box.

5. After entering the information, click **Save**.

Deleting a User Station

To delete a User Station:

1. Select the User Station you want to delete.
2. Click **Move Out**.

The device list updates with the remaining User Stations. The User Station you deleted will appear on the *Unmanaged User Stations* main page and Sidebar menu.

User Station Video Group

Creating a *User Station Video Group* allows you to cascade up to four Transmitters connected to separate video cards on a computer and share the video with four or eight (dual display) User Stations with the first having keyboard and mouse access. The image below provides an example of the setup without the actual physical connections or possible device connections.

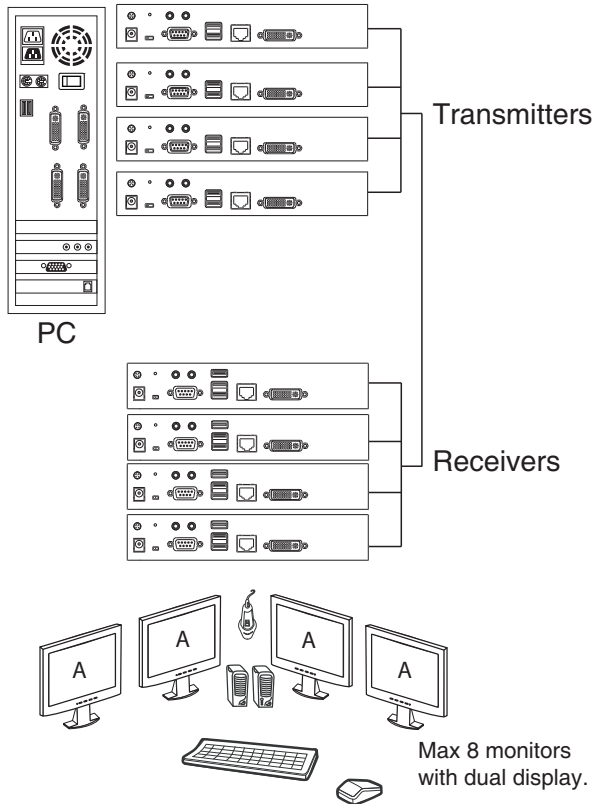

Note: User Station Video Groups cannot be used with a Video Wall or Profile.

Hardware Setup

1. Connect each Transmitter to the network and to a DVI port on the computer.
2. Connect one Transmitter's – console & KVM ports to their respective device (keyboard/mouse/computer).

3. Setup the Receivers as you normally would. All Receivers can have a keyboard and mouse but only one (Video 1) can work on the computer for the group.
4. Note the Receiver and Transmitter with keyboard and mouse access (to the computer) so they can be set in the *User Station Video Group* (as **Video 1**) and in the *Channel* (as **KVM Transmitter**).

Adding a User Station Video Group

1. Add the User Stations (*Adding a User Station*, page 71) and Transmitters (*Adding a Transmitter*, page 81) to the Matrix Manager.
2. On the left Sidebar select **User Station Video Group**.



3. Provide a **Name** and **Description** for the group.

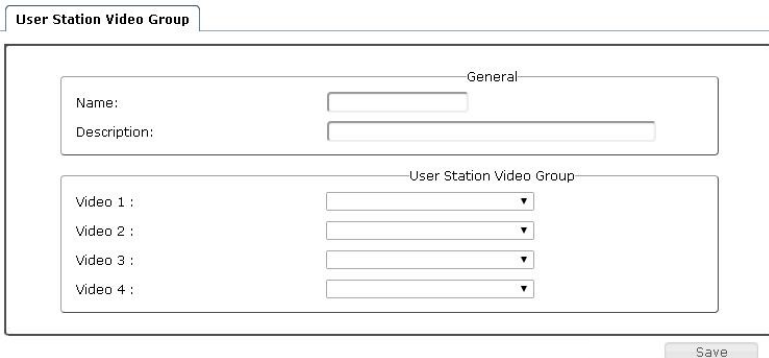

4. Use the **Video 1** drop-down menu to select the Receiver that will have keyboard and mouse access to the computer.

Note: All Receivers can switch KVM access to other Transmitters but only **Video 1** has keyboard and mouse access to the computer for the group.

5. Use the **Video 2**, **Video 3** and **Video 4** drop-down menus to select the other Receivers for the group.
6. Click **Save**. The group appears in the Sidebar.
7. On the menu bar, go to **Channels**.
8. Add a new **Channel**.

The screenshot shows a web-based configuration interface for a Channel. It has three tabs: 'Channel Info', 'Groups', and 'Permissions'. The 'Channel Info' tab is selected. The interface is divided into three main sections:

- General:** Contains three text input fields: 'Name:', 'Location:', and 'Description:'.
- Source Stream:** Contains seven dropdown menus: 'KVM Transmitter:', 'Video 2:', 'Video 3:', 'Video 4:', 'Audio Transmitter:', 'USB Transmitter:', and 'Serial Transmitter:'.
- Allowed Access Mode:** Contains four checkboxes: 'View Only', 'Share', 'Occupy', and 'Exclusive'.

9. Set the **Source Stream** to map the Transmitters to the *User Station Video Group* Receivers, as such: KVM Transmitter → Video 1; Video 2 → Video 2; Video 3 → Video 3; Video 4 → Video 4.
 - ◆ Use the **KVM Transmitter** drop-down menu to select the Transmitter connected to the computer's keyboard and mouse ports.
 - ◆ Use the **Video 2**, **Video 3** and **Video 4** drop-down menus to select the other Transmitters connected to the computer.
 - ◆ Use the **Audio**, **USB** and **Serial** drop-down menus to select the Transmitter for each source signal. The Transmitter selected sends the signal to the Receiver set with the same Video #.
10. Configure the remaining Channel settings (see *Adding a Channel*, page 89).
11. Click **Save**.

Transmitters

The *Transmitters* page allows you to add, configure, and delete Transmitters. The Sidebar provides two options: **Transmitters** and **Unmanaged Transmitters**. Unmanaged Transmitters are Transmitters on the network that haven't been added to the Matrix Manager. For the Matrix Manager to discover a Transmitter, it must be connected to the local network with an IP address.

Click **Transmitters** from the menu bar and the following screen appears:

ID	Name	Model Name	Access Mode	Status	Address	Streams
001074A901260000	KE6900T4_Dante	KE6900T	Desktop	Off	192.168.1.24	VIAIUIS
001074A901330000	KE6940T2	KE6940T	Desktop	On	192.168.1.22	VIAIUIS
001074A901230000	KE6900T1_EJ	KE6900T	Desktop	On	192.168.1.21	VIAIUIS
001074A901360000	KE6940T-Edward	KE6940T	Desktop	On	192.168.1.23	VIAIUIS
001074A901340000	KE6940T6	KE6940T	Desktop	On	192.168.1.26	VIAIUIS

The main page provides an overview of each *Transmitter*. The Sidebar provides a link with a more detailed view of each.

The meanings of the headings at the top of the page are straightforward.

- ◆ *ID* refers to the identification number assigned by the system.
- ◆ *Name* refers to the name entered on the Transmitter's *System* page.
- ◆ *Model Name* refers to the Transmitter's model number.
- ◆ *Access Mode* refers to the Transmitter's mode set in the *Properties*.
- ◆ *Status* refers to the Transmitter's online status.
- ◆ *Address* refers to the IP address of the Transmitter.
- ◆ *Streams* refers to the source type that the Transmitter is configured to stream: **Video**, **Audio**, **USB**, or **Serial**.

Adding a Transmitter

To add a Transmitter, do the following:

1. From *Unmanaged Transmitters*, select a Transmitter and click **Add in**:

ID	Name	Model Name	Access Mode	Status	Address	Streams
001074A901360000	KE6940T-Edward	KE6940T	Desktop	On	192.168.1.25	V A U S

Buttons: Search New, Add In

or click **Search New**:

Search Devices

Please input search scope.

Search Local

Search Subnet

Search by IP

Search Cancel

You can search for a device by *Local*, *Subnet*, or *IP* address. Select a scope, enter the information and click **Search**.

2. Once added, the Transmitter appears on the *Transmitters* main page and Sidebar menu:

ID	Name	Model Name	Access Mode	Status	Address	Streams
001074A901260000	KE6900T4_Dante	KE6900T	Desktop	Off	192.168.1.24	V A U S
001074A901330000	KE6940T2	KE6940T	Desktop	On	192.168.1.22	V A U S
001074A901230000	KE6900T1_EJ	KE6900T	Desktop	On	192.168.1.21	V A U S
001074A901360000	KE6940T-Edward	KE6940T	Desktop	On	192.168.1.25	V A U S
001074A901340000	KE6940T6	KE6940T	Desktop	On	192.168.1.26	V A U S

Buttons: Move Out, Modify

Configuring a Transmitter

A Transmitter's settings can be modified from the *Transmitters* main page. Changes that are saved are updated on the Transmitter device across the network. To configure a Transmitter:

1. Select a Transmitter and click **Modify**.

The screenshot shows the ALTUSEN Matrix Manager web interface. The top navigation bar includes Dashboard, Device Management, User Management, System, Logs, and Maintenance. The main content area displays a table of Transmitters. The table has columns for ID, Name, Model Name, Access Mode, Status, Address, and Streams. The data rows are as follows:

ID	Name	Model Name	Access Mode	Status	Address	Streams
001074A901260000	KE6900T4_Dante	KE6900T	Desktop	Off	192.168.1.24	VIAUIJS
001074A901330000	KE6940T2	KE6940T	Desktop	On	192.168.1.22	VIAUIJS
001074A901230000	KE6900T1_EJ	KE6900T	Desktop	On	192.168.1.21	VIAUIJS
001074A901360000	KE6940T-Edward	KE6940T	Desktop	On	192.168.1.25	VIAUIJS
001074A901340000	KE6940T6	KE6940T	Desktop	On	192.168.1.26	VIAUIJS

Buttons for 'Move Out' and 'Modify' are visible at the bottom right of the table.

2. The **Network** tab appears with the Transmitter's IP address settings:

The screenshot shows the 'Network' configuration tab for a transmitter. It includes the following settings:

- IP Installer:** Radio buttons for Enabled (selected), View Only, and Disabled.
- Network Configuration:** Radio buttons for Obtain IP address automatically and Set IP address manually (selected).
- IP Address:** Text input field containing 192.168.1.44.
- Subnet Mask:** Text input field containing 255.255.255.0.
- Default Gateway:** Text input field containing 192.168.1.254.

Item	Description
IP Installer	<p>The IP Installer is an external Windows-based utility for assigning IP addresses to the device. Click one of the radio buttons to select Enable, View Only, or Disable for the IP Installer utility. (See <i>IP Installer</i>, page 194)</p> <p>For security, we strongly recommend that you set this to View Only or Disable after each use.</p>

Item	Description
Network Configuration	<p>For dynamic IP address assignment, select the Obtain IP address automatically radio button.</p> <p>To specify a fixed IP Address, Subnet Mask, and Default Gateway, select the Set IP address manually radio button and fill in the fields with values appropriate for your network.</p> <p>For information to configure the network settings locally on the device see <i>Network Configuration</i>, page 23.</p>

3. Click the **Properties** tab to configure the Transmitter's properties:

Network
Properties
System

Mode

Extender Matrix

RS232 Settings

Baud Rate:

Parity:

Data Bits:

Stop Bits:

Flow Control:

Properties

Port OS:

OS Language:

Enable Multicast Video

Enable Multicast Audio

EDID Mode Selection:

Enable Media

Video Audio USB RS232

Manager Address

Manager IP: Manager Port:

Transmitter Video Setting

Video Type: Video Quality:

Color Depth: Background Refresh:

Bandwidth Limit:

Beeper Enable

Occupy Timeout sec(1-240)

Item	Description
Mode	<p>Select Extender mode for simple one-to-one (Transmitter to User Station) setups that are managed with the Receiver's OSD menu.</p> <p>Select Matrix mode to manage devices and connections from the Matrix Manager. This mode is for advanced administration of Transmitter to User Station connections. (See <i>Channel Connections</i>, page 87)</p>

Item	Description
Properties	<p>Port OS: Use the drop-down menu to select the operating system of the computer connected to the Transmitter.</p> <p>OS Language: Use the drop-down menu to select the operating system language of the computer connected to the Transmitter.</p> <p>Enable Multicast Video: Check this box to allow a broadcast of the Transmitter's video signal to be sent to multiple User Stations.</p> <p>Enable Multicast Audio: Check this box to allow a broadcast of the Transmitter's audio signal to be sent to multiple User Stations.</p> <p>EDID Mode Selection: EDID contains a display's basic information and is used by the source device to utilize the best resolution across different monitors. Select how you want the source device to acquire the display's EDID:</p> <ul style="list-style-type: none"> ◆ Default: EDID is set to the default ATEN configuration. ◆ Auto: Checks the EDID of all connected displays and uses the best resolution for all displays. ◆ Manual: Manually set the EDID configuration from the User Station's OSD (see <i>Manual EDID</i>, page 42). ◆ Remix: Checks the EDID of all connected displays and the source device uses the best common resolution for all displays.
Enable Media	Select which source type the Transmitter can stream: Video, Audio, USB and RS232.
RS232 Settings	<p>Configure the serial device settings for the Transmitter. The default settings are:</p> <p>Baud Rate: 9600</p> <p>Parity: None</p> <p>Data Bits: 8 bits</p> <p>Stop bits: 1 bit</p> <p>Flow Control: None</p>
Manager Address	Set the Manger IP address and Manager Port number of the computer running the Matrix Manager software. The default port number is 9110.

Item	Description
Transmitter Video Setting	<p>These refer to the Transmitter's video settings:</p> <p>Video Type: Select the DVI video connector being used by the display: Digital (DVI-D) or Digital (DVI-I).</p> <p>Color Depth: Select the number of bits to use for the color depth: 24, 16, or 8. This is the number of bits used to describe the color of a single pixel. A bit depth determines the number of colors that can be displayed at one time.</p> <p>Bandwidth Limit: Select the maximum bandwidth that the Transmitter can use to transmit video over the network. A lower bandwidth transmits lower quality video; a higher bandwidth sends higher quality video but this can affect network speed.</p> <p>Video Quality: Select the video quality to use. 5 is the highest video quality, and 1 is the lowest video quality. Options are: 1~5.</p> <p>Background Refresh: Sets how often the Transmitter refreshes the background image on the connected display. Options are to refresh every 256,128, 64, 32,16, or 0 frames.</p>
Beeper	Check this box for the Transmitter to beep when a configuration change is made.
Occupy Timeout	Set a time threshold for User Stations whose Access Mode has been set to Occupy If there is no activity from the User Station occupying the port for the amount of time set here, the User Station is timed out and the port is released. The first User Station to send keyboard or mouse input after the port has been released gets to occupy the port. Input a value from 1 to 240 seconds.

4. Click the **System** tab configure the general settings:

Network
Properties
System

General

Name: Location:

Description:

IP Address: 192.168.1.24 MAC Address: 00:10:74:a9:01:26

F/W Version: 1.1.105 Serial Number:

Model Name: KE6900T

Reboot

Reset to factory default

Transmitter Password Change

Enable Password

Old Password:

New Password:

Confirm Password:

Item	Description
General	Enter the Name , Location , and Description of the Transmitter. This section also displays the <i>IP Address</i> , <i>MAC Address</i> , <i>F/W Version</i> , <i>Serial Number</i> , and <i>Model Number</i> .
Reboot	Check the box and click Reboot to reset the Transmitter's settings back to the factory default. All custom settings will be lost.
Transmitter Password Change	Check Enable to require a password to access to the Transmitter's OSD configuration screens (see page 29). Enter the <i>Old Password</i> , enter a <i>New Password</i> , and confirm the new password in the <i>Confirm Password</i> box.

5. After entering the information, click **Save**.

Deleting a Transmitter

To delete a Transmitter:

1. Select the Transmitter you want to delete.
2. Click **Move Out**.

The device list updates with the remaining Transmitters. The Transmitter you deleted will appear on the *Unmanaged Transmitters* main page and Sidebar menu.

Channel Connections

With *Channel* connections a User Station can connect to multiple Transmitters, individually or simultaneously and stream the **Video**, **Audio**, **USB**, and **Serial** source from different Transmitters. For example: you can create a Channel that connects to four Transmitters to access a different source on each computer, as shown below:

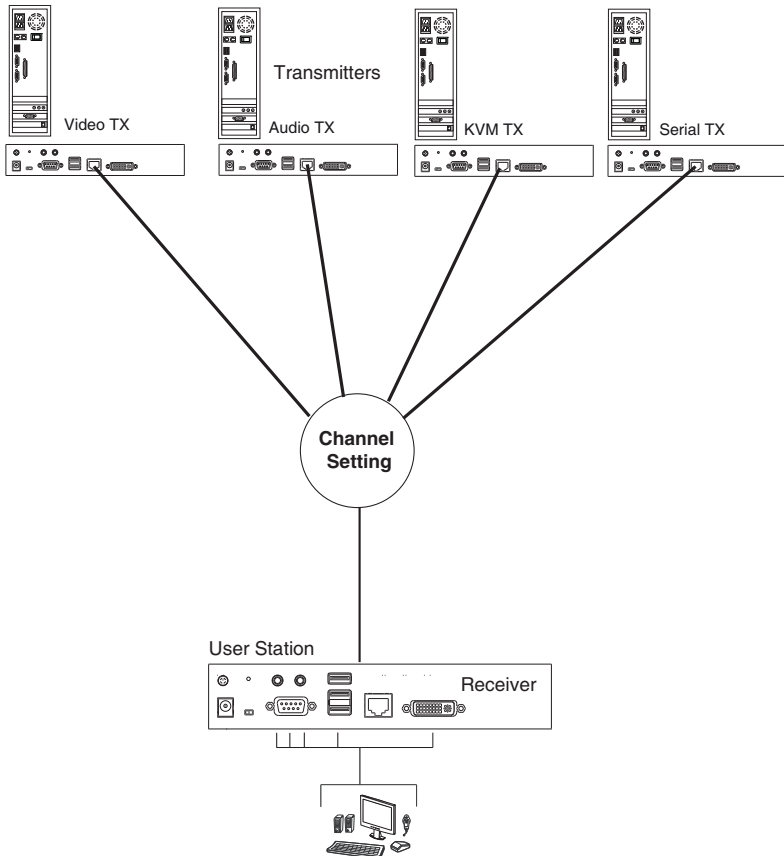

Create Channels to allow User Stations to connect to any Transmitters you have setup- individually or simultaneously. The Channel defines the connection to the sources. At the User Stations you can select the Channel connections you create. To setup Channels: first create a **Channel** that defines the connection, then create a **Profile** to give the *User Station(s)* access to the *Channel*. Instructions are provided on the pages that follow.

Channels

A *Channel* defines the Transmitter connections for a User Station. This allows a User Station to connect to different Transmitters and stream sources from different Transmitters, depending on how the Channel is defined. Once Channels are created you can select them from the User Station's *Connection Page* (see *Connecting*, page 40).

Click **Channels** from the menu bar and the following screen appears:

ID	Name	Bound	Streams	Video TX	Audio TX	USB TX	RS232 TX
0010744901260000	KE6900T4_Dante	YES	V A U S	KE6900T4_Dante	KE6900T4_Dante	KE6900T4_Dante	KE6900T4_Dante
0010744901330000	KE6940T2	YES	V A U S	KE6940T2	KE6940T2	KE6940T2	KE6940T2
0010744901230000	KE6900T1_E3	YES	V A U S	KE6900T1_E3	KE6900T1_E3	KE6900T1_E3	KE6900T1_E3
0010744901380000	KE6940T-Edward	YES	V A U S	KE6940T-Edward	KE6940T-Edward	KE6940T-Edward	KE6940T-Edward
0010744901340000	KE6940T6	YES	V A U S	KE6940T6	KE6940T6	KE6940T6	KE6940T6

The main page provides an overview of each *Channel*. The Sidebar provides a link with a more detailed view of each.

The meanings of the headings at the top of the page are straightforward.

- ♦ *ID* refers to the identification number assigned by the system.
- ♦ *Name* refers to the name entered on the Channel's *Info* page.
- ♦ *Bound* states whether the Channel's connections are all bound to the same Transmitter.
- ♦ *Streams* refers to the source type that the Channel is configured to stream: Video, Audio, USB, or Serial.
- ♦ *Video TX*, *Audio TX*, *USB TX*, *RS232 TX* lists the Transmitter's name for each source stream.
- ♦ Click **Modify** to change the selected Channel's settings.
- ♦ Click **Add** to create a new Channel.
- ♦ Click **Delete** to remove the selected Channel.

Adding a Channel

To add a Channel, do the following:

1. From the *Channels* main page, click **Add**:

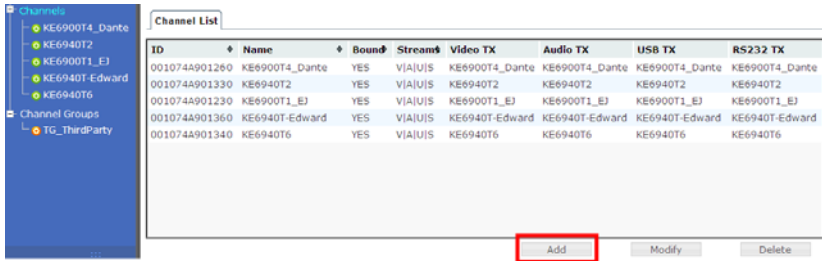

2. The *Channel Info* tab appears with the general settings:

The screenshot shows the 'Channel Info' tab with three sub-tabs: 'Channel Info', 'Groups', and 'Permissions'. The 'Channel Info' sub-tab is active and contains the following sections:

- General:**
 - Name:
 - Location:
 - Description:
- Source Stream:**
 - KVM Transmitter:
 - Video 2:
 - Video 3:
 - Video 4:
 - Audio Transmitter:
 - USB Transmitter:
 - Serial Transmitter:
- Allowed Access Mode:**
 - View Only
 - Share
 - Occupy
 - Exclusive

Item	Description
General	Enter a Name , Location , and Description for the Channel.
Source Stream	Use the drop-down menu to select the Transmitter to use for each of the Channel's source stream: KVM (keyboard/video/ mouse), Audio, USB, and Serial.

Item	Description
Allowed Access Mode	<p>Check the box for the type of access mode you want to allow on this Channel. This defines how the Channel can be accessed when multiple users access it.</p> <p>View Only: Users only have view access to the Channel's video display.</p> <p>Share: Users simultaneously share control over the Channel. Input from the users is placed in a queue and executed chronologically.</p> <p>Occupy: The first user to access the Channel has control over the Channel. However, additional users may view the Channel's video display. If the user who controls the Channel is inactive for longer than the time set in the Timeout box (see <i>Occupy Timeout</i>, page 85), Channel control is transferred to the first user to move the mouse or strike the keyboard.</p> <p>Exclusive: The first user to access the Channel has exclusive control over the Channel. No other users can view the Channel. The Timeout function does not apply to Channels which have this setting.</p>

3. Click the **Groups** tab to add the Channel to Channel Groups:

Select a Channel Group from the *Selected* column and use the **left arrow** to add the Channel to the group. Select a Channel Group from the *Available* column and use the **right arrow** to remove the Channel from the group. See *Channel Groups*, page 92 for details.

4. Click the **Permissions** tab to set the Channels access rights:

Users/Groups	View Only	Share	Occupy	Exclusive
▼ Users				
radius001	<input type="checkbox"/>	<input type="checkbox"/>	<input type="checkbox"/>	<input type="checkbox"/>
test	<input checked="" type="checkbox"/>	<input type="checkbox"/>	<input type="checkbox"/>	<input type="checkbox"/>
user002	<input type="checkbox"/>	<input type="checkbox"/>	<input type="checkbox"/>	<input type="checkbox"/>
user003	<input type="checkbox"/>	<input type="checkbox"/>	<input type="checkbox"/>	<input type="checkbox"/>
▼ Groups				
GP_Test	<input type="checkbox"/>	<input type="checkbox"/>	<input type="checkbox"/>	<input type="checkbox"/>
GP_ThirdParty	<input checked="" type="checkbox"/>	<input type="checkbox"/>	<input type="checkbox"/>	<input type="checkbox"/>

Item	Description
Users/Groups	<p>You can assign individual access rights to Users and Groups for the Channel by checking the appropriate boxes:</p> <p>View Only: Only has view access to the Channel's video display.</p> <p>Share: Can simultaneously share control over the Channel. Input from the users is placed in a queue and executed chronologically.</p> <p>Occupy: The first user to access the Channel has control over the Channel. However, additional users may view the Channel's video display. If the user who controls the Channel is inactive for longer than the time set in the Timeout box (see <i>Occupy Timeout</i>, page 85), Channel control is transferred to the first user to move the mouse or strike the keyboard.</p> <p>Exclusive: The first user to access the Channel has exclusive control over the Channel. No other users can view the Channel. The Timeout function does not apply to Channels which have this setting.</p>

5. After entering the information, click **Save**.

Channel Groups

Channel Groups allow administrators to easily and efficiently manage users and Channels. Since Channel Group access rights apply to any Channel that is a member of the group, administrators need only set them once for the group, instead of having to set them for each Channel individually. Multiple groups can be defined to allow some users access to specific Channels, while restricting other users from accessing them.

Adding a Channel Group

To add a Channel Group, do the following:

1. Select *Channel Groups* from the Channel Sidebar menu, and click **Add**:

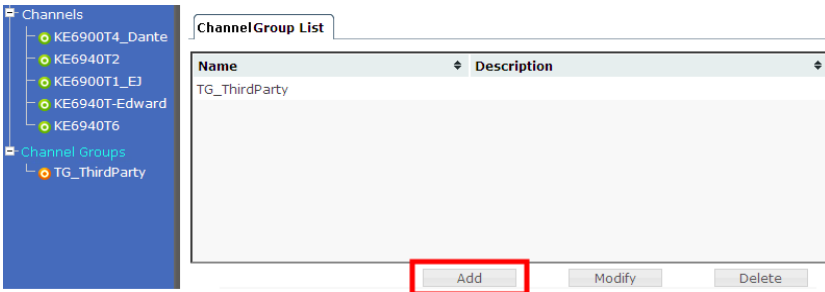

2. The *Channel Group* tab appears with the general settings:

Channel Group Members Permissions

General

Group Name:

Description:

Save

Item	Description
General	Enter a Name and Description for the Channel Group.

- Click the **Members** tab to add Channels to the group:

Select a Channel from the *Selected* column and use the **left arrow** to add it to the group. Select a Channel from the *Available* column and use the **right arrow** to remove it from the group.

- Click the **Permissions** tab to set the group access rights:

Users/Groups	View Only	Share	Occupy	Exclusive
Users				
radius001	<input checked="" type="checkbox"/>	<input type="checkbox"/>	<input type="checkbox"/>	<input type="checkbox"/>
test	<input type="checkbox"/>	<input type="checkbox"/>	<input type="checkbox"/>	<input type="checkbox"/>
user002	<input checked="" type="checkbox"/>	<input type="checkbox"/>	<input type="checkbox"/>	<input type="checkbox"/>
user003	<input checked="" type="checkbox"/>	<input type="checkbox"/>	<input type="checkbox"/>	<input type="checkbox"/>
Groups				
GP_Test	<input type="checkbox"/>	<input type="checkbox"/>	<input type="checkbox"/>	<input type="checkbox"/>
GP_ThirdParty	<input type="checkbox"/>	<input type="checkbox"/>	<input type="checkbox"/>	<input type="checkbox"/>

Item	Description
Users/ Groups	<p>You can assign the access rights to Users and Groups for the Channel Group by checking the appropriate boxes:</p> <p>View Only: Has view access to the Channel video display.</p> <p>Share: Simultaneously share control of the Channel. Input from the users is placed in a queue and executed chronologically.</p> <p>Occupy: The first user to access the Channel has control over the Channel. However, additional users may view the Channel's video display. If the user who controls the Channel is inactive for longer than the time set in the Timeout box (see <i>Occupy Timeout</i>, page 85), Channel control is transferred to the first user to move the mouse or strike the keyboard.</p> <p>Exclusive: The first user to access the Channel has exclusive control. No other users can view the Channel. The Timeout function does not apply to Channels which have this setting.</p>

- After entering the information, click **Save**.

Profiles

Profiles are created for Channels to allow User Station access to the connection. Create a Profile for a Channel and assign access for each User Station.

Click **Profiles** from the menu bar and the following screen appears:

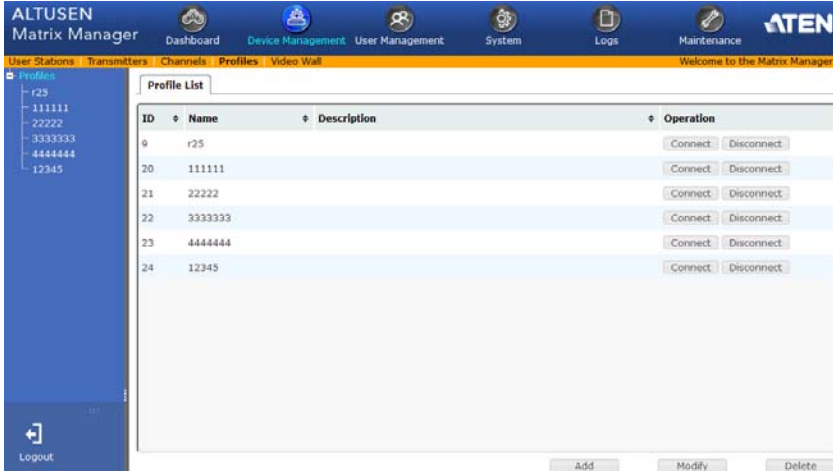

The main page provides an overview of each *Profile*. The Sidebar provides a link with a more detailed view of each Profile.

The meanings of the headings on the *Profile List* are straightforward.

- ♦ *ID* refers to the identification number assigned by the system.
- ♦ *Name* refers to the name entered on the Profile's *Settings* page.*
- ♦ *Description* refers to the description entered on the Profile's *Settings* page.
- ♦ *Operation* allows you to click **Connect** to send a Profile's settings to the Transmitters and User Stations, or **Disconnect** to remove a Profile's settings from the Transmitters and User Stations.
- ♦ Click **Add** to create a new Profile.
- ♦ Click **Modify** to change the selected Profile's settings.
- ♦ Click **Delete** to remove the selected Profile.

Note: Profiles and Video Walls can not share the same name.

Adding a Profile

To add a Profile, do the following:

- From the *Profile* main page, click **Add**:

The screenshot shows the 'Profile List' page. On the left is a sidebar with a tree view of profiles: r25, 111111, 22222, 3333333, 4444444, and 12345. The main area contains a table with columns: ID, Name, Description, and Operation. The table lists profiles with IDs 9 through 24. Each row has 'Connect' and 'Disconnect' buttons. Below the table are three buttons: 'Add' (highlighted with a red box), 'Modify', and 'Delete'.

ID	Name	Description	Operation
9	r25		Connect Disconnect
20	111111		Connect Disconnect
21	22222		Connect Disconnect
22	3333333		Connect Disconnect
23	4444444		Connect Disconnect
24	12345		Connect Disconnect

- The *Profile Settings* tab appears with the Profile and access settings:

The screenshot shows the 'Profile Settings' page. It has tabs for 'Profile Settings', 'Schedule', and 'Permissions'. A filter 'Filter: User Station | Channel' is visible. The form includes:

- Name: [text input]
- Description: [text input]
- Access Mode: View Only Share Occupy Exclusive
- Permission Check: User stations are required login before connecting
- Lock OSD: Lock OSD when connecting
- Channel selection table:

 Below the table are 'Connect', 'Disconnect', and 'Save' buttons.

Channel	KE6900R 23	KE6940R 24	KE6940R 25	KE6940R 26
KE6900T 33	<input type="checkbox"/>	<input type="checkbox"/>	<input type="checkbox"/>	<input type="checkbox"/>
KE6940T 34	<input type="checkbox"/>	<input type="checkbox"/>	<input type="checkbox"/>	<input type="checkbox"/>
KE6940T 35	<input type="checkbox"/>	<input type="checkbox"/>	<input type="checkbox"/>	<input type="checkbox"/>
KE6940T 36	<input type="checkbox"/>	<input type="checkbox"/>	<input type="checkbox"/>	<input type="checkbox"/>

Item	Description
Name/ Description	Enter a Name and Description for the Channel.

Item	Description
Access Mode	<p>This defines how the Channel in the Profile can be accessed by User Stations when multiple users access it.</p> <p>View Only: Users only have view access to the Channels video display.</p> <p>Share: Users simultaneously share control over the Channel. Input from the users is placed in a queue and executed chronologically.</p> <p>Occupy: The first user to access the Channel has control over the Channel. However, additional users may view the Channel's video display. If the user who controls the Channel is inactive for longer than the time set in the Timeout box (see <i>Occupy Timeout</i>, page 85), Channel control is transferred to the first user to move the mouse or strike the keyboard.</p> <p>Exclusive: The first user to access the Channel has exclusive control over the Channel. No other users can view the Channel. The Timeout function does not apply to Channels which have this setting.</p>
Permission Check	<p>Checking this box requires a user with access rights (permissions) to be logged into the User Station's OSD when the Profile attempts to connect. If a user is not logged into the OSD or the user account does not have permission to make the Profile connection, the connection fails and will not re-connect.</p>
Lock OSD	<p>Checking this box will lock the User Station's OSD so that it can not be invoked while the Profile is connected. All mouse/keyboard functions work on the computer but the OSD can not be accessed.</p>
Channel	<p>This table lists all the Channels and User Stations available. Checking a box enables the User Station to use the Channel connection, listed to the left. The Channel will appear on the User Station's Connection Page (See <i>Connections Page</i>, page 41), allowing you to connect to it.</p>
Connect	<p>Clicking Connect will send the Profile settings to the Transmitters and User Stations and will connect the devices accordingly.</p>

- Click the **Schedule** tab if you want to schedule a time for the Profile to connect. A pop-up window appears:

The screenshot shows a 'Schedule' dialog box with the following fields and options:

- Routine Type:** A dropdown menu currently set to 'Once'.
- Start Date:** A date input field containing '08/18/2015'.
- End Date:** A date input field containing '08/20/2015'.
- Connect Time(HH:MM):** A time input field containing '00:00' and an unchecked 'Disabled' checkbox.
- Disconnect Time(HH:MM):** A time input field containing '00:00' and an unchecked 'Disabled' checkbox.

At the bottom right of the dialog, there are 'Add' and 'Cancel' buttons.

Item	Description
Routine Type	Use the drop-down menu to select how often you would like the profile to run: Once, Daily, Weekly and Monthly. If you select Weekly/ Monthly an additional drop-down menu appears to select the Week Day/Month Day on which the profile will run.
Start Date	Enter the date on which you want the schedule to begin running.
End Date	Enter the date on which you want the schedule to stop running.
Connect Time	Enter the time of day that you want the profile to connect.
Disconnect Time	Enter the time of day that you want the profile to disconnect.
Every	If you select a Monthly or Weekly Routine Type, the Every box appears allowing you to enter how often you want the schedule to run. For example, every 2, 3 or 4 weeks/months. If you want to run the schedule once a week or once a month, leave the default entry of 1.

- Click **Add** after you have configured the schedule.
- Click the **Permissions** tab to set the Profile's access rights:

Preset Settings | **Schedule** | Permissions | show: all | checked | unchecked

Users/Groups	Operation
▼ Users	<input type="checkbox"/>
user0002	<input type="checkbox"/>
user0003	<input type="checkbox"/>
user0004	<input type="checkbox"/>
▼ Groups	<input type="checkbox"/>

Item	Description
Users	You must assign access rights for the profile by selecting the Operation check box for the Users that you want to grant permission to allow the profile connections.
Groups	You must assign access rights for the profile by selecting the Operation check box for the Groups that you want to grant permission to allow the profile connections.

- After entering the information, click **Save**.

Video Wall

The *Video Wall* settings allow you to create a video wall by selecting a Transmitter for a set of User Stations that will display video content as one screen. A video wall is considered a connection from a Transmitter to multiple User Stations. Therefore, each source (Transmitter) on a video wall needs a separate *Video Wall* setting created in the Matrix Manager.

ID	Name	Description	Source Channel	Operation
5	Test1		KE6940T 35	Connect Disconnect
6	test2		KE6940T 35	Connect Disconnect
7	3x3		KE6940T 35	Connect Disconnect
8	8x8		KE6940T 35	Connect Disconnect
10	1			Connect Disconnect
11	2			Connect Disconnect
12	3			Connect Disconnect
13	4			Connect Disconnect
14	5			Connect Disconnect
15	6			Connect Disconnect
16	7			Connect Disconnect
17	8			Connect Disconnect
18	9			Connect Disconnect

The main page provides an overview of each *Video Wall*.

The meanings of the headings on the *Video Wall List* are straightforward.

- ♦ *ID* refers to the identification number assigned by the system.
- ♦ *Name* refers to the name entered on the Video Wall's *Settings* page.*
- ♦ *Description* refers to the description entered on the Video Wall's *Settings* page.
- ♦ *Source Channel* refers to the Transmitter selected for the User Stations.
- ♦ *Operation* allows you to click **Connect** to send the settings to start the Video Wall connections. Use **Disconnect** to remove the Video Wall settings from the Transmitter and User Station(s).
- ♦ Click **Add** to create a new Video Wall.
- ♦ Click **Modify** to change the selected Video Wall's settings.
- ♦ Click **Delete** to remove the selected Profile.

Note: Profiles and Video Walls can not share the same name.

Video Wall Example

The diagram below shows a 3x3 video wall setup with three Transmitters (video sources) connected to nine User Stations. In this scenario, three *Video Wall* settings (A, B, C) need to be added to the Matrix Manger.

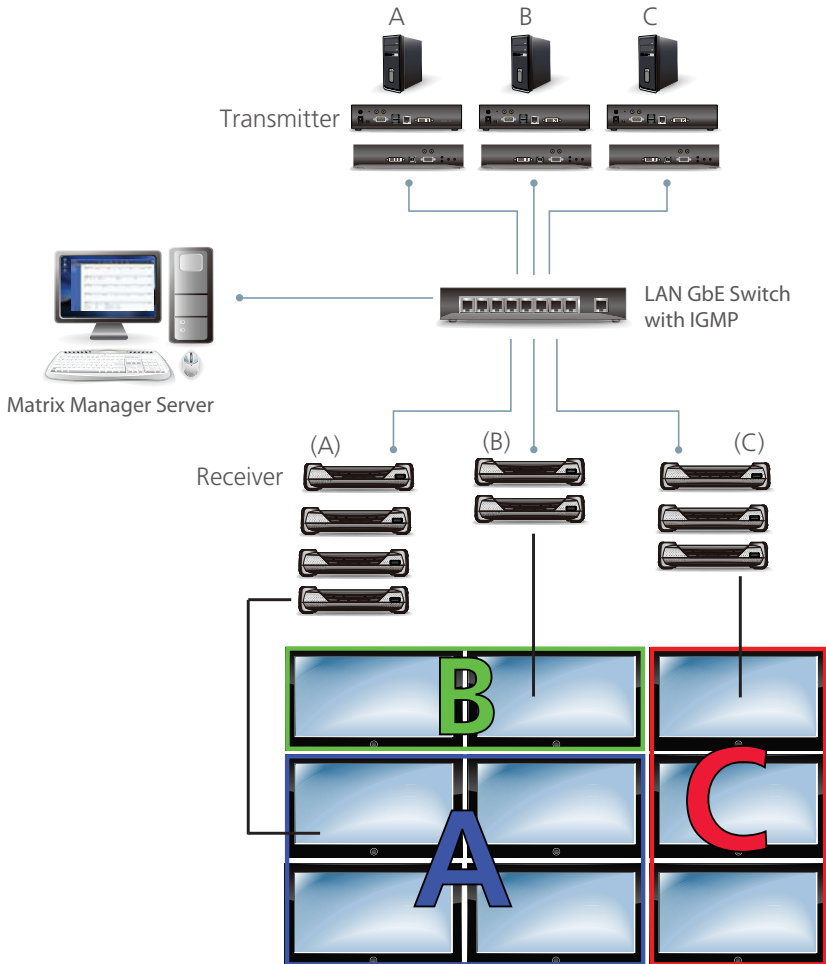

Adding a Video Wall

To add a Video Wall, do the following:

1. From the *Video Wall* main page, click **Add**:

ID	Name	Description	Source Channel	Operation
5	Test1		KE6940T 35	Connect Disconnect
6	test2		KE6940T 35	Connect Disconnect
7	3x3		KE6940T 35	Connect Disconnect
8	8x8		KE6940T 35	Connect Disconnect
10	1			Connect Disconnect

2. The *Video Wall Settings* tab appears allowing you to configure the settings:

Item	Description
Name/ Description	Enter a Name and Description for the Video Wall.

Item	Description
Access Mode	<p>This defines how the Source Channel (Transmitter) can be accessed by User Stations when multiple users attempt to access it.</p> <p>View Only: Users only have view access to the Source Channel video output.</p> <p>Share: Users simultaneously share control over the Source Channel. Input from the users is placed in a queue and executed chronologically.</p> <p>Occupy: The first user to access the Source Channel has control over it. However, additional users may view the Source Channel's video display. If the user who controls the Source Channel is inactive for longer than the time set in the Timeout box (see <i>Occupy Timeout</i>, page 85), control is transferred to the first user to move the mouse or strike the keyboard.</p>
Source Channel	<p>Click inside this box to bring up a list of Transmitters that can be select as the video source for the video wall, as shown below:</p> <div data-bbox="489 611 811 772" style="border: 1px solid gray; padding: 5px; margin: 10px auto; width: fit-content;"> <p>KE6900T 33(192.168.0.33) KE6940T 34(192.168.0.34) KE6940T 35(192.168.0.35) KE6940T 36(192.168.0.36)</p> </div> <p>Note: For KE6940T devices, only the DVI-I Input 1 port can be used as the source channel.</p>
Number of Displays	<p>Use the two slide bars to set the number of vertical and horizontal displays for the video wall.</p>
Bezel Dimension	<p>Sets the vertical and horizontal line size between each display in the video wall.</p>
Scale Mode	<p>Sets the scaling for the video output on the displays:</p> <ul style="list-style-type: none"> ◆ Stretch: fits the video on the entire display. ◆ Fit Width: fits the video to the width of the display. ◆ Fit Height: fits the video to the height of the display.
Video Wall Layout	<p>Click inside a box to bring up a list of User Stations that can be selected as the video output for that portion of the video wall.</p> <div data-bbox="500 1206 805 1378" style="border: 1px solid gray; padding: 5px; margin: 10px auto; width: fit-content;"> <p>KE6900R 23(192.168.0.23) KE6940R 24(192.168.0.24):1 KE6940R 24(192.168.0.24):2 KE6940R 25(192.168.0.25):1</p> </div>

Item	Description
Connect	Clicking Connect will send the Video Wall settings to the Transmitters and User Stations and will connect the devices accordingly.

- Click the **Schedule** tab if you want to schedule a time for the video wall to connect. A pop-up window appears:

Item	Description
Routine Type	Use the drop-down menu to select how often you would like the video wall to run: Once, Daily, Weekly and Monthly. If you select Weekly/Monthly an additional drop-down menu appears to select the Week Day/Month Day on which the profile will run.
Start Date	Enter the date on which you want the schedule to begin running.
End Date	Enter the date on which you want the schedule to stop running.
Connect Time	Enter the time of day that you want the video wall to connect.
Disconnect Time	Enter the time of day that you want the video wall to disconnect.
Every	If you select a Monthly or Weekly Routine Type, the Every box appears allowing you to enter how often you want the schedule to run. For example, every 2, 3 or 4 weeks/months. If you want to run the schedule once a week or once a month, leave the default entry of 1.

- Click **Add** after you have configured the schedule.
- Click the **Permissions** tab to set the Video Wall's access rights:

[Preset Settings](#)
[Schedule](#)
[Permissions](#)
show: checked | unchecked

Users/Groups	Operation
▼ Users	<input type="checkbox"/>
user0002	<input type="checkbox"/>
user0003	<input type="checkbox"/>
user0004	<input type="checkbox"/>
▼ Groups	<input type="checkbox"/>

Item	Description
Users	You must assign access rights for the Video Wall by selecting the Operation check box for the Users that you want to grant permission to allow the connections.
Groups	You must assign access rights for the Video Wall by selecting the Operation check box for the Groups that you want to grant permission to allow the connections.

- After entering the information, click **Save**.

This Page Intentionally Left Blank

Chapter 8

User Management

Overview

User Management has two menu bar items used to create **Accounts** and **Groups**. The User Management tab opens on the *Accounts* page, as shown here:

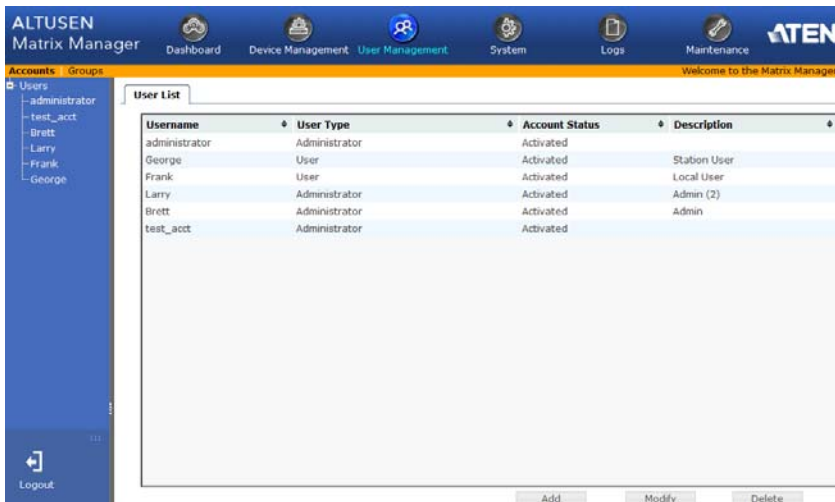

The page is organized into two main areas: the Sidebar at the left, and the large main panel at the right.

- ◆ Users and groups appear in the panel at the left of the page. The large panel at the right provides more detailed information at-a-glance for each.
 - ◆ There are menu bar entries for Accounts (Users) and Groups. Depending on the menu item selected, either Users or Groups are listed in the Sidebar.
- ◆ The sort order of the information displayed can be changed by clicking the main panel column headings.
- ◆ The buttons below the main panel are used to manage users and groups, as shown in the sections that follow.

Users

The Matrix Manager supports three types of user accounts, shown in the table below:

User Type	Role
Administrator	Access and management of the Matrix Manager, including configuration and setting up of devices. Manage Users, Groups, Channels, Profiles and Video Walls. Configure personal working environments.
Super User	Access User Station to connect Channels and Profiles they have been given permission for.
User	Access User Stations to connect to Channels they have been given permission for.

Adding Users

To add a user, do the following:

1. Select *Users* in the Sidebar.
2. Click **Add** at the bottom of the main page. The *User* tab opens:

User
Groups
Devices
Presets/Video Walls

General

Username: Local User

Password:

Confirm Password:

Description:

Role

Administrator Super User User

Status

Disable account

Enter the required information in the fields provided. A description of each is given in the table below:

Field	Description
Username	From 1 to16 characters are allowed depending on the Account Policy settings.

Field	Description
Local User	Check the Local User box if the account is for logging in to the Matrix Manager or a User Station (Receiver). Uncheck the Local User box if the account is authenticated with a 3rd party external source, such as RADIUS, LDAP/AD, or TACACS+. See <i>ANMS</i> , page 124 for details.
Password	From 0 to 16 characters are allowed depending on the Account Policy settings.
Confirm Password	To be sure there is no mistake in the password, you are asked to enter it again. The two entries must match.
Description	Additional information about the user that you may wish to include.
Role	There are three account categories: Administrator, Super User and User. <ul style="list-style-type: none"> ◆ The Administrators have full access to make changes within the Matrix Manager, which includes adding and removing Transmitters and Receivers, user accounts, preferences, and configuration settings. ◆ The Super Users have access to the OSD on User Stations and can connect Channels and Profiles. ◆ The Users can log in from User Stations to connect channels.
Status	Status allows you to control the user's account and access to the installation, as follows: <ul style="list-style-type: none"> ◆ <i>Disable Account</i> lets you suspend a user's account without actually deleting it, so that it can be easily reinstated in the future.

3. At this point you can assign the new user to a group by selecting the *Groups* tab – the Groups page is discussed on page 111. You can assign the user's Channels and Groups access rights by selecting the *Devices* tab – as discussed on page 115. You can assign the user's Profiles and Video Walls access rights by selecting the *Profiles/Video Walls* tab – as discussed on page 118.

Note: Optionally, you can skip this step now to add more users and create groups, and come back to it later.

4. When your selections have been made click **Save**.
5. When the *Operation Succeeded* message appears, click **OK**.
6. Click **Users** in the Sidebar to return to the main screen. The new user appears in the Sidebar list and in the main panel, as well.

- ◆ The Sidebar *Users* list can expand and collapse. If the list is expanded, click the minus symbol (–) next to the *Users* icon to collapse it; if it is collapsed there is a plus symbol (+) next to the icon. Click the plus symbol to expand it.
- ◆ The icon for administrators is orange; the icon for users is green.
- ◆ The large main panel shows the user’s name; the description that was given when the account was created; and whether the account is currently active or has been disabled.

Modifying User Accounts

To modify a user account, do the following:

1. In the Sidebar *User* list, click the user’s name
– or –

In the main panel, select the user’s name

2. Click **Modify**.
3. In the *User* page that comes up, make your changes, then click **Save**.

Note: The *User* page is discussed on page 106; the *Groups* page is discussed on page 111, the *Devices* page is discussed on page 115.

Deleting User Accounts

To delete a user account do the following:

1. In the main panel, select the user’s name.
2. Click **Delete**.
3. Click **OK**.

Groups

Groups allow administrators to easily and efficiently manage users and devices. Since device access rights apply to anyone who is a member of the group, administrators need only set them once for the group, instead of having to set them for each user individually. Multiple groups can be defined to allow some users access to specific devices, while restricting other users from accessing them.

Creating Groups

To create a group, do the following:

1. Select *Groups* on the menu bar.
2. Click **Add** at the bottom of the main panel. The Group notebook opens, with the *Group* tab selected:

3. Enter the required information in the appropriate fields. A description of each of the fields is given in the table below:

Field	Description
Group Name	A maximum of 16 characters is allowed.
Description	Additional information about the user that you may wish to include. A maximum of 63 characters is allowed.

4. At this point you can assign users to the group by selecting the *Members* tab – the Members page is discussed on page 113. You can also assign the group's Channels and Channel Groups access rights by selecting the *Devices* tab – the Devices page is discussed on page 115.
5. When your selections have been made click **Save**.
6. When the *Operation Succeeded* message appears, click **OK**.
7. Click *Group* in the Sidebar to return to the main screen. The new group appears in the Sidebar Group list and in the main panel.

- ◆ The Sidebar *Group* list can expand and collapse. If the list is expanded, click the minus symbol (–) next to the *Users* icon to collapse it; if it is collapsed there is a plus symbol (+) next to the icon. Click the plus symbol to expand it.
- ◆ The large main panel shows the group's name, and the description that was given when the group was created

Repeat the above procedure to add additional groups.

Note: You must perform Step 7 before attempting to add a new group, or else the new group you are creating will replace the group you just finished creating.

Modifying Groups

To modify a group, do the following:

1. In the Sidebar *Group* list, click the group's name
– or –
In the main panel, select the group's name.
2. Click **Modify**.
3. In the *Group* notebook that comes up, make your changes, then click **Save**.

Note: The *Group* page is discussed on page 109; the *Members* page is discussed on page 113, The *Devices* page is discussed on page 115.

Deleting Groups

To delete a group do the following:

1. In the Sidebar, click the *Groups* icon.
2. In the main panel, select the group's name.
3. Click **Delete**.
4. Click **OK**.

Users and Groups

There are two ways to manage users and groups: from the Users notebook; and from the Group notebook.

Note: Before you can assign users to groups, you must first create them. See *Adding Users*, page 106 for details.

Assigning Users to a Group From the User's Notebook

To assign a user to a group from the User's notebook, do the following:

1. In the Sidebar *User* list, click the user's name
– or –
In the main panel, select the user's name
2. Click **Modify**.
3. In the *User* notebook that comes up, select the *Groups* tab. A screen, similar to the one below, appears:

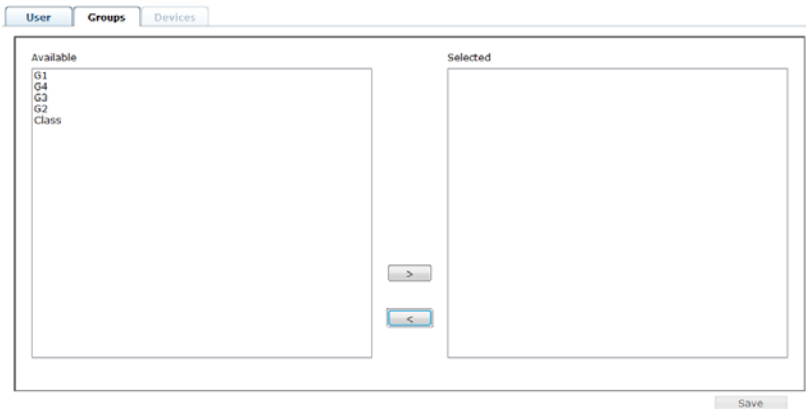

4. In the *Available* column, select the group that you want the user to be in.
5. Click the **Right Arrow** to put the group's name into the *Selected* column.
6. Repeat the above for any other groups that you want the user to be in.
7. Click **Save** when you are done.

Note: If a user has permissions in addition to the ones assigned to the group, the user keeps those permissions in addition to the group ones.

Removing Users From a Group From the User's Notebook

To remove a user from a group from the User's notebook, do the following:

1. In the Sidebar *User* list, click the user's name
– or –
In the main panel, select the user's name.
2. Click **Modify**.
3. In the *User* notebook that comes up, select the *Groups* tab. A screen, similar to the one below, appears:

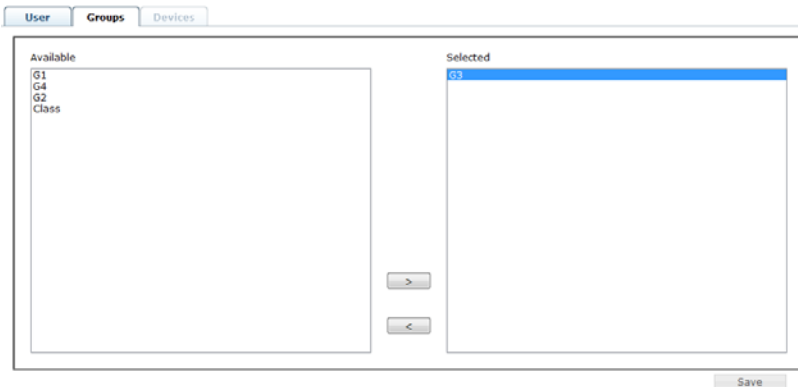

4. In the *Selected* column, select the group that you want to remove the user from.
5. Click the **Left Arrow** to remove the group's name from the *Selected* column. (It goes back into the *Available* column.)
6. Repeat the above for any other groups that you want to remove the user from.
7. Click **Save** when you are done.

Assigning Users to a Group From the Group's Notebook

To assign a user to a group from the Group notebook, do the following:

1. In the Sidebar *Group* list, click the group's name
 - or –
 In the main panel, select the group's name.
2. Click **Modify**.
3. In the *Group* notebook that comes up, select the *Members* tab. A screen, similar to the one below, appears:

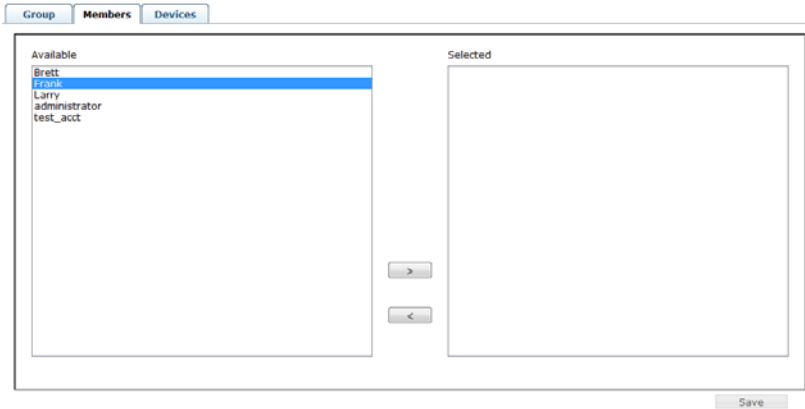

4. In the *Available* column, select the user that you want to be a member of the group.
5. Click the **Right Arrow** to put the user's name into the *Selected* column.
6. Repeat the above for any other users that you want to be members of the group.
7. Click **Save** when you are done.

Note: If a user has permissions in addition to the ones assigned to the group, the user keeps those permissions in addition to the group ones.

Removing Users From a Group From the Group's Notebook

To remove a user from a group from the Group's notebook, do the following:

1. In the Sidebar *Group* list, click the group's name
 – or –
 In the main panel, select the group's name.
2. Click **Modify**.
3. In the *Group* notebook that comes up, select the *Members* tab. A screen, similar to the one below, appears:

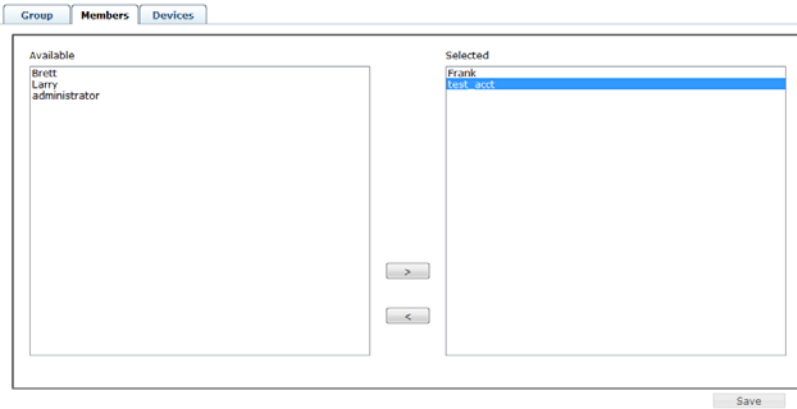

4. In the *Selected* column, select the user that you want to remove from the group.
5. Click the **Left Arrow** to remove the user's name from the *Selected* column. (It goes back into the *Available* column.)
6. Repeat the above for any other users that you want to remove from the group.
7. Click **Save** when you are done.

Device

You can assign Channel and Channel Group permissions from the *Devices* tab. For information on Channels and Channel Groups See *Channels*, page 88.

Assigning Device Permissions From the User's Notebook

To assign a device permissions to a user from the *User's* notebook, do the following:

- In the Sidebar *User* list, click the user's name
– or –
In the main panel, select the user's name.
- Click **Modify**.
- In the *User* notebook that comes up, select the *Devices* tab. A screen, similar to the one below, appears:

User	Groups	Devices	Profiles/Video Walls	
Channels/CGroups	View Only	Share	Occupy	Exclusive
▼ Channels	<input type="checkbox"/>	<input type="checkbox"/>	<input type="checkbox"/>	<input type="checkbox"/>
KE6900T 33	<input type="checkbox"/>	<input type="checkbox"/>	<input type="checkbox"/>	<input type="checkbox"/>
KE6940T 34	<input type="checkbox"/>	<input type="checkbox"/>	<input type="checkbox"/>	<input type="checkbox"/>
KE6940T 36	<input type="checkbox"/>	<input type="checkbox"/>	<input type="checkbox"/>	<input type="checkbox"/>
KE6940T 35	<input type="checkbox"/>	<input type="checkbox"/>	<input type="checkbox"/>	<input type="checkbox"/>
▼ Groups	<input type="checkbox"/>	<input type="checkbox"/>	<input type="checkbox"/>	<input type="checkbox"/>

- Make your permission settings for each device according to the information provided below:

Field	Description
Channels	Lists the Channels which you can assign access rights to for the user. (See <i>Channels</i> , page 88 for details)
Groups	Lists the Channel Groups which you can assign access rights to for the user. (See <i>Channel Groups</i> , page 92 for details)

Field	Description
Columns	<p>Check the boxes to apply access rights on the device for the user. This defines how the Channel can be accessed when multiple users access it.</p> <p>View Only: Users can only view the remote screen, and cannot perform operations on it.</p> <p>Share: Users simultaneously share control over the Channel. Input from the users is placed in a queue and executed chronologically.</p> <p>Occupy: The first user to access the Channel has control over the Channel. However, additional users may view the Channel's video display. If the user who controls the Channel is inactive for longer than the time set in the Timeout box, Channel control is transferred to the first user to move the mouse or strike the keyboard.</p> <p>Exclusive: The first user to access the Channel has exclusive control over the Channel. No other users can view the Channel. The Timeout function does not apply to Channels which have this setting.</p>

5. When you have finished making your choices, click **Save**.
6. In the confirmation popup that appears, click **OK**.

Assigning Device Permissions From the Groups' Notebook

To assign a device permissions to a Group of users, do the following:

1. In the Sidebar *Groups* list, click the group's name

– or –

In the main panel, select the group's name.

2. Click **Modify**.
3. In the *Groups* notebook that comes up, select the *Devices* tab.
4. The screen that comes up is the same one that appears in the User's notebook. The only difference is that whatever settings you make apply to all members of the group instead of just one individual member.

Make your device assignments according to the information described under *Assigning Device Permissions From the User's Notebook*, page 115.

Profiles/Video Walls

You can assign Profile and Video Wall permissions from the *Profiles/Video Walls* tab. For information on Profiles and Video Walls, see *Profiles*, page 94 or *Video Wall*, page 98.

Assigning Profile/Video Wall Permissions From the User's Notebook

To assign a Profile/Video Wall permission to a user from the *User's* notebook, do the following:

- In the Sidebar *User* list, click the user's name
– or –
In the main panel, select the user's name.
- Click **Modify**.
- In the *User* notebook that comes up, select the *Profile/Video Wall* tab. A screen, similar to the one below, appears:

User

Groups

Devices

Profiles/Video Walls

Profiles/Video Walls	Operation
▼ Profiles	<input type="checkbox"/>
r25	<input checked="" type="checkbox"/>
111111	<input checked="" type="checkbox"/>
22222	<input type="checkbox"/>
3333333	<input checked="" type="checkbox"/>
▼ Video Walls	<input type="checkbox"/>
Test1	<input checked="" type="checkbox"/>
test2	<input checked="" type="checkbox"/>
3x3	<input checked="" type="checkbox"/>
8x8	<input checked="" type="checkbox"/>
1	<input checked="" type="checkbox"/>

- Make your permission settings for each device according to the information provided below:

Field	Description
Profiles/ Video Walls	Lists the Profiles/Video Walls which you can assign access rights to for the user. (See <i>Channels</i> , page 88 for details)

Field	Description
Operation	Put a check in the box to grant permission for the user to connect to Profiles/Video Walls.

5. When you have finished making your choices, click **Save**.

Chapter 9 System

Overview

The *System* tab is used to configure the Matrix Manager's system settings and provides three menu bar items: **Global Settings**, **ANMS** and **Redundancy**. The System tab opens on the *Global Settings* page, as shown here:

The screenshot displays the 'Global Settings' page in the ALTUSEN Matrix Manager interface. The page is organized into several sections:

- General:** Matrix Manager Name: Matrix Manager; Description: (empty field).
- Network Ports:** HTTP Port: 8080; HTTPS Port: 8443; Device Port: 9110.
- Allowed Access Mode:** View Only (checked), Share (checked), Occupy (checked), Exclusive (checked).
- User Station Login Settings:** Login Required (unchecked); Non-Authorized User: administrator.
- Fast Switching:** Fast Switching: Disable.
- Global Device Properties:** A table with two columns: Properties and Sync.

Properties	Sync
Occupancy Timeout: 5 sec (1-240)	<input type="checkbox"/>
EDID Mode Selection: Default	<input type="checkbox"/>
Beeper: <input checked="" type="checkbox"/> Enable	<input type="checkbox"/>

The interface includes a top navigation bar with icons for Dashboard, Device Management, User Management, System, Logs, and Maintenance. A left sidebar contains a Logout button. A 'Save' button is located at the bottom right of the settings form.

Global Settings

The *Global Settings* page lets an administrator change the default settings used for the Matrix Manager:

General	
KE Manager Name:	Manager
Description:	
Network Ports	
HTTP Port:	8080
HTTPS Port:	8443
Device Port:	9110
Allowed Access Mode	
<input checked="" type="checkbox"/> View Only	<input type="checkbox"/> Share
<input type="checkbox"/> Occupy	<input type="checkbox"/> Exclusive
User Station Login Settings	
<input checked="" type="checkbox"/> Login Required	Non-Authorized User: Brett
Fast Switching	
Fast Switching:	Disable
Global Device Properties	
Properties	
Occupy Timeout:	5 sec (1-240)
EDID Mode Selection:	Default
Beeper:	<input checked="" type="checkbox"/> Enable
Sync	
	<input type="checkbox"/>
	<input type="checkbox"/>
	<input type="checkbox"/>
Matrix Manager Version: 1.4.131.025 (2015-07-29 09:09)	
Key serial number:	

Item	Description
General	Fill in a Name and Description for the Matrix Manager.
Network Ports	<p>Use this setting to specify the service ports used to access the Matrix Manager:</p> <ul style="list-style-type: none"> ◆ Device Port: This is the port number to configure on the Transmitter and User Station to access the Matrix Manager (see <i>Manager Address</i>, page 36 and <i>Manager Address</i>, page 32). The default is 9110. ◆ HTTP Port: This is the port number to use for a browser login. The default is 8080. ◆ HTTPS Port: This is the port number to use for a secure browser login. The default is 8443. <p>Example: To access the Matrix Manager on a computer with an IP address of 192.168.0.100, using a secure browser login (https), enter: https://192.168.0.100:8443</p>

Item	Description
Allowed Access Mode	<p>Select the default Access Mode for devices added to the Matrix Manager. This defines how the device can be accessed when multiple users log on.</p> <ul style="list-style-type: none"> ◆ View Only: Users can access the computer and view the screen, but cannot perform any operations on it. ◆ Exclusive: The first user to connect to the Transmitter has exclusive control over the computer. No other users can view the computer. The Timeout function does not apply to devices that have this setting. ◆ Occupy: The first user to connect to the Transmitter has control over the computer. However, additional users may view the computers video display. If the user who controls the computer is inactive for longer than the time set in the Timeout box, computer control is transferred to the next user to move the mouse or strike the keyboard. ◆ Share: Users simultaneously share control over the computer. Input from the users is placed in a queue and executed chronologically.
User Station Login Settings	<p>This will be the User Station's default setting when they are added to the Matrix Manager. You can change this setting from the User Station's <i>Properties</i>.</p> <ul style="list-style-type: none"> ◆ Check Login Required to prompt users for a username and password at the User Station OSD before being able to access the Connections Page (see <i>Connections Page</i>, page 41). If you uncheck this, you must set the Non-Authorized User. ◆ Non-Authorized User: If the <i>Login Required</i> box is <u>not</u> checked, select a user from the drop-down menu to use as the default profile to anonymously login to the User Station, in the background. <p>Note: WARNING! If Login Required isn't checked and an Anonymous User isn't selected, a system login error will occur in the User Station OSD.</p>
Fast Switching	<p>Allows you to select the default resolution to use that gives you the ability to switch faster between User Station and Transmitter connections. If the monitor you are using does not support fast switching the video may not display correctly when this setting is enabled.</p>

Item	Description
Global Device Properties	<p>These settings allow you to set the default properties used by all devices:</p> <ul style="list-style-type: none"> ◆ Occupy Timeout: Set the number of seconds for a user's session to be inactive before the access is released for use by another user, when using the Occupy Access Mode. This will be the default setting for Transmitters. ◆ EDID Mode Selection: Extended Display Identification Data (EDID) contains a display's basic information and is used by the source device to utilize the best resolution across different monitors. This will be the default setting for Transmitters. Select how you want the source device to acquire the display's EDID: <ul style="list-style-type: none"> ◆ Default: EDID is set to the ATEN default configuration. ◆ Auto: Checks the EDID of all connected displays and uses the best resolution for all displays. ◆ Manual: Manually set the EDID configuration from the User Station's OSD (see <i>Manual EDID</i>, page 42). ◆ Remix: Checks the EDID of all connected displays and the source device uses the best common resolution for all displays. ◆ Beeper: Check this box for the device to alert you with a sound when its first being accessed or when a configuration change is made. <p>Use the Sync check box for each option above to push the setting change to the devices after you click Save.</p>

ANMS

The *ANMS* (Advanced Network Management Settings) page is used to set up login authentication and authorization management from external sources. It is organized as a notebook with two tabs – each with a series of related panels, as described below.

Event Destination

The screenshot shows the 'Event Destination' configuration page. It features two tabs: 'Event Destination' (active) and 'Authentication & Authorization'. The 'Event Destination' tab contains two main sections: 'SMTP Settings' and 'Syslog Settings'.
 The 'SMTP Settings' section includes:
 - A checkbox labeled 'Enable report from the following SMTP Server'.
 - A 'Log Level' dropdown menu.
 - 'SMTP Server' and 'SMTP Port' text input fields, with '25' entered in the port field.
 - A checkbox labeled 'Server requires authentication'.
 - 'Account Name', 'Password', 'From', and 'To' text input fields.
 The 'Syslog Settings' section includes:
 - A checkbox labeled 'Enable'.
 - A 'Log Level' dropdown menu.
 - 'Server IP' and 'Service Port' text input fields, with '514' entered in the port field.
 A 'Save' button is located at the bottom right of the form area.

◆ SMTP Settings

To have the Matrix Manager email reports from the SMTP server to you, do the following:

1. Enable the *Enable report from the following SMTP Server*, select the *Log Level* (Information, Warning, or Error), and key in the *SMTP Server* IP address and *SMTP Port*.
2. If your server requires authentication, check the *Server requires authentication* checkbox, and key in the appropriate information for the *Account Name* and *Password* fields.
3. Key in the email address of where the report is being sent from in the *From* field.

- Note:**
1. Only one email address is allowed in the *From* field, and it cannot exceed 64 Bytes.
 2. 1 Byte = 1 English alphanumeric character.
-

4. Key in the email address (addresses) of where you want the SMTP reports sent to in the *To* field.
-

Note: If you are sending the report to more than one email address, separate the addresses with a semicolon. The total cannot exceed 256 Bytes.

5. Click **Save**.

◆ *Syslog Settings*

To record all the events that take place on the Matrix Manager and write them to a Syslog server, do the following:

1. Check **Enable**.
2. Use the drop-down menu to select the *Log Level* (Information, Warning, or Error).
3. Key in the *Server IP* address of the Syslog server.
4. Key in the *Service Port* number. The valid port range is 1-65535.
5. Click **Save**.

Authentication & Authorization

Event Destination
Authentication & Authorization

▼ RADIUS settings

Enable

Preferred RADIUS Server:

Preferred RADIUS Service Port:

Alternate RADIUS Server:

Alternate RADIUS Service Port:

Timeout: sec

Retries:

Shared Secret (at least 6 Characters):

▶ LDAP/AD settings

▶ TACACS+ settings

◆ RADIUS Settings

To allow authentication and authorization for the KE6900 / KE6940 through a RADIUS server, do the following:

1. Check **Enable**.
2. Fill in the IP addresses and service port of the *Preferred RADIUS Server* and *Alternate RADIUS Server*.
3. In the *Timeout* field, set the time in seconds that the Matrix Manager waits for a RADIUS server reply before it times out.
4. In the *Retries* field, set the number of allowed retries.
5. In the *Shared Secret* field, key in the character string that you want to use for authentication between the Matrix Manager and the RADIUS Server. A minimum of 6 characters is required.
6. On the RADIUS server, Users can be authenticated with any of the following methods:
 - ◆ Set the entry for the user as **su/xxxx**
Where *xxxx* represents the Username given to the user when the account was created on the Matrix Manager.
 - ◆ Use the same Username on both the RADIUS server and the Matrix Manager.

- ◆ Use the same Group name on both the RADIUS server and the Matrix Manager.
- ◆ Use the same Username/Group name on both the RADIUS server and the Matrix Manager.

In each case, the user's access rights are the ones assigned that were assigned when the User or Group was created on the Matrix Manager.

- ◆ *LDAP / AD Authentication and Authorization Settings:*

▼ LDAP/AD settings

Enable Enable SSL

Preferred LDAP Server:

Preferred LDAP Service Port:

Alternate LDAP Server:

Alternate LDAP Service Port:

Timeout: sec

Admin DN:

Admin Name:

Password:

Search DN:

To allow authentication and authorization for the Matrix Manager via LDAP / AD, refer to the information in the table, below:

Item	Action
Enable	Put a check in the Enable checkbox to allow LDAP / AD authentication and authorization.
Enable SSL	Put a check in the Enable checkbox to allow SSL connections.
LDAP Server IP and Port	Fill in the IP address and port number for the LDAP / AD server. ◆ You can use the IPv4 address, the IPv6 address or the domain name in the LDAP Server field. ◆ For LDAP, the default port number is 389.
Timeout	Set the time in seconds that the Matrix Manager waits for an LDAP / AD server reply before it times out.
Admin DN	Consult the LDAP / AD administrator to ascertain the appropriate entry for this field. For example, the entry might look like this: ou=kn4132,dc=aten,dc=com
Admin Name	Key in the LDAP administrator's username.
Password	Key in the LDAP administrator's password.
Search DN	Set the distinguished name of the search base. This is the domain name where the search starts for user names.

On the LDAP / AD server, Users can be authenticated with any of the following methods:

- ◆ With MS Active Directory schema.

Note: If this method is used, the LDAP schema for MS Active Directory must be extended. Without schema – Only the Usernames used on the Matrix Manager are matched to the names on the LDAP / AD server. User privileges are the same as the ones configured in the Matrix Manger.

- ◆ Without schema – Only the Usernames used on the Matrix Manager are matched to the names on the LDAP server. User privileges are the same as the ones configured in the Matrix Manager.
 - ◆ Without schema – Only Groups in AD are matched. User privileges are the ones configured for the groups he belongs to in the Matrix Manger.
 - ◆ Without schema – Usernames and Groups in AD are matched. User privileges are the ones configured for the User and the Groups in the Matrix Manger.
-
- ◆ *TACACS+ Settings:*

The image shows a configuration window titled "TACACS+ settings" with a dropdown arrow. Inside the window, there is a checkbox labeled "Enable" which is currently unchecked. Below the checkbox are six input fields, each with a label and a value:

- Preferred TACACS+ Server: [Empty text box]
- Preferred TACACS+ Service Port: 49
- Shared Secret 1(at least 6 Characters): [Empty text box]
- Alternate TACACS+ Server: [Empty text box]
- Alternate TACACS+ Service Port: 49
- Shared Secret 2(at least 6 Characters): [Empty text box]

- ◆ **Enable TACACS+** and enter the following information:
 - ◆ Preferred TACACS+ Server
 - ◆ Preferred TACACS+ Service Port
 - ◆ Shared Secret 1
 - ◆ Alternate TACACS+ Server
 - ◆ Alternate TACACS+ Service Port
 - ◆ Shared Secret 2

Redundancy

The *Redundancy* page sets up a second computer as backup in case the computer hosting the Matrix Manager goes off-line. If the Matrix Manager is off-line, the secondary computer will automatically take over operations, allowing all connections to continue without disruption – with only a brief period (30 seconds) when new connections can't be started. When the primary computer comes back online it retrieves the database with any changes from the secondary computer and re-takes all Matrix Manager operations.

To setup Redundancy, do the following:

1. Install the Matrix Manager on a second computer with the USB License key (see page 47).
2. Open the Matrix Manager and go to the *System* → *Redundancy* page.



3. Click **Modify**. The *Status* window appears:

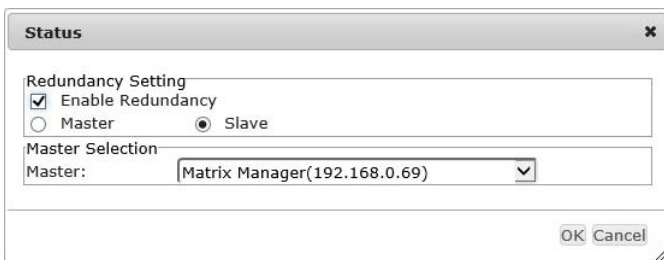

4. Check the **Enable Redundancy** box and select the **Slave** radio button.

5. Use the **Master** drop-down menu to select the primary computer's IP address.
6. Click **OK**.
7. This computer is now running in **Standby** mode, as identified in the orange status bar:



8. Remove the USB License key and plug it into the primary computer running the Matrix Manager software.
9. Open the Matrix Manager on the primary computer and go to the *System* → *Redundancy* page.

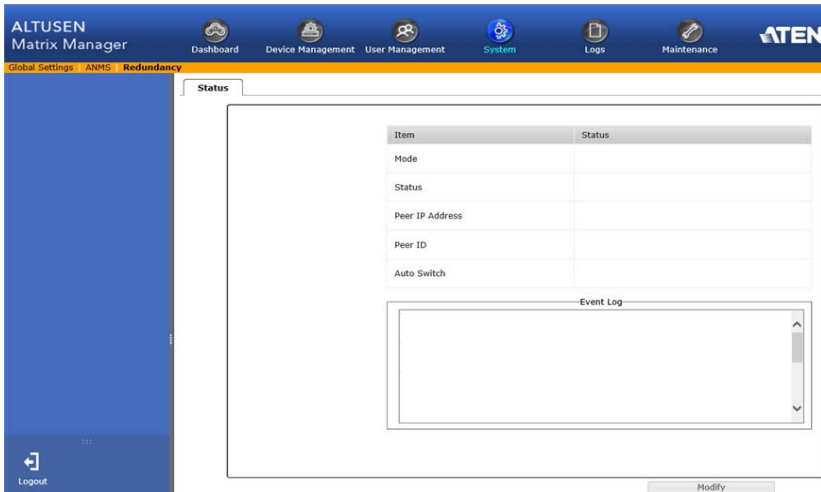

10. Click **Modify**. The *Status* window appears:

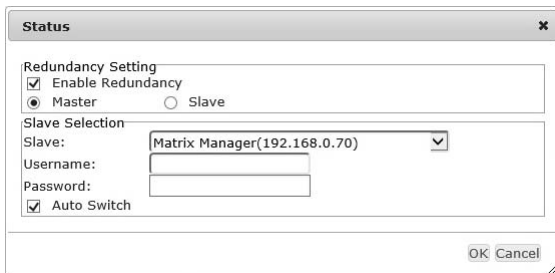

11. Check the **Enable Redundancy** box and select the **Master** radio button.
12. Use the **Slave** drop-down menu to select the secondary computer's IP address.
13. Enter the **Username** and **Password** of the secondary computer's local administrator account.
14. Check the **Auto Switch** box to automatically switch the Matrix Manager to the secondary computer when the primary computer is offline – and reverse the action when the primary computer is back online.
15. Click **OK**.
16. The **Redundancy** page provides information about the configuration.

Item	Status
Mode	Master
Status	Working
Peer IP Address	192.168.0.70
Peer ID	94DE80B750CD0000
Auto Switch	YES

Event Log	
Tue Nov 18 2014 11:35:49 GMT+0800 (台北標準時間)	KE Manager disconnected(ip=192.168.0.70).
Tue Nov 18 2014 10:14:58 GMT+0800 (台北標準時間)	KE Manager connected(ip=192.168.0.70).
Tue Nov 18 2014 09:22:20 GMT+0800 (台北標準時間)	KE Manager disconnected(ip=192.168.0.70).
Tue Nov 18 2014 09:22:20 GMT+0800 (台北標準時間)	KE Manager disconnected(ip=192.168.0.70).
Tue Nov 18 2014 08:01:27 GMT+0800 (台北標準時間)	KE Manager connected(ip=192.168.0.70).
Tue Nov 18 2014 07:08:51 GMT+0800 (台北標準時間)	KE Manager disconnected(ip=192.168.0.70).

Item	Action
Mode	Displays the role of the computer running the Matrix Manager software: Master (primary) or Slave (secondary).
Status	Displays Working for the computer currently managing the Matrix Manager database. Displays Standby when the computer is waiting as a backup and getting database updates from the primary computer running the Matrix Manager.
Peer IP Address	Displays the IP address of the computer configured to send (primary) or receive (secondary) the database updates for redundancy.

Item	Action
Peer ID	Displays the MAC address of the computer configured to send (primary) or receive (secondary) the database updates for redundancy.
Auto Switch	Displays the Auto Switch (Yes/No) status. (Master only).
Event Log	Displays the logs that provide information about the Matrix Manager's redundancy status.

Chapter 10

Logs

Overview

The Matrix Manager logs all the events that take place on it and stores them in a Log. The *Logs* tab opens on the **System Log** page, as shown here:

The screenshot shows the ALTUSEN Matrix Manager interface. The top navigation bar includes 'Dashboard', 'Device Management', 'User Management', 'System', 'Logs', and 'Maintenance'. The left sidebar has 'Devices', 'Users', 'Severity', and 'All' options. The main content area is titled 'System Log' and contains a table of log entries. The table has the following columns: Time, User, Severity, Device, and Log Information. The log entries include:

Time	User	Severity	Device	Log Information
03/28/2014 14:42:36		Information		Session created(Sessionid=*****bv6e) from ip
03/28/2014 14:42:36	administrator	Information		User login succeeded(username=administrator).
03/28/2014 14:40:27		Error		Cannot find the KE authentication key.
03/28/2014 14:31:43	administrator	Information		User login succeeded(username=administrator).
03/28/2014 14:31:43		Information		Session created(Sessionid=*****v9y0) from ip
03/28/2014 14:30:55		Information		Session terminated normally(Sessionid=*****Sztv)
03/28/2014 14:30:55	administrator	Information		User logout(username=administrator).
03/28/2014 14:30:55	administrator	Information		User logout(username=administrator).
03/28/2014 14:30:21		Information		Global settings has been changed.(code=0x180)
03/28/2014 14:30:06		Information		Global settings has been changed.(code=0x10000000)
03/28/2014 14:29:37		Information		Global settings has been changed.(code=0x10000000)
03/28/2014 14:29:23		Information		Global settings has been changed.(code=0x40)
03/28/2014 14:28:47	Brett	Information		New profile is added (id=000000000000003).
03/28/2014 14:28:23		Information		Session created(Sessionid=*****rwt1) from ip
03/28/2014 14:28:23	Brett	Information		User login succeeded(username=Brett).
03/28/2014 14:28:13	administrator	Information		User is modified (username=Brett).
03/28/2014 14:27:52	administrator	Warning		User login failed(username=administrator).
03/28/2014 14:27:48		Warning		User login failed(username=brett).
03/28/2014 13:58:27		Information		Session created(Sessionid=*****Sztv) from ip
03/28/2014 13:58:27	administrator	Information		User login succeeded(username=administrator).
03/28/2014 13:57:00		Error		Cannot find the KE authentication key.
03/28/2014 13:42:03		Information		Session created(Sessionid=*****wp7j) from ip
03/28/2014 13:42:03	administrator	Information		User login succeeded(username=administrator).
03/28/2014 13:13:34		Error		Cannot find the KE authentication key.
03/28/2014 12:30:19		Error		Cannot find the KE authentication key.

At the bottom of the log table, there are controls for page navigation: 1/80, 25 Per Page, and buttons for Configure, Export, and Filter.

System Log

The *System Log* page displays events that take place on the Matrix Manager and provides a breakdown of the time, user, severity, device, and log information, for a description of each event. You can change the sort order of the display by clicking on the column headings.

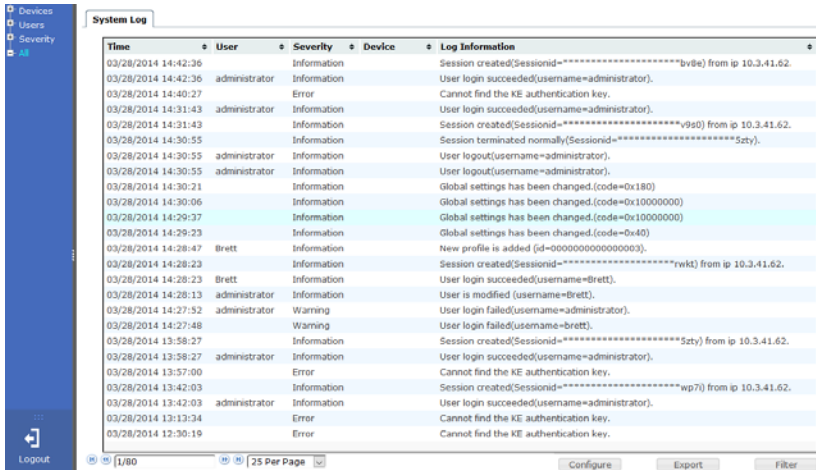

The screenshot shows the 'System Log' page. On the left is a sidebar menu with categories: Devices, Users, Severity, and All. The main area contains a table with columns: Time, User, Severity, Device, and Log Information. Below the table are navigation buttons: a left arrow, a right arrow, and a '25 Per Page' dropdown. At the bottom right are 'Configure', 'Export', and 'Filter' buttons.

Time	User	Severity	Device	Log Information
03/28/2014 14:42:36		Information		Session created(Sessionid=*****bv9e) from ip 10.3.41.62.
03/28/2014 14:42:36	administrator	Information		User login succeeded(username=administrator).
03/28/2014 14:40:27		Error		Cannot find the KE authentication key.
03/28/2014 14:31:43	administrator	Information		User login succeeded(username=administrator).
03/28/2014 14:31:43		Information		Session created(Sessionid=*****v9s0) from ip 10.3.41.62.
03/28/2014 14:30:55	administrator	Information		Session terminated normally(Sessionid=*****5zty).
03/28/2014 14:30:55	administrator	Information		User logout(username=administrator).
03/28/2014 14:30:55	administrator	Information		User logout(username=administrator).
03/28/2014 14:30:21		Information		Global settings has been changed.(code=0x180)
03/28/2014 14:30:06		Information		Global settings has been changed.(code=0x1000000)
03/28/2014 14:29:37		Information		Global settings has been changed.(code=0x1000000)
03/28/2014 14:29:23		Information		Global settings has been changed.(code=0x40)
03/28/2014 14:28:47	Brett	Information		New profile is added (id=0000000000000003).
03/28/2014 14:28:23	Brett	Information		Session created(Sessionid=*****rwt) from ip 10.3.41.62.
03/28/2014 14:28:23	Brett	Information		User login succeeded(username=Brett).
03/28/2014 14:28:13	administrator	Information		User is modified (username=Brett).
03/28/2014 14:27:52	administrator	Warning		User login failed(username=administrator).
03/28/2014 14:27:48		Warning		User login failed(username=brett).
03/28/2014 13:58:27		Information		Session created(Sessionid=*****5zty) from ip 10.3.41.62.
03/28/2014 13:58:27	administrator	Information		User login succeeded(username=administrator).
03/28/2014 13:57:00		Error		Cannot find the KE authentication key.
03/28/2014 13:42:03		Information		Session created(Sessionid=*****wp70) from ip 10.3.41.62.
03/28/2014 13:42:03	administrator	Information		User login succeeded(username=administrator).
03/28/2014 13:13:34		Error		Cannot find the KE authentication key.
03/28/2014 12:30:19		Error		Cannot find the KE authentication key.

- ◆ The first four buttons on the lower row navigate through the pages of the listed events. The left takes you to the first page; the right takes you to the last page; the middle buttons move you backward or forward one page.

Note: These buttons are only active when there is a relevant action they can perform. For example, when there is more than one page of information and you are on the first page, the “move forward” and “last page” buttons are active, but the “move backward” and “first page” buttons are not.

- ◆ Clicking the plus sign (+) beside a category in the sidebar menu expands the event headings into subcategories. Selecting a subcategory allows you to view only the logs that relate to that choice.
- ◆ Clicking **All** from the sidebar returns you to the default view to display all events.
- ◆ In general, a blank page, indicates that there were no log events recorded for that category.

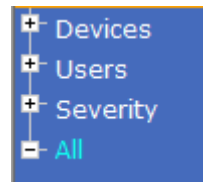

When the log file limit is reached, the oldest events get discarded as new events come in. The buttons at the bottom of the page are shown below and described in the tables below:



Button	Explanation
Navigation Buttons	The four buttons on the lower row (left side) navigate through the pages of the listed events. The left takes you to the first page; the right takes you to the last page; the middle buttons move you backward or forward one page.
Drop-Down Menu	Use this menu to select how many events you want to display per page. Available choices are 25, 50, and 100.

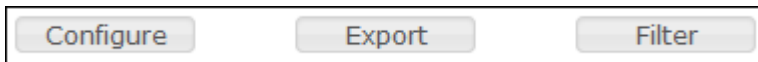

Button	Explanation
Configure	Clicking <i>Configure</i> opens a pop-up window that allows you to set how many days or the number of records to record before over-writing old log files. Use the radio button to select By period (days) or By records and enter the number you wish to use.
Export	Clicking <i>Export</i> lets you save the contents of the log to a file on your computer.
Filter	Clicking <i>Filter</i> allows you to search for particular events by date or by specific words or strings, as described in the next section.

Filter

Filter lets you narrow the log event display to ones that occurred at specific times; ones containing specific words or strings. When you access this function, the log filter dialog box appears at the bottom of the page:

A description of the filter items is given in the table, below:

Item	Description
Time	<p>This feature lets you filter for events that occurred at specific times, as follows:</p> <p>Today: Only the events for the current day are displayed.</p> <p>All: Displays all events.</p> <p>Range: Select a time frame of events. After selecting Range, click inside the From and To text box to bring up the calendar.</p> <ul style="list-style-type: none"> ◆ From: Filters for events from a specific date and time to the present. Click inside the <i>From</i> box to bring up a calendar. Set the date and time that you want the filtering to start from. All events from the Start date/time to the present are displayed. ◆ To: Filters for events from a specific date and time to a specific date and time. Click inside the <i>From</i> box to bring up a calendar. First select the From (described above).
Pattern	<p>Filters for a particular word or string. Key the word or string into the <i>Information</i> text box. Only events containing that word or string are displayed. Wildcards (? for single characters; * for multiple characters) and the keyword or are supported. E.g., h*ds would return hands and hoods; h?nd would return hand and hind, but not hard; h*ds or h*ks would return hands and hooks.</p>
Apply	Click to apply the filter choices.
Reset	Click this button to clear the entries in the dialog box and start with a clean slate.
Cancel	Click this button to exit the log filter function.

Chapter 11

Maintenance

Overview

The *Maintenance* tab has four menu bar options: **Backup/Restore**, **Firmware Upgrade**, **Certificates**, and **Preferences**. When you click the Maintenance tab, it opens on the *Backup/Restore* page, as shown here:

The screenshot shows the ALTUSEN Matrix Manager interface. The top navigation bar includes icons for Dashboard, Device Management, User Management, System, Logs, and Maintenance. The Maintenance tab is active, and the sub-menu shows Backup/Restore, Firmware Upgrade, Certificates, and Preferences. The main content area is titled 'Backup/Restore' and contains three sections: 'Backup' with a Password field and a Backup button; 'Restore' with a Filename field (with a Browse... button), a Password field, and a Restore button; and 'Export Device List' with an Export button. A Logout button is located in the bottom left corner of the interface.

- ◆ *Backup/Restore* allows administrators to backup system configuration settings to a file, and restore configuration settings from previously saved files.
- ◆ *Firmware Upgrade* allows administrators to upgrade firmware for network connected devices.
- ◆ *Certificates* allow for enhanced security, the *Private Certificate* section allows you to use your own private encryption key and signed certificate.
- ◆ *Preferences* allows the user that is logged in to set individual preferences for their browser sessions.

Backup / Restore

When you click the **Maintenance** tab Matrix Manager, the *Backup/Restore* page is displayed. The page is divided into two main sections: Backup, and Restore:

Backup/Restore

Backup

Password:

Restore

Filename

Password:

Export Device List

The operations to perform backup/restore procedures are described in the table below and in the section that follows:

Procedure	Operation
Backup	Backs up the Matrix Manager configuration – including User Station, Transmitter, Channel, and Profile configurations; user and group accounts, user profiles, logs, and system settings.
Restore	Deletes the current User Station, Transmitter, Channel, and Profile configurations; user and group accounts, user profiles, logs, and system settings.; then restores those settings to the values that exist in the previously saved backup file.
Export Device List	Clicking Export allows you to save a file with a complete list of the devices added to the Matrix Manger. The file contains the ID, Name, Description and IP Address of each Transmitter and User Station. An Existing column also lists if the device is available: Yes, it exists and is available, or No, it is off-line or has been removed.

Backup

To back up system configuration settings, do the following:

1. (Optional) In the *Backup* panel, provide a password for the backup file.

Note: Providing a password is a security feature – if you provide a password, you will need to give the same password in order to restore the configuration settings from this file.

2. Click **Backup**.
3. In the dialog box that comes up, Click **Save** to save the configuration file (*System.conf*) to a location on your hard disk.
4. Navigate to the directory where you want to save the file and click **Save**.

Restore

To restore system configuration settings, do the following:

1. In the *Restore* panel, click **Browse**.
2. Navigate to the directory where the backup file is located and select it.
3. When you return to the Backup/Restore page enter the password you set when the backup file was created.

Note: If you did not set a password for the file, leave the field blank.

4. Click **Restore**.
5. Click **OK** to confirm that you want to restore the configuration data.

When the Restore procedure is in process, a message stating that the Matrix Manager will restart will appear. After a short while the Matrix Manager closes and refreshes at the log in screen. When it comes back up the configuration settings that were restored from the backup file are in effect.

Firmware Upgrade

New firmware versions can be downloaded from our website as they become available. Check the website regularly, to find the latest upgrade packages.

Under Firmware Upgrade all KE6900/KE6940 devices that are discovered online are provided in a list allowing you to select which devices get upgraded.

To upgrade the firmware do the following:

1. Go to our website and download the firmware upgrade package appropriate to your KE6900 / KE6940 device.
2. Open your browser and log in to the Matrix Manager with an administrator's account.
3. Click the **Maintenance** tab; select **Firmware Upgrade** on the menu bar. A confirmation dialog box may appear:

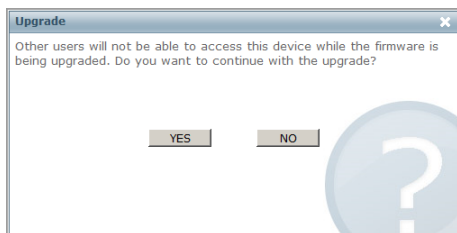

4. Click **Yes** to continue. After a short while, the *Firmware Upgrade* page comes up:

Firmware Upgrade

Select modules to upgrade

- User Station: KE6940R 26(192.168.0.26) V1.4.131
- User Station: KE6900R 23(192.168.0.23) V1.4.131
- User Station: KE6940R 25(192.168.0.25) V1.4.131
- User Station: KE6940R 24(192.168.0.24) V1.4.131
- Transmitter: KE6900T 33(192.168.0.33) V1.4.131
- Transmitter: KE6940T 34(192.168.0.34) V1.4.131
- Transmitter: KE6940T 36(192.168.0.36) V1.4.131
- Transmitter: KE6940T 35(192.168.0.35) V1.4.131

Check firmware version

Filename:

All the KE6900 / KE6940 devices that are capable of being upgraded are listed.

Note: Only online KE6900 / KE6940 devices show up in the list. Offline devices do not get upgraded.

5. Make sure there is a check in the checkbox in front of the modules you want to upgrade. Uncheck the modules that you do not want to upgrade.
6. Click **Browse**. Navigate to the directory where the firmware upgrade file is located and select it.
7. Enable or disable *Check Firmware Version*
 - ◆ If you enabled *Check Firmware Version* the current firmware level is compared with that of the upgrade file. If the current version is equal to or higher than the upgrade version, a popup message appears, to inform you of the situation and stops the upgrade procedure.
 - ◆ If you didn't enable *Check Main Firmware Version*, the upgrade file is installed without checking what its level is.
8. Click **Upgrade** to start the upgrade procedure. As the upgrade proceeds, progress information is shown on the screen. Once the upgrade completes successfully, the devices will reset.
9. Log in to the and check the firmware version to be sure it is the new one.

Firmware Upgrade Recovery

If the Upgrade Succeeded screen doesn't appear or the upgrade procedure is abnormally halted (due to computer crash, power failure, etc.), the device may become inoperable. If you find that the device does not work following a failed or interrupted upgrade, do the following

1. Power off the KE6900 / KE6940.
2. Press the **Reset** button, then power on the KE6900 / KE6940 while holding Reset.
3. Hold **Reset** for 7 seconds after the device is powered on.
4. The device will revert to a previous firmware version and recover from the failure.
5. Upgrade the firmware to the most current version available.

Certificates

This page provides information about the *Private Certificates*:

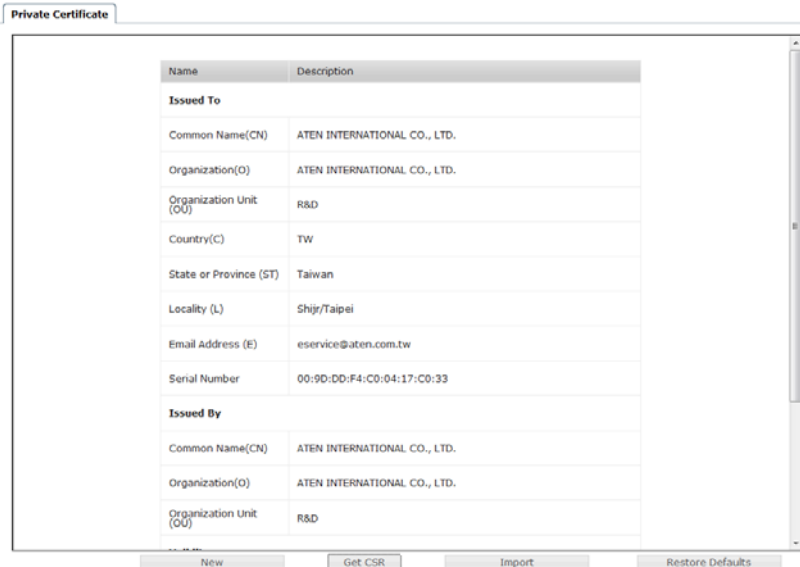

Private Certificate

When logging in over a secure (SSL) connection, a signed certificate is used to verify that the user is logging in to the intended site. For enhanced security, the *Private Certificate* section allows you to use your own private encryption key and signed certificate, rather than the default ATEN certificate.

There are two methods for establishing your private certificate: generating a self-signed certificate; and importing a third-party certificate authority (CA) signed certificate.

- ◆ **Generating a Self-Signed Certificate**

If you wish to create your own self-signed certificate, a free utility – openssl.exe – is available for download over the web. See *Self-Signed Private Certificates*, page 196 for details about using OpenSSL to generate your own private key and SSL certificate.

- ◆ **Obtaining a CA Signed SSL Server Certificate**

For the greatest security, we recommend using a third party certificate authority (CA) signed certificate. To obtain a third party signed certificate, go to a CA (Certificate Authority) website to apply for an SSL certificate.

After the CA sends you the certificate and private encryption key, save them to a convenient location on your computer.

- ◆ **Importing the Private Certificate**

To import the private certificate, do the following:

1. Click **Import** from the bottom of the Private Certificate page, shown here:



2. Click **Browse** to the right of *Certificate Filename*; and browse to where your certificate file is located; and select it.
3. Click **Import** to complete the procedure.

Note: Clicking **Restore Defaults** returns the device to using the default ATEN certificate.

Certificate Signing Request

The Certificate Signing Request (CSR) section provides an automated way of obtaining and installing a CA signed SSL server certificate.



To perform this operation do the following:

1. Click **New**. The following dialog box appears:

2. Fill in the form – with entries that are valid for your site – according to the example information in the following table:

Information	Example
Country (2 letter code)	TW

Information	Example
State or Province	Taiwan
Locality	Taipei
Organization	Your Company, Ltd.
Organization Unit	Tech Department
Common Name	mycompany.com Note: This must be the exact domain name of the site that you want the certificate to be valid for. If the site's domain name is <i>www.mycompany.com</i> , and you only specify <i>mycompany.com</i> , the certificate will not be valid.
Email Address	administrator@yourcompany.com

3. After filling in the form (all fields are required), click **Create**.
A self-signed certificate based on the information you just provided is now stored on the Matrix Manager.
4. Click Get CSR, and save the certificate file (*csr.cer*) to a convenient location on your computer.
This is the file that you give to the third party CA to apply for their signed SSL certificate.
5. After the CA sends you the certificate, save it to a convenient location on your computer. Click **Import** to locate the file; then click **Import** to store it on the Matrix Manager.

Note: When you upload the file, the Matrix Manager checks the file to make sure the specified information still matches. If it does, the file is accepted; if not, it is rejected.

If you want to remove the certificate (to replace it with a new one because of a domain name change, for example), simply click **Restore Defaults**.

Preferences

Users can set individual preferences for their browser sessions on the *Preferences* page. The *Preferences* page allows you to select options for the user that is currently logged in.

Language:	<input type="text" value="English"/>	<input type="checkbox"/>
Toolbar Hotkey:	<input type="text" value="[Ctrl][Ctrl]"/>	<input type="checkbox"/>
Logout Timeout:	<input type="text" value="30"/> min (0-180)	<input type="checkbox"/> Disabled
Screen Blanker:	<input type="text" value="0"/> min (0-30)	<input checked="" type="checkbox"/> Disabled
Welcome Message:	<input checked="" type="checkbox"/> Enable	<input type="checkbox"/> Username
<hr/>		
Old Password:	<input type="password"/>	
New Password:	<input type="password"/>	
Confirm Password:	<input type="password"/>	

Item	Description
Language	Click the drop-down menu to select the language you want to use during sessions for this user. Choices are: English, Chinese (Simplified), Chinese (Traditional), Japanese, Korean, Dutch, French, Spanish, Portuguese, and Russian.
Toolbar Hotkey	Select the hotkey combination to call the Tool Bar function for this user. The Tool Bar is used when accessing the computer from the Transmitter or Receiver side.
Logout Timeout	If there is no user input for the amount of time set with this function, the user is automatically logged out. A login is necessary before the Matrix Manager can be accessed again. The default is 30 minutes.
Screen Blanker	Set how many minutes the KE6900 / KE6940 waits when a session is idle before turning off the display.
Welcome Page	If you want the Welcome Message to appear on screen when the user logs in, select Enable . If you want the user's Screen Name to appear with the Welcome Message, check the Username check box.

Item	Description
Password	This section allows you to change the user's password: <ol style="list-style-type: none"><li data-bbox="336 197 849 225">1. Key in your old password in the Old password field.<li data-bbox="336 233 871 260">2. Key in your new password in the New password field.<li data-bbox="336 268 909 320">3. Key in your new password again in the Confirm password field.

When you have made your choices, Click **Save**.

To use the original system set preferences, click **Restore Defaults**.

Chapter 12

Firmware Upgrade Utility

The Windows-based Firmware Upgrade Utility (FWUpgrade.exe) provides a smooth, automated process for upgrading the firmware. The Utility comes as part of a Firmware Upgrade Package that is specific for each device. New firmware upgrade packages are posted on our web site as new firmware revisions become available. Check the web site regularly to find the latest packages and information relating to them:

<http://www.aten.com>

Preparation

1. From a computer that is not part of your installation go to our Internet support site and choose the model name that relates to your device KE6900 / KE6940 to get a list of available Firmware Upgrade Packages.
2. Choose the Firmware Upgrade Package you want to install (usually the most recent), and download it to your computer.
3. Be sure that the computer is connected to the same LAN segment as the KE6900 / KE6940 devices.

Starting the Upgrade

To upgrade your firmware:

1. Run the downloaded Firmware Upgrade Package file - either by double clicking the file icon, or by opening a command line and entering the full path to it. The Firmware Upgrade Utility Welcome screen appears:

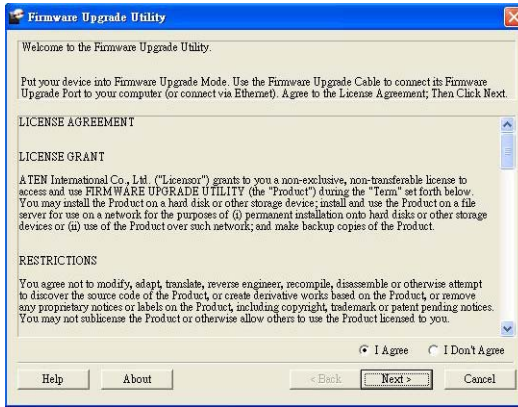

Note: The screens shown in this section are for reference only.

2. Read the License Agreement (enable the *I Agree* radio button).
3. Click **Next**. The Firmware Upgrade Utility main screen appears:

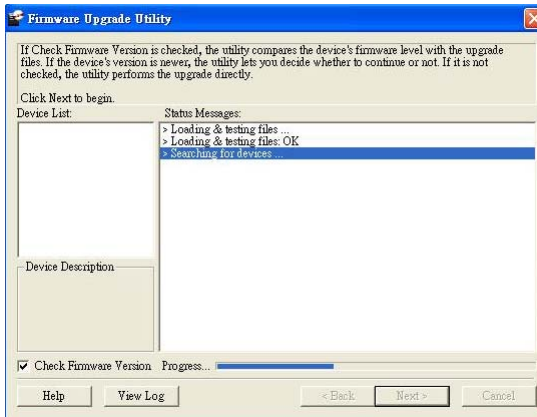

- The Utility inspects your installation. All the devices capable of being upgraded by the package are listed in the *Select Master Device* list.

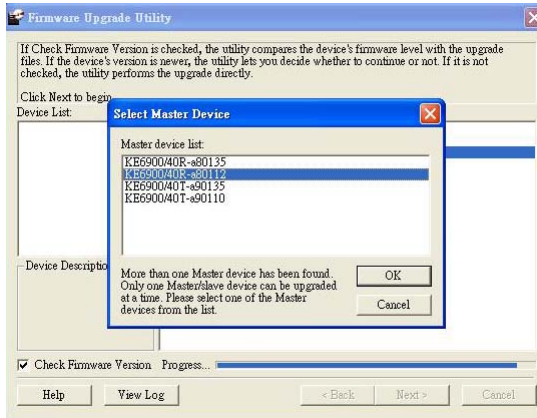

- After you have made your device selection, Click **OK** and then **Next** to begin the upgrade.

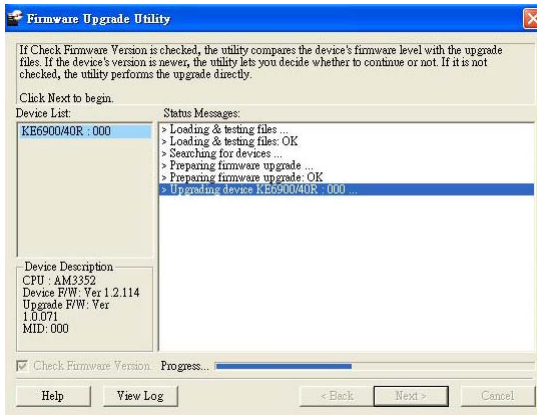

If you enabled *Check Firmware Version*, the Utility compares the device's firmware level with that of the upgrade files. If it finds that the device's version is higher than the upgrade version, it brings up a dialog box informing you of the situation and gives you the option to **Continue** or **Cancel**.

If you didn't enable *Check Firmware Version*, the Utility installs the upgrade files without checking whether they are a higher level, or not.

As the Upgrade proceeds status messages appear in the *Status Messages* panel, and the progress toward completion is shown on the *Progress* bar.

Firmware Upgrade Recovery

If the Upgrade Succeeded screen doesn't appear or the upgrade procedure is abnormally halted (due to computer crash, power failure, etc.), the device may become inoperable. If you find that the device does not work following a failed or interrupted upgrade, do the following

1. Power off the KE6900 / KE6940.
2. Press the **Reset** button, then power on the KE6900 / KE6940 while holding Reset.
3. Hold **Reset** for 7 seconds after the device is powered on.
4. The device will revert to a previous firmware version and recover from the failure.
5. Upgrade the firmware to the most current version available.

This Page Intentionally Left Blank

Chapter 13

RS-232 Commands

Serial Control Protocol Commands

The KE6900 / KE6940's built-in bi-directional RS-232 serial interface allows system control via User Stations through a high-end controller or PC.

Configuring the Serial Port

The controller's serial port should be configured the same as the User Station's default configuration, as shown below:

Baud Rate	9600
Data Bits	8
Parity	None
Stop Bits	1
Flow Control	None

The User Station's **Function Switch** should be set to *RS-232 Config* (see page 12). Before executing RS-232 commands across a network you must install the Matrix Manager on a computer and ensure that it is online.

Device/Profile Commands

When typing a device or profile into a command string, you can enter the name by: **IP address** (device only), **ID** or **@** with the list number in the command line interface. Use the list command to view device and profile information.

Verification

After sending a command, a verification message appears at the end of the command line. Use the echo command to identify a command by number:

- ♦ **Command OK** - the command is correct and performed successfully
- ♦ **Command incorrect** - the command has the wrong format and/or values.
- ♦ **Echo Command** - at the end of a command string, type: **e1234** – where 1234 can be any number. The verification message returns with the echo number.

Switch Port Command

The formula for Switch Port commands is as follows:

Command + Output + Num1 + Input + Num2 + Mode + Stream + Connect + [Enter]

1. For example, if you want to switch the User Station's connection to Transmitter (192.168.0.20), type the following:
sw i192.168.0.20 [Enter]
2. For example, if you want to disconnect the User Station from its Transmitter connections, type the following:
sw off [Enter]
3. For example, if you want to connect User Station (192.168.0.99) to Transmitter (192.168.0.79) with exclusive access to stream video and audio, type the following:
sw o192.168.0.99 i192.168.0.79 exclusive video audio on [Enter]
4. For example, to disconnect User Station (192.168.0.11) from the video stream and return it to the OSD menu, type the following:
sw o192.168.0.11 off [Enter]
5. For example, to disconnect User Station (192.168.0.09) from the video stream and logout the OSD, type the following:
sw o192.168.0.09 logout [Enter]
6. For example, to disconnect the User Station's USB stream, type the following:
sw usb off [Enter]
7. For example, to switch the User Station to the 5th Transmitter listed in the command line interface, type the following:
sw i@5 exclusive all on [Enter]
8. For example, to switch the User Station to the 7th Transmitter listed in the command line interface with echo command 4312, type the following:
sw i@7 exclusive all on e4312
9. For example, to switch User Station (192.168.0.12) to the 14th Transmitter listed in the command line interface with occupy access to stream video audio and USB, type the following:
sw o192.168.0.12 i@14 occupy video audio usb on [Enter]

The following tables show the possible values for the Switch Port commands:

Command	Description
sw	Switch port command

Output	Description
o	Output port command (RX)

Num1	Description
xx	Output port xx: User Station ID or IP address
@zz	List # zz: 1~99 To use the 4th User Station listed in the command line interface, type: o@4

Input	Description
i	Input command (TX)

Num2	Description
yy	Input port yy: Transmitter ID or IP address
@zz	List # zz: 1~99 To use the 8th Transmitter listed in the command line interface, type: i@8

Mode	Description
exclusive	Sets the Access Mode to exclusive.
share	Sets the Access Mode to share.
occupy	Sets the Access Mode to occupy.
viewonly	Sets the Access Mode to view only. If the mode is omitted, view only is used by default.

Stream	Description
video	Sets the video source stream
audio	Sets the audio source stream
serial	Sets the serial source stream

Stream	Description
usb	Sets the USB source stream
all	Sets all source streams

Connect	Description
on	Connect
off	Disconnect
logout	Logout OSD

The following table lists the available Switch Port commands:

Command	Output	Num1	Input	Num2	Mode	Stream	Connect	Description
sw	o	xx	i	yy	exclusive	video audio serial usb all	on	Switch output xx to input yy with exclusive access to source(s). xx: User Station ID yy: Transmitter ID
sw	o	xx	i	yy	share	video audio serial usb all	on	Switch output xx to input yy with share access to stream source(s). xx: User Station ID yy: Transmitter ID
sw	o	xx	i	yy	occupy	video audio serial usb all	on	Switch output xx to input yy with occupy access to stream source(s). xx: User Station ID yy: Transmitter ID
sw	o	xx	i	yy	viewonly	video audio serial usb all	on	Switch output xx to input yy with viewonly access to stream source(s). xx: User Station ID yy: Transmitter ID
sw	o	xx					off	Switch output xx, disconnect streams, return to OSD menu. xx: User Station ID
sw	o	xx					logout	Switch output xx, disconnect streams and logout from OSD menu. xx: User Station ID
sw						video audio serial usb all	off	Switch User Station stream(s) to disconnect.

Command	Output	Num1	Input	Num2	Mode	Stream	Connect	Description
sw							off	Switch User Station disconnect streams, return to OSD menu.
sw			i	@zz	exclusive share occupy viewonly	video audio serial usb all	on	Switch User Station to input @zz with [mode] access to stream source(s). zz: Transmitter # by order listed in the command line interface.
sw	o	xx	i	@zz	exclusive	video audio serial usb all	on	Switch output xx to input @zz with [mode] access to stream source(s). xx: User Station ID zz: Transmitter # by order listed in command line interface.

- Note:**
1. Each command string can be separated with a space.
 2. The **Mode** command string can be skipped and **view only** will be used by default.
 3. Skip the **Output** and **Num1** command strings to configure the local User Station.

Mute Command

The Mute command allows you to enable or disable the audio.

The formula for the Mute command is as follows:

Command + Output + Num1 + Control + [Enter]

1. For example, to turn mute off (audio on) for the User Station, type the following:

mute off [Enter]

2. For example, to turn mute on for User Station (192.168.0.11), type the following:

mute o192.168.0.11 on [Enter]

3. For example, to turn mute off for User Station (192.168.0.18), type the following:

mute o192.168.0.18 off [Enter]

The following tables show the possible values for the Mute commands:

Command	Description
mute	Mute command
Output	Description
o	Output port command
Num1	Description
xx	Output number xx: User Station ID or IP address
Control	Description
on	Mute on; audio disabled
off	Mute off; audio enabled (default)

The following table lists the available Mute commands:

Command	Output	Num1	Control	Description
mute	o	xx	on	Turn mute on for output xx xx: User Station ID
mute	o	xx	off	Turn mute off for output xx xx: User Station ID

Command	Output	Num1	Control	Description
mute			on	Turn mute on for User Station
mute			off	Turn mute off for User Station

- Note:**
1. Each command string can be separated with a space.
 2. The **Control** command string can be skipped and **off** will be used by default.
 3. Skip the **Output** and **Num1** command strings to configure the local User Station.
-

Profile Command

The Profile command allows you to connect profiles and video walls.

The formula for Profile commands is as follows:

Command + Profile + Num1 + Control + [Enter]

1. For example, to connect profile 8 and lock the OSD menu, type the following:
profile f8 [Enter]
2. For example, to connect profile 4 with access to the OSD menu, type the following:
profile f4 release [Enter]
3. For example, to disconnect profile 12 and return to the User Station to the OSD menu, type the following:
profile f12 back [Enter]

The following tables show the possible values for the Profile commands:

Command	Description
profile	Profile command

Profile	Description
f	Profile ID

Num1	Description
xx	Profile or Video Wall ID xx: 1-99

Control	Description
lock	Connect profile, lock access to OSD menu (default)
release	Connect profile, allow access to OSD menu
back	Disconnect profile, return User Station to OSD menu

The following table lists the available Profile commands:

Command	Profile	Num1	Control	Description
profile	f	xx	lock	Connect profile xx, lock OSD access xx:1~99
profile	f	xx	release	Connect profile xx, allow OSD access xx:1~99
profile	f	xx	back	Disconnect profile xx and return User Station to OSD menu xx: 1~99

Note: 1. Each command string can be separated with a space.

2. The **Control** command string can be skipped and **lock** will be used by default.

EDID Command

Extended Display Identification Data (EDID) is a data that contains a display's basic information and is used to communicate with the video source. The EDID commands allow you to change the EDID setting of a Transmitter.

The formula for the EDID command is as follows:

Command + Address + Number + Control + [Enter]

1. For example, if you want to configure device (192.168.0.3) to use the remix EDID mode, type the following:

edid a192.168.0.3 remix [Enter]

The following tables show the possible values for the EDID commands:

Command	Description
edid	EDID command
Address	Description
a	Address command
Number	Description
xx	Address number xx: User Station ID or IP address
Control	Description
auto	Checks the EDID of all connected displays and uses the best resolution for all displays.
remix	Checks the EDID of all connected displays and the source device uses the best common resolution for all displays.
default	Implements ATEN's default EDID. (default)
manual	Manually set the EDID configuration from the User Station's OSD (see <i>Manual EDID</i> , page 42).

The following table lists the available EDID commands:

Command	Address	Number	Control	Enter	Description
edid	a	xx	auto	[Enter]	Set EDID of address xx to auto. xx: Device ID or IP Address

Command	Address	Number	Control	Enter	Description
edid	a	xx	remix	[Enter]	Set EDID of address xx to remix. xx: Device ID or IP Address
edid	a	xx	default	[Enter]	Set EDID of address xx to default. xx: Device ID or IP Address
edid	a	xx	manual	[Enter]	Set EDID of address xx to manual. xx: Device ID or IP Address

Reset Command

The Reset command allows you to reset a device back to the default factory settings. Reset includes resetting the devices IP address.

The formula for the Reset command is as follows:

Command + Address + Number + [Enter]

1. For example, to reset device (192.168.0.95), type the following:
reset a192.168.0.95 [Enter]
2. For example, to reset the User Station, type the following:
reset [Enter]

The following tables show the possible values for the **Reset** command:

Command	Description
reset	Reset command

Address	Description
a	Address command

Number	Description
xx	Address number xx: User Station ID or IP address

The following table lists the available Reset commands:

Command	Address	Num	Enter	Description
reset	a	xx	[Enter]	Reset address xx back to the factory default settings xx: Device ID or IP Address
reset			[Enter]	Resets the User Station settings

Note: 1. Each command string can be separated with a space.

2. Skip the **Address** and **Number** command strings to reset the local User Station.
-

RS-232 Command

The RS-232 command allows you to set the RS-232 settings for a device.

The formula for the RS-232 command is as follows:

Command + Address + Number + Baud Rate + Parity + Data Bit + Stop Bit + Flow Control [Enter]

1. For example, to set device (192.168.0.33) with a baud rate of 38400, parity of none, data bit of 8, and stop bit of 1, type the following:

baud a192.168.0.33 38400 none 8 1 [Enter]

2. For example, to set the local device with a baud rate of 19200, type the following:

baud 19200 [Enter]

The following tables show the possible values for the RS-232 command:

Command	Description
baud	RS-232 command
Address	Description
a	Address command
Num1	Description
xx	Address number xx: Device ID or IP address
Baud Rate	Description
9600	Use 9600 baud rate
19200	Use 19200 baud rate
38400	Use 38400 baud rate
115200	Use 115200 baud rate
Parity	Description
None	Sets the parity to none
Even	Sets the parity to even
Odd	Sets the parity to odd
Data Bit	Description
5	Sets the data bit to 5
6	Sets the data bit to 6

Data Bit	Description
7	Sets the data bit to 7
8	Sets the data bit to 8
Stop Bit	Description
1	Sets the stop bit to 1
2	Sets the stop bit to 2
Flow Control	Description
None	Sets flow control to none
Hardware	Sets flow control to hardware
Xon	Sets flow control to Xon
Xoff	Sets flow control to Xoff

The following table lists the available Baud Rate commands:

Com mand	Address	Num 1	Baud Rate	Parity	Data Bit	Stop Bit	Flow Control	Description
baud	a	xx	9600	None Even Odd	5 6 7 8	1 2	None Hardware Xon/Xoff	Set address xx baud rate to 9600, with parity/ data bit/ stop bit / flow control setting
baud	a	xx	19200	None Even Odd	5 6 7 8	1 2	None Hardware Xon/Xoff	Set address xx baud rate to 19200, with parity/ data bit/ stop bit / flow control setting
baud	a	xx	38400	None Even Odd	5 6 7 8	1 2	None Hardware Xon/Xoff	Set address xx baud rate to 38400, with parity/ data bit/ stop bit / flow control setting
baud	a	xx	115200	None Even Odd	5 6 7 8	1 2	None Hardware Xon/Xoff	Set address xx baud rate to 115200, with parity/ data bit/ stop bit / flow control setting

Command	Address	Num 1	Baud Rate	Parity	Data Bit	Stop Bit	Flow Control	Description
baud			9600					Set local device baud rate to 9600
baud			19200					Set local device baud rate to 19200
baud			38400					Set local device baud rate to 38400
baud			115200					Set local device baud rate to 115200

- Note:**
1. Each command string can be separated with a space.
 2. The **Baud Rate** value is required but **Parity**, **Data Bit** and **Stop Bit** can be skipped and their setting will not change.
 3. Skip the **Address** and **Number** command strings to configure the local device settings.

OSD Command

To enable or disable the On-Screen Display (OSD) menu for a User Station, use the following command:

Command + Output + Number + Control + [Enter]

- For example, to enable the OSD for User Station 192.168.0.51, type:
osd o192.168.0.51 on [Enter]
- For example, to disable the OSD for the local User Station, type:
osd off [Enter]

The following tables show the possible values for the OSD command:

Command	Description
osd	OSD command

Output	Description
o	Output command

Number	Description
xx	Output number xx: User Station ID or IP address

Control	Description
on	Enable OSD functions
off	Disable OSD functions (default)

The following table lists the available OSD commands:

Command	Output	Number	Control	Enter	Description
osd	o	xx	on	[Enter]	Enable OSD functions for output xx xx: User Station ID or IP address
osd	o	xx	off	[Enter]	Disable OSD functions for output xx off (default) xx: User Station ID or IP address

Note: 1. Each command string can be separated with a space.

- Skip the **Output** and **Number** command strings to configure the local User Station.

List Command

The List command allows you to retrieve information about users, settings and connections.

The formula for the List command is as follows:

Command + Output + Input + Number + Control [Enter]

- For example, for a complete list of available channels, type the following:
list channel [Enter]
- For example, for a complete list of available profiles, type the following:
list profile [Enter]
- For example, to list all users logged into all OSD menus, type the following:
- list login [Enter]**
- For example, to list the user logged into the OSD on User Station (192.168.0.44), type the following:
list o192.168.0.44 login [Enter]
- For example, for a complete list of available connections, type the following:
list connection [Enter]
- For example, to list the current connections on Transmitter (192.168.0.88), type the following:
list i192.168.0.88 connection [Enter]

The following tables show the possible values for the List command:

Command	Description
list	List command
Output	Description
o	Output command
Input	Description
i	Input command
Number	Description
xx	Output or Input number xx: Device ID or IP address

Control	Description
channel	Lists information about the available channel(s)
profile	Lists information about the available profile and TV wall connections
rx	Lists information about the User Station
login	Lists information about users logged into to the OSD menu
connection	Lists information about a Transmitters current connections

The following table lists the available List commands:

Command	Output	Input	Number	Control	Description
list	o		xx	login	List output xx user logged into OSD.
list	o		xx	rx	List output xx User Station information
list		i	xx	connection	List input xx Transmitter information
list				channel	List all available channel information
list				profile	List all available profile information
list				rx	List information about all User Stations
list				login	List information about all OSD logins
list				connection	List information about all connections

Note: 1. Each command string can be separated with a space.

2. Skip the **Output** or **Input** and **Number** command strings to view the local User Station.

Read Command

The Read command allows you to retrieve the properties of a device.

The formula for the Read command is as follows:

Command + Output + Input + Number + Control [Enter]

1. For example, to read all of the local User Station's properties, type the following:
read all [Enter]
2. For example, to read all of User Station (192.168.0.19) device properties, type the following:
read o192.168.0.19 all [Enter]
3. For example, to read all of Transmitter (192.168.0.28) device properties, type the following:
read i192.168.0.28 all [Enter]
4. For example, to read the basic properties of User Station (192.168.0.61), type the following:
read o192.168.0.61 basic [Enter]
5. For example, to read the network properties of Transmitter (192.168.0.71), type the following:
read i192.168.0.71 network [Enter]

The following tables show the possible values for the Read command:

Command	Description
read	Read command
Output	Description
o	Output command
Input	Description
i	Input command
Number	Description
xx	Output or Input number xx: Device ID or IP address
Control	Description
all	Read all device properties

Control	Description
basic	Read basic properties
network	Read network properties
ipsettings	Read IP settings
rs232	Read RS232 properties
properties	Read connection properties
manager	Read Matrix Manager properties
streams	Read enable media properties
tx	Read source stream IP properties (User Station)
usbmode	Read USB mode properties (User Station)
multicast	Read multicast properties (Transmitter)
videoqtyadvanced	Read advanced video properties (Transmitter)
ossettings	Read OS properties (Transmitter)

The following table lists the available Read commands:

Command	Output	Input	Number	Control	Description
read	o	i	xx	all	Read output or input xx all device properties xx: Device ID or IP address
read	o	i	xx	basic	Read output or input xx basic properties xx: Device ID or IP address
read	o	i	xx	network	Read output or input xx network properties xx: Device ID or IP address
read	o	i	xx	ipsettings	Read output or input xx IP address properties xx: Device ID or IP address

Command	Output	Input	Number	Control	Description
read	o	i	xx	rs232	Read output or input xx RS-232 properties xx: Device ID or IP address
read	o	i	xx	properties	Read output or input xx connection properties xx: Device ID or IP address
read	o	i	xx	manager	Read output or input xx Matrix Manager IP and port properties xx: Device ID or IP address
read	o	i	xx	streams	Read output or input xx enable media properties xx: Device ID or IP address
read	o		xx	tx	Read output xx source stream IP address properties xx: User Station ID or IP address
read	o		xx	usbmode	Read output xx USB mode properties xx: User Station ID or IP address
read	i		xx	multicast	Read input xx multicast properties xx: Transmitter ID or IP address
read	i		xx	videotyadvanced	Read input xx advanced video properties xx: Transmitter ID or IP address
read	i		xx	ossettings	Read input xx OS properties xx: Transmitter ID or IP address
read				all	Read all properties of local User Station

Command	Output	Input	Number	Control	Description
read				basic network ipsettings rs232 properties manager streams tx usbmode	Read [control] properties of local User Station.

- Note:** 1. Each command string can be separated with a space.
2. Skip the **Output** or **Input** and **Number** command strings to read the local User Station properties.
-

Set Command

The Set command allows you to configure the properties of a device. Some settings require that both the device and Matrix Manger are online or the command will fail.

The formula for the Set command is as follows:

Command + Output + Input + Number + Control + Value + [Enter]

- For example, to set the name of the local User Station to KE6940TX1, type the following:
set Name=KE6940TX1 [Enter]
- For example, to set the description of Transmitter (192.168.0.33) to KE Room B, type the following:
set o192.168.0.19 Description=KE Room B [Enter]
- For example, to set the DHCP settings of Transmitter (192.168.0.28) to static, type the following:
set i192.168.0.28 dhcpFlag=STATIC [Enter]
- For example, to set the IP settings of the local User Station to 192.168.0.2, type the following:
set ipAddr=192.168.0.2 [Enter]
- For example, to set the Transmitter Video IP setting to 192.168.0.44 for User Station (192.168.0.56), type the following:
set o192.168.0.56 TxVideoIP=192.168.0.44 [Enter]

The following tables show the possible values for the Set command:

Command	Description
set	Set command
Output	Description
o	Output command
Input	Description
i	Input command
Number	Description
xx	Output or Input number xx: Device ID or IP address

Control	Description
Name	Sets the device name
Description	Sets the device description
ipInstallerFlag	Sets the IP installer option
dhcpFlag	Sets the DHCP setting
ipAddr	Sets the IP address
netmask	Sets the subnet mask
gw	Sets the default gateway
modeFlag	Sets the device mode
BaudRate	Sets the baud rate setting
Parity	Sets the parity setting
DataBit	Sets the data bit setting
StopBit	Sets the stop bit setting
FlowCtrl	Sets the flow control setting
TxVideoIP	Sets the Transmitter video IP setting
TxAudioIP	Sets the Transmitter audio IP setting
TxUSBIP	Sets the Transmitter USB IP setting
TxRSIP	Sets the Transmitter RS-232 IP setting
VideoEnFlag	Sets the (enable media) video source stream
AudioEnFlag	Sets the (enable media) audio source stream
USBEnFlag	Sets the (enable media) USB source stream
RSEnFlag	Sets the (enable media) RS232 source stream
ManagerIP	Sets the Matrix Manager IP
ManagerPort	Sets the Matrix Manager port
Beeper	Sets the beeper
RxVM	Sets the USB mode setting
USBSecure	Sets the USB encryption
PortOS	Sets the port OS setting
OSLanguage	Sets the OS language
videoMCastEn	Sets the enable multicast video setting
audioMCastEn	Sets the enable multicast audio setting

Control	Description
Edid	Sets the EDID mode selection setting
VideoType	Sets the video type setting
ColorDepth	Sets the color depth setting
BandwidthLimit	Sets the bandwidth limit setting
VideoQty	Sets the video quality setting
BGRRefresh	Sets the background refresh setting
Beeper	Sets the beeper setting
OccupyTimeout	Sets the occupy timeout setting
Resolution	Sets the resolution setting

Value	Description
=yy	Set value to yy yy: Enter a value that corresponds to the control being used

The following table lists the available Set commands:

Command	Output	Input	Number	Control	Value	Description
Set	o	i	xx	Name	yy	Set output or input xx Name to yy xx: Device ID or IP address yy: Name value
Set	o	i	xx	Description	yy	Set output or input xx Description to yy xx: Device ID or IP address yy: Description value
Set	o	i	xx	ipInstallerFlag	yy	Set output or input xx ipInstallerFlag to yy xx: Device ID or IP address yy: enable, viewonly, disable

Comm and	Output	Input	Number	Control	Value	Description
Set	o	i	xx	dhcpFlag	yy	Set output or input xx dhcpFlag to yy xx: Device ID or IP address yy: dhcp, static
Set	o	i	xx	ipAddr	yy	Set output or input xx ipAddr to yy xx: Device ID or IP address yy: IP address value
Set	o	i	xx	netmask	yy	Set output or input xx netmask to yy xx: Device ID or IP address yy: Subnet mask value
Set	o	i	xx	gw	yy	Set output or input xx gw to yy xx: Device ID or IP address yy: Default gateway value
Set	o	i	xx	modeFlag	yy	Set output or input xx modeFlag to yy xx: Device ID or IP address yy: extender, matrix
Set	o	i	xx	BaudRate	yy	Set output or input xx BaudRate to yy xx: Device ID or IP address yy: 9600, 19200, 38400, 115200
Set	o	i	xx	Parity	yy	Set output or input xx Parity to yy xx: Device ID or IP address yy: none, even, odd
Set	o	i	xx	DataBit	yy	Set output or input xx DataBit to yy xx: Device ID or IP address yy: 5, 6, 7, 8

Command	Output	Input	Number	Control	Value	Description
Set	o	i	xx	StopBit	yy	Set output or input xx StopBit to yy xx: Device ID or IP address yy: 1, 1.5, 2
Set	o	i	xx	FlowCtrl	yy	Set output or input xx FlowCtrl to yy xx: Device ID or IP address yy: none, hardware, Xon, Xoff
Set	o	i	xx	TxVideoIP	yy	Set output xx TxVideoIP to yy xx: Device ID or IP address yy: IP address value
Set	o		xx	TxAudioIP	yy	Set output xx TxAudioIP to yy xx: Device ID or IP address yy: IP address value
Set	o		xx	TxUSBIP	yy	Set output xx TxUSBIP to yy xx: Device ID or IP address yy: IP address value
Set	o		xx	TxRSIP	yy	Set output xx TxRSIP to yy xx: Device ID or IP address yy: IP address value
Set	o	i	xx	VideoEnFlag	yy	Set output or input xx VideoEnFlag to yy xx: Device ID or IP address yy: enable, disable
Set	o	i	xx	AudioEnFlag	yy	Set output or input xx AudioEnFlag to yy xx: Device ID or IP address yy: enable, disable

Comm and	Output	Input	Number	Control	Value	Description
Set	o	i	xx	USBEnFlag	yy	Set output or input xx USBEnFlag to yy xx: Device ID or IP address yy: enable, disable
Set	o	i	xx	RSEnFlag	yy	Set output or input xx RSEnFlag to yy xx: Device ID or IP address yy: enable, disable
Set	o	i	xx	ManagerIP	yy	Set output or input xx ManagerIP to yy xx: Device ID or IP address yy: Matrix Manager IP address
Set	o	i	xx	ManagerPort	yy	Set output or input xx ManagerPort to yy xx: Device ID or IP address yy: Matrix Manager port
Set	o	i	xx	Beeper	yy	Set output or input xx Beeper to yy xx: Device ID or IP address yy: enable, disable
Set	o		xx	RxVM	yy	Set output xx RxVM to yy xx: Device ID or IP address yy: vm, vusb
Set	o		xx	USBSecure	yy	Set output xx USBSecure to yy xx: Device ID or IP address yy: on, off
Set		i	xx	PortOS	yy	Set input xx PortOS to yy xx: Device ID or IP address yy: win, mac, sun, other

Comm and	Output	Input	Number	Control	Value	Description
Set		i	xx	OSLanguage	yy	Set input xx OSLanguage to yy xx: Device ID or IP address yy: english, japanese, french, german, spanish, korean, chinese(traditional), english(uk), swedish, arabic, belgian, canadian-bilingual, french(canada), czech, danish, finnish, greek, hebrew, hungarian, international(iso), italian, latin american, dutch, norwegian, persian(farsi), polish, portuguese, russian, slovak, french (switzerland), german (switzerland), switzerland, reserved, turkish-q, reserved, serbo-croatian
Set		i	xx	videoMCastEn	yy	Set input xx videoMCastEn to yy xx: Device ID or IP address yy: enable, disable
Set		i	xx	audioMCastEn	yy	Set input xx audioMCastEn to yy xx: Device ID or IP address yy: enable, disable
Set		i	xx	Edid	yy	Set input xx Edid to yy xx: Device ID or IP address yy: default, auto, manual, remix
Set		i	xx	VideoType	yy	Set input xx VideoType to yy xx: Device ID or IP address yy: dvi-d, dvi-a

Command	Output	Input	Number	Control	Value	Description
Set		i	xx	ColorDepth	yy	Set input xx ColorDepth to yy xx: Device ID or IP address yy: 8, 16, 24
Set		i	xx	BandwidthLimit	yy	Set input xx BandwidthLimit to yy xx: Device ID or IP address yy: unlimited, 10, 20, 50, 100, 200, 500
Set		i	xx	VideoQty	yy	Set input xx VideoQty to yy xx: Device ID or IP address yy: 1, 2, 3, 4, 5
Set		i	xx	BGRefresh	yy	Set input xx BGRefresh to yy xx: Device ID or IP address yy: off, 16, 32, 64, 128, 256
Set		i	xx	OccupyTimeout	yy	Set input xx OccupyTimeout to yy xx: Device ID or IP address yy: 1~240
Set		i	xx	Resolution	yy	Set input xx Resolution to yy xx: Device ID or IP address yy: 1920x1200, 1920x1080, 1680x1050, 1600x1200, 1600x900, 1440x900, 1400x1050, 1366x768, 1280x1024, 1280x960, 1280x720, 1152x864, 1024x768, 800x600, 720x400, 640x480

Safety Instructions

General

- ◆ This product is for indoor use only.
- ◆ Read all of these instructions. Save them for future reference.
- ◆ Follow all warnings and instructions marked on the device.
- ◆ Do not place the device on any unstable surface (cart, stand, table, etc.). If the device falls, serious damage will result.
- ◆ Do not use the device near water.
- ◆ Do not place the device near, or over, radiators or heat registers.
- ◆ The device cabinet is provided with slots and openings to allow for adequate ventilation. To ensure reliable operation, and to protect against overheating, these openings must never be blocked or covered.
- ◆ The device should never be placed on a soft surface (bed, sofa, rug, etc.) as this will block its ventilation openings. Likewise, the device should not be placed in a built in enclosure unless adequate ventilation has been provided.
- ◆ Never spill liquid of any kind on the device.
- ◆ Unplug the device from the wall outlet before cleaning. Do not use liquid or aerosol cleaners. Use a damp cloth for cleaning.
- ◆ The device should be operated from the type of power source indicated on the marking label. If you are not sure of the type of power available, consult your dealer or local power company.
- ◆ The device is designed for IT power distribution systems with 230V phase-to-phase voltage.
- ◆ To prevent damage to your installation it is important that all devices are properly grounded.
- ◆ The device is equipped with a 3-wire grounding type plug. This is a safety feature. If you are unable to insert the plug into the outlet, contact your electrician to replace your obsolete outlet. Do not attempt to defeat the purpose of the grounding-type plug. Always follow your local/national wiring codes.
- ◆ Do not allow anything to rest on the power cord or cables. Route the power cord and cables so that they cannot be stepped on or tripped over.

- ◆ If an extension cord is used with this device make sure that the total of the ampere ratings of all products used on this cord does not exceed the extension cord ampere rating. Make sure that the total of all products plugged into the wall outlet does not exceed 15 amperes.
- ◆ To help protect your system from sudden, transient increases and decreases in electrical power, use a surge suppressor, line conditioner, or uninterruptible power supply (UPS).
- ◆ Position system cables and power cables carefully; Be sure that nothing rests on any cables.
- ◆ Never push objects of any kind into or through cabinet slots. They may touch dangerous voltage points or short out parts resulting in a risk of fire or electrical shock.
- ◆ Do not attempt to service the device yourself. Refer all servicing to qualified service personnel.
- ◆ If the following conditions occur, unplug the device from the wall outlet and bring it to qualified service personnel for repair.
 - ◆ The power cord or plug has become damaged or frayed.
 - ◆ Liquid has been spilled into the device.
 - ◆ The device has been exposed to rain or water.
 - ◆ The device has been dropped, or the cabinet has been damaged.
 - ◆ The device exhibits a distinct change in performance, indicating a need for service.
 - ◆ The device does not operate normally when the operating instructions are followed.
- ◆ Only adjust those controls that are covered in the operating instructions. Improper adjustment of other controls may result in damage that will require extensive work by a qualified technician to repair.
- ◆ Do not connect the RJ-11 connector marked “UPGRADE” to a public telecommunication network.

Rack Mounting

- ◆ Before working on the rack, make sure that the stabilizers are secured to the rack, extended to the floor, and that the full weight of the rack rests on the floor. Install front and side stabilizers on a single rack or front stabilizers for joined multiple racks before working on the rack.
- ◆ Always load the rack from the bottom up, and load the heaviest item in the rack first.
- ◆ Make sure that the rack is level and stable before extending a device from the rack.
- ◆ Use caution when pressing the device rail release latches and sliding a device into or out of a rack; the slide rails can pinch your fingers.
- ◆ After a device is inserted into the rack, carefully extend the rail into a locking position, and then slide the device into the rack.
- ◆ Do not overload the AC supply branch circuit that provides power to the rack. The total rack load should not exceed 80 percent of the branch circuit rating.
- ◆ Make sure that all equipment used on the rack – including power strips and other electrical connectors – is properly grounded.
- ◆ Ensure that proper airflow is provided to devices in the rack.
- ◆ Ensure that the operating ambient temperature of the rack environment does not exceed the maximum ambient temperature specified for the equipment by the manufacturer.
- ◆ Do not step on or stand on any device when servicing other devices in a rack.

Technical Support

International

- ◆ For online technical support – including troubleshooting, documentation, and software updates: **<http://support.aten.com>**
- ◆ For telephone support, See *Telephone Support*, page iv:

North America

Email Support		support@aten-usa.com
Online Technical Support	Troubleshooting Documentation Software Updates	http://www.aten-usa.com/support
Telephone Support		1-888-999-ATEN ext 4988

When you contact us, please have the following information ready beforehand:

- ◆ Product model number, serial number, and date of purchase.
- ◆ Your computer configuration, including operating system, revision level, expansion cards, and software.
- ◆ Any error messages displayed at the time the error occurred.
- ◆ The sequence of operations that led up to the error.
- ◆ Any other information you feel may be of help.

Specifications

Function		KE6900T	KE6940T	
Connectors	Console Ports	Keyboard	1 x USB Type A Female (White)	
		Video	1 x DVI-I Female (White)	2 x DVI-I Female (White)
		Mouse	1 x USB Type A Female (White)	
		Speaker	1 x Mini Stereo Jack Female (Green)	
		Mic.	1 x Mini Stereo Jack Female (Pink)	
		RS-232	1 x DB-9 Male (Black)	
	KVM Ports	KB / Mouse	USB Type B Female (White)	
		Speaker	1 x Mini Stereo Jack (Green)	
		Mic.	1 x Mini Stereo Jack (Pink)	
		Video	1 x DVI-I Female (White)	2 x DVI-I Female (White)
		RS-232	1 x DB-9 Female (Black)	
	Power		1 x DC Jack (Black)	
	LAN		1 x RJ-45 Female (Black)	
	Switches	Console Selection / Config		1 x Slide switch (Black) (Auto, Local, Config)
Reset		1 x Semi-recessed Pushbutton		
LEDs	LAN		1 (Green / Orange)	
	Power		1 x Blue	
	Local		1 x Green	
	Remote		1 x Green	
Emulation	Keyboard / Mouse		USB	
Power Consumption		DC 5V	DC 5V	
Video		Up to 1920 x 1200		
Environment	Operating Temp.		0–50°C	
	Storage Temp		-20–60°C	
	Humidity		0–95% RH, Non-condensing	
Physical Properties	Housing		Metal	
	Weight		1.13 kg	1.15 kg
	Dimensions (L x W x H)		21.50 x 16.30 x 4.60 cm	

Function		KE6900R	KE6940R	
Connectors	USB Virtual Media		2 x USB Type A Female (White)	
	Console Ports	Keyboard	1 x USB Type A Female (White)	
		Video	1 x DVI-I Female (White)	2 x DVI-I Female (White)
		Mouse	1 x USB Type A Female (White)	
		Speaker	1 x Mini Stereo Jack Female (Green)	
		Mic.	1 x Mini Stereo Jack Female (Pink)	
	RS-232		1 x DB-9 Male (Black)	
	Power		1 x DC Jack (Black)	
	LAN		1 x RJ-45 Female (Black)	
Switches	OSD		1 x Pushbutton	
	Video		1 x Pushbutton	
	Graphics		1 x Pushbutton	
	Console Selection / Config		1 x Slide switch (Black) (Auto, Config)	
	Reset		1 x Semi-recessed Pushbutton	
LEDs	LAN		1 (Green / Orange)	
	Power		1 x Blue	
	Local		1 x Green	
	Remote		1 x Green	
Emulation	Keyboard / Mouse		USB	
Power Consumption		DC 5V	DC 5V	
Video		Up to 1920 x 1200		
Environment	Operating Temp.		0–50°C	
	Storage Temp		-20–60°C	
	Humidity		0–95% RH, Non-condensing	
Physical Properties	Housing		Metal	
	Weight		1.25 kg	1.25 kg
	Dimensions (L x W x H)		22.80 x 17.10 x 55.00 cm	

Optional Rack Mounting

For convenience and flexibility, two optional rack mounting kits are available as shown in the following table:

Mounting Type	Model
KE69 Dual Rack Mount Kit	2X-021G
KE69 Single Rack Mount Kit	2X-031G

Dual Rack Mounting

The 2X-021G Dual Rack Mounting Kit installs two KE6900 units side by side in 1U of server rack space.

1. Remove four screws from the KE6900 units and then use the same screws to secure the units together with the link bracket.

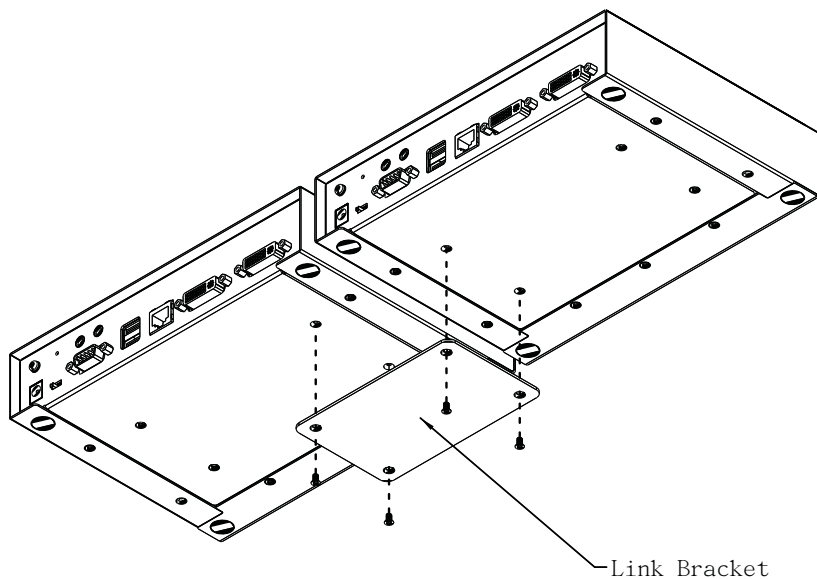

(Continues on next page.)

2. Remove the bottom and side screw from each KE6900 unit.

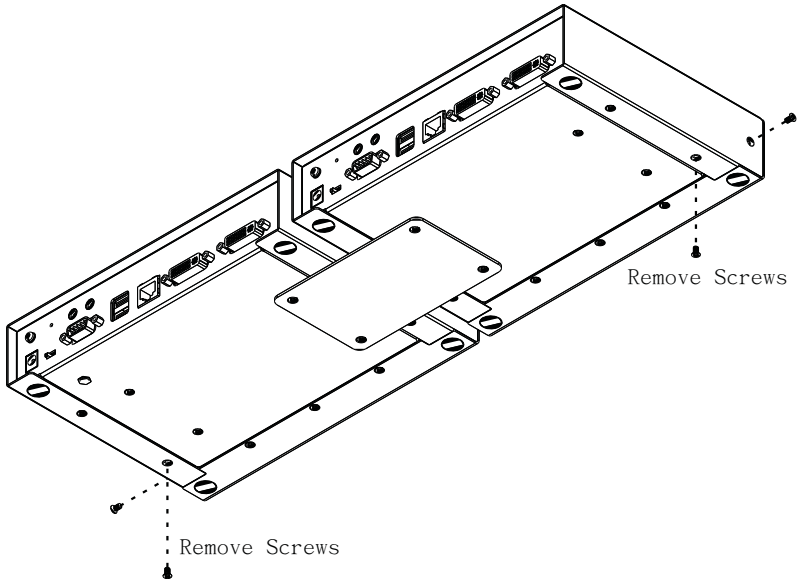

3. Use the screws in step 2 to install the left and right mounting brackets.

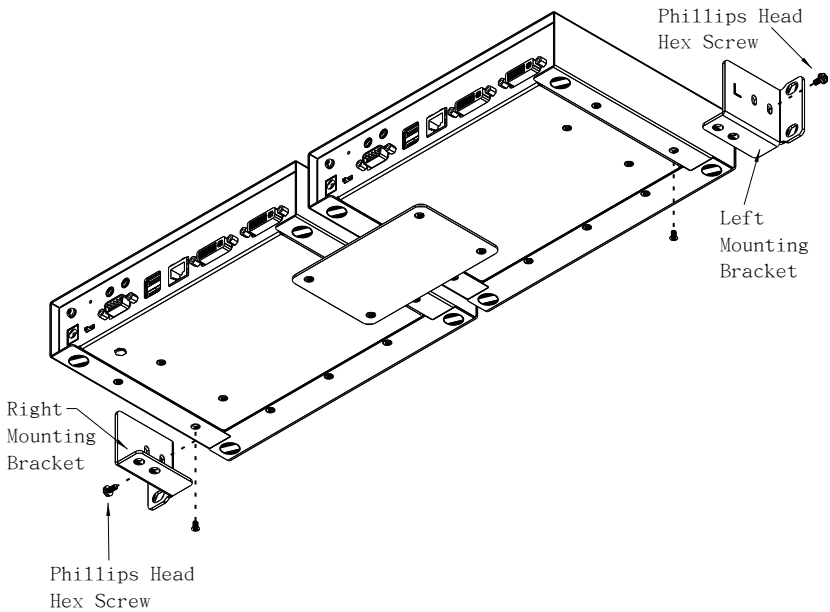

4. Screw the mounting brackets to the rack.

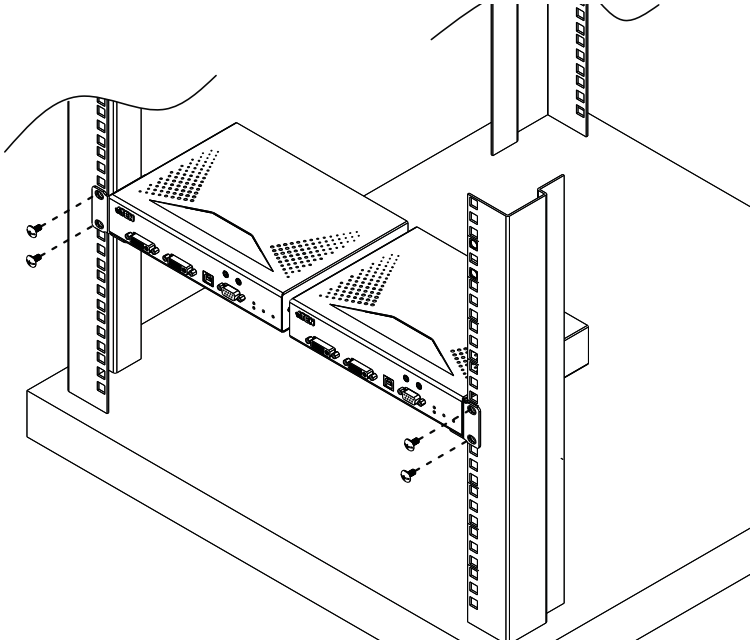

Single Rack Mounting

The 2X-031G Single Rack Mounting kit installs one KE6900 unit in 1U of server rack space.

1. Remove the eight screws and plastic guards from the KE6900.

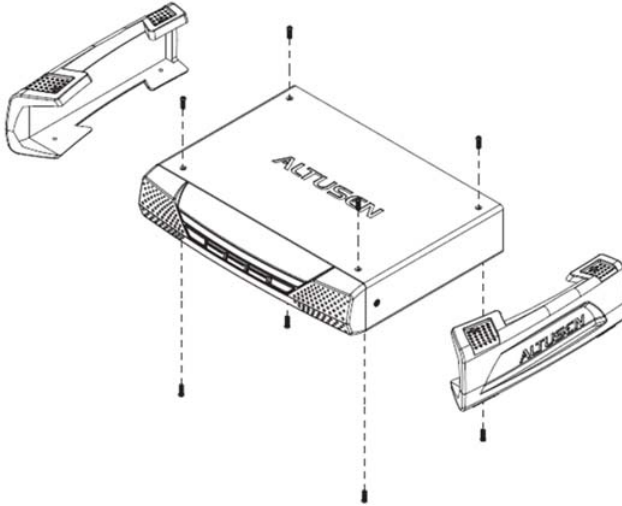

2. Remove the bottom and side screws from the KE6900.

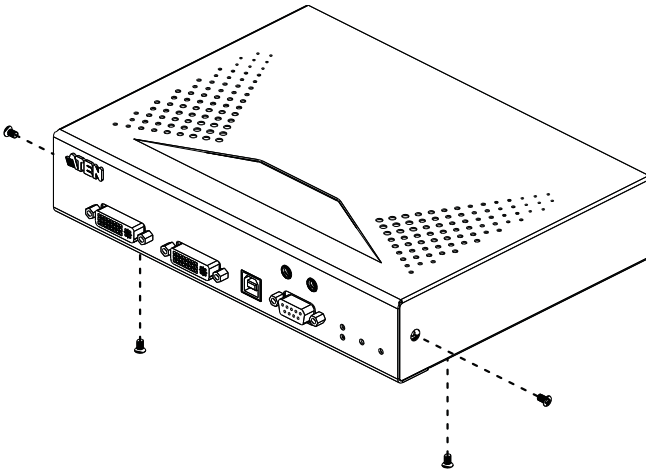

- Use the screws in step 2 to install the right and left mounting brackets.

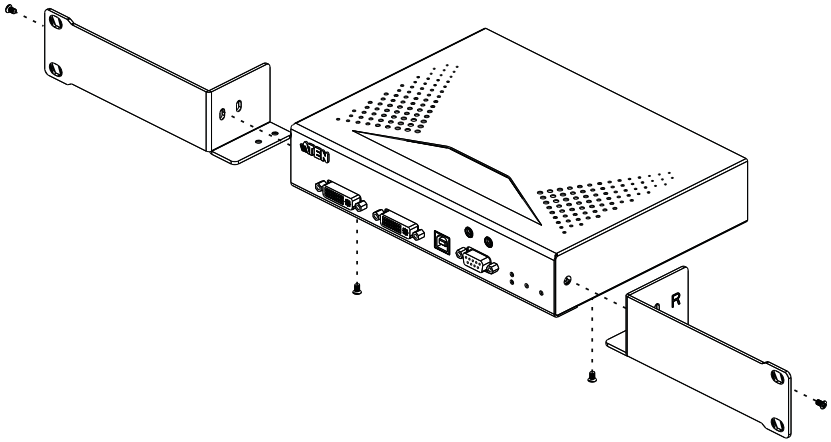

- Screw the mounting brackets to the rack.

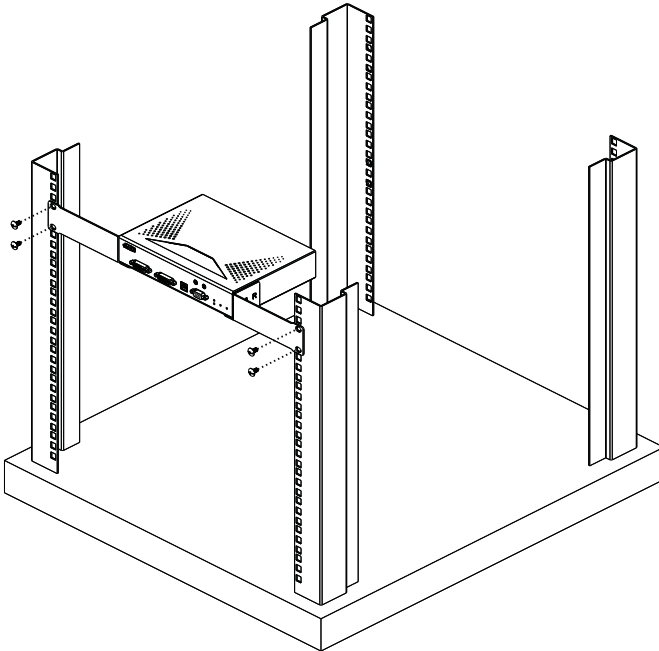

IP Installer

From a client computer running Windows, an IP address for a transmitter or receiver can be assigned with the IP Installer utility. The utility can be obtained from the Download area of our website or from the KE6900 product page on the *Resources* tab under *Software & Driver*. After downloading the utility to your client computer, do the following:

1. Unzip the contents of IPInstaller.zip to a directory on your hard drive.
2. Go to the directory that you unzipped the IPInstaller program to and run IPInstaller.exe. A dialog box similar to the one below appears:

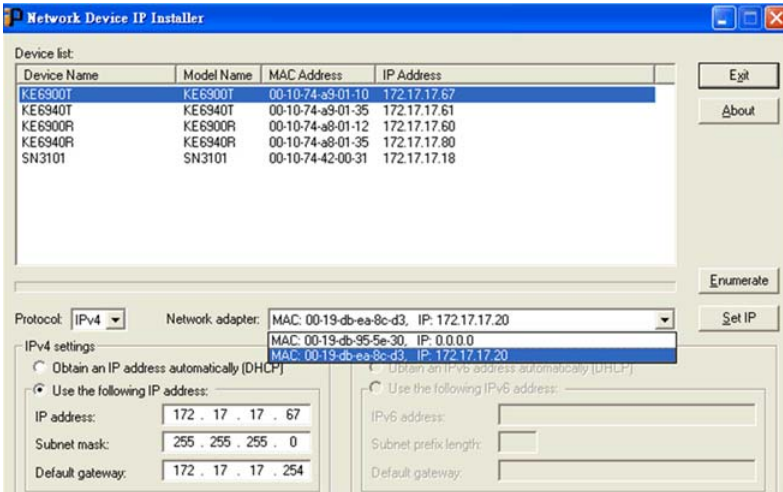

3. Select the Transmitter or Receiver in the Device List.

Note: 1. If the list is empty, or your device doesn't appear, click **Enumerate** to refresh the Device List.

2. If there is more than one device in the list, use the MAC address to pick the one you want. The MAC address is located on the devices bottom panel.

4. Select either *Obtain an IP address automatically (DHCP)*, or *Specify an IP address*. If you chose the latter, fill the IP Address, Subnet Mask, and Gateway fields with the information appropriate to your network.
5. Click **Set IP**.
6. After the IP address shows up in the Device List, click **Exit**.

Trusted Certificates

Overview

When you try to log in to the device from your browser, a Security Alert message appears to inform you that the device's certificate is not trusted, and asks if you want to proceed.



The certificate can be trusted, but the alert is triggered because the certificate's name is not found on the Microsoft list of Trusted Authorities. You can ignore the warning and click **Yes** to go on.

Self-Signed Private Certificates

If you wish to create your own self-signed encryption key and certificate, a free utility – `openssl.exe` – is available for download over the web at www.openssl.org. To create your private key and certificate do the following:

1. Go to the directory where you downloaded and extracted *openssl.exe* to.
2. Run `openssl.exe` with the following parameters:

```
openssl req -new -newkey rsa:1024 -days 3653 -nodes -x509  
-keyout CA.key -out CA.cer -config openssl.cnf
```

-
- Note:**
1. The command should be entered all on one line (i.e., do not press [Enter] until all the parameters have been keyed in).
 2. If there are spaces in the input, surround the entry in quotes (e.g., “ATEN International”).
-

To avoid having to input information during key generation the following additional parameters can be used:

```
/C /ST /L /O /OU /CN /emailAddress.
```

Examples

```
openssl req -new -newkey rsa:1024 -days 3653 -nodes -x509  
-keyout CA.key -out CA.cer -config openssl.cnf -subj  
"/C=yourcountry/ST=yourstateorprovince/L=yourlocationor  
city/O=yourorganization/OU=yourorganizationalunit/  
CN=yourcommonname/emailAddress=name@yourcompany.com
```

```
openssl req -new -newkey rsa:1024 -days 3653 -nodes -x509  
-keyout CA.key -out CA.cer -config openssl.cnf -subj  
"/C=CA/ST=BC/L=Richmond/O=ATEN International/OU=ATEN  
/CN=ATEN/emailAddress=eservice@aten.com.tw
```

Importing the Files

After the `openssl.exe` program completes, two files – `CA.key` (the private key) and `CA.cer` (the self-signed SSL certificate) – are created in the directory that you ran the program from.

RS-232 Pin Assignments

Pin assignments for the Transmitter and Receiver's rear RS-232 port that is used for connecting to a serial terminal are given in the table, below:

Pin	Assignment	
1	N/A	None
2	RXD	Receive Data
3	TXD	Transmit Data
4	DTR	Data Terminal Ready
5	GND	Signal Ground
6	DSR	Data Set Ready
7	RTS	Request to Sent
8	CTS	Clear to Sent
9	N/A	None

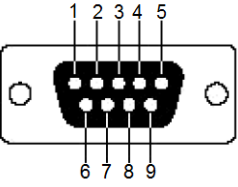

DB9 Male

Transmitter Front RS-232 Port

Pin assignments for the Transmitter's front RS-232 port that is used for connecting to a computer for serial control are given in the table, below:

Pin	Assignment	
1	N/A	None
2	TXD	Transmit Data
3	RXD	Receive Data
4	DSR	Data Set Ready
5	GND	Signal Ground
6	DTR	Data Terminal Ready
7	CTS	Clear to Sent
8	RTS	Request to Sent
9	N/A	None

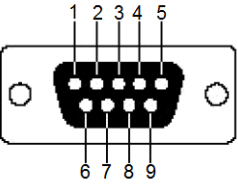

DB9 Female

Multicast IP Address

Multicasting helps to broadcast audio and video data from a transmitter to multiple user stations over a network. To setup up Multicasting on a network switch you must know the Audio and Video Multicast IP address which can be found on the KE Transmitter. To determinate the default Multicast IP address set by the KE device use the instructions below. The Multicast IP addresses can be set manually using Telnet.

KE Multicast Rule

All Audio and Video Multicast IP addresses use the format: 230.X.Y.Z.

X.Y.Z relates to the Transmitter's IP address and **230** is always the first octet of a Multicast IP address. You use the Transmitter's IP address to find **X** and then use it to calculate the Audio and Video Multicast IP address.

Multicast IP Formula

To calculate the Audio and Video Multicast IP address, use the Transmitter's IP address to determine **X** and then use the appropriate table below to calculate the Multicast IP address for each data stream (audio/video).

Example:

Transmitter IP Address: 172.**16**.27.146; (172.**X**.Y.Z)

X =16

If X is between 0 ~ 127

Transmitter IP	X	Video X + 128	Audio X + 192	Multicast Video IP Address	Multicast Audio IP Address
172. 16 .27.146 (example)	16	<u>16</u> + 128 = 144	<u>16</u> + 192 = 208	230. 144 .27.146	230. 208 .27.146
		___ + 128 =	___ + 192 =	230.____.____.	230.____.____.
		___ + 128 =	___ + 192 =	230.____.____.	230.____.____.
		___ + 128 =	___ + 192 =	230.____.____.	230.____.____.

If X is between 128 ~ 192

Transmitter IP	X - 128 = A	Video A + 128	Audio A + 192	Multicast Video IP Address	Multicast Audio IP Address
172.168.27.14 (example)	168 - 128 = 40	40 + 128 = 168	40 + 192 = 232	230.168.27.14	230.232.27.14
	___ - 128 =	___ + 128 =	___ + 192 =	230.____.____.____	230.____.____.____
	___ - 128 =	___ + 128 =	___ + 192 =	230.____.____.____	230.____.____.____
	___ - 128 =	___ + 128 =	___ + 192 =	230.____.____.____	230.____.____.____

If X is 192 or higher

Transmitter IP	X - 192 = A	Video A + 128	Audio A + 192	Multicast Video IP Address	Multicast Audio IP Address
172.200.27.14 (example)	200 - 192 = 8	8 + 128 = 136	8 + 192 = 200	230.136.27.14	230.200.27.14
	___ - 192 =	___ + 128 =	___ + 192 =	230.____.____.____	230.____.____.____
	___ - 192 =	___ + 128 =	___ + 192 =	230.____.____.____	230.____.____.____
	___ - 192 =	___ + 128 =	___ + 192 =	230.____.____.____	230.____.____.____

Keys to Network Performance

For optimum performance, the KE6900 requires high amounts of data to be transferred across a network; therefore we recommend the following strategies to setup the KE6900 devices. Using our suggestions will provide better performance and the highest video resolutions possible. Use each of the keys to ensure the best transmission of data and the highest throughput possible.

Build a Network Diagram

To build an effective KE installation, start by mapping out the layout. Create a diagram with the KE devices, computers and routers along with how they will be connected across the network. It also helps to write out how the devices will interact. Use this diagram as the frame work as you decide what devices to purchase and how to build the network effectively for the best data throughput.

Considerations:

- ◆ If possible, create a private network for the KE devices
- ◆ Use the same switch model throughout
- ◆ Use a flat cascaded layout
- ◆ Avoid a tree or pyramid structure
- ◆ Limit cascades to two levels
- ◆ Install network switches near each other
- ◆ Minimize the distance of connections
- ◆ Install Matrix Manger (CCKM) computer and KE devices on the same subnet
- ◆ Check the 3 Other Factors before installation

Other Factors

■ Choose the Right Cable

Always use Cat 5/6e Ethernet cable or higher installed by a professional between any two devices you are installing. We recommend using ATEN Brand Ethernet cable to ensure the quality. It's best when installing KE devices to use brand new Ethernet cabling for each part of the installation to ensure the reliability of the data being transmitted. This is a key to getting the best uninterrupted video resolution across the network.

■ Determine the Distance

Distance is an important factor when setting up networks, with a shorter distance and fewer hops through routers, data can be transmitted more efficiently. So whenever possible decrease the distance and direct network traffic effectively between subnets that communicate with each other to increase the data throughput.

■ Ensure the Bandwidth

Ensuring the bandwidth ahead of time will guarantee performance before installing KE devices on a network. This will eliminate the primary cause of problems related to video quality and transmission of data. If the speed is right at all ends of your network, then the only other causes are derived from device failure or limits caused by a router, switch or device setting.

Sample Network Diagram

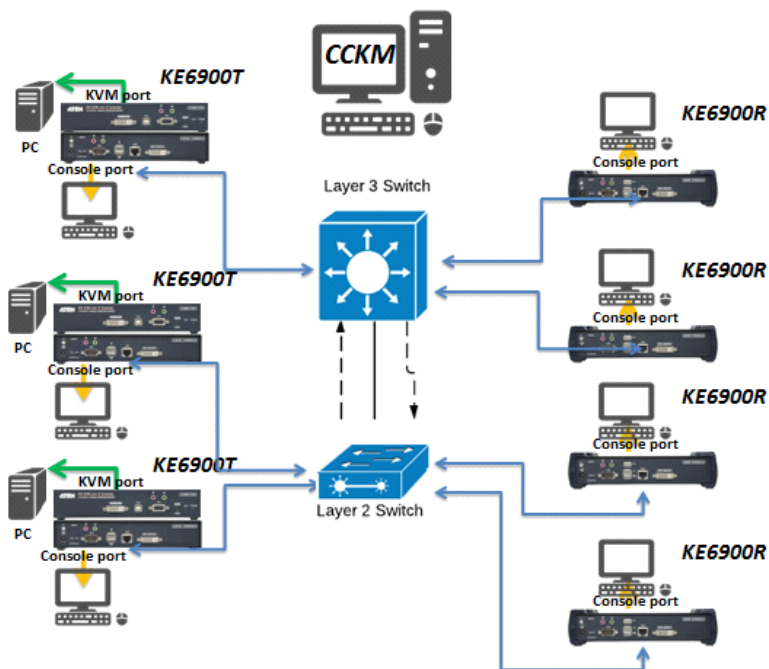

Choose a High Performance Switch

A high performance network switch is the means of a successful KE setup. When choosing a network switch, first select the type:

Layer 2 or Layer 3 Switches

You'll need to determine whether you need a layer 2 or a layer 3 switch for your KE network. Layer 3 switches cost more than layer 2 switches because they are more complex and handle more network traffic. The best way to calculate which type of switch you need is to first determine if you will have a dedicated network for the KE devices or if the KE devices will be on a network that shares throughput with other network equipment such as computers, servers and printers. If they share the network with other devices its best to consider a layer 3 switch and use layer 2 switches exclusively for the KE device connections. For larger installations we recommend using Layer 3 switches. The major differences are:

Layer 3 Switch: IP addresses in packets are examined and intelligent forwarding decisions are made. On a larger network broken into subnets across long distances, a layer 3 switch becomes the best choice as they can improve network efficiency and provide better traffic flow. They are better at directing more traffic to different locations on a larger more complex network, and with layer two switches working below them.

Layer 2 Switch: Packets are examined and forwarded using only the MAC address. If you have a small central network, a layer 2 switch should do the job. If the network is exclusive and will only transmit the bandwidth of KE devices, layer 2 switches with the correct settings can get the job done effectively.

Considerations

Number of ports

Choose a switch that has enough ports to match the number of KE devices you will be installing. Switches typically come in 5, 8, 10, 16, 24, 28, 48, and 52-port configurations. If you are installing 13 KE transmitters and 13 KE receivers, you will need to purchase a switch with at least 28 ports.

Stackable verse Standalone

Stackable switches allow you to easily manage and configure ports spanning across multiple switches that the KE devices are connected through. This provides a centralized method to configure and troubleshoot the initial setup of

KE devices on a network which makes fine tuning the bandwidth, data throughput and video quality easier. Stackable switches can be configured to direct the KE transmissions between many units more specifically and effectively. Standalone switches provide the same configuration features as Stackable switches but they must be set individually.

Stackable switches provide an easy way to manage multiple switches, as one unit. For example, instead of configuring, managing, and troubleshooting 6 28-port switches individually, you can manage the six as if they are a single unit using Stackable Switches. The six switches (168 ports) function as a single switch and are managed from one web or GUI interface.

What Stackable Switches Can do:

1. Create a link aggregation group with one port in one unit of the stack and another port of that group in another switch in the stack.
2. Select a port on one switch in the stack and mirror the traffic to a switch port on another unit of the stack; thus copy the configuration to direct traffic more effectively between KE devices.
3. Apply custom ACL security settings to any port on any switch in the stack.
4. Stackable switches can be setup in a ring configuration, so that if a port or cable fails, the stack automatically routes around the failure, at microsecond speeds. Stackable Switches also allow you to add and remove stack “members” which are automatically updated and recognized as such.

Switch Specifications

The following specifications are recommended when choosing a layer 2 or layer 3 switch:

- ◆ 1000Mbps Gigabit Ethernet switches (1000Mbps or faster Ethernet ports)
- ◆ High bandwidth between switches, if possible using Fibre Channel
- ◆ Layer 3 switches that efficiently processes IGMP queries
- ◆ IGMP Snooping v2 or v3
- ◆ Flow Control Functions
- ◆ Throughput of: Full Duplex, 1Gbps up- and down- stream speeds per port
- ◆ Performance of their most onerous tasks (e.g. IGMP snooping) with multiple dedicated processors (ASICS)
- ◆ Use the same switch make and model throughout each subnet

- ◆ The maximum number of simultaneous ‘snoopable groups’ the switch can handle meets or exceeds the number of KE transmitters that will be used to create Channel groups

Configuring Switches and KE Devices

Configuring the switch correctly will pass data more efficiently, allowing a better stream across the network to each KE device. The following settings will help optimize your network traffic through a switch:

- ◆ Enable IGMP Snooping on L2 switches
- ◆ Enable IGMP Querier on the L3 switch
- ◆ Enable IGMP Fast-Leave on all switches where KE units are directly connected
- ◆ Enable Spanning Tree Protocol (STP) on all switches and enable Portfast exclusively on switch ports that have KE units connected
- ◆ Pick an appropriate forwarding mode on all switches. Use Cut-through if available, or Store and Forward

KE transmitter Settings:

- ◆ Adjust the KE transmitter settings one at a time, in small intervals, and view the images as you do, so that you can adjust to the positive or negative results and achieve the best quality and bandwidth possible
- ◆ If the quality of color is important, set the Color Depth to 24 bits and manually adjust other settings until you are satisfied with the visual appearance
- ◆ If moving video images are shown frequently, increase the Video Quality setting to the highest level and reduce the Bandwidth Limit and Color Depth setting.
- ◆ When images on the screen are more often static, increase the Background Refresh and/or the Video Quality settings
- ◆ Check that all KE units have been updated with the latest firmware version

Limited Warranty

ALTUSEN warrants this product against defects in material or workmanship for a period of one (1) year from the date of purchase. If this product proves to be defective, contact ALTUSEN's support department for repair or replacement of your unit. ALTUSEN will not issue a refund. Return requests can not be processed without the original proof of purchase.

When returning the product, you must ship the product in its original packaging or packaging that gives an equal degree of protection. Include your proof of purchase in the packaging and the RMA number clearly marked on the outside of the package.

This warranty becomes invalid if the factory-supplied serial number has been removed or altered on the product.

This warranty does not cover cosmetic damage or damage due to acts of God, accident, misuse, abuse, negligence or modification of any part of the product. This warranty does not cover damage due to improper operation or maintenance, connection to improper equipment, or attempted repair by anyone other than ALTUSEN. This warranty does not cover products sold AS IS or WITH FAULTS.

IN NO EVENT SHALL ALTUSEN'S LIABILITY EXCEED THE PRICE PAID FOR THE PRODUCT. FURTHER, ALTUSEN SHALL NOT BE RESPONSIBLE FOR DIRECT, INDIRECT, SPECIAL, INCIDENTAL OR CONSEQUENTIAL DAMAGES RESULTING FROM THE USE OF THE PRODUCT, ITS ACCOMPANYING SOFTWARE, OR ITS DOCUMENTATION. ALTUSEN SHALL NOT IN ANY WAY BE RESPONSIBLE FOR, WITHOUT LIMITATION, LOSS OF DATA, LOSS OF PROFITS, DOWNTIME, GOODWILL, DAMAGE OR REPLACEMENT OF EQUIPMENT OR PROPERTY, AND ANY EXPENSES FROM RECOVERY, PROGRAMMING, AND REPRODUCTION OF ANY PROGRAM OR DATA.

ALTUSEN makes no warranty or representation, expressed, implied, or statutory with respect to its products, contents or use of this documentation and all accompanying software, and specifically disclaims its quality, performance, merchantability, or fitness for any particular purpose.

ALTUSEN reserves the right to revise or update its product, software or documentation without obligation to notify any individual or entity of such revisions, or update.

For details about extended warranties, please contact one of our dedicated value added resellers.

This Page Intentionally Left Blank

Index

A

- Adding a New Device, 71
- Adding Users, 106

B

- Backup / Restore, 138

C

- Components, 5
- Configuring a Device, 82
- Control Center
 - Screen Components, 54
 - User Interface, 29
- Creating Groups, 109

D

- Deleting a Device, 76, 86
- Deleting groups, 110
- Deleting user accounts, 108
- Device Permissions
 - assigning, 115, 117, 118

F

- Filter, 136
- Firmware
 - upgrading, 137
- Firmware Upgrade, 147
- Firmware upgrade recovery, 141

G

- Groups
 - assigning users, 111, 113
 - creating, 109
 - Deleting, 110
 - Managing, 109
 - Modifying, 110

- removing users, 112, 114

L

- Log, 133
 - filter, 136

M

- Maintenance, 137
- Managing Groups, 109
- Managing Users, 106
- Modifying groups, 110
- Modifying user accounts, 108

O

- Online
 - Registration, iv

P

- Password
 - System administrator, 40, 53
- Port Access
 - filter log, 136
- Preferences, 145
- Private Certificates, 196

R

- Rack mounting, 13, 15
- Requirements
 - Operating Systems, 4
 - OS Support, 4
- RoHS, iii

S

- Safety Instructions
 - General, 183
 - Rack Mounting, 185
- Self-signed certificates, 196

SJ/T 11364-2006, iii
Specifications, 187
System administrator password, 40,
53
System Requirements
Computers, 3

T

Tab bar, 56
Technical Support, 186
Telephone support, iv
Tree View, 55
Trusted Certificates, 195

U

Upgrade firmware, 137
User Interface, 29
Tab bar, 56
User Management, 105
User Notice, iv
User Preferences, 145
Users
Adding, 106
assigning to groups, 111, 113
Deleting, 108
Managing, 106
Modifying, 108
removing from groups, 112, 114
Users and Groups, 111