



## ATEN Control System User Manual



[www.aten.com](http://www.aten.com)

## EMC Information

---

### FEDERAL COMMUNICATIONS COMMISSION INTERFERENCE STATEMENT

This equipment has been tested and found to comply with the limits for a Class A digital device, pursuant to Part 15 of the FCC Rules. These limits are designed to provide reasonable protection against harmful interference when the equipment is operated in a commercial environment. This equipment generates, uses, and can radiate radio frequency energy and, if not installed and used in accordance with the instruction manual, may cause harmful interference to radio communications. Operation of this equipment in a residential area is likely to cause harmful interference in which case the user will be required to correct the interference at his own expense.

**FCC Caution:** Any changes or modifications not expressly approved by the party responsible for compliance could void the user's authority to operate this equipment.

**CE Warning:** This equipment is compliant with Class A of CISPR 32. In a residential environment this equipment may cause radio interference.

### KCC Statement

유선 제품용 / A 급 기기 ( 업무용 방송 통신 기기 )

이 기기는 업무용 ( A 급 ) 전자파적합기기로서 판매자 또는 사용자는 이 점을 주의하시기 바라며 , 가정 외의 지역에서 사용하는 것을 목적으로 합니다 .

## RoHS

---

This product is RoHS compliant.

## Safety

---

This product has been classified as Information Technology Equipment.



## SJ/T 11364-2006

The following contains information that relates to China.

部件名称	有毒有害物质或元素					
	铅	汞	镉	六价铬	多溴联苯	多溴二苯醚
电器部件	●	○	○	○	○	○
机构部件	○	○	○	○	○	○

- : 表示该有毒有害物质在该部件所有均质材料中的含量均在SJ/T 11363-2006规定的限量要求之下。
- : 表示符合欧盟的豁免条款，但该有毒有害物质至少在该部件的某一均质材料中的含量超出SJ/T 11363-2006的限量要求。
- ×: 表示该有毒有害物质至少在该部件的某一均质材料中的含量超出SJ/T 11363-2006的限量要求。

## **User Information**

---

### **Online Registration**

Be sure to register your product at our online support center:

---

International	<a href="http://eservice.aten.com">http://eservice.aten.com</a>
---------------	---

---

### **Telephone Support**

For telephone support, call this number:

---

International	886-2-8692-6959
China	86-10-5255-0110
Japan	81-3-5615-5811
Korea	82-2-467-6789
North America	1-888-999-ATEN ext 4988
United Kingdom	44-8-4481-58923

---

### **User Notice**

All information, documentation, and specifications contained in this manual are subject to change without prior notification by the manufacturer. The manufacturer makes no representations or warranties, either expressed or implied, with respect to the contents hereof and specifically disclaims any warranties as to merchantability or fitness for any particular purpose. Any of the manufacturer's software described in this manual is sold or licensed *as is*. Should the programs prove defective following their purchase, the buyer (and not the manufacturer, its distributor, or its dealer), assumes the entire cost of all necessary servicing, repair and any incidental or consequential damages resulting from any defect in the software.

The manufacturer of this system is not responsible for any radio and/or TV interference caused by unauthorized modifications to this device. It is the responsibility of the user to correct such interference.

The manufacturer is not responsible for any damage incurred in the operation of this system if the correct operational voltage setting was not selected prior to operation. **PLEASE VERIFY THAT THE VOLTAGE SETTING IS CORRECT BEFORE USE.**

## Package Contents

---

The VK2100 package consists of:

- ◆ 1 VK2100 ATEN Controller
- ◆ 1 Rack Mount Kit
- ◆ 9 Terminal Blocks
- ◆ 1 Power Cord
- ◆ 1 User Instructions\*

Check to make sure that all the components are present and that nothing got damaged in shipping. If you encounter a problem, contact your dealer.

Read this manual thoroughly and follow the installation and operation procedures carefully to prevent any damage to the unit, and/or any of the devices connected to it.

---

\* Features may have been added to the ATEN Control System since this manual was published. Please visit our website to download the most up-to-date version.

---

© Copyright 2016 ATEN® International Co., Ltd.  
Manual Date: 2016-10-13

ATEN and the ATEN logo are registered trademarks of ATEN International Co., Ltd. All rights reserved.  
All other brand names and trademarks are the registered property of their respective owners.

# Contents

---

EMC Information . . . . .	ii
Safety . . . . .	ii
SJ/T 11364-2006 . . . . .	iii
User Information . . . . .	iv
Online Registration . . . . .	iv
Telephone Support . . . . .	iv
User Notice . . . . .	iv
Package Contents . . . . .	v
Contents . . . . .	vi
About this Manual . . . . .	ix
Conventions . . . . .	x
Product Information . . . . .	x

## Chapter 1.

### Introduction

Overview . . . . .	1
Expandable and Manageable Device Library . . . . .	2
Simplified Setup via Intuitive GUI . . . . .	2
Facilitation with Multiple Controller/Profile/Mobile Control . . . . .	2
Features . . . . .	3
VK2100 (Hardware Controller) . . . . .	3
VK6000 (Configurator Software) . . . . .	3
ATEN Control System App . . . . .	3
Requirements . . . . .	4
Hardware Devices . . . . .	4
Cables . . . . .	4
Computer & Software . . . . .	4
Minimum PC Requirements (VK6000) . . . . .	4
Components . . . . .	5
Front View . . . . .	5
Rear View . . . . .	7

## Chapter 2.

### Hardware Setup

Rack Mounting . . . . .	9
Connections . . . . .	11
Installation Diagram . . . . .	12
12VDC Power Output . . . . .	13
Relay . . . . .	17
IR / Serial . . . . .	18
One IR Transmitter . . . . .	19
Two IR Transmitters . . . . .	19
Digital I/O . . . . .	20
RS-232 . . . . .	22
RS-232 / 422 / 485 . . . . .	23

Ethernet . . . . .	24
Expansion Box . . . . .	25
ATEN Expansion Boxes . . . . .	25

**Chapter 3.  
Browser Operation**

Overview . . . . .	27
Logging In . . . . .	27
Dashboard . . . . .	28
Settings . . . . .	29
Licenses . . . . .	30
Capacity . . . . .	31
Access Key . . . . .	32
Monitor . . . . .	33
Network . . . . .	34

**Chapter 4.  
Software Installation**

Overview . . . . .	35
Configurator Software . . . . .	35
Installation . . . . .	35

**Chapter 5.  
ATEN Configurator (VK6000)**

Overview . . . . .	39
Preface . . . . .	39
Main Page . . . . .	40
Menu Bar . . . . .	41
Project Information . . . . .	46
Select Device & Configuration . . . . .	47
Device Configuration . . . . .	48
Left Sidebar . . . . .	49
Room . . . . .	49
Expander . . . . .	49
Right Sidebar . . . . .	50
Device Library . . . . .	51
Properties . . . . .	52
Create Viewer & Design . . . . .	55
Select Viewer . . . . .	56
Left Sidebar . . . . .	58
Pages . . . . .	58
Right Sidebar . . . . .	58
Page Overview . . . . .	59
Edit . . . . .	60
General . . . . .	65
Action . . . . .	66
Graphic Library . . . . .	78
Background . . . . .	78

Button . . . . .	78
Icon . . . . .	79
Device Interface . . . . .	79
Advanced Editor . . . . .	80
Macro . . . . .	81
Monitor . . . . .	83
Flag . . . . .	88
Search & Upload. . . . .	90

**Chapter 6.**  
**ATEN Database Generator**

Overview . . . . .	93
My Library . . . . .	94
Managing My Library. . . . .	96
Edit / Add New Device. . . . .	97
ATEN Library. . . . .	106

**Chapter 7.**  
**ATEN Control System App**

Overview . . . . .	107
Installing the App . . . . .	107
Button Sounds. . . . .	107
ATEN Control System App . . . . .	108
Demo . . . . .	109
Room-101 . . . . .	109
Room-102 . . . . .	110
Welcome . . . . .	112
Edit Viewer Profile. . . . .	113
Manage LAN Device . . . . .	114
Controller. . . . .	114
Set Password . . . . .	117
Log Report . . . . .	118
Information . . . . .	119
Download Viewer Profile. . . . .	120
Downloading Profiles . . . . .	121

**Appendix**

Safety Instructions . . . . .	123
General . . . . .	123
Rack Mounting . . . . .	125
Technical Support. . . . .	126
International . . . . .	126
North America . . . . .	126
Specifications . . . . .	127
Limited Warranty. . . . .	129



## About this Manual

---

This User Manual is provided to help you get the most from your ATEN Control System. It covers all aspects of installation, configuration and operation. An overview of the information found in the manual is provided below.

**Chapter 1, Introduction**, introduces you to the ATEN Control System. Its purpose, features and benefits are presented, and the VK2100's front and back panel components are described.

**Chapter 2, Hardware Setup**, provides the necessary steps to setup the VK2100 installation, including how to wire the different types of hardware connections.

**Chapter 3, Browser Operation**, provides a complete description of the VK2100's Browser Graphical User Interface (GUI) and how to use it to remotely configure parts of the VK2100 installation.

**Chapter 4, Software Installation**, explains the steps required to download and install the VK6000 software.

**Chapter 5, ATEN Configurator (VK6000)**, provides a complete description of the VK6000 software and how to use it to configure and operate the VK2100.

**Chapter 6, ATEN Database Generator**, provides a complete description of the Database Generator software and how to use it to configure new devices to add to the VK6000 device library.

**Chapter 7, ATEN Control System App**, provides a complete description of the ATEN mobile app and how to use it to operate devices connected to the VK2100.

**An Appendix**, provides specifications and other technical information regarding the VK2100.

## Conventions

---

This manual uses the following conventions:

- `Monospaced` Indicates text that you should key in.
- [ ] Indicates keys you should press. For example, [Enter] means to press the **Enter** key. If keys need to be chorded, they appear together in the same bracket with a plus sign between them: [Ctrl+Alt].
1. Numbered lists represent procedures with sequential steps.
- ◆ Bullet lists provide information, but do not involve sequential steps.
- Indicates selecting the option (on a menu or dialog box, for example), that comes next. For example, Start → Run means to open the *Start* menu, and then select *Run*.
-  Indicates critical information.

## Product Information

---

For information about all ATEN products and how they can help you connect without limits, visit ATEN on the Web or contact an ATEN Authorized Reseller. Visit ATEN on the Web for a list of locations and telephone numbers:

International	<a href="http://www.aten.com">http://www.aten.com</a>
North America	<a href="http://www.aten-usa.com">http://www.aten-usa.com</a>

# Chapter 1

## Introduction

### Overview

---

The ATEN Control System, incorporating the VK2100 (ATEN Controller), the VK6000 (ATEN Configurator) and the ATEN Control System App is a standard Ethernet-based management system that connects all hardware devices in a room or large facility to provide centralized control of devices directly and effortlessly via a mobile device. The VK2100 works as the main controller that provides great connectivity to all sorts of hardware devices commonly seen in a room. After connecting the hardware, the VK6000 software allows customizable device configuration via creation of a simple system project in 4 easy steps. By connecting to the VK2100 via Ethernet, the ATEN Control System App empowers you with the mobility to control different hardware devices in different rooms whenever and however you like.

The VK2100 can easily deploy into an existing installation and integrate seamlessly with ATEN VanCryst pro-A/V products and a complete line of hardware devices, including A/V equipment, lighting systems, air conditioning, motion sensors, power switches and much more. The VK2100 serves as a centralized platform where hardware devices are converged to be monitored, managed and controlled directly via a tailor-made GUI from a mobile device.

The VK6000 features a quick setup that facilitates the configuration of hardware control and device operations in 4 easy steps via an intuitive GUI. Through an Ethernet connection, the ATEN Control System App enables you to import and update viewer profiles from the VK2100 via a point-n-tap user interface. Each viewer profile provides a customized control GUI that grants you quick access to target hardware devices. Use of any profile is protected with password authentication to secure system access.

The ATEN Control System is perfectly applicable in meeting rooms, conference centers, boardrooms, classrooms or any room that requires collaboration of a variety of hardware devices through a streamlined management tool with optimum efficiency and performance.

## **Expandable and Manageable Device Library**

The ATEN Library is comprised of 10,000+ device drivers along with the complete line of ATEN VanCryst product drivers. This extensive portfolio of driver resources is built into the system upon the VK6000 installation which makes hardware installation as easy as plug-n-play. This device database can be expanded by adding new devices to the Database Generator which comes in handy when the system fails to locate a specific driver from the ATEN Library. Furthermore, device management is simplified and centralized using My Library which consolidates device information in an organized list for faster hardware setup in projects. This expandable and manageable device database is beneficial and time-efficient as the scope and size of installations grow.

## **Simplified Setup via Intuitive GUI**

The ATEN Configurator (VK6000 software) offers an intuitive and streamlined GUI to simplify a complicated hardware setup process in 4 easy steps: create project > select device > configure viewer profile > upload profile. Operations for any room can be customized in a profile that includes a programmable GUI designed for each mobile device model's screen size, meaning "what you see is what you get". Furthermore, actions and commands that correspond to the control buttons and icons added to the GUI will also be included. All control buttons can then be examined beforehand via Simulator and a test tool to verify how each configuration will respond and appear on the mobile device, allowing you to avoid the need for re-configuration after the profile has been imported to the mobile device for use. This straightforward and streamlined GUI is helpful in boosting the speed of system setup by cutting out repetitive checks, thereby allowing system administrators to quickly become acclimated with device management.

## **Facilitation with Multiple Controller/Profile/Mobile Control**

While plotting your installation, system control can start with one room and scale up to multiple rooms in the same area or across regions. From a mobile device, toggling between profiles imported from the controller (VK2100) facilitates system control of different rooms with simple point-n-tap operations. Meanwhile, multiple mobile devices can be authorized with control over the same room simultaneously, depending on your software license. On the other hand, user access to any profile on the mobile device can be restricted with password authentication to enhance system security. This versatile system framework is beneficial as system control can respond promptly and flexibly to any changes made, without suffering from unexpected service interruptions.

## **Features**

---

### **VK2100 (Hardware Controller)**

- ◆ Supports various connection interfaces, including:
  - ◆ 6 x Serial port
  - ◆ 4 x IR/Serial port
  - ◆ 4 x Relay channel
  - ◆ 4 x I/O channel
  - ◆ 1 x Ethernet port
- ◆ 4 x DC output for power supply connections
- ◆ 1 x USB port for easy profile upload
- ◆ IR Learning function for adding IR device drivers
- ◆ Easy system settings via the web GUI
- ◆ LED indication for hardware status and active messages
- ◆ Rack-mountable

### **VK6000 (Configurator Software)**

- ◆ Simple profile setup in 4 easy configuration steps via intuitive GUI
- ◆ Customizable GUI design and control operations for mobile devices
- ◆ Built-in Database Generator for device driver setup and overall device management
- ◆ Built-in ATEN Library comprising 10,000+ device drivers and complete ATEN VanCryst product drivers
- ◆ Test tool to verify commands in action before uploading the profile to the VK2100
- ◆ Simulator to try out and review the customized GUI before uploading the profile to the VK2100
- ◆ SSH tool to monitor the input and output signals of the controller

### **ATEN Control System App**

- ◆ Controls multiple rooms via multiple profiles imported from the VK2100(s)
- ◆ Restricted user access to profiles via password authentication
- ◆ Synchronization of system controls amongst multiple mobile devices
- ◆ Supports Android, Apple and Windows mobile operating systems

## **Requirements**

---

The following equipment is required for a installation:

### **Hardware Devices**

A device for each type of hardware connection that will be wired to the VK2100, which can include:

- ◆ Bi-directional RS-232/422/485 serial devices
- ◆ One-way IR or serial transmitter hardware devices
- ◆ Relay hardware devices
- ◆ Digital input hardware devices
- ◆ Digital output hardware devices
- ◆ Ethernet controlled PLink, Telnet, ONVIF and TCP devices

### **Cables**

- ◆ Cat 5e/6 Ethernet cable used to connect the VK2100 to the local area network
- ◆ For serial devices with DB9 connectors use standard straight through cables.

### **Computer & Software**

- ◆ PC installed with the ATEN Configurator software (VK6000)
- ◆ Mobile Device installed with the ATEN Control System App

### **Minimum PC Requirements (VK6000)**

Supported operating systems for the ATEN Configurator software (VK6000) are shown in the table, below:

OS	Version
Windows	XP, 7, 8, 8.1 and higher

# Components

## Front View

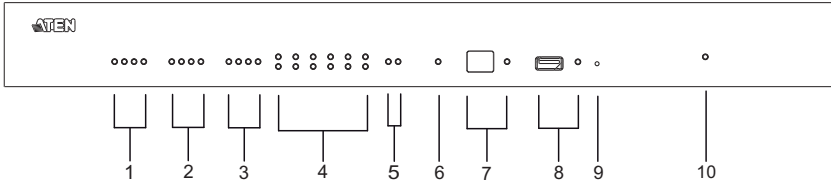

No.	Component	Description
1	Relay LED	The LED lights green to indicate an active device connection (closed loop).
2	IR/Serial LED	The LED lights green to indicate an active device connection and IR/Serial signals are being transmitted.
3	I/O LED	The LED lights green to indicate an active device connection and I/O signals are being transmitted.
4	Serial LED	The LED (1~6) lights green to indicate serial signals are being transmitted.
5	Ethernet LED	The LEDs provide information about the network connection: <ul style="list-style-type: none"> <li>◆ <b>Link:</b> The LED blinks green to indicate Ethernet signals are being transmitted.</li> <li>◆ <b>ACT:</b> The LED lights green to indicate 100Mbps transmissions.</li> </ul>
6	DC Overload LED	The LED lights orange to indicate DC output exceeds maximum output. <b>Note:</b> When the LED lights orange, please unplug any of the connected devices to keep its total output under 24W.
7	IR Receiver / LED	This IR receiver passes the functions of a remote control to the VK2100 in learning mode. The distance between the IR remote and the receiver window should be kept under 10cm with a direct line of sight. <ul style="list-style-type: none"> <li>◆ The LED blinks green to indicate the unit is ready to receive signals from an IR remote control.</li> </ul>

No.	Component	Description
8	USB Port / LED	<p>This is where a USB device plugs in to upload Viewer files to the VK2100.</p> <ul style="list-style-type: none"><li>◆ The LED blinks green to indicate Viewer files are being uploaded, and lights green to indicate a successful upload of Viewer files.</li><li>◆ The LED lights orange to indicate Viewer files failed to upload.</li></ul>
9	Reset	<p>This semi-recessed pushbutton can be pressed to reset the VK2100's network settings.</p>
10	Power LED	<p>Lights green when the unit is turned on.</p>



## Rear View

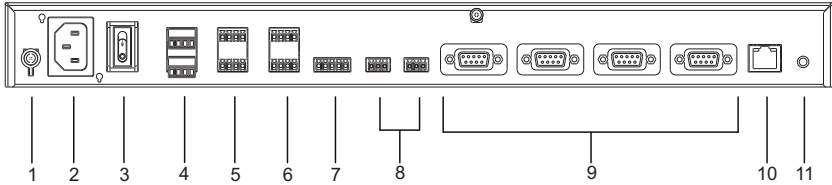

No.	Component	Description
1	Grounding Terminal	The grounding wire attaches here.
2	Power Socket	This is a standard 3-pin AC power socket. The power cord from an AC source plugs in here.
3	Power Switch	This is a standard rocker switch that powers the unit on and off.
4	DC Output Ports	Four outputs provide a total power output of 24W /2A max.
5	Relay Channels	Four channels; normally open, isolated relays with a contact rating of 24VDC, 2A max.
6	IR / Serial Ports	Four IR ports that can also be configured as RS-232 TX ports. pin1: Signal / pin2: Ground.
7	I/O Channels	Four channels that can be configured as digital input or digital output ports. <ul style="list-style-type: none"> <li>◆ Digital Input: 0-24VDC programmable input range or contact closure with +12VDC pull-up</li> <li>◆ Digital Output: 250mA sink from 12VDC</li> </ul> Pin1~4: Signal / Pin5: Ground
8	RS-232 Ports	Two RS-232 ports with TX/RX functions supported.
9	RS-232/422/485 Ports	Four ports with supported RS-232/422/485 conversion by pin assignment and RTS/CTS flow control. The RS232, RS422, or RS485 connection is defined by pin. For pin assignments, see page 23.
10	Ethernet Port	This RJ-45 port is used for the network connection. If no IP address is assigned within 30 seconds, the default IP settings will be used: IP: 192.168.0.60 / mask: 255.255.255.0
11	Controller ID Switch	This 16-segment switch is used for controller ID selection.

This Page Intentionally Left Blank

# Chapter 2

## Hardware Setup



1. Important safety information regarding the placement of this device is provided on page 123. Please review it before proceeding.
2. Make sure that the power to all devices connected to the installation are turned off. You must unplug the power cords of any computers that have the Keyboard Power On function.

### Rack Mounting

---

The VK2100 can be mounted in a 19" (1U) system rack. To install the device in a rack, do the following:

1. Use the M3 x 8 Phillips head hex screws supplied with the Rack Mount Kit to screw the rack mounting brackets onto the front of the unit.

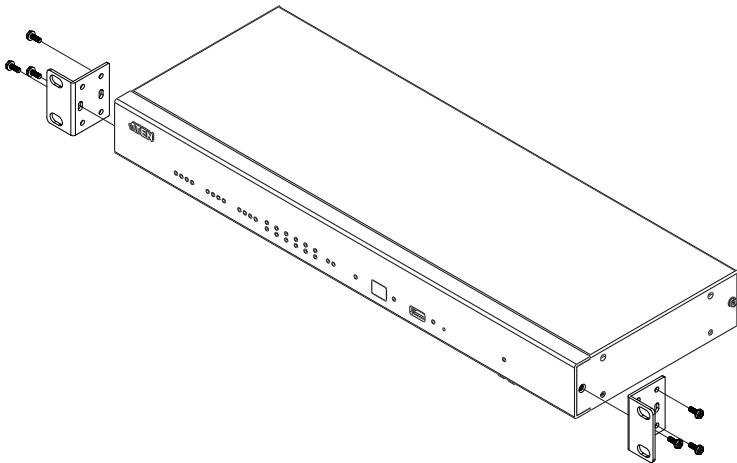

*(Continues on next page.)*

2. Position the unit in the front of the rack and align the holes in the mounting brackets with the holes in the rack.
3. Screw the mounting brackets to the rack.

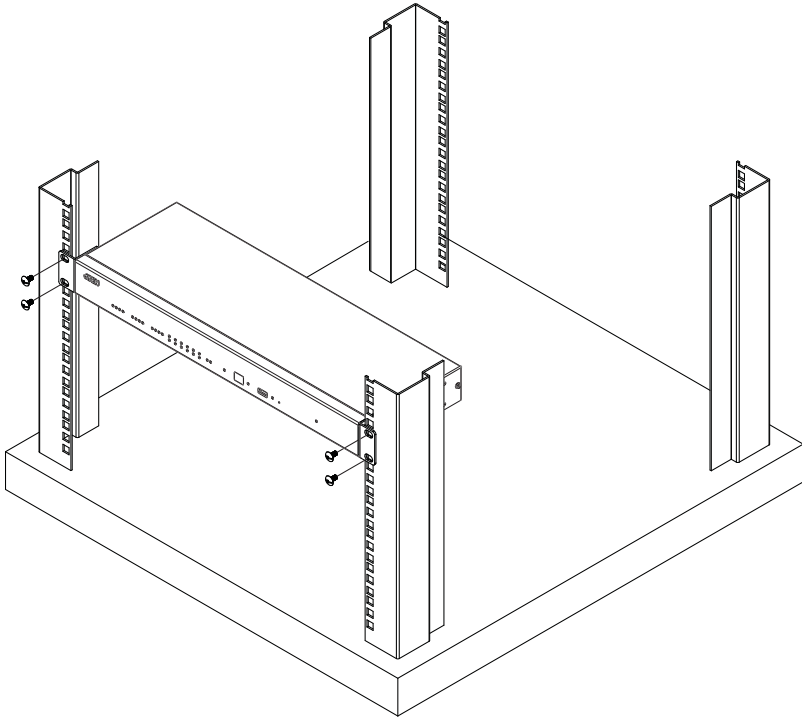

---

## Connections

---

Installation of the VK2100 is a matter of connecting the appropriate wires. Refer to the installation diagrams on the pages that follow to setup each device and use the instructions below as a guide (each step provides a corresponding page with diagram), and do the following:

Connect the hardware devices to the VK2100 using these instructions:

1. Use a grounding wire to ground the unit by connecting one end of the wire to the grounding terminal, and the other end of the wire to a suitable grounded object.

---

**Note:** Do not omit this step. Proper grounding helps to prevent damage to the unit from surges or static electricity.

---

2. Use an Cat 5e/6 cable to connect the VK2100's Ethernet port to the network.
3. Set the Controller ID to the appropriate setting for this unit.
4. Use the DC Output terminals to wire 12VDC power connections using the instructions on page 13.
5. Use the Relay terminals to wire relay device connections using the instructions on page 17.
6. Use the IR/Serial (TX) terminals to wire IR or serial device connections using the instructions on page 18.
7. Use the Digital I/O terminals to wire digital Input/Output device connections using the instructions on page 20.
8. Use the RS-232 terminals to wire RS-232 serial device connections using the instructions on page 22.
9. Use the DB-9 ports to wire RS-232/422/485 serial device connections using the instructions on page 23.
10. Connect TCP LAN based devices to the same network as the VK2100 and use the instructions on page 24.
11. Plug the power cord supplied with the package into the VK2100's 3-prong AC socket and then into an AC power source.

# Installation Diagram

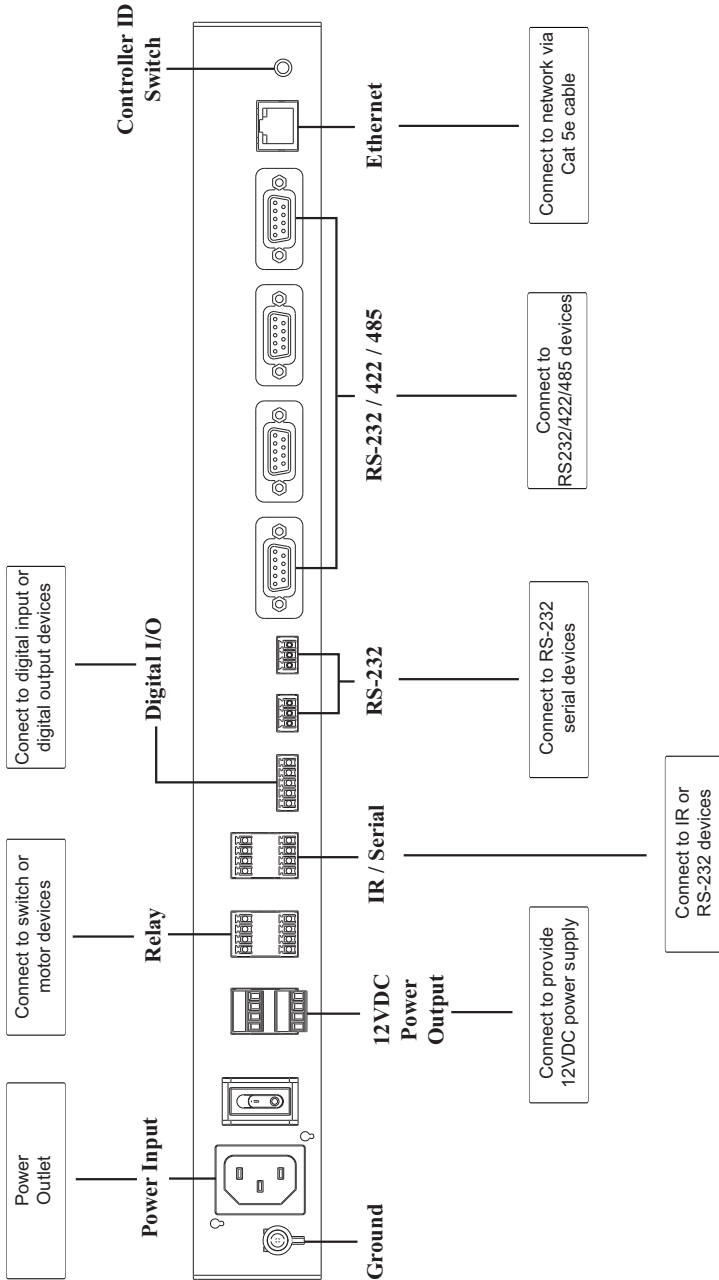

## 12VDC Power Output

Four ports provide 12VDC of power with a total of 24 watts. The output can power four independent hardware devices, four loops for connected relay devices, or four digital output devices as shown in the diagrams on the next 3 pages. If the combined current of the ports exceeds 2A, the DC Power Overload LED lights orange and the ports are turned off. The power will return to the four ports when the total current drops below 2A. After the overload resets it may take up to 30 seconds for power to return to the ports.

## Independent Power Supply

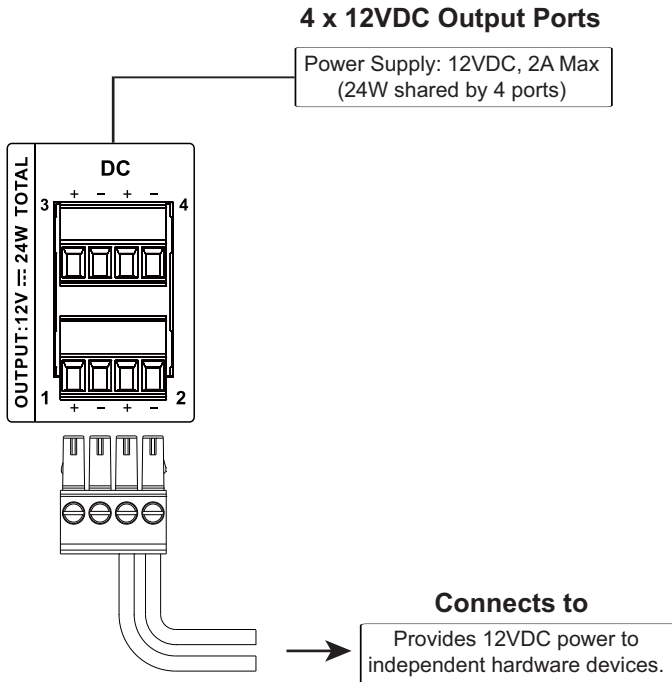

## Relay Power Supply

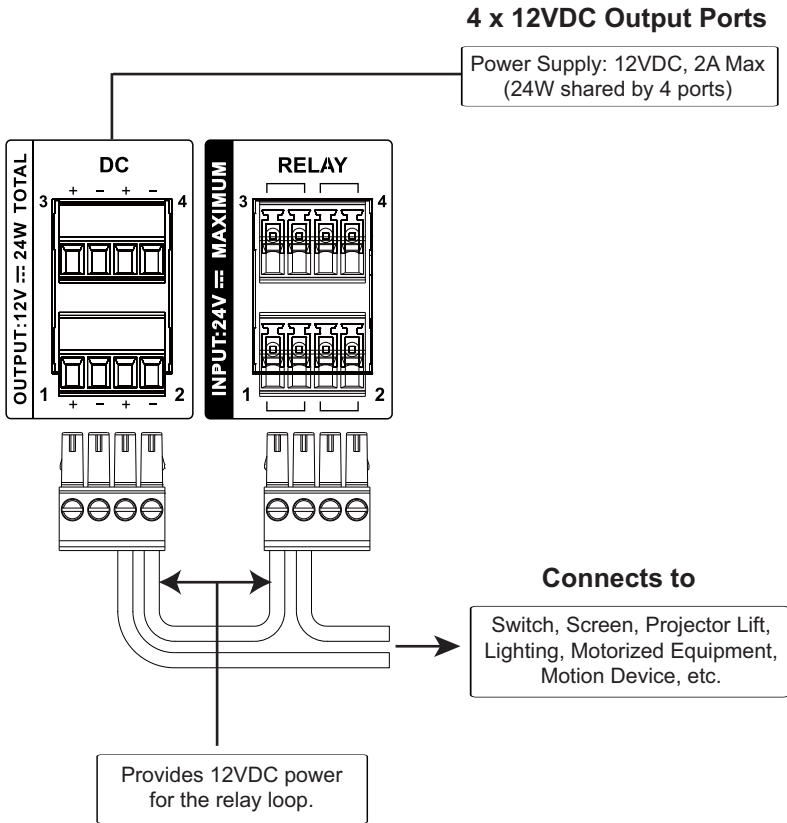





## Digital Output Dual Power Supply

### 4 x 12VDC Output Ports

Power Supply: 12VDC, 2A Max  
(24W shared by 4 ports)

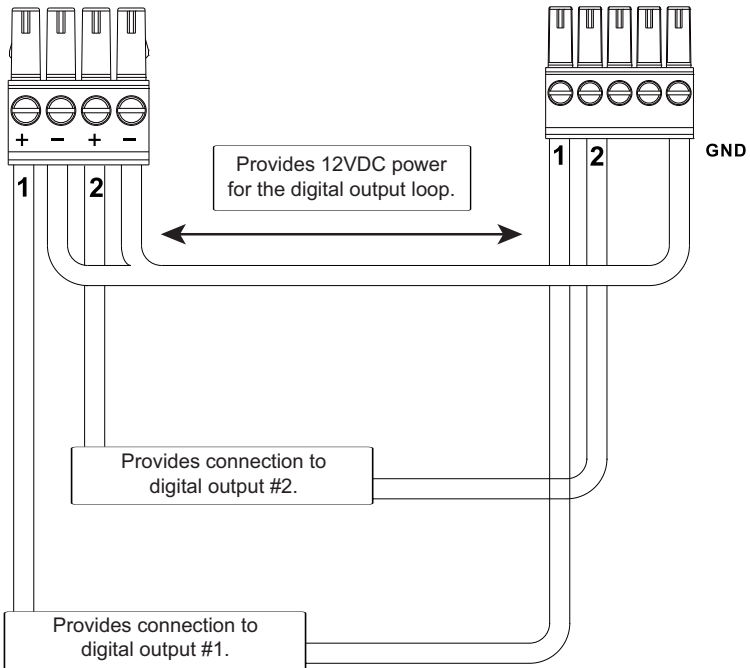
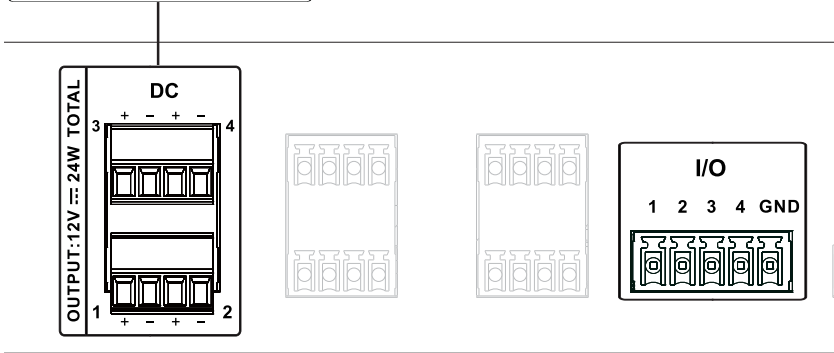

## Relay

These four Relay channels provide connections to control hardware devices such as electric screens, projector lifts and other motorized equipment. Each relay is normally open by default.

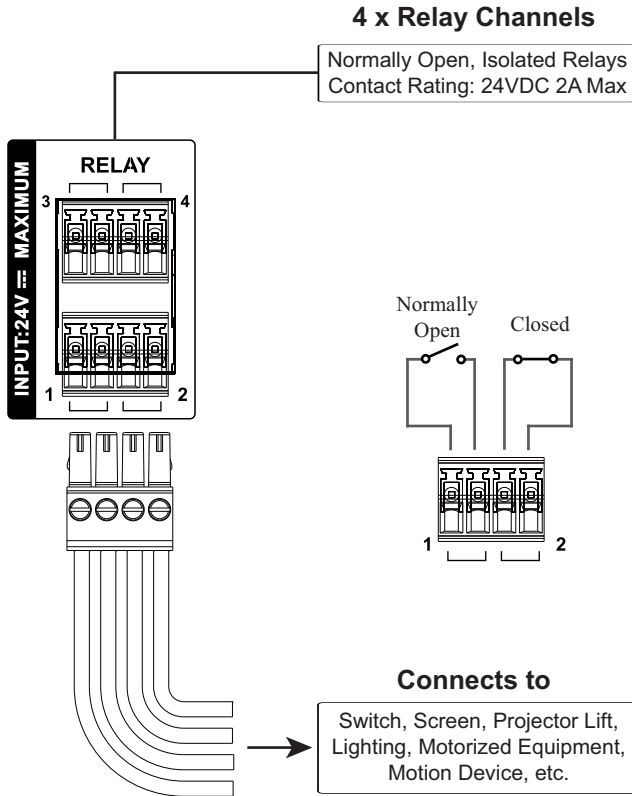

## IR / Serial

These four ports can be configured to connect IR and RS-232 devices. By default the ports are set to transmit IR signals. Use the ATEN Configurator software to configure the ports for RS-232 signals.

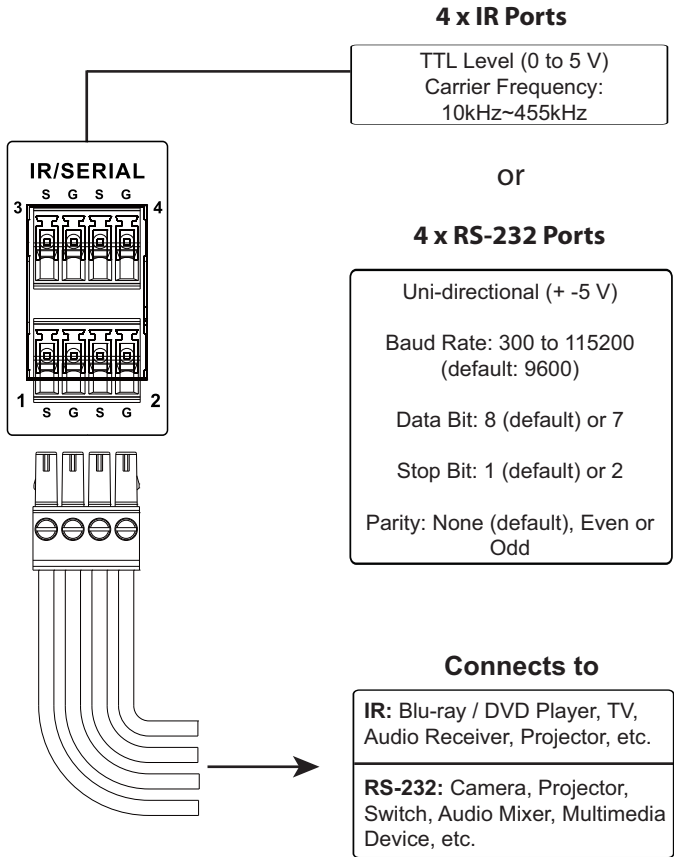

**IR Connection:** Connect a transmitter cable to the IR and Ground ports on the VK2100 and install the IR transmitter on or near the device's IR receiving port, as shown on page 19.

**Serial Connection:** Connect the device's receiver (RX) and ground ports to the Serial (TX) and Ground ports on the VK2100. Next configure the same serial port setting on the VK2100 and serial device so that they can communicate.

## One IR Transmitter

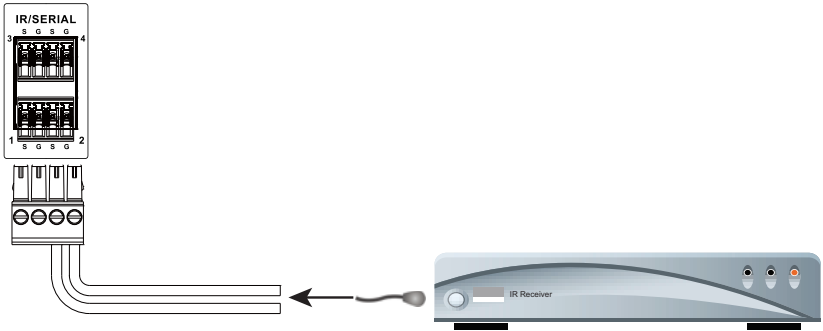

## Two IR Transmitters

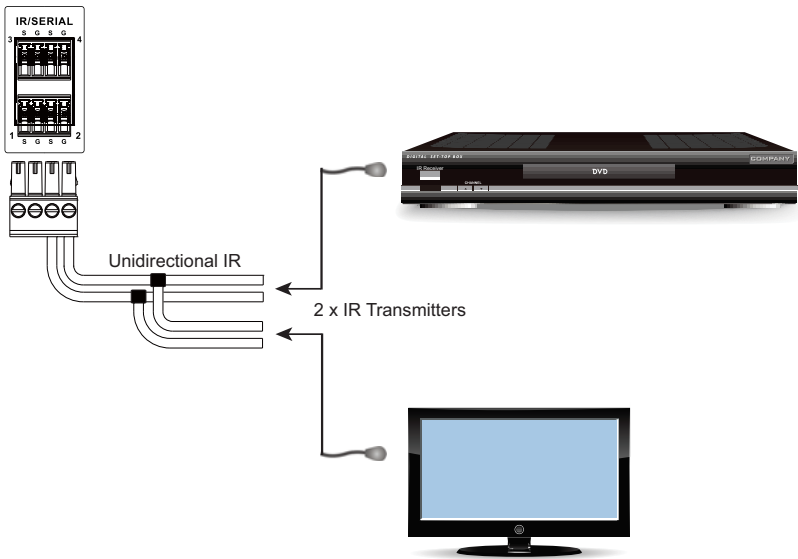

## Digital I/O

These four channels can be used to connect Digital Input or Digital Output hardware devices such as switches, sensors, LEDs and relays. Each channel can be configured as either an Input (VDC), Input (Dry Contact) or Output channel.

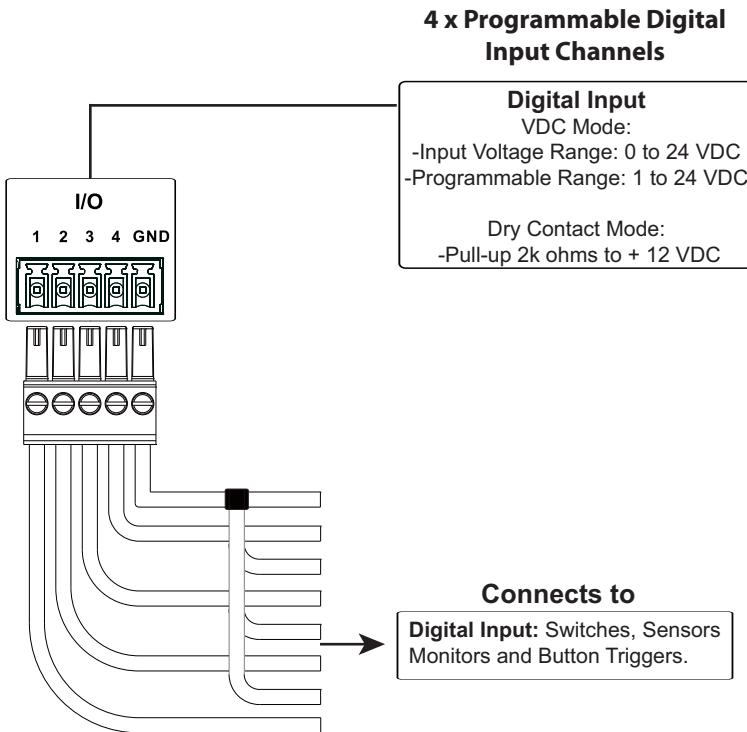

### Digital Input (Dry Contact):

Digital inputs are hardware devices (switches, sensors, monitors) with two circuit signals – open and closed. These two signals provide indicators from sensors or switches of an event. An event can be the on/off power, dry contact, sensor or switch status from a device. This information is used to trigger events and functions through the VK2100.

### Digital Input (VDC):

Digital input 12VDC hardware devices (temperature, current and monitor sensors) provide voltage signals between 1 and 24. A digital input port detects if a voltage is above/below a specific threshold (1 to 24). If the voltage coming from a hardware device is higher than the set value, the VK2100 will detect the digital input as high. If the voltage coming from a hardware device

is lower than the set value, the VK2100 will detect the digital input as low. This information is used to trigger events and functions through the VK2100.

### Digital Output:

Digital output channels provide non-powered dry contact (open and closed) circuit control of hardware devices such as electric screens, projector lifts and other motorized equipment. Devices connected to the Digital Output port must be connected through a **Relay Module**, as shown below.

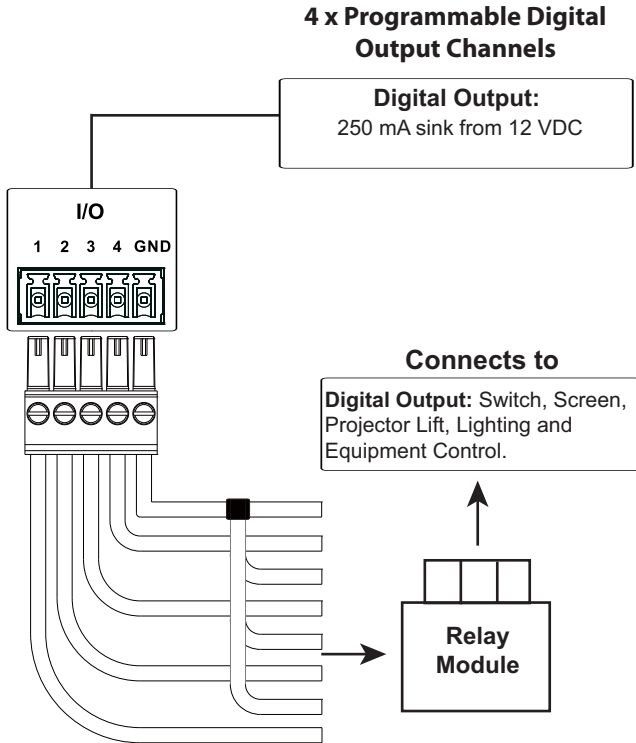

## **RS-232**

These two bi-directional RS-232 ports provide serial control of hardware devices (projectors, matrix switches, etc.) and receive status messages from the connected devices. For bi-directional RS-232 control, the transmit, receive and ground pins must be wired on both the VK2100 and hardware device. Each hardware device requires different wiring. Please consult each hardware device's manual for details.

### **2 x Bi-directional RS-232 Ports**

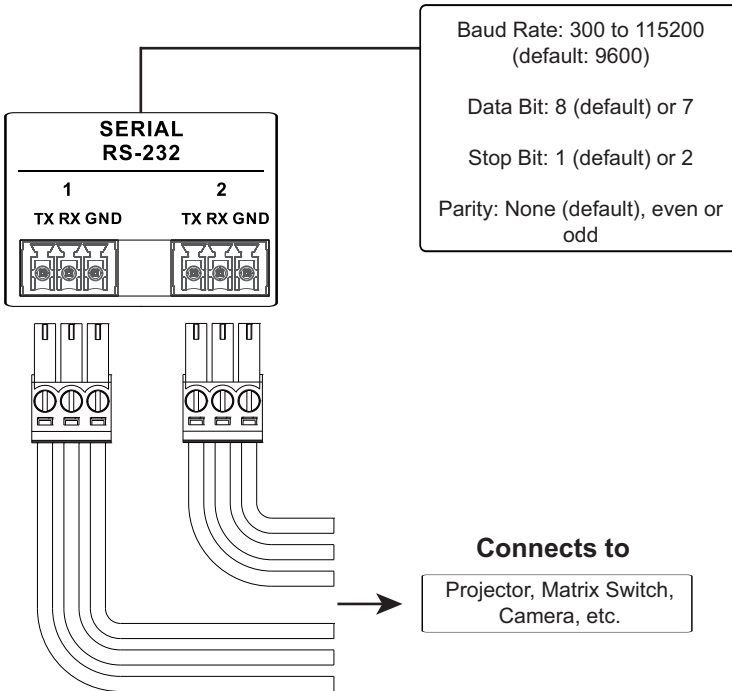



## RS-232 / 422 / 485

These four bi-directional ports provide serial control of hardware devices (projectors, switches, etc.) with programmable pin assignments and receive status messages from the connected devices.

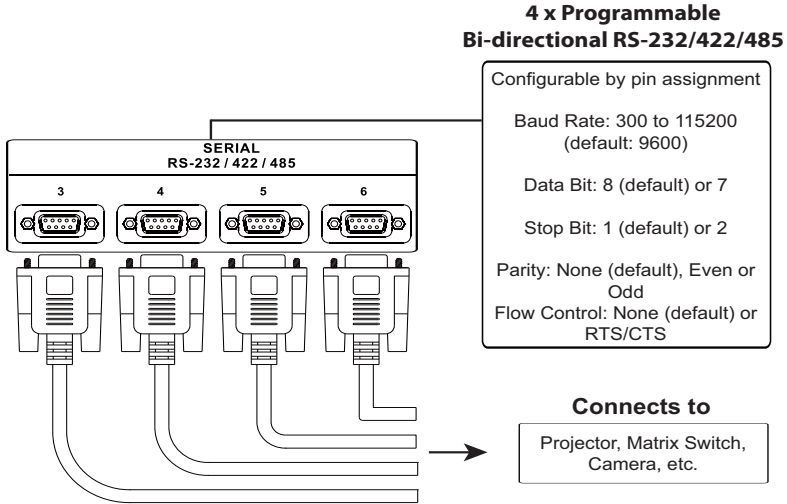

### Pin Assignments

RS-232	RS-422	RS-485
Pin2: RX	Pin1: RX-	Pin3: D+
Pin3: TX	Pin2: RX+	Pin4: D-
Pin5: GND	Pin3: TX+	
Pin7: RTS	Pin4: TX-	
Pin8: CTS	Pin5: GND	

## Ethernet

The RJ-45 port provides an Ethernet connection for GUI access (page 27) and the ability to add up to 25 LAN devices (page 47) per controller, as shown below.

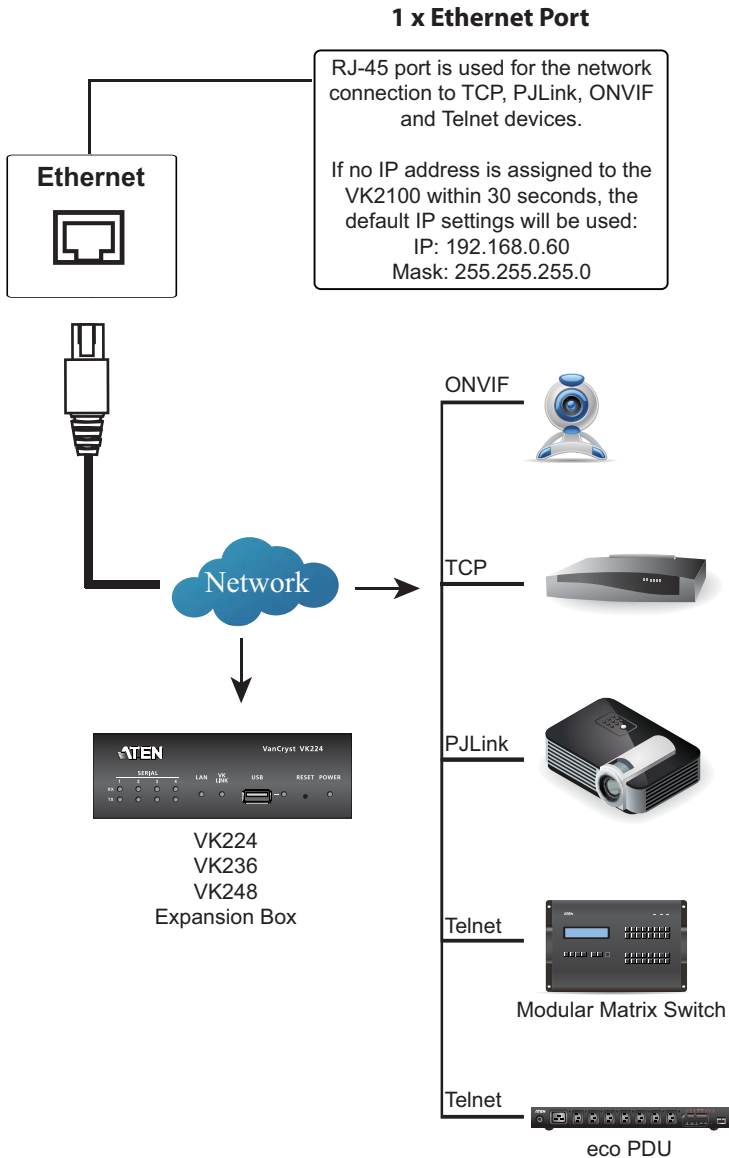

## Expansion Box

ATEN Expansion Boxes (sold separately) provide additional ports for a flexible expansion of the ATEN Control System. This allows you to add and control additional devices in an environment where more devices are required. With the advantage of an Ethernet-based connection, the expansion boxes are easily connected to the VK2100 Control Box via a LAN connection from a variety of locations across a network. The diagram below provides an example of the VK224 4-Port Serial Expansion Box setup.

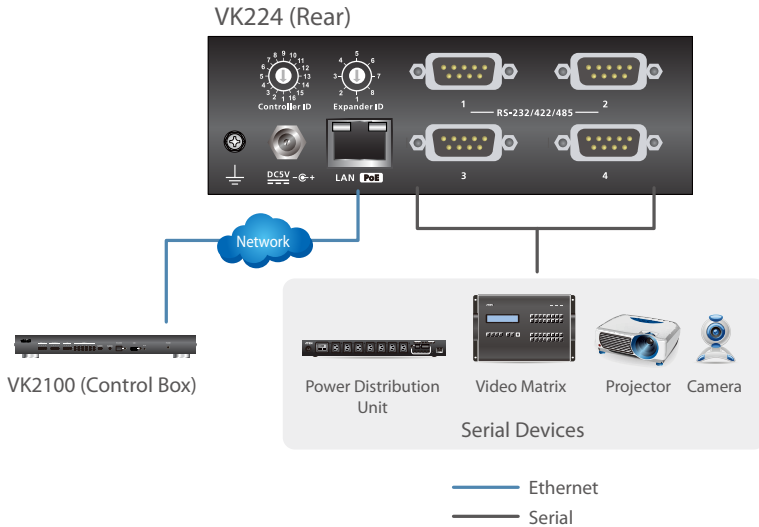

To add and configure ATEN Expansion Boxes: see *Select Device & Configuration*, page 47 and *Expander*, page 49.

## ATEN Expansion Boxes

Model	Description
VK224	4-Port Serial Expansion Box
VK236	6-Port IR/Serial Expansion Box
VK248	8-Channel Relay Expansion Box

This Page Intentionally Left Blank

# Chapter 3

## Browser Operation

### Overview

---

The VK2100 can be configured over a standard TCP/IP connection via its built-in Graphical User Interface (GUI). Because it can be accessed from anywhere over a network or the Internet, operators can easily log in via a web browser. The web interface can be used to upload licenses, set the access key, enable monitors and update the firmware.

### Logging In

---

To access the GUI, type the IP address of the controller into the address bar of any browser. If a Security Alert dialog box appears, accept the certificate – it can be trusted. The Welcome screen appears:

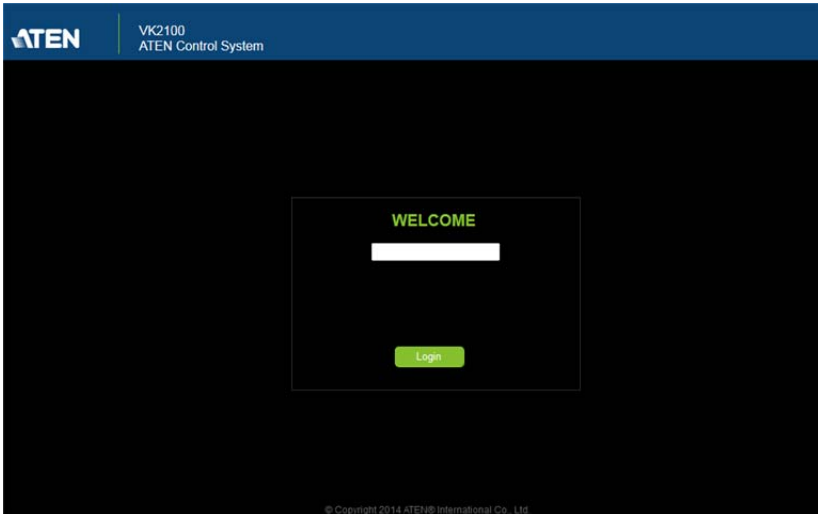

- ◆ The default IP address is **http://192.168.0.60**
- ◆ The default password is: **password**
- ◆ Enter the password, then click **Login**.
- ◆ Only one user can log in at a time.

## Dashboard

The *Dashboard* appears when you successfully log in to the VK2100. The Dashboard gives a quick view of each setting and provides a link to each page. Click **Manage** to configure the settings.

**ATEN VK2100 ATEN Controller**

**VK2100 Information**

**General** Manage

IP Address	10.3.41.116
MAC Address	00:10:74:b2:01:13
Date & Time	2015/09/11 20:25:45
FW Version	V9.2.113.007

**Licenses** Manage

In Use	1
Not In Use	1
Total	2

**Storage**

Percentage Available: 99.79%

Space Used	514 KB
Space Available	251,110 KB
Total Space	251,624 KB

**Existing Viewer** Manage

	All Rooms
	Viewer1
	Room-1
	Viewer3

**Access Key** Manage

Viewer Access Key Setting

**Monitor** Manage

The top bar provides two options:



Click to enter the **Settings** page.



Click to **Logout** of the web session.

## Settings

The *Settings* page provides six tabs. Each tab provides options to configure the controller. The page is divided into two parts, the **Interactive Display Panel** which is used to configure the options and the **Top Bar** which provides icons to exit the settings page and log out of the web session.

The Settings page opens on the **General** tab, as shown below:

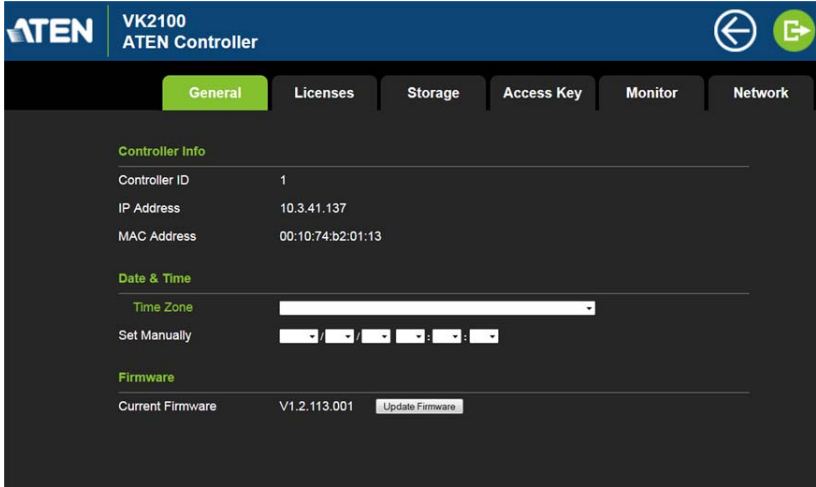

The *General* tab provides settings and information about the VK2100, as described in the table below.

Controller Info	<p>Provides network and identification information pertaining to the VK2100.</p> <ul style="list-style-type: none"> <li>◆ <b>Controller ID:</b> Displays the Controller ID # set on the rear of the VK2100.</li> <li>◆ <b>IP Address:</b> Provides the IP address of the VK2100.</li> <li>◆ <b>MAC Address:</b> Provides the hardware MAC address of the VK2100.</li> </ul>
Date & Time	<p>Provides two options to set the date and time:</p> <ul style="list-style-type: none"> <li>◆ <b>Time Zone:</b> To establish the time zone for the VK2100, use the drop-down menu and choose the city that most closely corresponds to where it is located.</li> <li>◆ <b>Set Manually:</b> Use the drop-down menus to manually set the Date (Year/Month/Day) and Time (Hour:Minute:Second).</li> </ul>

Firmware	<p>Displays the Current Firmware version and option to upgrade.</p> <p>Click <b>Update Firmware</b> to open the <i>Firmware Upgrade</i> window. Click <b>Browse</b> to select the firmware upgrade file.</p> <p>When <b>Check FW Version</b> is selected, the system will check the current firmware version against the one being used to upgrade the VK2100. If the device version is higher than the upgrade version a dialog box informs you and gives you the option to continue or cancel.</p> <p>After the file has been selected, click <b>Update</b> to start the firmware upgrade.</p>
----------	--

## Licenses

The *Licenses* tab allows you to upload and view license information.

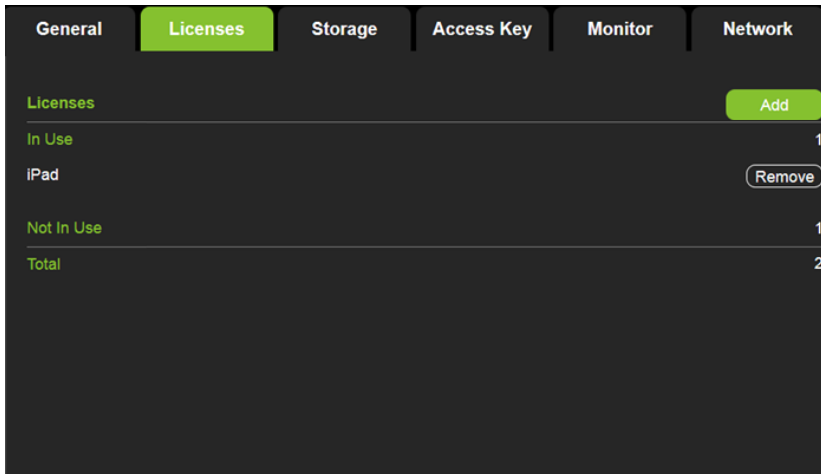

Licenses	<p>This section shows information about the licenses that are available on the controller. A license is used each time a mobile device connects to the VK2100 to control devices. <b>In Use</b> displays the number of licenses being used by mobile devices. <b>Not in Use</b> displays the number of licenses available for use.</p> <p><b>Total</b> shows the number of licenses purchased for use on the VK2100.</p>
Add	<p>Clicking <b>Add</b> opens the <i>Add License</i> window to upload new licenses to the VK2100. Click <b>Browse</b> to locate the license file and Add to upload the license(s).</p>
Remove	<p>When a device is accessing the Controller you can click the <b>Remove</b> button to disconnect the session.</p>



## Capacity

The *Capacity* tab displays information about the space available for storing viewer profiles on the controller.

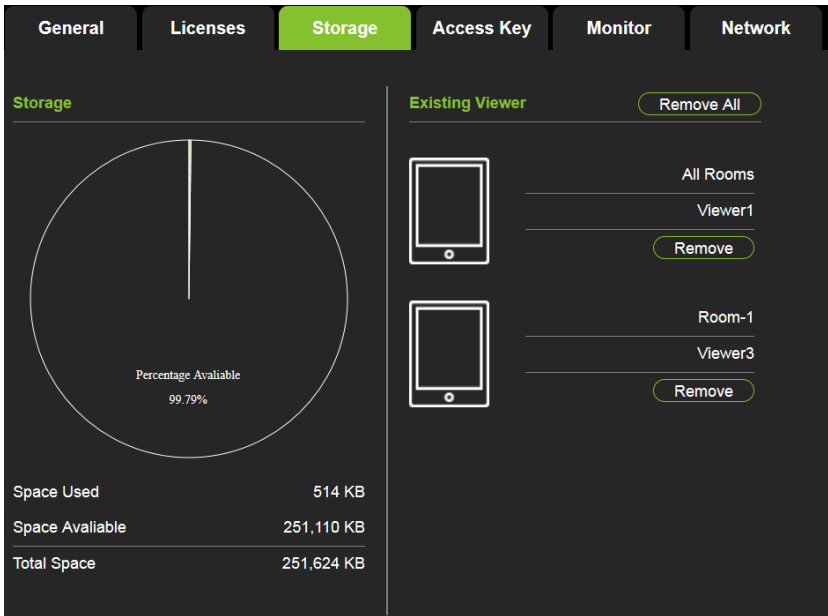

Storage	<p>This section shows a graph displaying the percentage of space available on the controller to upload viewer profiles, as well as:</p> <ul style="list-style-type: none"> <li>◆ <b>Space Used:</b> The amount of space currently being used to store viewer profiles uploaded to the controller.</li> <li>◆ <b>Space Available:</b> The amount of space currently available to store viewer profiles on the controller.</li> <li>◆ <b>Total Space:</b> The total amount of space available to store viewer profiles on the controller.</li> </ul>
Existing Viewer	<p>This section lists all the viewer profiles that are currently stored on the controller with their name and assigned room. Click <b>Remove</b> to delete a single viewer profile or <b>Remove All</b> to delete all viewer profiles from the controller.</p>

## Access Key

The *Access Key* tab allows you to manage the password that is used to upload/download viewer files to the controller and from a mobile device.

Show on dashboard	Check this box to show the Access Key settings on the Dashboard.
Current Access Key	Enter the password required to upload/download viewer profiles so that you can create a new access key.
New Access Key	Enter the current password in the <i>Current Access key</i> box and then use the <i>New Access Key</i> box to enter a new password, finally use the <i>Confirm Access Key</i> box to re-enter the new password.
Enable Viewer Access Key	Check this box to require a password when uploading/downloading viewer profiles to the controller and from a mobile device.
Save	Click to save changes to the access key settings.

## Monitor

The *Monitor* tab allows you to view and enable the monitors that have been configured for Flags and digital input devices in the VK6000 software. Check the **Show on dashboard** box to show the *Monitor* settings on the Dashboard. Click the slide bar next to the monitor you want to enable or use the drop-down menu to select **All On** or **All Off**.

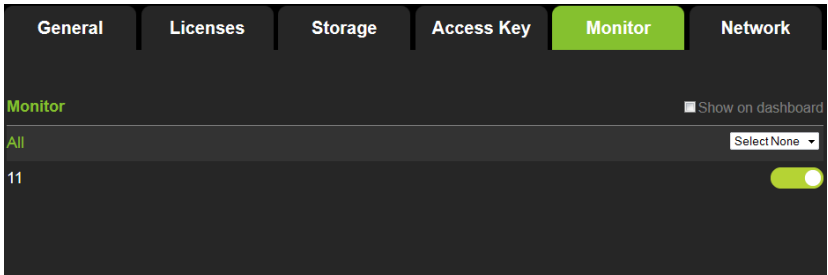

For more information about creating monitors, see *Advanced Editor*, page 80.

## Network

The *Network* tab allows you to view and configure the VK2100's network settings. Select **Manually** to set a static *IP Address*, *Subnet Mask* and *Default Gateway*, or **Use DHCP** to have the server assign an IP address to the VK2100.

The screenshot displays the Network configuration page with the following elements:

- Tabs:** General, Licenses, Storage, Access Key, Monitor, and Network (highlighted in green).
- Section Header:** Network
- Get IP Address:**
  - Manually
  - Use DHCP
- IP Address:** 10 . 3 . 41 . 128
- Subnet Mask:** 255 . 255 . 255 . 0
- Default Gateway:** 10 . 3 . 41 . 254
- Buttons:** Save (green), Cancel (white)

# Chapter 4

## Software Installation

### Overview

---

The ATEN Configurator software (VK6000) is a GUI-based management tool that helps you setup and configure the hardware and controls for the ATEN Control System App. To install the ATEN Configurator software, use the CD that was provided with your package and follow the instructions below.

### Configurator Software

---

#### Installation

To install the ATEN Configurator software, do the following:

1. Place the CD that came with your package into the CD-ROM drive on your computer.
2. Double-click the *ATEN Configurator.x.xxx.exe* file to run the setup and the *Choose Setup Language* screen appears. Select the language and click **Next**.

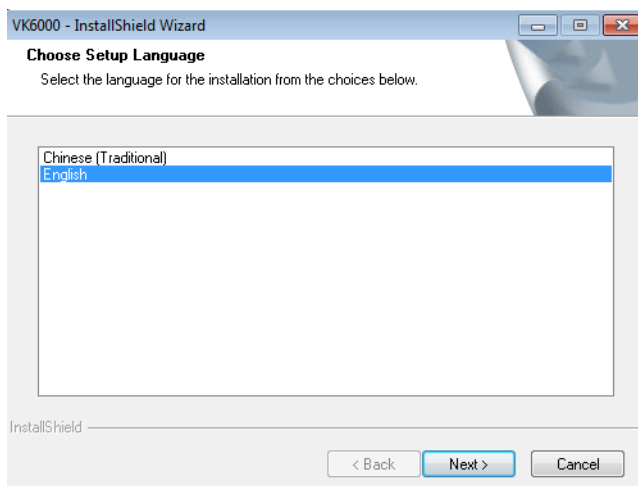

3. When the *Welcome* screen appears, click **Next**.

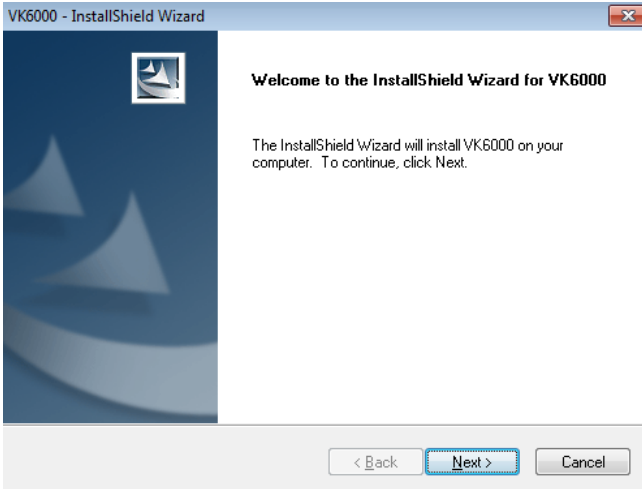

4. The *License Agreement* appears:

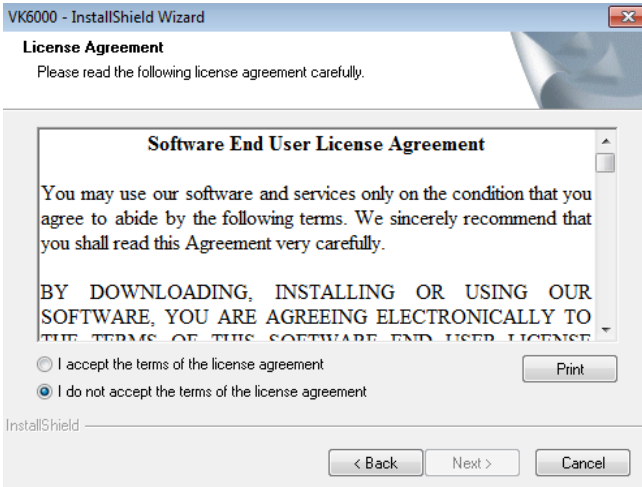

If you agree with the License Agreement, select *I accept the terms of the license agreement*, and click **Next**.

Click **Print** to print the *Software End User License Agreement*.

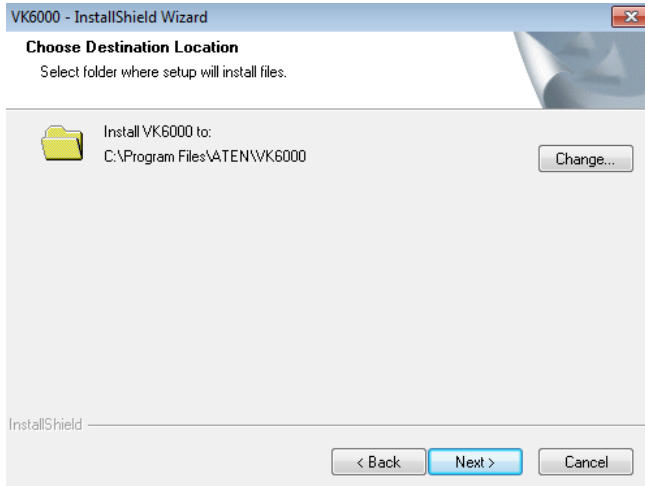
5. The *Choose Destination Location* screen appears:

Click **Change** to choose a location where you would like to install the program, or use the default location and click **Next**.

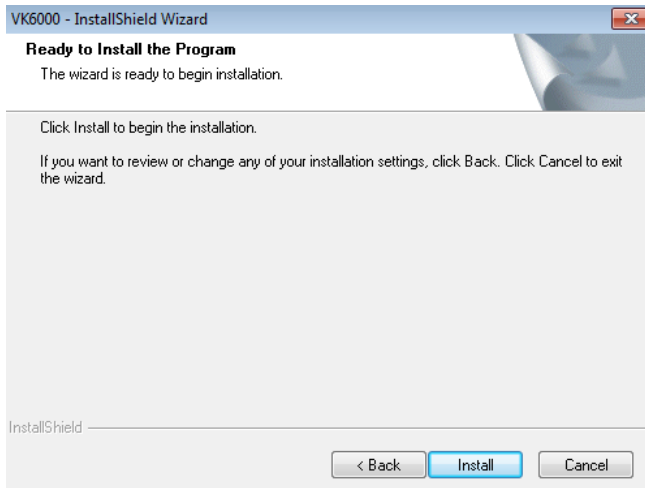
6. The *Ready to Install the Program* screen appears:

Click **Install** to begin the installation.

7. The *Setup Status* screen appears with the progress bar:

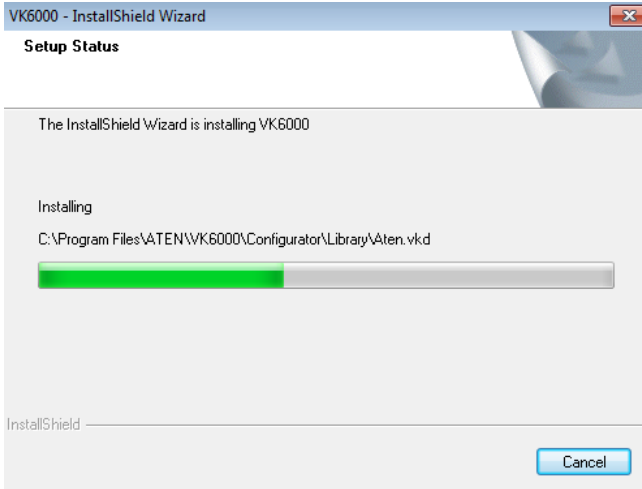

8. When the process is done, the *InstallShield Wizard Complete* screen appears:

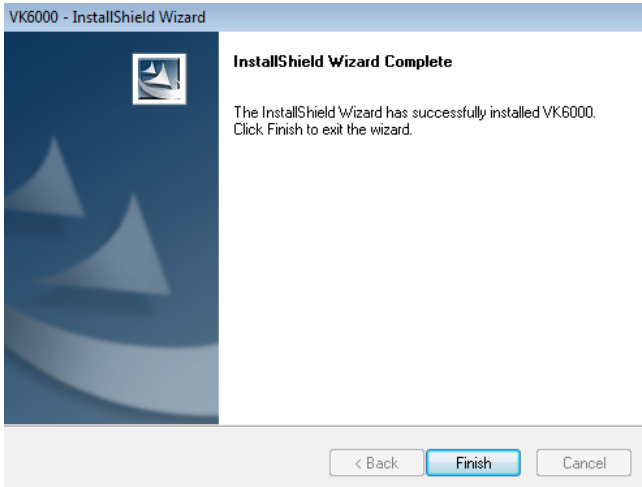

Click **Finish**.



# Chapter 5

## ATEN Configurator (VK6000)

### Overview

---

The ATEN Configurator software provides four easy steps to setup the hardware and create an interface with controls for each device. After you connect hardware to the VK2100, use the software to start a project to configure each of the controller ports, then design a user interface for a mobile device and finally upload the information to the controller (VK2100).

### Preface

---

The ATEN Configurator software guides you through setup in four easy steps. Use **Project Information** to enter details about the project; **Select Device & Configuration** to configure controller ports according to the connected hardware; **Create Viewer & Design** to design a user interface and configure the buttons that control each device; and **Search & Upload** to upload the project to the VK2100 controller.

The **Project Bar** in the ATEN Configurator software provides a link to each of the four steps that are discussed in this chapter.

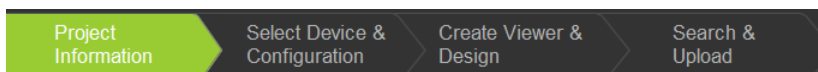

- ◆ Project Information, *page 46*
- ◆ Select Device & Configuration, *page 47*
- ◆ Create Viewer & Design, *page 55*
- ◆ Search & Upload, *page 90*

## Main Page

Double-click the **Configurator.exe** shortcut to open the ATEN Configurator software. The *Project Information* page appears:

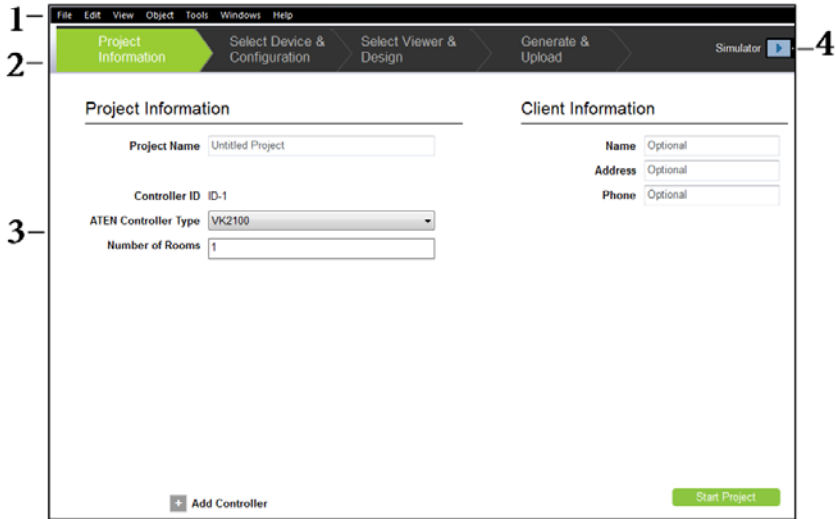

1	Menu bar	The <i>Menu Bar</i> contains categories with options that pertain to different sections of the software. Menu bar items are listed on page 41.
2	Project Bar	The <i>Project Bar</i> contains four tabs. Each tab relates to a step required to setup the VK2100. Each step can be selected by clicking on the bar. Each step is discussed, starting on page 46.
3	Interactive Display Panel	This is the main work area. The page that appears here reflects the project tab that is selected.
4	Simulator	The simulator button is used to test a viewer's interface after it has been created in <i>Create Viewer &amp; Design</i> . The simulator allows you to tryout the interface as it would work on a mobile device but without actually controlling devices. Use the mouse to click through the page links.

**Note:** To install the ATEN Configurator software, see *Software Installation*, page 35.

## Menu Bar

---

Use the *Menu Bar* to select options in each project tab. The table below provides a description of each menu item.

Menu	Sub-Menu	Description
File	New Project	Select to create a new project.
	Open Project	Select to browse and open a previously saved project.
	Close	Closes the current project and returns to the Project Information tab.
	Save	Select to save changes to the current project.
	Save as	Use this option to save the project as a different name.
	Export Viewer to USB	Exports the viewer(s) and access key to a USB drive. After exporting the data onto the USB drive, plug it into the controller's USB port to upload the viewer files and access key. These files can only be read by the controller and are not project files that can be opened by the ATEN Configurator software.
	Project Report	Click to save a PDF file that contains detailed information about each part of the current project.
	Exit	Select to close the project and exit.

Menu	Sub-Menu	Description
Edit	Undo	Select to undo a change when editing a viewer page in <i>Create &amp; Design Viewer</i> .
	Redo	Select to redo a change when editing a viewer page in <i>Create &amp; Design Viewer</i> .
	Cut/Copy/Paste	Select to cut, copy or paste text and objects when editing a viewer page in <i>Create &amp; Design Viewer</i> . When used to copy and paste a button, both the <i>General</i> and <i>Action</i> properties are copied (see page 65).
	Paste Graphic Only	Select to paste a button's image but not its <i>Action</i> properties in <i>Create &amp; Design Viewer</i> .
	Delete	Select to delete highlighted text and images when editing a page in <i>Create &amp; Design Viewer</i> .
	Delete Action Only	Select to delete the <i>Action</i> properties of a button in <i>Create &amp; Design Viewer</i> .
	Select All / Deselect All	Use either option to select or deselect all objects when editing a viewer page in <i>Create &amp; Design Viewer</i> .
	Preferences	Display Language
SSH Destination		Click to choose the location of the executable for the SSH Client software. To execute the program, go to the menu bar and select <i>Tools</i> → <i>SSH Client</i> .
Interface		Check a box to enable the feature described below: <ul style="list-style-type: none"> <li>◆ <b>Show Welcome Page:</b> displays the Welcome screen when the ATEN Configurator software opens.</li> <li>◆ <b>Show Upload Tip Screen:</b> displays a screen reminding you to set the controller ID before uploading profiles in <i>Search &amp; Upload</i>.</li> <li>◆ <b>Auto Page Creation:</b> automatically creates a viewer page in <i>Create Viewer &amp; Design</i>, for every hardware device that is configured in <i>Select Device &amp; Configuration</i>.</li> <li>◆ <b>Show Password:</b> displays the characters entered for the password in <b>Edit Access Key</b> from <i>Search &amp; Upload</i>.</li> </ul>

Menu	Sub-Menu	Description
View	These options are available from <i>Create Viewer &amp; Design</i> → <i>Edit Viewer</i> .	
	Zoom	Zooms the viewer page to 25%, 50%, 75%, 100%, 200% or Fit in Window. <b>Note:</b> A mouse wheel can be used to zoom the viewer page in or out.
	Project Information	Select to go to Project Information.
	Device Configuration	Select to go to Select Device & Configuration.
	Viewer Design	Select to go to Create Viewer & Design.
	Project Upload	Select to go to Search & Upload.
	Properties	Select to show/hide the Properties window when editing a viewer page.
	Align to Grid	Select to automatically align objects with the grid. This places objects in perfect alignment with the grid dots when they are moved. Use Show Grid to display the grid dots. When Align to Grid is not selected, objects can be placed anywhere on the page.
	Show Grid	Select to display the grid dots on the page. Use with the Align to Grid option to set objects in perfect alignment on the page.

Menu	Sub-Menu	Description	
Object	These options are available from <i>Create Viewer &amp; Design</i> → <i>Edit Viewer</i> .		
	Button	Select to add a button to the viewer page.	
	Text	Select to add a text box to the viewer page.	
	Image	Select to add an image to the viewer page.	
	Scroll View	Select to add a scroll box to the viewer page, then double-click it to add buttons. Use the box as a scroll window to easily access a list of buttons on the page.	
	Group	Group	Select multiple objects and use <b>Group</b> to lock them together. Objects in the group will move together as one.
		Ungroup	Select grouped objects and use <b>Ungroup</b> to unlock objects from the group.
	Order	Bring to Front	Moves an object to the top position when objects are layered.
		Send to Back	Moves an object to the bottom position when objects are layered.
		Bring Forward	Moves an object up one position when objects are layered.
		Send Backward	Moves an object down one position when objects are layered.
	Align	Left	Aligns two or more selected objects to the Left side of the object that is selected last.
		Center	Aligns two or more selected objects to the horizontal position of the object that is selected last.
		Right	Aligns two or more selected objects to the Right side of the object that is selected last.
		Top	Aligns two or more selected objects to the Top side of the object that is selected last.
		Middle	Aligns two or more selected objects to the vertical position of the object that is selected last.
Bottom		Aligns two or more selected objects to the Bottom side of the object that is selected last.	

Menu	Sub-Menu		Description
	Make Same Size	Width	Resizes two or more selected objects to the same width of the object that is selected last.
		Height	Resizes two or more selected objects to the same height of the object that is selected last.
		Both	Resizes two or more selected objects to the same width and height of the object that is selected last.
	Space Evenly	Across Page Width	Spaces two or more selected objects evenly across the width of the page.
		Across Page Height	Spaces two or more selected objects evenly across the height of the page.
		Between Objects Horizontally	Adjusts the horizontal space between three or more selected objects to the average distance between each of the selected objects.
		Between Objects Vertically	Adjusts the vertical space between three or more selected objects to the average distance between each of the selected objects.
Tools	Database Generator		Opens the ATEN Database Generator which is used to manually add and configure hardware devices. This is where you can create custom devices to add to <i>My Device Library</i> . See <i>ATEN Database Generator</i> , page 93, for details.
	Simulator		The simulator is used to test a viewer's interface after it has been created in <i>Create Viewer &amp; Design</i> . The simulator allows you to tryout the interface as it would work on a mobile device but without actually controlling devices. Use the mouse to click through the page links.
	SSH Client		This runs the SSH Client software selected under <i>Edit</i> → <i>Preferences</i> → <i>SSH Destination</i> . The SSH Client is used to communicate with the controller.
Windows	New Page		Click to create a new viewer page or select a page to open in <i>Create Viewer &amp; Design</i> .
Help	About		Provides the firmware version and support information for the Configurator software.

## Project Information

The *Project Information* tab allows you to enter details about the installation to start the project. Enter the information using the table below as a guide.

The screenshot shows a software interface with a navigation bar at the top containing four tabs: 'Project Information' (highlighted in green), 'Select Device & Configuration', 'Create Viewer & Design', and 'Search & Upload'. Below the navigation bar, there are two main sections: 'Project Information' and 'Client Information'. The 'Project Information' section includes a text input for 'Project Name' (containing 'Untitled Project'), a dropdown for 'Controller ID' (set to 'ID-1'), a dropdown for 'ATEN Controller Type' (set to 'VK2100'), and a text input for 'Number of Rooms' (set to '1'). The 'Client Information' section includes three text inputs for 'Name', 'Address', and 'Phone', each with 'Optional' written below it. At the bottom of the interface, there are two buttons: 'Add Controller' and 'Start Project'.

Project Name	Enter the name of the project you are setting up. You can create multiple projects but for most installations only one project is required.
Controller ID	Displays the Controller ID for the controller in the project. Use the Controller ID in the project to set the <b>Controller ID Switch</b> on the rear of the VK2100. This tells the software which VK2100 to upload the device configuration and viewer profile information to.
ATEN Controller Type	Select the controller model you are installing.
Number of Rooms	Enter the number of rooms the VK2100 will control. When a viewer profile is created in <i>Create Viewer &amp; Design</i> , you need to select the <i>Accessible Room</i> which will associate the profile to a controller via the room number. This link allows the software to know which controller to upload the viewer profile to.
Name	Enter the client name associated with the project.
Address	Enter the client address associated with the project.
Phone	Enter the client phone number associated with the project.
Add Controller	Click to add controllers* to the project. The number of controllers added should equal the number of VK2100 units being installed. A project can have up to 16 controllers. *A controller is the software's link to the VK2100 being installed.
Remove Controller	Click to delete a controller from the project.
Start Project	Click to begin configuring hardware devices. The <i>Select Device &amp; Configuration</i> tab will open.



## Select Device & Configuration

The *Select Device & Configuration* tab is used to configure VK2100 ports according to the connected hardware device. To add a device, select a port under **Device Configuration** and use the **Device Library** on the right sidebar to find the hardware. If a device is not in the Device Library, use the *Database Generator* to create a custom device (see page 93).

The screenshot shows the ATEN Configurator software interface. The main window is titled 'Breit's Room' and displays the 'Device Configuration' tab for a 'VK2100-ID01' controller. The interface is divided into several sections:

- Left Sidebar:** A tree view showing the hierarchy of controllers and rooms. Under 'Breit's Room', there are two rooms: 'Room-1' and 'Room-2'. 'Room-1' contains several devices including VM0404H-0, VM000T-0, SPC32H16710V0014, TV1515-0, DENON 334-0, VM000H, VM000H-1, P.JLNK, TELNET, ONVF, TCP Device, and TELNET-A. 'Room-2' contains DV-CP701-0.
- Main Configuration Table:** A table with columns for 'Type', 'Device', 'Mode', and 'Room'. It lists various ports and their configurations:
 

Type	Device	Mode	Room
Serial 1	VM000H-1	RS232	Room-1
Serial 2	VM0404H-0	RS232	Room-1
Serial 3	VM000T-0	RS232	Room-1
Serial 4	VM000H	RS232	Room-1
Serial 5	None	RS232	Room-1
Serial 6	None	RS232	Room-1
I/O 1	None	Input (VDC)	Room-1
I/O 2	None	Input (VDC)	Room-1
I/O 3	None	Output	Room-1
I/O 4	None	Output	Room-1
IR 1	SPC32H16710V0014189-0	IR	Room-1
IR 2	TV1515-0	IR	Room-1
IR 3	DV-CP701-0	IR	Room-2
IR 4	DENON 334-0	IR	Room-1
Relay 1	1		Room-1
Relay 2	None		Room-1
Relay 3	None		Room-1
Relay 4	None		Room-1
Ethernet 1	TELNET-A	TELNET	Room-1
Ethernet 2	P.JLNK	P.JLNK	Room-1
Ethernet 3	TELNET	TELNET	Room-1
Ethernet 4	ONVF	ONVF	Room-1
Ethernet 5	TCP Device	TCP	Room-1
- Properties Panel:** Located at the bottom, it shows details for the selected controller: Name: VK2100, Controller ID: ID01, Brand: Aten.

Device Configuration	This section lists the ports for each controller. Select a Controller, Expander or Room in the left sidebar to display the ports. Each port needs to be configured according to the hardware device connected to it (see page 48).
Left Sidebar	This section lists the Controllers, Expanders and Rooms. Use the sidebar to add a Controller, or Expanders and Rooms to a controller. When a port is configured with a device, the device appears listed below the room on the sidebar (see page 49).
Right Sidebar	This section provides the <b>Device Library</b> option which contains a database of hardware devices that is used to configure VK2100 ports.
Device Library	The <i>Device Library</i> is an extensive database of hardware devices that is used to configure VK2100 ports (see page 51).
Properties	This section displays information about the selected controller, port or room (see page 49).

## Device Configuration

The *Device Configuration* page lists the controller ports by type. Click a port to view its **Properties** (page 49). Double-click a port to open the **Device Library** and search for the hardware device to configure the port. Configure each port according to the hardware device connected to it.

Type	Device	Mode	Room
Serial 1	None	RS232	Room-1
Serial 2	None	RS232	Room-1
Serial 3	None	RS232	Room-1
Serial 4	None	RS232	Room-1
Serial 5	None	RS232	Room-1
Serial 6	None	RS232	Room-1
I/O 1	None	Output	Room-1
I/O 2	None	Output	Room-1
I/O 3	None	Output	Room-1
I/O 4	None	Output	Room-1
IR 1	None	IR	Room-1
IR 2	None	IR	Room-1
IR 3	None	IR	Room-1
IR 4	None	IR	Room-1
Relay 1	None		Room-1
Relay 2	None		Room-1
Relay 3	None		Room-1
Relay 4	None		Room-1
Ethernet 1	None		Room-1

Type	Lists the VK2100's port type and number.
Device	Lists the device name entered in the Properties.
Mode	Lists the port's communication mode. Click an arrow to select options: <ul style="list-style-type: none"> <li>◆ <b>Serial:</b> RS232, RS422, or RS485</li> <li>◆ <b>I/O:</b> Input (VDC), Input (Dry Contact) or Output</li> <li>◆ <b>IR:</b> IR or RS232</li> </ul>
Room	Lists the room selected for a device. The rooms available depend on the number of rooms added to the controller. No drop-down menu appears if there is only one room. Each controller must have at least one room. Select the room where the device is installed.
+ Add More Devices	RS422, RS485, LAN and IR ports can cascade additional devices that are connected to the first unit. IR ports can cascade 1 device, RS422 and RS485 ports can cascade up to 3 devices and LAN ports can cascade up to 19 devices.

## Left Sidebar

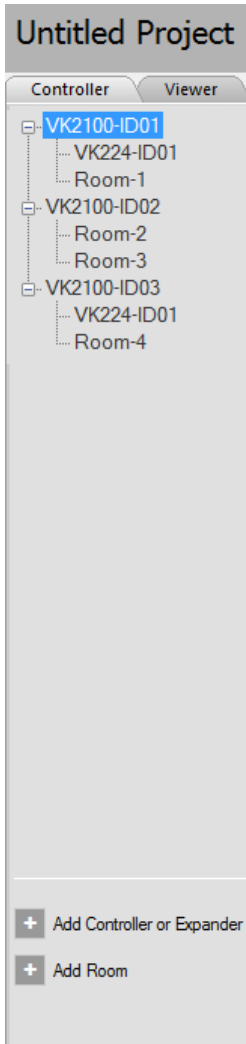

### Controller

The *Left Sidebar* provides a tree view of the controllers, expanders and rooms. Each controller represents a VK2100 with the room(s) it manages. Selecting a controller allows you to configure its ports. When a port is configured for a device, it appears listed under the Room.

Each controller must have one room. When installing multiple controllers in one room, add a room with the same name to each controller.

Each controller name ends with an ID number: VK2100-**ID01**. Use this number to set the **Controller ID Switch** on the rear of the VK2100. This links the controller in the software to the VK2100 being installed.

Right click a controller to **Add Room** or **Delete Controller**.

### Room

Rooms are associated with a controller and a viewer profile so that the information is uploaded to the correct VK2100 to control devices.

Right click a room to **Delete** or **Rename** the room.

Use the buttons at the bottom of the sidebar to **Add Controller or Expander**; or **Add Room**.

### Expander

ATEN Expansion Boxes connect over a network to add ports to the controller via its Ethernet port. Clicking **Add Controller or Expander** opens a window which allows you to select a device to add:



## **Right Sidebar**

The *Right Sidebar* provides the **Device Library**. Use the Device Library to configure a VK2100 port according to the hardware device connected to it. The Device Library provides an extensive database of hardware devices that can be double-clicked or drag and dropped into the **Device Configuration** page to configure the VK2100 ports. The Device Library is discussed on the next page.



## Device Library

The *Device Library* is a database of hardware devices that instantly configure VK2100 ports. Search the library for the device connected to a VK2100 port then add it to configure the port. For devices not in the library, use the **ATEN Database Generator** to create custom hardware (see page 93).

Click **Device Library** on the right sidebar or double-click a port from the *Device Configuration* page to open the device library.

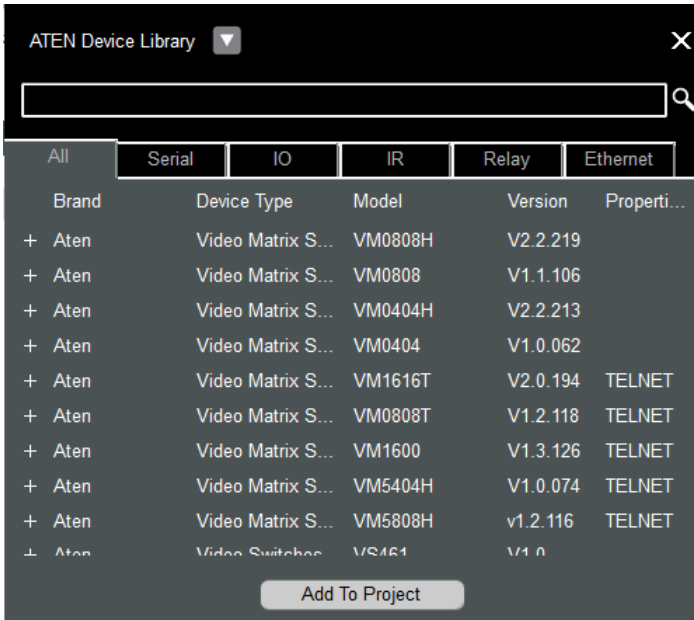

- ◆ Add a device by clicking **+**, **Add to Project** or by **drag & drop**.
- ◆ To search for a device type keywords into the box and click .
- ◆ Click tabs to filter by **All**, **Serial**, **I/O**, **IR**, **Relay** or **Ethernet**.
- ◆ Click headings to sort by **Brand**, **Device Type**, **Model** or **Version**.
- ◆ Use the drop-down menu to select:
  - ◆ **ATEN Device Library** – ATEN’s database of hardware devices.
  - ◆ **My Device Library** – Devices added in the Database Generator.
  - ◆ **Create Device** – Opens the *Database Generator* to create custom hardware devices for *My Device Library* (page 93).

## Properties

The *Properties* displays information about the selected device. The information available depends on the device or port selected. The table below describes information shown for all types, followed by sections for types that include additional options.

The screenshot shows a window titled "Properties" with a "Control Box" icon on the left. On the right, there are five input fields: "Name" (text box), "Device Type" (text box), "Brand" (text box), "Model" (text box), and "Version" (dropdown menu with a menu icon). An "Add Custom" button is located at the bottom right.

Name	Displays the device name and allows you to edit it.
Device Type	Displays the device of the selected device.
Brand	Displays the brand of the selected device.
Model	Displays the model of the selected device.
Version	Shows the firmware version selected for the device. Use the drop-down menu to select a different firmware version. Click the menu box next to the version number to open a PDF with the version history. The version history and different versions for a device can be manually added/updated via the Database Generator (see step 3 of <i>Edit / Add New Device</i> , page 97).
Add Custom	Enter a name for the device and click <b>Add Custom</b> to reserve a port for a new custom device.
Arrow Bar	Use the arrow bar at the top of the frame to open and close the properties window.

### ■ Serial

Provides drop-down menus to configure the **Baud Rate**, **Databit**, **Stopbit**, **Parity** and **Flow Control** settings. Configure these options to match the serial device settings.

The screenshot shows a configuration window with five dropdown menus: "Baud Rate" (9600), "Data Bit" (8), "Stop Bit" (1), "Parity" (None), and "Flow Control" (None). An "Add Custom" button is located at the bottom right.

## ■ I/O

Two drop-down menus appear for *Input (VDC)* ports: **Lower Threshold** and **Upper Threshold**. Set the thresholds according to the hardware device you are connecting and then configure a *Monitor* (see page 83).

The screenshot shows two dropdown menus. The first is labeled "Lower Threshold" and has the value "1" selected. The second is labeled "Upper Threshold" and has the value "24" selected.

## ■ Ethernet

These options allow you to configure the settings for a **PJLINK**, **TELNET**, **ONVIF** or **TCP** LAN device. Select the Protocol Type and then enter the IP Address, Port, Username and/or Password as required by the option you select. Each controller can add 20 LAN devices that connect through the VK2100's Ethernet port.

The screenshot shows a configuration form with the following fields:
 

- Protocol Type**: A dropdown menu with "PJLINK" selected.
- IP Address**: An empty text input field.
- Port**: A text input field containing the value "4352".
- Password**: An empty text input field.
- Add Custom**: A button located at the bottom right of the form.

Use the *Protocol Type* drop-down menu to select:

- ◆ **PJLINK** – allows control of data projectors over a network using the PJLink protocol. Enter the **IP Address**, **Port** and **Password** of the LAN projector or device used to control the projector.
- ◆ **TELNET** – allows control of a LAN device via telnet commands. Enter the **IP Address**, **Port**, **Username** and **Password** of the telnet controlled LAN device.
- ◆ **ONVIF** – allows use of the ONVIF protocol which allows video from devices to be controlled and displayed through the ATEN Control System App. Enter the **IP Address**, **Username** and **Password** of the ONVIF device you are adding.
- ◆ **TCP** – allows control of a TCP LAN device. Enter the **IP Address** and **Port** of the device you are adding.

### ■ Controller

When you select a controller from the left side bar, the properties provides a drop-down menu to set the Controller ID (ID01~ID16). See *Controller ID*, page 46, for details.

A screenshot of a configuration form for a controller. It contains three fields: 'Name' with the value 'VK2100', 'Controller ID' with a dropdown menu showing 'ID07', and 'Brand' with the value 'ATEN'.

### ■ Expander

When you select an expander (VK224, VK236, VK248) from the left side bar, the properties provides a drop-down menu to set the Expander ID (ID01~ID08) and the option to configure the IP Address.

A screenshot of a configuration form for an expander. It contains four fields: 'Name' with the value 'VK224', 'Expander ID' with a dropdown menu showing 'ID01', 'Brand' with the value 'Aten', and 'IP Address' with the value 'Optional'.

To add an expander, click **Add Controller or Expander** on the left sidebar, then use the arrow and select an ATEN Expansion Box to add. The expansion box and ports will be listed on the *Device Configuration* page, as shown below:

VK224-ID01				
Type	Device	Mode		Room
Serial 1	None	RS232	▼	Room-1
Serial 2	None	RS232	▼	Room-1
Serial 3	None	RS232	▼	Room-1
Serial 4	None	RS232	▼	Room-1



## Create Viewer & Design

The *Create Viewer & Design* tab is for creating the **Viewer** – the user interface that controls the devices from a mobile device. Create a viewer for each room that has hardware devices connected to a VK2100.

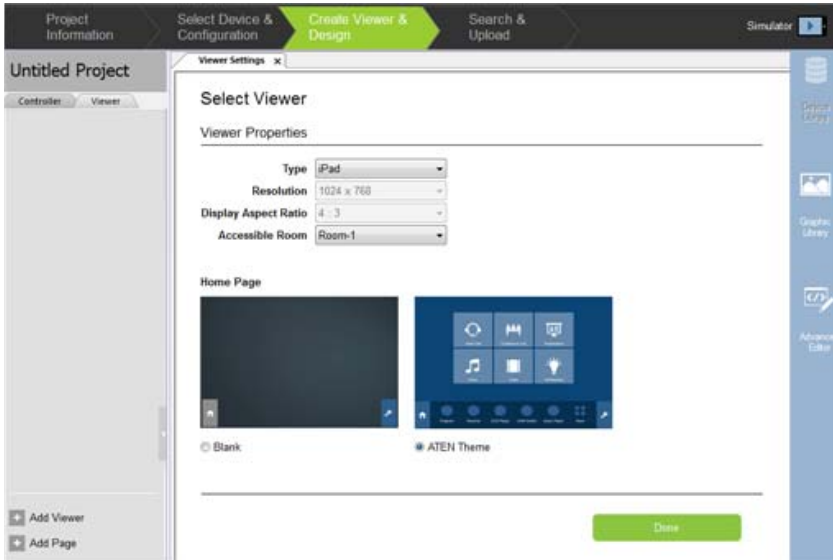

Viewer Settings	The Viewer Settings page appears if no viewer has been created so that you can set the Viewer Properties. The viewer properties must be set before you begin configuring the viewer's pages. When you are finished, click <b>Done</b> to begin designing the viewer pages. See <i>Select Viewer</i> , page 56, for details.
Left Sidebar	The left sidebar lists each viewer and its pages. The sidebar allows you to add viewers and pages. These options become available after clicking Done on the Viewer Settings page. See <i>Left Sidebar</i> , page 49, for details.
Right Sidebar	The right sidebar provides the <b>Graphic Library</b> (page 78) and <b>Advanced Editor</b> (page 80) options. See <i>Right Sidebar</i> , page 58, for details.
Viewer Properties	The Viewer Properties section allows you to set the basic settings for the viewer. See <i>Select Viewer</i> , page 56, for details.

## Select Viewer

The *Select Viewer* page sets the basic properties for each viewer that you create. The viewer is a user interface designed for a mobile device, with the pages and buttons to control each hardware device. Use the table below to select the viewer settings, then click **Done** to continue.

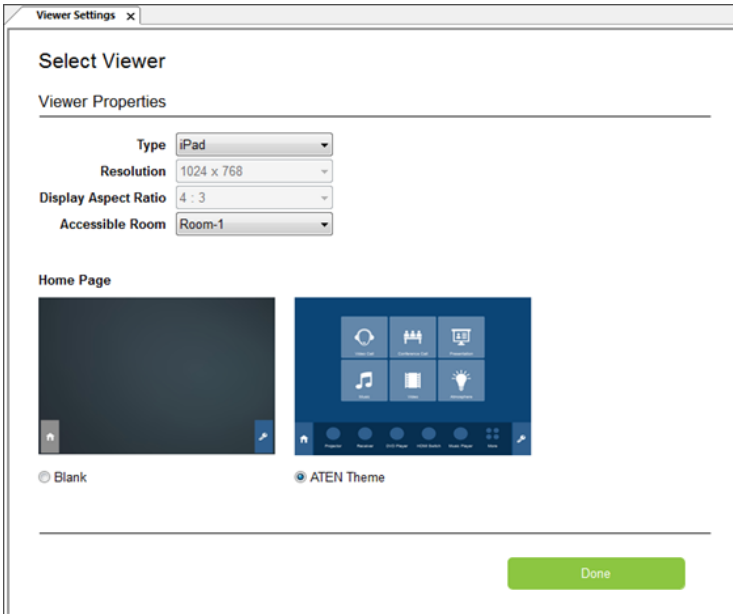

Viewer Properties	Displays the base settings that must be selected to create a viewer profile.
Type	Use this drop-down menu to select the mobile device being used to control hardware devices in a room. This sets the resolution for the viewer to fit on the mobile device screen. Choose a <b>Custom</b> device selection to configure the screen size with the <i>Resolution</i> drop-down menu below it.  <b>Note:</b> If you select <i>Custom Windows Device</i> – the Windows OS has a limitation for adding buttons to the viewer pages for Windows mobile devices. See <i>Windows OS Button Limitation</i> , page 63, for details.
Resolution	Use this drop-down menu to set a custom screen resolution for the mobile device being used to control hardware devices. This option becomes available when you select one of the <i>Custom</i> selections from the <b>Type</b> drop-down menu. The <b>Display Aspect Ratio</b> menu is only provided as a reference and can not be set.

---

Accessible Room	<p>Select the room that the viewer will control devices in. The viewer will only upload to a controller configured with the same <i>Room</i> name (see <i>Left Sidebar</i>, page 49).</p> <p>Select <b>All Rooms</b> to allow the viewer to control all rooms. Selecting <i>All Rooms</i> will upload the viewer profile to all controllers.</p> <p>The Accessible Room defines what <b>Devices</b> are available to configure new <b>Actions</b> in Button Properties (see page 66). Only <i>Devices</i> listed under the same <i>Room</i> (see page 49) as the viewer's Accessible Room, will be listed for use in Button Properties.</p>
Home Page	<p>Sets the layout for the Viewer's home page:</p> <ul style="list-style-type: none"><li>◆ <b>Blank</b>: Creates a custom home page that you design from scratch.</li><li>◆ <b>ATEN Theme</b>: Creates a home page with graphics. This theme provides a template that can be customized into your own home page design.</li></ul>
Done	<p>Click Done to edit the Viewer pages.</p>

---

## Left Sidebar

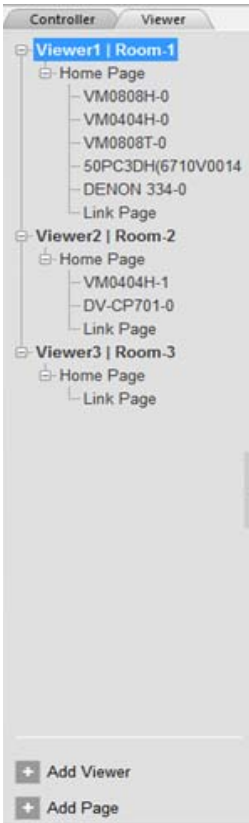

### Viewer

The *Left Sidebar* provides a tree view of the **Viewers** and **Pages**. Clicking a viewer opens the *Page Overview* which is a layout of the viewer's pages.

Right click a viewer to **Delete**, **Rename** or **Edit** the viewer.

Use **Add Viewer** at the bottom of the sidebar to create a new viewer.

### Pages

Each viewer lists the **Home Page**, **Link Page** and a **Device Page** for each device added from the Device Library.

Clicking a Home Page, Link Page or Device Page on the sidebar opens a new tab where the page can be edited.

Right click a page to **Delete** or **Rename** the page. The Home Page cannot be deleted.

Use **Add Page** at the bottom of the sidebar to add a page to the viewer.

## Right Sidebar

The *Right Sidebar* provides the **Graphic Library** and **Advanced Editor** options. The Graphic Library provides ready-to-use objects for designing viewer pages. The Advanced Editor provides **Macro**, **Monitor** and **Flag** options to configure the function of buttons. The Graphic Library is discussed on page 78 and the Advanced Editor on page 80.



## Page Overview

*Page Overview* shows each viewer page that controls the hardware devices from a mobile device. Hardware devices added from the *ATEN Library* will have control pages automatically created for them. Custom hardware that is created with the **Database Generator** will appear with default buttons generated according to the *Category* selected (page 97). Actions added manually to the Functions List need to have a button added manually.

Edit and add pages to design the layout for use on a mobile device. Pages can be fully customized and designed with macros and buttons from different hardware devices and with any object, background, size, shape and color of your choice.

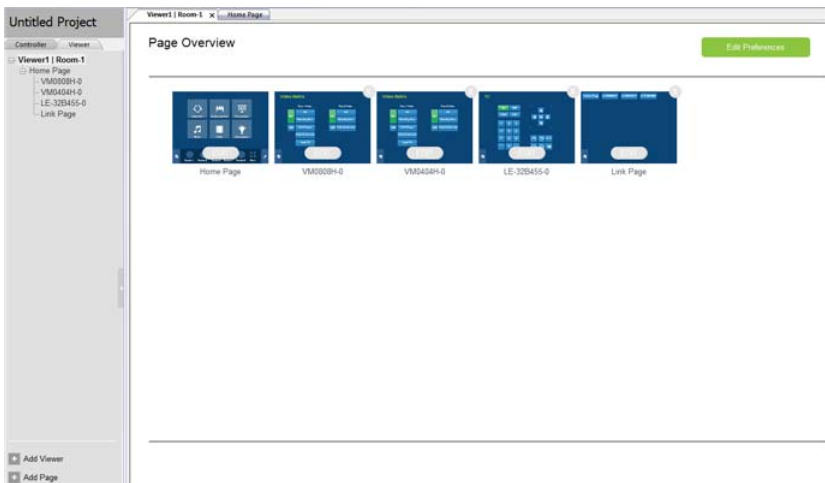

Page Overview	Shows the <b>Home Page</b> , <b>Link Page</b> and a <b>Control Page</b> for each hardware device added from the Device Library.
Edit	Click to customize a viewer page (see page 60).
X	Click the <b>X</b> located at the top right corner of the viewer page to delete it.
Add Page	Click to add a new page to the viewer.
Add Viewer	Click Add Viewer to create a new viewer.
Sidebar	Click a sidebar item to edit the viewer properties or a viewer page.
Edit Preferences	Click to return to the Select viewer page.

## Edit

Use **Edit** to customize the layout and design of a page. You can add custom buttons\*, labels, images, scroll view windows and backgrounds to the page. Buttons can be made into a **Link**, **Macro** or **Function** (page 65). On the sidebar, use the *Graphic Library* (page 78) to add objects and *Advanced Editor* (page 80) to configure advanced button actions. Objects can be layered, images can be imported and labels can be applied anywhere.

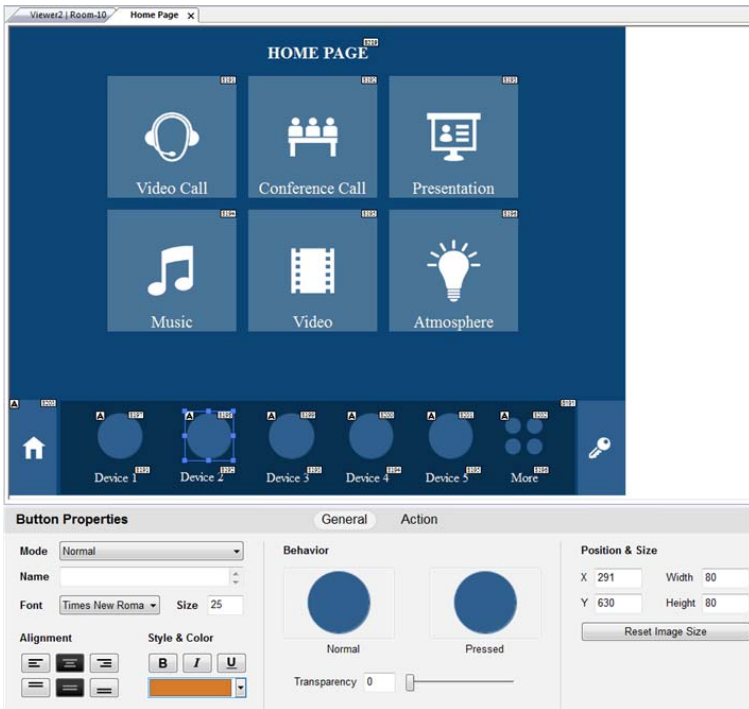

**Note:** The Windows OS has a limitation for adding buttons to viewer pages for use on Windows mobile devices. See *Windows OS Button Limitation*, page 63, for details.

- ◆ Selecting an object opens the **Properties** at the bottom of the page.
- ◆ Right click on the page to add a **Button**, **Label**, **Image**, **Scroll View** or **Video**.
- ◆ Drag and drop objects anywhere on the page.
- ◆ Right click on an object to select options.
- ◆ Click the mouse wheel to zoom the page in or out.

- ◆ Double-click on the page or an object to open the *Graphic Library*.
- ◆ Use the *Object* menu options to **Group**, **Order** or **Align** objects.
- ◆ Use the *View* menu options to select **Show Grid** and **Align to Grid** to set objects in perfect alignment.

## Page Objects

To help identify objects, a number appears at the top right corner. The numbers are assigned in sequence, in the order that the object is added. These numbers help identify labels when configuring a **Change Label** (page 76) or a button when configuring a **Change Button State** (page 75).

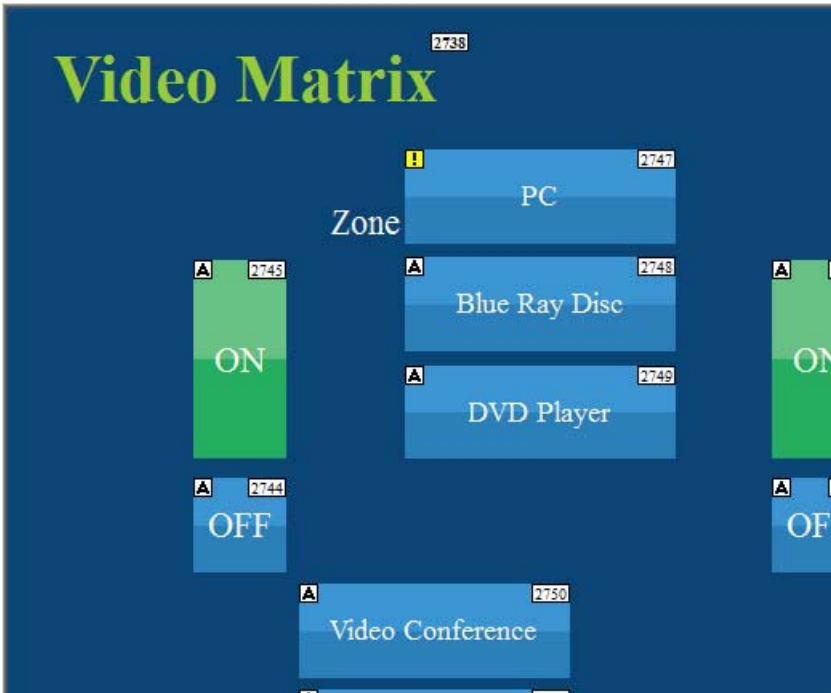

Each button has a symbol in the top left corner to indicate:

- ◆ “A” the button’s actions are configured correctly.
- ◆ “!” the button’s actions need to be modified or they will not work.
- ◆ A button without a symbol indicates that functions have not been added to it. For details on adding actions, see *Action*, page 66.



## Windows OS Button Limitation

When adding buttons to a viewer page for use on a Windows mobile device there is a Windows OS limitation for overlapping buttons. When two buttons are layered (A) on top of (B), the top most button (A) can not be pressed – instead (B) is activated each time. To resolve this issue, duplicate the top most button (A) and add it (C) directly under (A) and below (B) on the viewer page.



When the top button (A) is pressed, the lowest button (C) will execute the action.

## Properties

There are four types of properties that appear for different objects:

### ■ Page Properties

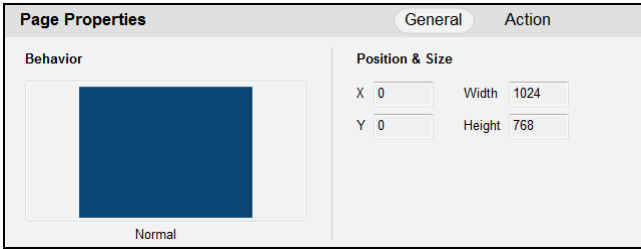

The *Page* properties provides options to change the background of the page.

- ◆ **Behavior** – click the box to import an image (\*.png,\*.jpg\*.jpeg\*.bmp) to use as the background for the page.
- ◆ **Position and Size** – displays the *Width* and *Length* of the page according to the *Resolution* set in the *Viewer Properties*.

### ■ Label Properties

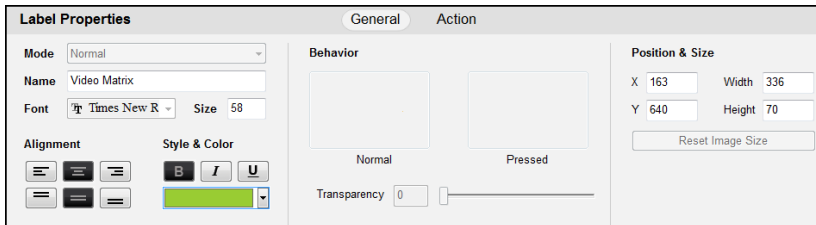

The *Label* properties provide options to change the text and formatting of a label.

- ◆ **Name** – enter the text you want to use for the label or slow double-click the label on the **Edit** page.
- ◆ **Font** – use the drop-down menu to select the font type.
- ◆ **Size** – enter a number (1-200) to set the size of the text.
- ◆ **Alignment** – aligns the text Right, Center or Left; and Top, Middle or Bottom within the label box.
- ◆ **Style & Color** – formats text to *Bold*, *Italic* or *Underline* for the label. Use the drop-down menu to change the color of the text.
- ◆ **Position and Size** – *X* and *Y* position the label at the coordinates entered. *Width* and *Height* set the size of the label.

## ■ Button Properties

The *Button* properties provide options under **General** and **Action** to configure the look and function of a button. A button can control a device, link to another page or run a macro.

### General



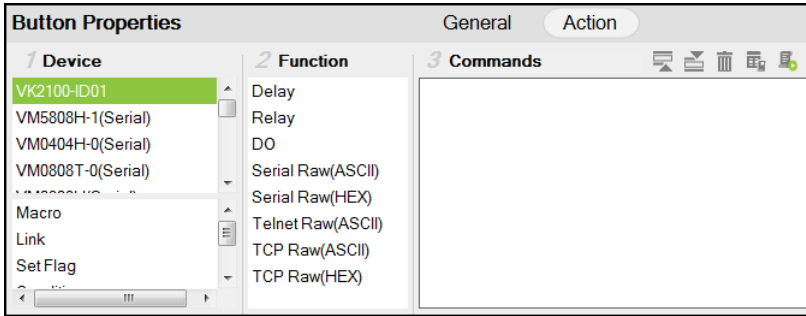

- ◆ **Mode** – use the drop-down menu to select the button type: *Normal* for a button that stays the same when pressed or *Toggle* for a button that switches between two images to indicate the status. Use the **Behavior** option to set the images. When *Toggle* is selected you must add a **Change Button State** action to the Commands list (see *Action* settings, page 75).
- ◆ **Name** – (optional) type the text you want to use for the button (or slow double-click the button on the **Edit** page to edit the text).
- ◆ **Font** – use the drop-down menu to select the font type.
- ◆ **Size** – enter a number (1-200) to set the size of the text for the button.
- ◆ **Alignment** – aligns the text Right, Center or Left; and Top, Middle or Bottom within the button box.
- ◆ **Style & Color** – formats text to *Bold*, *Italic* or *Underline* for the button. Use the drop-down menu to change the color of the text.
- ◆ **Behavior** – click *Normal* to import an image to use as the button's standard background and click *Pressed* to import an image to use when the button is pressed.
- ◆ **Transparency** – enter a number (0-100) or use the slider-bar to set the transparency of the button.
- ◆ **Position and Size** – *X* and *Y* position the button at the coordinates entered. *Width* and *Height* set the size of the button box.
- ◆ **Reset Image Size** – resets the button size.

(Continues on next page.)

## Action



The *Action* section of the Button Properties is used to set what a button does when pressed. Use the table below for an overview and the instructions on the next page to add *Actions* and *Advanced Options*.

Device	Lists the devices and other options that can be selected to add actions to the Button properties. When a device or option is selected, actions appear in the Function list. The upper box lists the hardware devices and VK2100; the lower box lists <i>Advanced Options</i> .
Function	Lists the actions that can be added to the Commands List. When a Device is selected the actions listed here can be added to the Commands List to configure the button.
Commands	Lists the actions that will initiate when the button is pressed. <i>Device Functions</i> and <i>Advanced Option</i> actions can be added and associated in the Commands list together. Actions initiate in the order that they're added.
Toggle ON / Toggle OFF	When the Button <b>Mode</b> (page 65) is set to <i>Toggle</i> , the <i>Commands</i> list splits in two and you can set the two toggle actions: <b>Toggle ON</b> – lists the actions that initiate when the button is first pressed. <b>Toggle OFF</b> – lists the actions that initiate when the button is pressed a second time. When the button is pressed again, the <i>Toggle ON</i> action initiates and the cycle repeats.
	Use <b>Move up</b> to move an action up in the Commands list, or <b>Move down</b> to move an action down in the Commands list.
	Use <b>Delete</b> to remove an action from the Commands list.
	Use <b>Save as Macro</b> to save the actions in the Commands list as a macro.
	Use <b>Test Tool</b> to connect to a controller and test the action(s) in the Commands list.

## Adding Actions

The *Action* section allows you to configure what a button does when pressed. You can configure a button for **Device** commands (On, Off, Stop, Play, etc.), as a **Macro** to send multiple commands to one or more devices, or as a **Link** to other viewer pages. *Advanced Options* allow you to add conditions to the actions, as described on the next page.

To add an action to the button:

1. Select an option under **Device**.
2. Select an action from the **Function** list.
3. Double-click the action to add it to the **Commands** list.

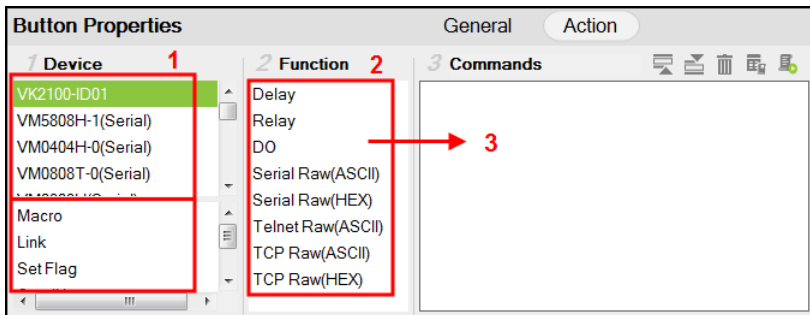

The actions that are listed under **Function** depend on the option selected in the **Device** list.

4. Use the information below to understand how each **Action** section works and how to add *Advanced Options* to actions.
  - ♦ **Device** – lists hardware devices and options that can be selected to add actions to the Commands list. Select an option to add actions from the **Function** list. Only hardware devices listed in the viewer's *Accessible Room* are listed here. The Controller is listed first and allows you to add *Special* actions, as explained under *Function*, on page 68. In addition to device actions, you can add a:

**Macro** – sends multiple commands to one or more devices. Select to add a macro from the **Function** list. To create a macro, add multiple device actions to the Commands list, then click the **Save as Macro**



icon or use the *Advanced Editor* (page 80).

**Link** – makes the button into a link that directs you to a viewer page. Select to add a page link from the **Function** list. Double-click the page link in the Commands list to select a different page link.

Below lists advanced options that provide additional features to set conditions with button actions. For more information on these options, see *Advanced Options*, page 70.

**Set Flag** – sets a flag value to represent the new device status when an action changes a device setting. Set Flags are added after an action (in the Commands list) to change the device status (Flag).

**Condition** – adds a condition that must be met for actions to initiate. The Condition's set value must be equal to a Flag or Feedback value for the action(s) to initiate. Conditions are added before actions in the Commands list.

**Change Button State** – this option changes the button image when toggling between two actions - allowing the image to switch with the toggle behavior: Normal or Pressed. Change Button State is added to the end of the Toggle ON and Toggle OFF Commands lists.

**Change Label** – this option changes a label's text with text that you enter manually or with text from a device's return message. A Manual Change Label can be added to the beginning or end and with a Condition in the Commands list. Adding it to a Condition guarantees the label only changes when the action initiates.

- ◆ **Function** – lists the actions that can be added to the Commands list. Select an option under **Device**, then double-click or drag & drop actions in the **Function** list to add them to the **Commands** list.

Associate **Set Flag**, **Condition**, **Change Button State**, or **Change Label** options with actions in the Commands list by dragging and dropping them into a tree view list, so that they initiate together (see *Advanced Options*, page 70).

If you select the Controller from the **Device** list, you can add the **Special** actions listed below. Double-click to add and double-click to configure:

**Delay** – adds a delay in seconds. Enter a number between 0.1-180.

**Relay** – adds an Open, Close, Toggle or Pulse action on the selected controller and Relay port.

**D/O** – adds an Open, Close, Toggle or Pulse action on the selected controller and Digital Output port.

**Serial Raw (ASCII)** – adds a serial command string that is entered for the port selected in ASCII mode.

**Serial Raw (HEX)** – adds a serial command string that is entered for the port selected in HEX mode.

**Telnet Raw (ASCII)** – adds a telnet command string that is entered for the device selected in ASCII mode.

**TCP Raw (ASCII)** – adds a TCP command string that is entered for the port selected in ASCII mode.

**TCP Raw (HEX)** – adds a TCP command string that is entered for the port selected in HEX mode.

- ◆ **Commands** – lists the actions that initiate when the button is pressed. Actions in the Command list can include device functions (on, off, switch, change setting, etc.) and options such as *conditions* that must be met (Flag, Feedback) before an action can initiate, or *changes* that initiate (Set Flag, Change Button State, Change Label) with the action.

When a device action has multiple functions you can double-click it in the Commands list and use the drop-down menu to select a device setting.

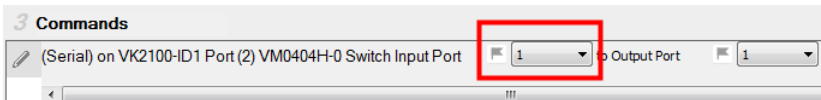

**Menu** – use the drop-down menu(s) to select a device setting for the action. The selection of settings in the drop-down menu can be modified using the Database Generator to edit the command string (see *Edit / Add New Device*, page 97).



**Show Flag Menu** – clicking this button allows a Flag with a set of values to be selected for the action. The button's action will select a setting according to the Flag value. Each value in a Flag can be set to a different device using a Set Flag (as a button to select the device). When that (Set Flag) button is pressed, the Flag value is set for that particular device, and will be used as the setting for this action, when it's button is pressed.

**Note:** The *Show Flag Menu* feature allows you to use a single Flag (for all devices) rather than adding a Conditional Flag (for each device) in the Commands list.

## Advanced Options

Advanced Options allow you to include conditions with an action in the Commands list. Associate **Set Flag**, **Condition**, **Change Button State** or **Change Label** functions with an action in the Commands list by dragging and dropping them into a tree view listed with the action, so that they initiate in the order listed.

- ◆ **Set Flag** – add a Set Flag to change a Flag’s value when an action changes a device setting. This sets the **Flag** value to match the new device setting (e.g. ON or OFF). Always add a **Set Flag** to a **Condition Flag**, after the device action(s):

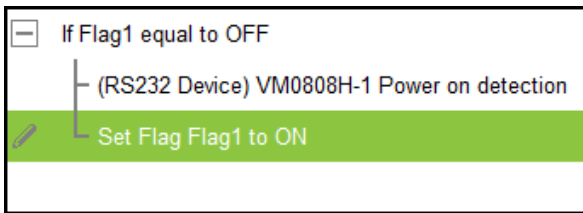

To add a Set Flag:

1. Select **Set Flag** under **Device**.
2. Select the **Flag** from the Function list.
3. Drag and drop the **Flag** from the **Function** list to add it to the end of the *Condition Flag*, in a tree view list:

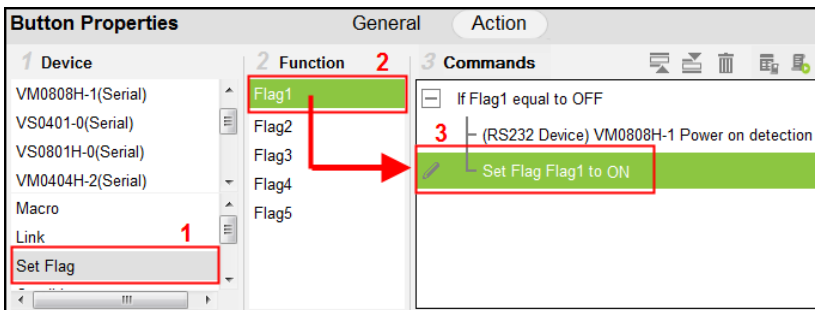

4. Double-click **Set Flag** in the Commands list to use the drop-down menus to set the **Flag** and **Value**.

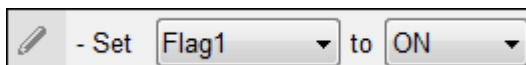



- ♦ **Condition** – adds a condition that must be met before the actions listed with it can initiate. When the button is pressed, the Condition's set value must equal the **Flag** or **Feedback** value for the action(s) to initiate. There are two condition types: **Flag** and **Feedback**.
- ♦ **Flag** – adds a condition based on a Flag's value. "If **Flag** equals **Value**" is true, the condition is met and the actions listed with the Condition will initiate. Always add a **Condition Flag** at the top of the Commands list, next drag and drop the device action(s) and a Set Flag at the end, in a tree view list:

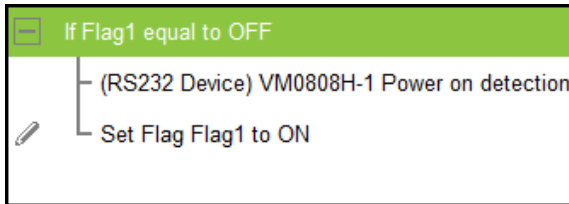

To add a Condition Flag:

1. Click **Condition** under **Device**.
2. Select **Flag** from the Function list.
3. Double-click **Flag** to add the Condition Flag to the **Commands** list.

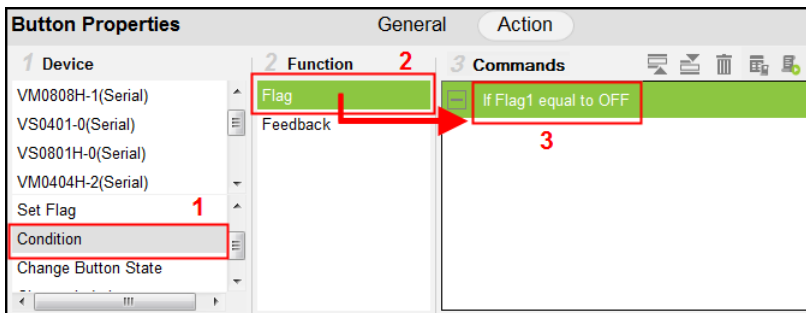

4. Double-click the **Condition Flag** in the Commands list to use the drop-down menus to set the **Flag** and **Value**.

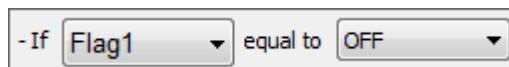

5. Drag & drop Device actions from the **Function** list to add them to the **Condition Flag**, in a tree view list:

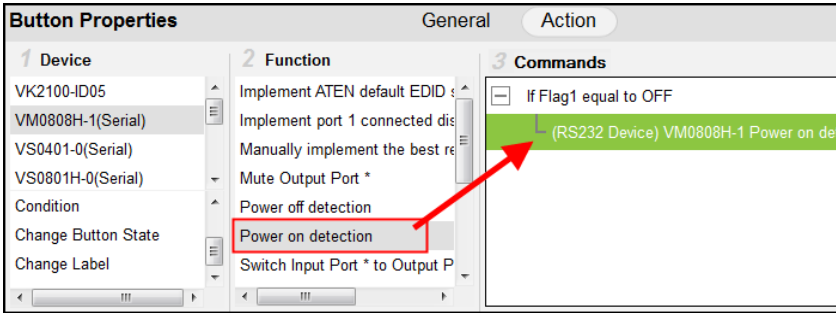

6. Add a **Set Flag** after the last device action in the **Commands** list:

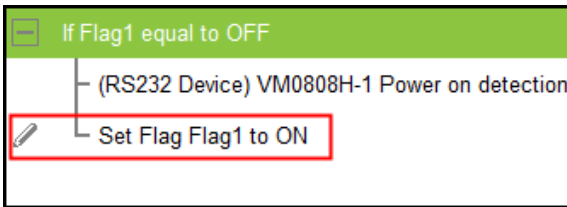

- ◆ **Feedback** – adds a condition based on the **text** from a serial/telnet device’s return message. Always add a **Condition Feedback** to a serial/telnet command, with action(s) added below the Condition Feedback, in a tree view list:

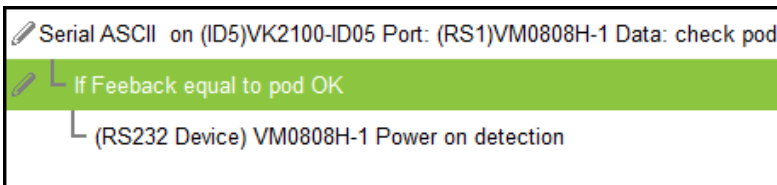

There are two Condition Feedback types:

- ◆ **Equals** – when the text sent from a serial/telnet device’s return message matches part of the text entered for a **Condition Feedback Equals**, the actions listed below it will initiate.
- ◆ **Bypass** – this option bypasses matching text from the serial/telnet return message and initiates a **Change Label** action. The label’s text will change to the return message sent from the device (i.e. the *Feedback Result*). A **Change Label** must be added to the **Feedback Bypass** for it to work.

To add a Condition Feedback Equals:

1. Click **Condition** under **Device**.
2. Select **Feedback** from the Function list.
3. Drag and Drop **Feedback** from the **Function** list to add it to the Serial/Telnet command, in a tree view list:

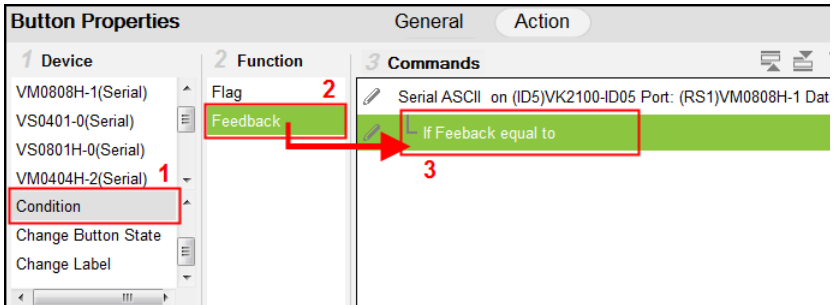

4. Double-click **If Feedback equals to** in the Commands list and use the drop-down menu to select **equal to** and enter the **Text**.

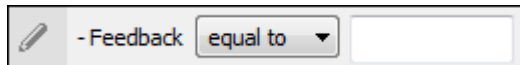

Text entered here must match part of the text from a serial/telnet device's return message for the action(s) to initiate.

5. Drag & drop device action(s) from the **Function** list to add them to the **Feedback Equals Condition**, in a tree view list:

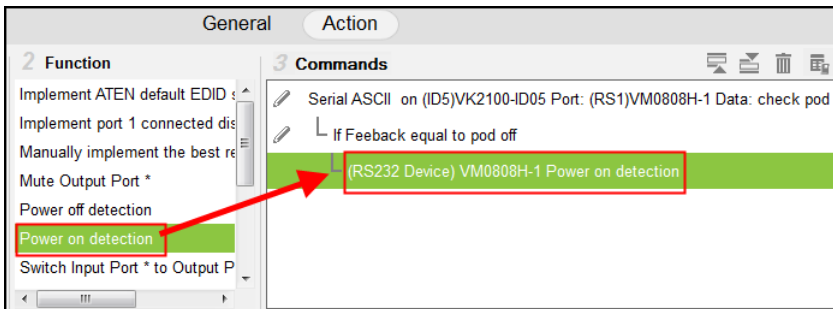

To add a Feedback Bypass Condition with Change Label:

1. Click **Condition** under **Device**.
2. Select **Feedback** from the Function list.
3. Drag and Drop **Feedback** from the **Function** list to add it to the Serial/Telnet command, in a tree view list:

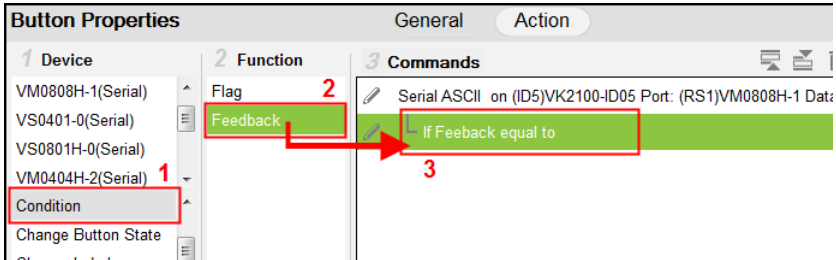

4. Double-click **If Feedback equals to** in the Commands list and use the drop-down menu to select **bypass**.

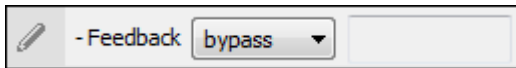

5. Select **Change Label**, under **Device**.
6. Select the **Device Page** where the label is located from the Function list.
7. Drag and drop the **Device Page** from the Function list to add it to the **Feedback Bypass Condition**, in a tree view list:

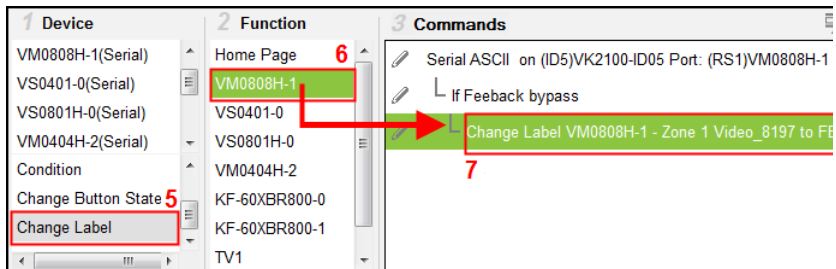

8. Double-click **Change Label** in the Commands list to use the drop-down menu and select the label you want to use. Labels can be identified by the number located in the upper right-hand corner of the object.

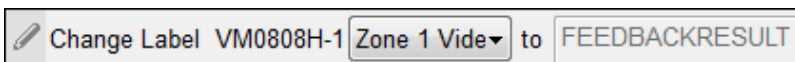

The label's text will change to the serial/telnet device's return message.

- ◆ **Change Button State** – this option is used to change the button image when toggling between two actions – allowing the button image to switch depending on the status: *Normal* or *Pressed*. Always add a **Change Button State** at the end of the action(s) in the Toggle ON and Toggle OFF Commands lists.

To add a Change Button State:

1. Under **General**, set the Button Mode to **Toggle**.
2. Under **Behavior**, select the **Normal** and **Pressed** button images.

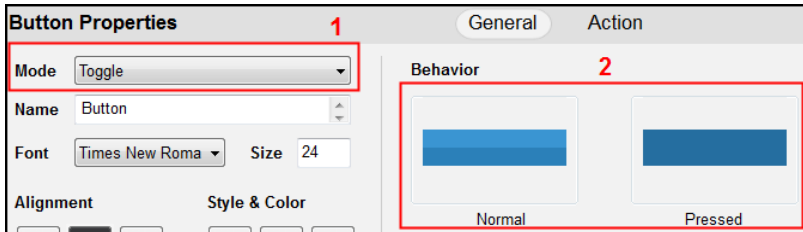

3. Add Toggle ON and Toggle OFF actions to the Commands lists.
4. Under **Device**, select **Change Button State**.
5. Select the **Device** in the Function list.
6. Select the **Toggle ON** radio button, then double-click the **Device** in the Function list to add it to the end of the *Toggle ON* Commands list.
7. Select the **Toggle OFF** radio button, then double-click the **Device** in the Function list to add it to the end of the *Toggle OFF* actions in the Commands list.

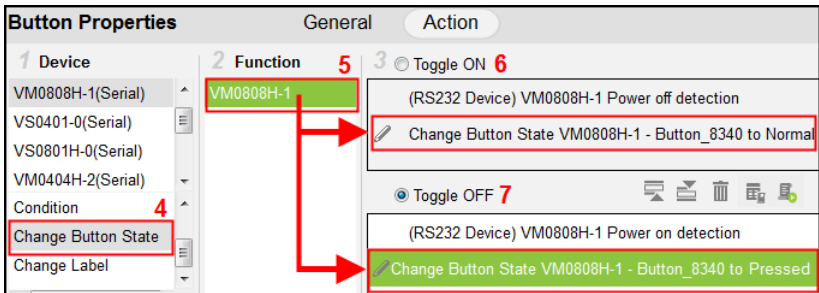

8. Double-click the **Change Button State** in each Commands list to set the **Button** and **Status** (*Normal* or *Pressed*).

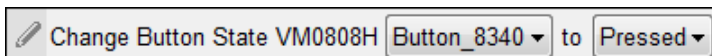

- ♦ **Change Label** – changes a label’s text with text that you enter manually or with text from a serial/telnet device’s return message (*Feedback Result*). A **Change Label** that uses a return message, must be added to a Feedback Bypass Condition (page 73). A **Manual Change Label** can be added anywhere in the Commands list. Adding it to a Condition guarantees the label changes only when the action initiates.

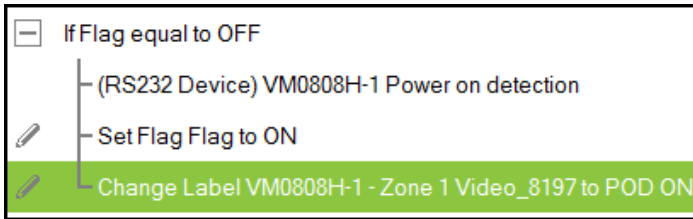

To add a Manual Change Label:

1. Click **Change Label** under **Device**.
2. Select the **Device Page** where the label is located from the Function list.
3. Double-click or drag and drop the **Device Page** to add the Change Label to the **Commands** list.

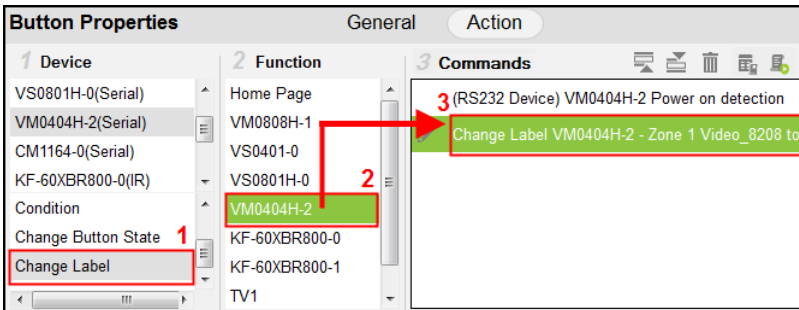

4. Add a **Change Label** to multiple or Toggle ON / Toggle OFF Commands lists to have the same label change text for different actions.
5. Double-click **Change Label** in the Commands list to use the drop-down menu to select a **Label** and input the **Text**. This is the text in the label that will appear when the button is pushed.

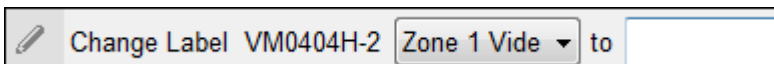

Repeat the steps to add a Change Label for the reverse action (i.g., **On** and **Off**).

## ■ Image Properties

The *Image* properties provide options under **General** to change and import images to the page. Images can be layered with other objects so that they can be placed as a background or as highlights for buttons (see image below). You can **Group**, **Order**, **Align**, **Make Same Size** or **Space Evenly** from the *Object* menu.

- ◆ **Behavior** – shows the image selected. Click inside the box to import an image (\*.png,\*.jpg,\*.jpeg,\*.bmp) to the page.
- ◆ **Transparency** – enter a number (0-100) or use the slider-bar to set the transparency of the image selected.
- ◆ **Position and Size** – X and Y position the image at the coordinates entered. *Width* and *Height* set the size of the image.
- ◆ **Reset Image Size** – resets the image size.

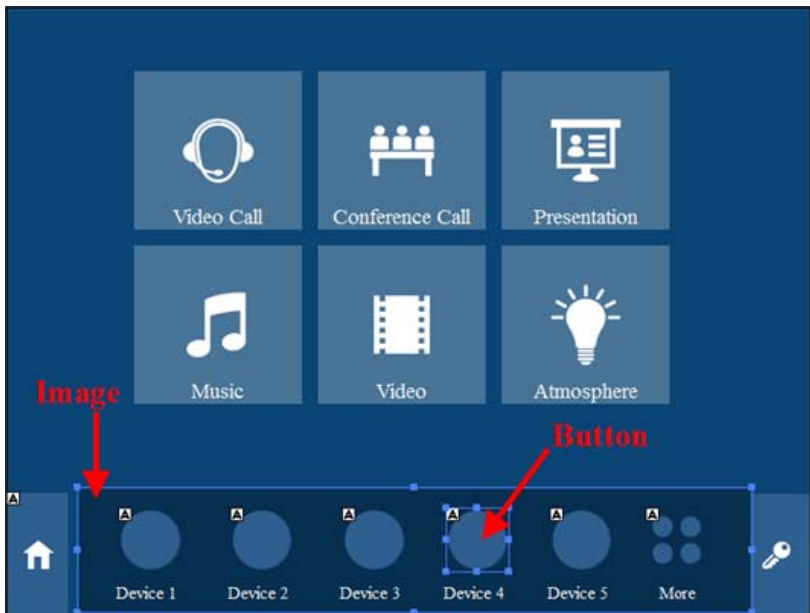

## **Graphic Library**

The *Graphic Library* on the sidebar provides ready-to-use objects for backgrounds, buttons, icons and device interfaces. Device Interface provides entire page layouts that you can use as templates for different types of devices. Double-click or drag and drop graphics to add them to the page. Images can be imported for icons and buttons in various formats (\*.png,\*.jpg,\*.jpeg,\*.bmp).

### **Background**

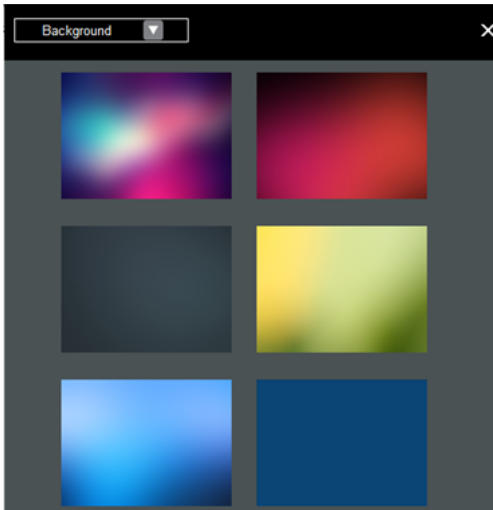

### **Button**

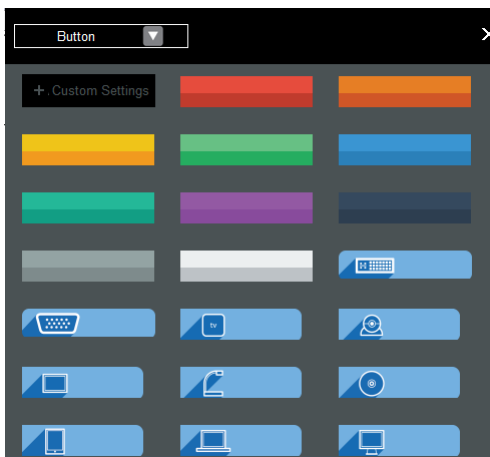



## Icon

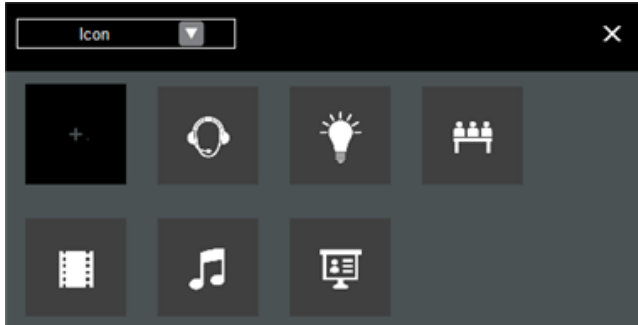

## Device Interface



## Advanced Editor

The *Advanced Editor* provides settings to create a **Macro** for buttons, a **Monitor** for events or a **Flag** to track settings. The table below gives a brief description of each section and the pages that follow provide instructions to create a macro and Monitor.

The screenshot shows the 'Advanced Editor' interface with three tabs: 'Macro', 'Monitor', and 'Flag'. The 'Macro' tab is active. The interface is divided into several sections:

- Select Viewer:** A dropdown menu currently showing 'Macro'.
- Condition:** A section for defining conditions, including a 'Name' input field, an 'Operator' dropdown menu (set to 'AND'), and three columns: 'Select Devices', 'Select Status', and 'Condition List'.
- Actions:** A section for defining actions, divided into three columns: '1 Device', '2 Function', and '3 Commands'. The 'Commands' column contains a list of actions with icons for adding, deleting, and refreshing.

Macro	Macros initiate a sequence of actions on one or more hardware devices.
Monitor	Monitors allow you to set Conditions for Digital Input (dry contact) and Digital Input (VDC) signals and Flags on a port that will initiate an Action.
Flag	Flags are created to include parameters when settings are changed to indicate the current status.
+ New	Opens a pop-up menu to create a Macro, Monitor or Flag.
Select Viewer	Lists the viewers available to create a Macro or Monitor setting for. Click on a viewer to see the list of Preset macros or Preset Monitors that have been created.
Preset Macro / Monitor	When you click a viewer under <i>Select Viewer</i> – the macros or monitors created for it will be listed here. Click on a Preset Macro or Monitor to configure its settings.
Condition	This section is for Monitor settings only and is used to set the conditions for signals sent from Digital Input (dry contact), Digital Input (VDC) devices and Flags.
Actions	This section is used to add actions to the Macro or Monitor. Actions added to the Action list will initiate when a custom button (Macro) is pressed or port signals (monitor) meet a set condition.

## Macro

Macros allow you to create a button that will initiate a sequence of actions across the same or different hardware devices. This saves time by allowing multiple devices to initiate actions all at once from one button. For example, you can create a macro to start a video presentation by adding functions to: dim lights, power on source, power on display, lower screen and play source. You can also add time delays between actions in a macro.

To create a macro:

1. Select **Macro** and click + **New**.

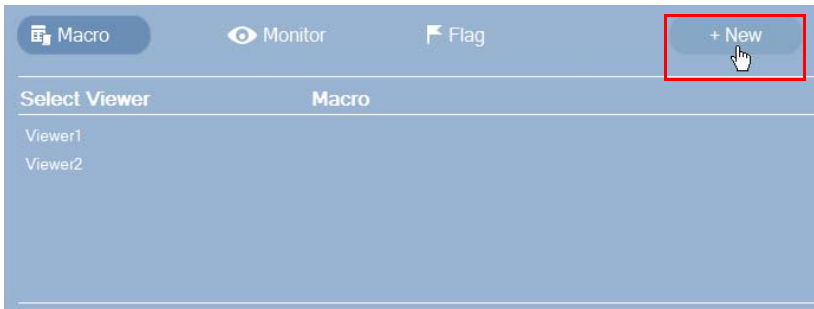

2. The *New Macro* pop-up menu appears:

 A screenshot of a 'New Macro' pop-up dialog box. The dialog has a green header bar with the text 'New Macro'. Inside the dialog, there is a 'Name' label followed by a text input field. Below that is a 'Viewer' label followed by a drop-down menu currently showing 'Viewer1'. At the bottom of the dialog, there are two buttons: 'OK' and 'Cancel'.

Enter a **Name** and select a **Viewer** from the drop-down menu, then click **OK**.

3. Select the viewer and click the macro name under **Macro**:

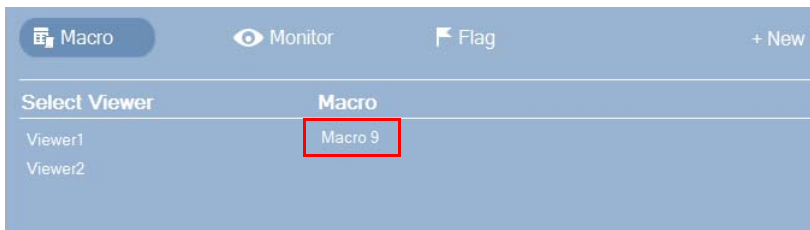

- Go to the *Actions* section at the bottom of the page to select hardware under **Device** and add the **Function** to the **Commands** list:

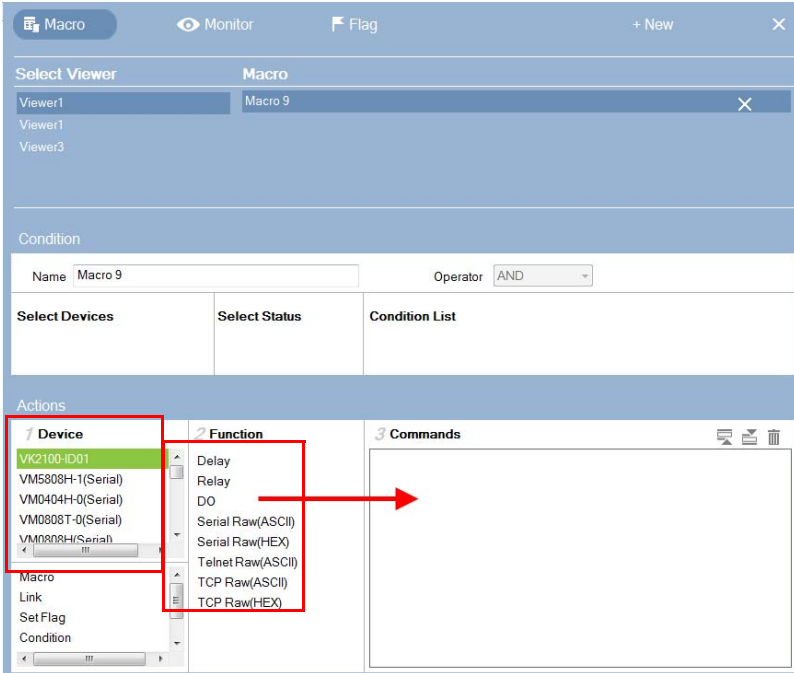

**Note:** For more information on adding Functions, see *Action*, page 66.

- After adding all the functions to the *Action List*, the macro is complete.
- In *Create Viewer & Design*, create a button and add a macro to the *Button Properties* from the **Action** tab by selecting **Macro** under *Devices* (see *Adding Actions*, page 67 for details)

## Monitor

A *Monitor* allows you to set the conditions on a port for the signals from **Digital Input (VDC)** and **Digital Input (Dry Contact)** devices or **Flags** that will initiate an action. Digital Input (VDC) hardware devices provide voltage signals between 1 and 24. Digital Input (Dry Contact) are hardware devices with open and closed circuit signals. These signals provide indicators from sensors or switches of an event. An event can be the temperature, power, dry contact, sensor or switching status from a device.

Create a monitor for a Digital Input port with a **Condition** that specifies an **Action** according to the signal sent from the device.

To create a Monitor:

1. Select **Monitor** and click **+ New**.



2. The *New Monitor* menu appears:

 A screenshot of a dialog box titled 'New Monitor'. The dialog has a light green header. It contains two input fields: 'Name' with an empty text box, and 'Viewer' with a dropdown menu showing 'Viewer1'. At the bottom of the dialog, there are two buttons: 'OK' and 'Cancel'.

Enter a **Name** and select the **Viewer** (associated with the room/device you are configuring) from the drop-down menu, then click **OK**.

3. Select the *Viewer* under **Select Viewer** and click the *Monitor* under **Monitor (Uncheck to disable)**:



4. Under **Condition**, use the drop-down menu to select the **Operator**:

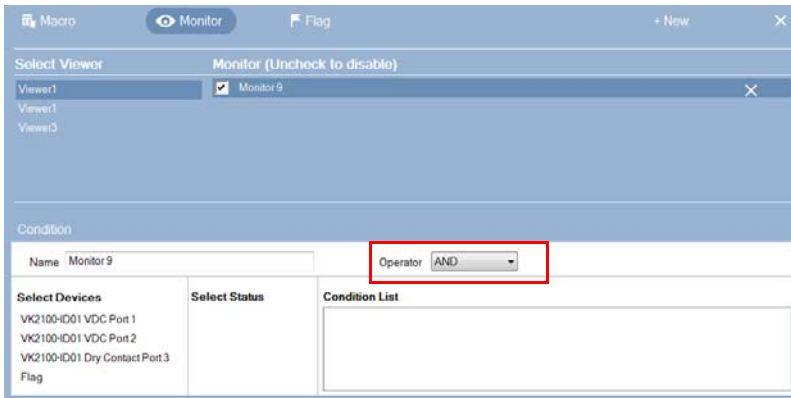

Operator options are only for advanced setups that require multiple events from hardware devices connected to multiple D/I ports. Most devices only require one signal Status added to the *Condition List* to initiate an *Action*. Most installations will not need to use the Operator option, therefore it can be ignored.

**AND:** Add multiple conditions from different D/I ports – all of which must be met for the Action to initiate.

**OR:** Add multiple conditions from different D/I ports – one of which must be met for the Action to initiate.

5. Under **Select Devices**, select the D/I port:

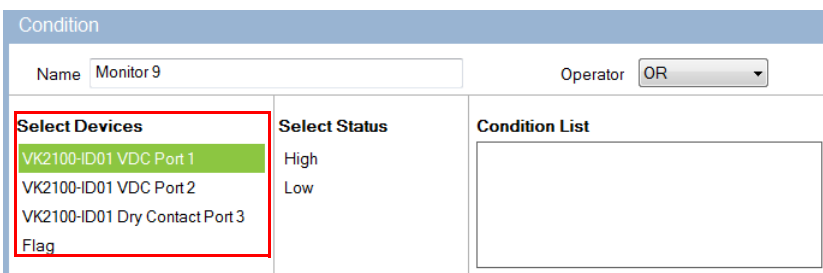

**Note:** The *Viewer* selected for the monitor must have a Digital Input (dry contract) or Digital Input (VDC) port or a Flag configured for devices to appear in the list.

6. Under **Select Status**, add a status to the Condition List:

Condition		
Name	Monitor 9	
	Operator	OR
Select Devices	Select Status	Condition List
VK2100-ID01 VDC Port 1	High	VK2100-ID01 VDC Port 1 == High
VK2100-ID01 VDC Port 2	Low	
VK2100-ID01 Dry Contact Port 3		
Flag		

The High or Low status tells the Monitor to initiate an Action when the device signal is above or below the threshold setting\* for the port:

### Digital Input (VDC)

- ♦ High - states that when the voltage signal is above the **Upper** Threshold to initiate the Action.
- ♦ Low - states that when the voltage signal is below the **Lower** Threshold to initiate the Action.

### Digital Input (Dry Contact)

According to an open or closed circuit status for the port:

- ♦ Open - states that when the circuit is **Open** to initiate the Action.
- ♦ Closed - states that when the circuit is **Closed** to initiate the Action.

**Note:** To configure the Upper and Lower threshold for the Digital Input port, see *Left Sidebar*, page 49.

7. (Optional) Use the Operator option to add additional High or Low conditions (see step 4, page 84).
8. Go to the *Actions* section at the bottom of the page to select the hardware **Device** and add the **Function** to the **Commands** list:

Actions		
1 Device	2 Function	3 Commands
VK2100-ID01	Delay	
VM5808H-1(Serial)	Relay	
VM0404H-0(Serial)	DO	
VM0808T-0(Serial)	Serial Raw(ASCII)	
VM0808H(Serial)	Serial Raw(HEX)	
Macro	Telnet Raw(ASCII)	
Link	TCP Raw(ASCII)	
	TCP Raw(HEX)	

**Note:** For more information on Functions, see *Action*, page 66.

9. First select the hardware under **Devices**.

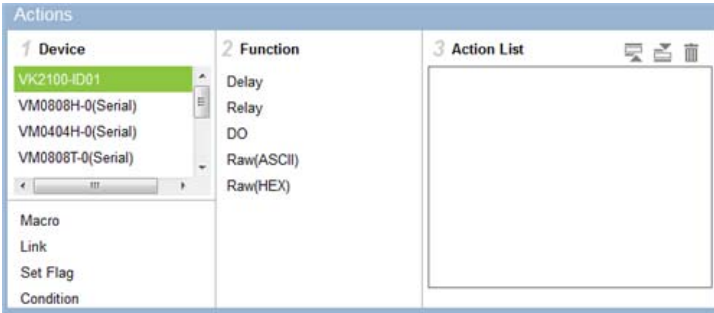

If you select a VK2100, you can add special actions and double-click on them in the *Action List* box to configure:

**Delay** – adds a delay in seconds. Enter a number between 0.1-180.

**Relay** – adds an Open, Close, Toggle or Pulse action on the selected controller and Relay port.

**D/O** – adds an Open, Close, Toggle or Pulse action on the selected controller and Digital Output port.

**Serial Raw (ASCII)** – adds a serial command string that is entered for the port selected in ASCII mode.

**Serial Raw (HEX)** – adds a serial command string that is entered for the port selected in HEX mode.

**Telnet Raw (ASCII)** – adds a telnet command string that is entered for the device selected in ASCII mode.

**TCP Raw (ASCII)** – adds a TCP command string that is entered for the port selected in ASCII mode.

**TCP Raw (HEX)** – adds a TCP command string that is entered for the port selected in HEX mode.

10. From the **Function** list, double-click an action to add it to the **Action List**.

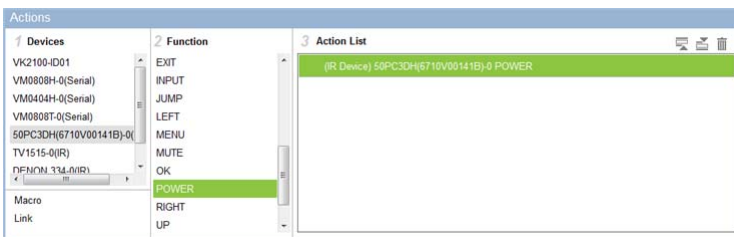



This is the **Action** that initiates when the **Condition** is met.

11. You can also add a **Macro, Link, Set Flag** or **Condition**.
12. After adding all the functions to the *Action List*, the monitor is complete.

## Flag

*Flags* are created for control buttons to include parameters for when settings are changed or requests are made to change settings on a device. Flags indicate what the status is and what action to take according to the value. Flags are added as actions to *Button Properties* as a **Condition** or **Set Flag** value.

*Conditions* tell a button to initiate associated actions if the flag value is true: “If **Flag** equals **Value**” initiate the action. Actions are associated with a condition so that they only initiate if the flag value is correct. That way an ON command is only sent to a device if the current flag value is OFF.

*Set Flag* changes the flag value when a device setting has changed. So that if a device is OFF and the action turns the device ON, adding a “Set Flag 1 to ON” will change the flag value to ON. Now the flag’s value matches the device status so that actions associated with flag Conditions will initiate accordingly.

Create flags for a device and add them as a *Condition* and *Set Flag* value in the *Action – Button Properties* (see *Action*, page 66).

To create a Flag:

1. Select **Flag** and click + **New**.

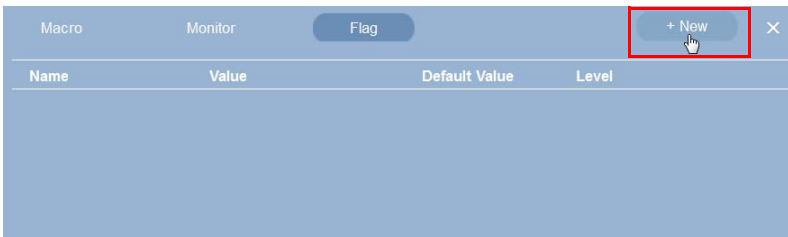

2. The *New Flag* menu appears:

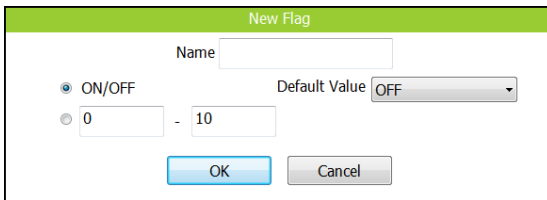

Enter a **Name** and use a radio button to set the flag value:

- ◆ Select **On/Off** and use the drop-down menu to select the *Default Value*.
- ◆ Enter a range (1-100) for the values in the two boxes and use the drop-down menu to select the *Default Value*.

- Click **OK** to create more flags or **Cancel** when you are finished. The flags will appear in the list below.

Macro		Monitor	Flag	
Name	Value	Default Value	Level	
Flag 1	1 - 10	1	9	
Flag 2	OFF, ON	ON	2	
Flag 3	OFF, ON	OFF	2	
Flag 4	1 - 100	1	99	
Flag 5	1 - 100	54	99	
Flag 6	1 - 10	7	9	

**Name** – Lists the Flag names which have been created.

**Value** – Lists the flag's values or range of values.

**Default Value** – Lists the flag's default value.

**Level** – Lists the number of values available for the flag.

- Select **Condition** or **Set Flag** to add flags as Actions in the Button Properties of the device's viewer page (see *Action*, page 66).

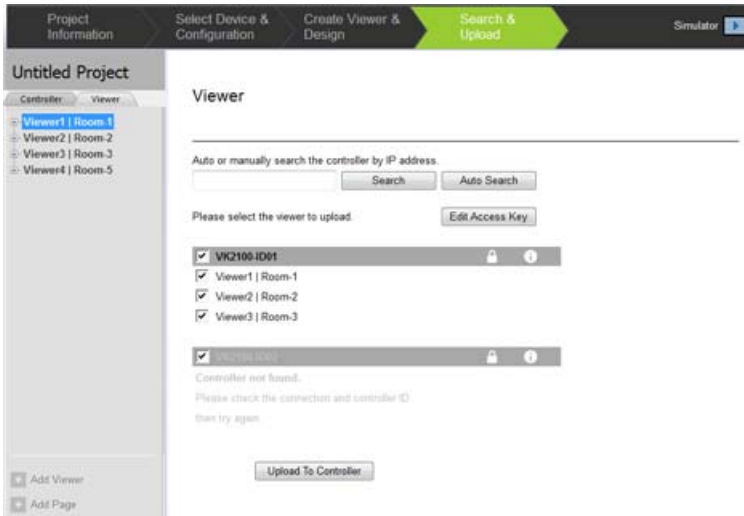

## Search & Upload

The *Search & Upload* page lets you search for **Controllers** and upload the **Viewers**. Viewers created for each Controller will be listed below the Controller. The *Accessible Room* selected for a viewer determines which Controller it uploads to – based on both having the same room number.



If Controllers can not be found, check the Controller ID Switch on the VK2100 – it should match the ID # of the Controller (VK2100-ID01) in the ATEN Configurator software.

Search	Enter the IP address and click <b>Search</b> to locate a Controller.
Auto Search	Click to locate Controllers without specifying an IP address. This option only searches for controllers on the same local area network. For controllers across a network device, such as a router or switch, you must specify the IP address.
Edit Access Key	Allows you to change the password required to upload viewers to the controller and download viewers from a mobile device.
	<p>These icons can be clicked to enable or disable the Access Key:</p> <p><b>Locked:</b> The Access Key is required to upload viewers to the controller and download viewers from a mobile device.</p> <p><b>Unlocked:</b> The Access Key is <b>not</b> required to upload viewers to the controller and download viewers from a mobile device.</p> <p><b>Note:</b> If you attempt to change the lock status and the Access Key has been changed from the Dashboard, a window will pop-up and you will need to enter the new Access Key.</p>

	<p>If the Access Key has been changed on the controller via the Dashboard, the lock icon will appear with an <b>X</b>, indicating you need to enter the new Access Key to change the Locked/Unlocked status.</p>
	<p>Click to view information about the Controller:</p> <ul style="list-style-type: none"> <li>◆ <b>IP Address:</b> Displays the controller's IP address.</li> <li>◆ <b>MAC Address:</b> Displays the controller's MAC address.</li> <li>◆ <b>License:</b> Displays the number of licenses available and being used. <ul style="list-style-type: none"> <li>◆ <b>Select License:</b> Allows you to load a new license file.</li> <li>◆ <b>Reset License:</b> Resets all license(s) in use by mobile devices. This will disconnect all mobile device connections to the controller(s).</li> </ul> </li> <li>◆ <b>Firmware Version:</b> Displays the firmware version of the controller. <ul style="list-style-type: none"> <li>◆ <b>Select Firmware:</b> Allows you to load a firmware upgrade file to update the controller's firmware.</li> </ul> </li> <li>◆ <b>Capacity:</b> Displays the amount of space available on the controller for uploading viewers.</li> <li>◆ <b>Existing Viewers:</b> Lists the viewers currently stored on the VK2100. <ul style="list-style-type: none"> <li>◆ <b>Remove Viewer:</b> Click to remove the viewer stored on the controller.</li> </ul> </li> </ul>
<p>Upload to Controller</p>	<p>When Controllers are found, this option allows you to select the Controllers and viewers to upload. Once a selection is made, click <b>Upload to Controller</b>.</p>

This Page Intentionally Left Blank

# Chapter 6

## ATEN Database Generator

### Overview

---

The *ATEN Database Generator* lets you add, edit and manage hardware devices for **My Device Library**. To open the Database Generator from the ATEN Configurator, use the menu bar to select *Tools* → *Database Generator*. The first time the application is opened, a window appears with four options:

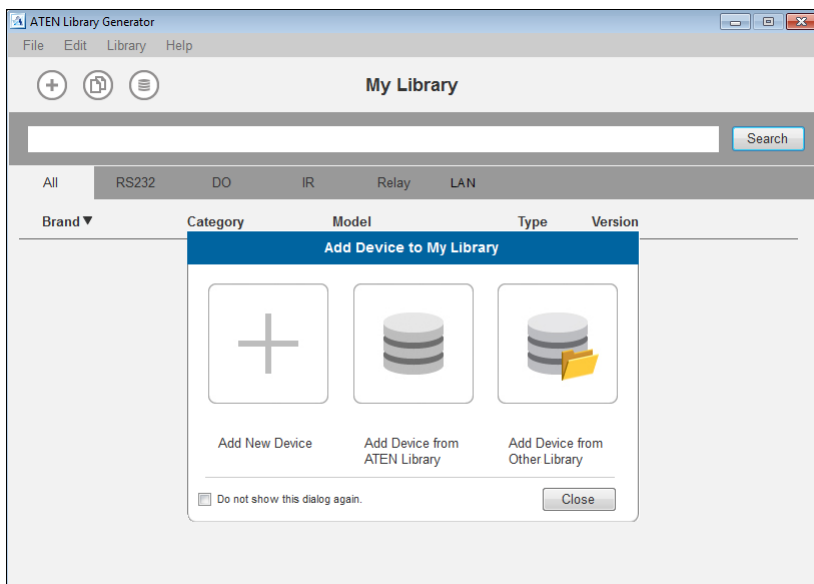

Add New Device	Configure a custom hardware device to add to My Library.
Add Device from ATEN Library	Add devices from the ATEN Device Library to My Library.
Add Device from Others Library	Add devices from a database file (*.vkd) to My Library.
Check Box	Click <i>Do not show this dialog again</i> to prevent the dialog from appearing when the Database Generator is opened. Use the Preferences menu option to bring the dialog window back.
Close	Click the <b>Close</b> button to exit the dialog window.

---

## My Library

*My Library* allows you to create a custom list of hardware devices which can be selected to configure ports on the VK2100. **My Library** lists all the hardware devices that you have created, added and edited using the Database Generator. You can create new hardware devices and/or add existing devices from the ATEN Library (page 106). These devices can then be selected from **My Device Library** (page 51) for use.

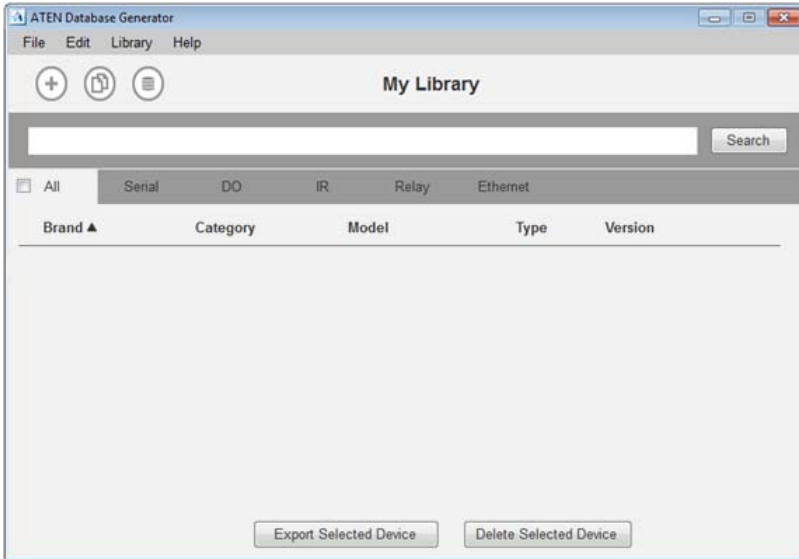

Menu	Description
File	<p>The <i>File</i> menu provides options to:</p> <ul style="list-style-type: none"> <li>◆ <b>Add New Device:</b> Configure a custom hardware device to add to Device Library.</li> <li>◆ <b>Add Device from ATEN Library:</b> Add devices from the ATEN Device Library to My Library.</li> <li>◆ <b>Add Device from another Library:</b> Add devices from a database file (*.vkd) to My Library.</li> <li>◆ <b>Export My Library:</b> Saves My Library as a database file (*.vkd) that can be imported later.</li> <li>◆ <b>Export Selected Device:</b> Saves the selected device(s) as a database file (*.vkd) that can be imported later.</li> <li>◆ <b>Controller Connection:</b> Searches for a controller to test the connection or run the learning mode for the IR port.</li> <li>◆ <b>Quit:</b> Exits the program.</li> </ul>



Menu	Description
Edit	<p>The <i>Edit</i> menu provides options to:</p> <ul style="list-style-type: none"><li>◆ <b>Delete:</b> Deletes the selected devices from the database.</li><li>◆ <b>Duplicate:</b> Makes a copy of the selected device(s) and adds them to the library with the extension “-Copy”</li><li>◆ <b>Preferences:</b> Provides options to:<ul style="list-style-type: none"><li>◆ Set the Language</li><li>◆ Show Add Device dialog on startup</li><li>◆ Show IR Learning tips</li><li>◆ Set the IR Learning Timeout - how long to attempt a connection to an IR device before IR learning stops.</li></ul></li></ul>
Library	<p>Provides a list of the Libraries that you can open to select devices from and edit or add to My Library. The libraries that are listed here appear when you select a database using <i>Add Device from another Library</i>.</p>
Help	<p>The Help menu provides two options:</p> <ul style="list-style-type: none"><li>◆ <b>Update ATEN Library:</b> Allows you to browse for a database file (*.vdk) to import devices into the ATEN library.</li><li>◆ <b>About:</b> Provides support and software version information.</li></ul>

## Managing My Library

When devices are added to My Library, they appear listed in the main window. New devices can be added by creating a new device, copying an existing device or by selecting a device from the ATEN Library. Use the check boxes to select individual devices or **All** to select the entire list.

The screenshot shows the 'My Library' window with a search bar and filter tabs (All, Serial, IR, DO, Relay, Ethernet). Below the tabs is a table with the following data:

Brand ▲	Category	Model	Type	Version	
<input checked="" type="checkbox"/> ACME	CABLE	56	Ethernet	V1.0	<b>Edit</b>
<input type="checkbox"/> ACME	Converters	ZAC SERIES-Copy	IR/Serial/O/RELAY	V1.0	
<input type="checkbox"/> Aten	Video Matrix Switches	VM0808H	IR/Serial	V2.2.219.223	
<input type="checkbox"/> Aten	Video Matrix Switches	VM0808H	IR/Serial	V2.2.219.224	
<input type="checkbox"/> Aten	Video Matrix Switches	VM0808T	Serial	V1.2.118	
<input type="checkbox"/> Aten	Video Matrix Switches	VM5808H	Serial	v1.2.116	
<input type="checkbox"/> Aten	Video Splitters	VS0104	Serial	V1.1.102	
<input type="checkbox"/> Aten	Video Splitters	VS0108	Serial	V1.1.102	
<input type="checkbox"/> Aten	Video Switches	VS0108HA	Serial	V1.0.068	
<input type="checkbox"/> ee	aa	1	Serial	2	
<input type="checkbox"/> YAMAHA	AUDIO	AX-497	IR	V1.0	
<input type="checkbox"/> YAMAHA	AUDIO	AX-596	IR	V1.0	
<input type="checkbox"/> YAMAHA	TV	DPX-1000[0D1]	IR	V1.0	
<input type="checkbox"/> ZENITH	TV	B25A74R	IR	V1.0	
<input type="checkbox"/> ZENITH	TV	B50M90W	IR	V1.0	
<input type="checkbox"/> ZENITH	TV	P42W22	IR	V1.0	

Buttons at the bottom:



Click to add a new custom device to the database.



Select a device and click this icon to create a duplicate.



Click to add and edit a device from the ATEN Library.

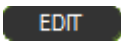

Select a device and click **Edit** to change the settings.

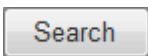

Key in word strings then click **Search** to find a device.

- ◆ Click **All**, **Serial**, **IR**, **DO**, **Relay** or **Ethernet** to filter the list by type.
- ◆ Click **Brand**, **Category**, **Model**, **Type** or **Version** to sort the devices.
- ◆ Click **Export Selected Device** to save the selected devices.
- ◆ Click **Delete Selected Devices** to remove the selected devices.

## Edit / Add New Device

To edit or add a device to My Library, do the following:

1. From the menu select **File** → **Add New Device**, or select a device from My Library and click **Edit**.
2. Under **General**, use the drop-down menus or type in the *Brand Name*, *Category*, *Model* and *Version*.  
**Note:** The *Category* determines what buttons are auto generated when a viewer page is created for the device.
3. Use the **History** button to open the *Version History* editor and make notes about the updates being made to the device configuration. You can create and use different versions of the same device and track the changes. The version history can be viewed and different versions selected from the ATEN Configurator, under device **Properties** (see page 49).
4. Check the hardware type and configure the device:

### Serial

General		Function List											
Brand	<input type="text"/>	Serial   IR   DO   Relay   Ethernet											
Category	<input type="text"/>	String Format											
Model	<input type="text"/>	<input type="button" value="HEX"/> <input type="button" value="ASCII"/> <input type="button" value="+"/> <input type="button" value="⌘"/> <input type="button" value="⌘"/> <input type="button" value="⌘"/> <input type="button" value="⌘"/> <input type="button" value="⌘"/>											
Version	<input type="text"/> <input type="button" value="History"/>	<table border="1"> <thead> <tr> <th>Function ▲</th> <th>Command</th> <th>Feedback</th> <th></th> </tr> </thead> <tbody> <tr> <td>Turn on OutputPort*</td> <td>sw o[01-04] on/!n</td> <td>Retrieve</td> <td><input type="button" value="Send"/></td> </tr> </tbody> </table>				Function ▲	Command	Feedback		Turn on OutputPort*	sw o[01-04] on/!n	Retrieve	<input type="button" value="Send"/>
Function ▲	Command	Feedback											
Turn on OutputPort*	sw o[01-04] on/!n	Retrieve	<input type="button" value="Send"/>										
Type	<input checked="" type="checkbox"/> Serial <input type="checkbox"/> IR <input type="checkbox"/> Digital Output <input type="checkbox"/> Relay <input type="checkbox"/> Ethernet												
Settings													
Baud Rate	<input type="text" value="9600"/>												
Data Bit	<input type="text" value="8"/>												
Stop Bit	<input type="text" value="1"/>												
Parity	<input type="text" value="None"/>												
Flow Control	<input type="text" value="None"/>												
Mode	<input type="text" value="RS232"/>												



Click to add an Action.



Click to create a duplicate of the Action.



Click to add a drop menu into a Command string, then enter the number sequence in the brackets []. The **Function** name must include an Astrix (\*) for each drop menu in the Command string. The drop-down menu will appear where the (\*) is entered in the Function name.



Click to add an *Enter* into the Command string.



Click to open a list of commands to add into the Command string.



Click to delete the selected action.

- ◆ **Settings** – Use the drop-down menus to set the: *Baud Rate, Data Bit, Stop Bit, Parity, Flow Control* and *Mode* settings.

- ◆ **Function List** – Use this section to configure the device functions by adding actions to the list.

**String Format** – Use the buttons to select *HEX* or *ASCII*.

**Function** – Lists the actions created for a device. A Function name must include an Asterisk (\*) if you are adding a drop menu to the Command string. Double click to edit the function name.

**Command** – Shows the command string created for the action. Double-click to edit the string.

**Feedback** – Provides the **Retrieve** and **Send** buttons used to test the command strings.

**Retrieve** – To use this button refer to the instructions on page 103.

**Send** – To use this button refer to the instructions on page 103.

## ■ IR

General		Function List				
Brand	<input type="text"/>	Serial	IR	DO	Relay	Ethernet
Category	<input type="text"/>	Quick Mode <span style="float: right;">+  </span>				
Model	<input type="text"/>	Function ▲		Status		
Version	<input type="text"/> <span>History</span>	Function name 1 <span style="float: right;">Learn Test</span>				
Type	<input type="checkbox"/> Serial <input checked="" type="checkbox"/> IR <input type="checkbox"/> Digital Output <input type="checkbox"/> Relay <input type="checkbox"/> Ethernet					
Settings						
Repeat	3 Times					



Click to add an Action.



Click to create a duplicate of the Action



Click to delete the selected action.

- ◆ **Settings** – Use the drop-down menu to set the **Repeat** setting (number of times a signal is sent): *1 Time, 2 Times or 3 Times (Default)*.
- ◆ **Function List** – Use this section to configure the IR functions by adding actions to the list.

**Quick Mode** – Click to run Learning Mode for all IR actions in the Function List. When the Quick Mode window opens, click **Start**, a pop-up window appears to select a controller. Check a box to select a controller and click **Select**. Click **Start** a second time to run Quick Mode using the *Learn* instructions below.

**Function** – Lists the actions created for a device. Double-click to edit the Function the name.

**Status** – Reports the status (**Tested, Failed, Learned**) of the Learn and Test buttons.

**Learn** – Use to transfer commands from an IR remote to the VK2100.

Click **Learn**, a pop-up window appears to select a controller. Check a box to choose a controller and click **Select**.

Click **Learn** a second time to start learning mode. When the IR Learn LED flashes green, point the IR remote at the VK2100's front panel IR Receiver and push a button on the remote. Press the button on the remote just as you would when using it with the hardware

device. If the device responds to a *long hold* or *quick tap* of the remote's button then you must press the button in the same manner (long hold or quick tap) when it using for Learning mode. The VK2100 will beep and the Learn LED will light solid (then turn off) when IR learning is successful. The LED also turns off if Learning mode times out.

**Test** – Use to test if commands are sent successfully to the VK2100 and hardware device.

Click **Test**, a pop-up window appears to select a controller and the IR port. Check a box to choose a controller and use the drop-down menu to select the IR port and then click **Select**.

Click **Test** a second time to test if the IR data transmits successfully to the controller. Check the hardware device to confirm that it responded appropriately.

The **Status** column reports the Learn and Test results.

## ■ Digital Output

<p><b>General</b></p> <p>Brand <input type="text"/></p> <p>Category <input type="text"/></p> <p>Model <input type="text"/></p> <p>Version <input type="text"/> <input type="button" value="History"/></p> <p>Type</p> <p><input type="checkbox"/> Serial</p> <p><input type="checkbox"/> IR</p> <p><input checked="" type="checkbox"/> Digital Output</p> <p><input type="checkbox"/> Relay</p> <p><input type="checkbox"/> Ethernet</p>	<p><b>Function List</b>    Serial    IR    DO    Relay    Ethernet</p> <p style="text-align: right;">+    📄    🗑️</p> <table border="1"> <thead> <tr> <th>Function ▲</th> <th>Command</th> </tr> </thead> <tbody> <tr style="background-color: #90EE90;"> <td>Function name 1</td> <td>Open ▼</td> </tr> </tbody> </table>	Function ▲	Command	Function name 1	Open ▼
Function ▲	Command				
Function name 1	Open ▼				



Click to add an Action.



Click to create a duplicate of the Action



Click to delete the selected Action.

- ◆ **Function List** – Use this section to configure the Digital Output device functions by adding actions to the list.

**Function** – Lists the actions created for a device. Double-click to edit the Function name.

**Command** – Shows the command selected for the action. Click the drop-down menu to select an action (Open, Close, Toggle, Pulse).

## ■ Relay

General		Function List					
Brand	<input type="text"/>	Serial	IR				
Category	<input type="text"/>	DO	Relay				
Model	<input type="text"/>		Ethernet				
Version	<input type="text"/> <input type="button" value="History"/>						
Type	<input type="checkbox"/> Serial <input type="checkbox"/> IR <input type="checkbox"/> Digital Output <input checked="" type="checkbox"/> Relay <input type="checkbox"/> Ethernet						
		<div style="text-align: right;">+ <input type="button" value="Duplicate"/> <input type="button" value="Delete"/></div> <table border="1"> <thead> <tr> <th>Function ▲</th> <th>Command</th> </tr> </thead> <tbody> <tr> <td>Function name 1</td> <td>--</td> </tr> </tbody> </table>		Function ▲	Command	Function name 1	--
Function ▲	Command						
Function name 1	--						



Click to add an Action.



Click to create a duplicate of the Action



Click to delete the selected Action.

- ◆ **Function List** – Use this section to configure the Relay device functions by adding actions to the list.

**Function** – Lists the actions created for a device. Double-click to edit the Function name.

**Command** – Shows the command selected for the action. Click the drop-down menu to select an action (Open, Close, Toggle, Pulse).

*(Continues on next page.)*

## ■ Ethernet

<p><b>General</b></p> <p>Brand <input type="text"/></p> <p>Category <input type="text"/></p> <p>Model <input type="text"/></p> <p>Version <input type="text"/> <input type="button" value="History"/></p> <p>Type</p> <p><input type="checkbox"/> Serial</p> <p><input type="checkbox"/> IR</p> <p><input type="checkbox"/> Digital Output</p> <p><input type="checkbox"/> Relay</p> <p><input checked="" type="checkbox"/> Ethernet</p> <p><b>Settings</b></p> <p>Protocol <input type="text" value="TELNET"/></p> <p>Port <input type="text" value="23"/></p>	<p><b>Function List</b>    Serial   IR   DO   Relay   Ethernet</p> <p style="text-align: right;">+               </p> <table border="1"> <thead> <tr> <th>Function ▲</th> <th>Command</th> <th>Feedback</th> </tr> </thead> <tbody> <tr style="background-color: #d9ead3;"> <td>Function name 1</td> <td>Retrieve</td> <td>Send</td> </tr> </tbody> </table>	Function ▲	Command	Feedback	Function name 1	Retrieve	Send
Function ▲	Command	Feedback					
Function name 1	Retrieve	Send					



Click to add an Action.



Click to create a duplicate of the Action.



Click to add a drop menu into a Command string, then enter the number sequence in the brackets []. The **FUNCTION** name must include an Astrix (\*) for each drop menu in the Command string.



Click to add an *Enter* into the Command string.



Click to open a list of commands to add into the Command string.



Click to delete the selected action.

- ◆ **Settings** – Use the drop-down menu to select TELNET, PJLINK, ONVIF, or TCP and enter the **Port** number.
- ◆ **Function List** – Use this section to configure the device functions by adding actions to the list.

**String Format** – Use the buttons to select *HEX* or *ASCII*. (TCP only)

**Function** – Lists the actions created for a device. A Function name must include an Astrix (\*) for each drop menu you add to the Command string. Double-click to edit the function name. The drop-down menu will appear where the (\*) is entered in the Function name

**Command** – Shows the command string created for the action. Double-click to edit the string.



**Feedback** – Provides the Return Messages when the **Retrieve** and **Send** buttons are used to test the command strings (Telnet, PJLink, and TCP only).

**Retrieve** – Use to test the Command string and receive return messages from a device.

Click **Retrieve**, a pop-up window appears to select a controller. Check a box to choose a controller and enter the IP Address, Username and/or Password of the Ethernet device, then click **Select**.

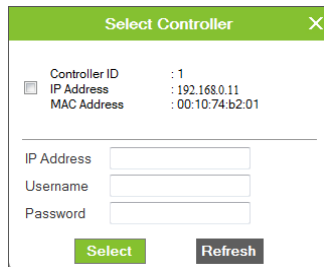

Click **Retrieve** a second time, and the **Get Feedback** window appears to send the action and receive return messages from the device:

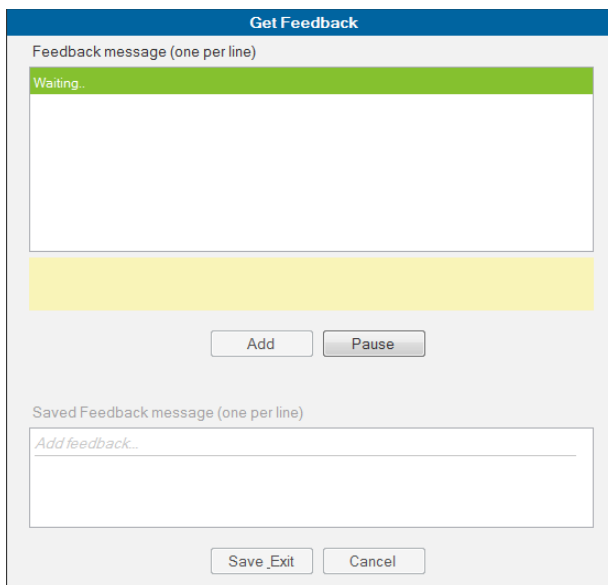

The top sections lists the Feedback message returned from the device. The bottom section lists saved Feedback messages. Once a message is received you can:

**Add** – Click to save a feedback message in the Saved Feedback message window.

**Pause / Continue** – Click to pause sending/receiving the command/ return message.

**Save Exit** – Save the Feedback Message list and exit.

**Cancel** – Exit Get Feedback without saving.

**Send** – After the string is configured click to test the action. The device must be connected to the LAN for the action test to work.

Click **Send**, a pop-up window appears to select a controller. Check a box to choose a controller and enter the IP Address, Username and/ or Password of the Ethernet device, then click **Select**.

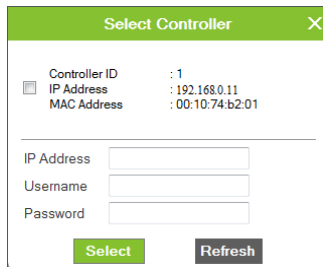

Click **Send** a second time, the **Feedback Result** window appears allowing you to select which device to send the command to. Use the radio button to choose *Send to All* or select a *drop-down menu value* (number) and click **Send**.

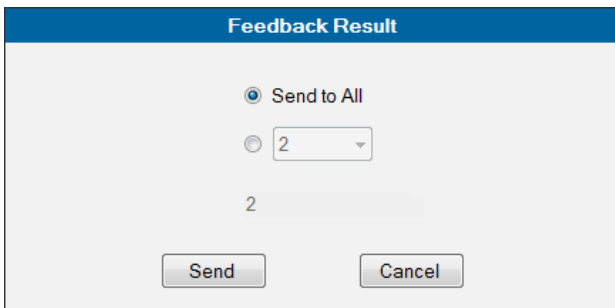

The top sections lists the Feedback message returned from the device. Once a message is received you can:

**Add** – Click to save a feedback message in the Saved Feedback message window.

**Pause / Continue** – Click to pause sending/receiving the command/return message.

**Save Exit** – Save the Feedback Message list and exit.

**Cancel** – Exit Get Feedback without saving.

## 5. Click **Save**.

## 6. The device will appear in My Library.

## ATEN Library

The *ATEN Library* provides the complete list of hardware devices in the ATEN database. You can add any device in the ATEN Library to My Library. Once a device is added to My Library, the device settings can be edited as needed.

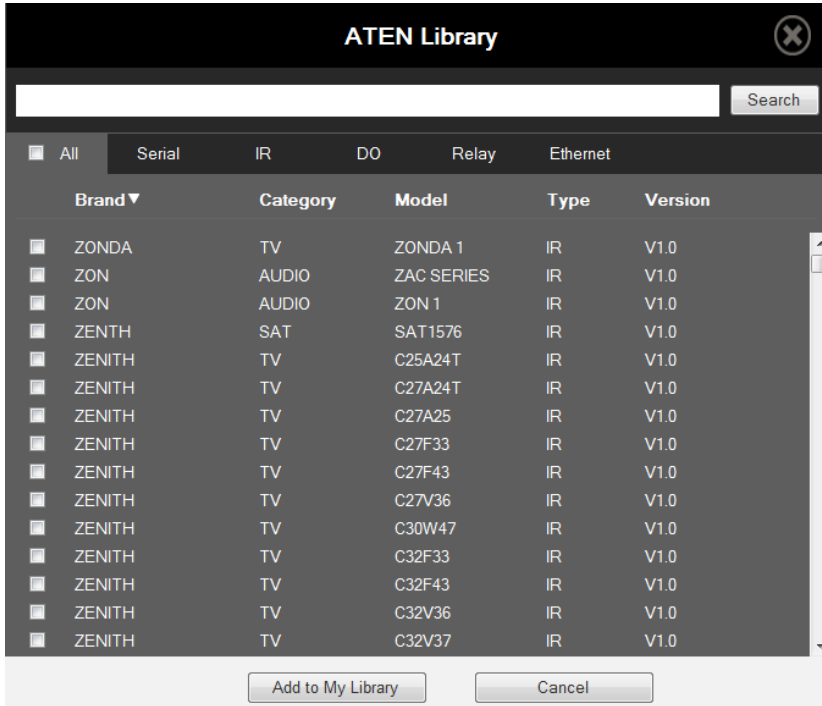

- ◆ Use the check boxes to select devices to add to My Library. Check **All** to select all devices in the list.
- ◆ Key in word strings then click **Search** to find a device.
- ◆ Click **All**, **Serial**, **DO**, **IR**, **Relay** or **Ethernet** to filter the device list by type.
- ◆ Click **Brand**, **Category**, **Model**, **Type** or **Version** to sort the devices.
- ◆ Click **Add to My Library** to add the selected devices to My Library.
- ◆ Click **Cancel** to return to My Library.

# Chapter 7

## ATEN Control System App

### Overview



---

The ATEN Control System App is a free app for mobile devices which can be downloaded from Google Play or the Apple App Store. The app allows you to download the viewer profiles from a controller. These profiles provide the interface for remote control of hardware devices.

### Installing the App

---

To install the ATEN Control System App on a mobile device, do the following:

1. From the mobile device, tap the **App Store**  or Google Play  icon.
2. In the search box, type “aten control”.
3. Tap *ATEN Control System*, then download and install the app.
4. The ATEN Control System icon  will appear on the mobile device.
5. Press the icon to open the app.

### Button Sounds

After you install the app, go to the mobile device *Settings* and find the **ATEN Control** so that you can enable/disable the *Button Sound* setting.

## ATEN Control System App

---

When you open the ATEN Control System app for the first time, the default *Welcome* screen appears:

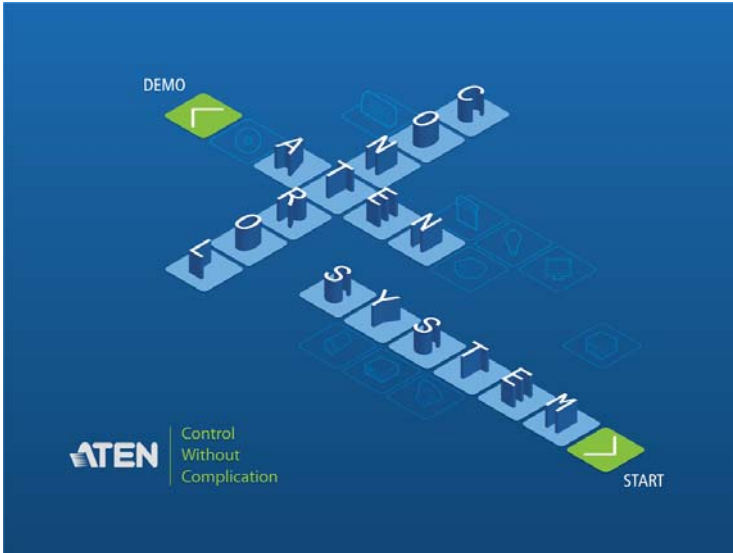

Tap **Demo** to try the ATEN Control System app. Tap **Auto Search Controller** to find a controller and download viewer profiles (see *Welcome*, page 112).

---

**Note:** The default Welcome screen only appears until a viewer profile is downloaded to the mobile device. The default Welcome screen will only reappear if the app is reinstalled, which deletes all viewer profiles.

---

## Demo

The *Demo* page provides a preview of the ATEN Control System app with two sample rooms. Tap either room to view the controls of different hardware devices. Tap **Quit Demo** at the top right corner to exit.



Tap **Room-101** or **Room-102** to select a viewer profile to demo.

## Room-101

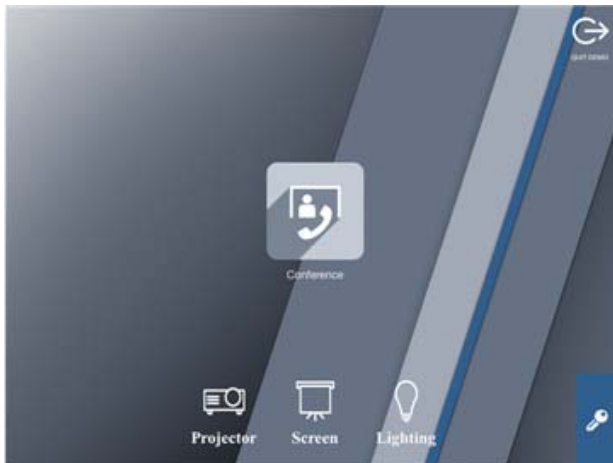

This demo shows a Conference call interface with controls for a Projector, Screen and Lighting. Tap any of the device icons to open the control page.

## Control Pages



The images above show the main page and control pages for the Projector, Screen and Lights in Room-101.

## Room-102

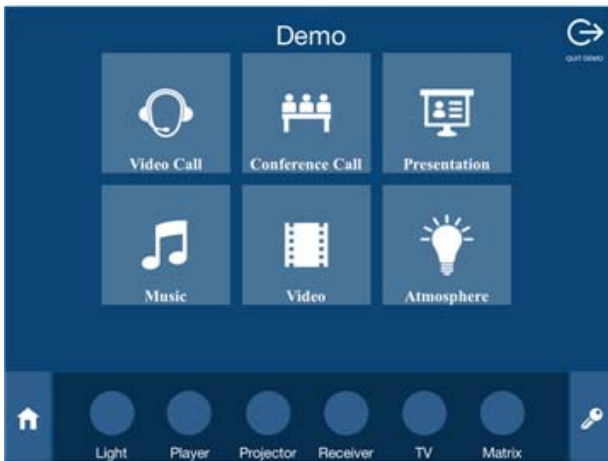

This demo shows buttons for different applications which can be pressed to start a **Video Call**, **Conference Call**, **Presentation**, etc. Tap the icons at the bottom (Light, Player, Projector, etc.) to view control pages for the different devices. Tap the **Key** icon to return to the previous page.



## Control Pages





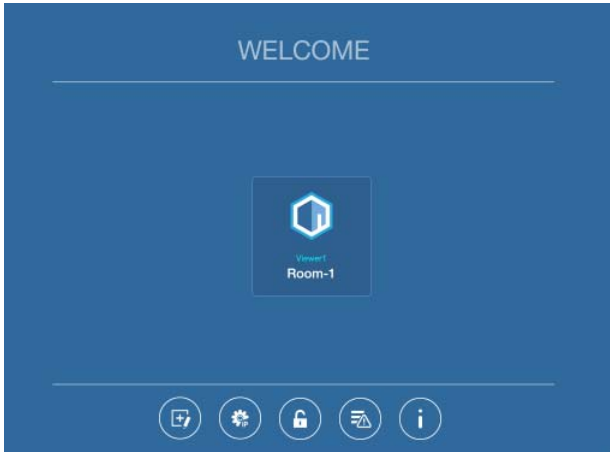

The images above show control pages for the **Light**, **Player** and **Projector** in Room-102. Tap the **Home** icon in the lower left corner to return to the previous page.

## Welcome

The *Welcome* screen is the home screen of the ATEN Control System app. It lists the viewer profiles and provides administrative options. Tap a viewer profile to open the controls for a room (see *Create Viewer & Design*, page 55), or use the administrative options listed below.





Icon	Description
	<p><b>Edit Viewer Profile</b> – This page provides options to add, update and remove viewer profiles. See page 113 for details.</p>
	<p><b>Manage IP</b> – This page provides options to configure network settings for controllers and LAN devices. See page 114 for details.</p>
	<p><b>Set Password</b> – This page provides options to set a password for access to the Welcome page when a viewer profile is in use. See page 117 for details.</p>
	<p><b>Log Report</b> – This page provides an error log to troubleshoot connectivity issues. See page 118 for details.</p>
	<p><b>Information</b> – This page provides information about the ATEN Control System's software version. See page 119 for details.</p>

## Edit Viewer Profile

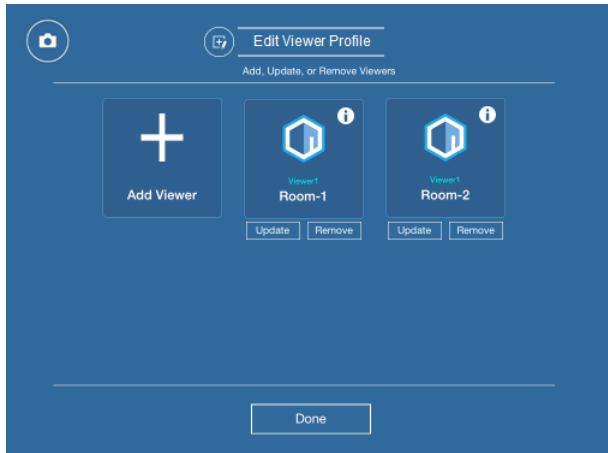
The *Edit Viewer Profile* page allows you to add, update and remove viewer profiles. To download viewer profiles, tap **Add Viewer** (see *Set Password*, page 117).



Add Viewer	Tap Add Viewer to download viewer profiles from the <i>Download Viewer Profile</i> page. See page 120 for details.
	Tap the <i>Information</i> icon to view the <b>MAC Address</b> , <b>IP Address</b> and <b>Controller ID</b> of the controller associated with the viewer profile.
Update	Tap Update to connect to the controller and download an updated version of the viewer profile. After the update, the “Downloaded Successfully” prompt will appear
Remove	Tap Remove to delete the viewer profile. A dialog box will appear to confirm deletion of the viewer profile. Tap <b>Delete</b> to remove the viewer profile*, or <b>Cancel</b> to cancel the deletion. <b>Note:</b> Viewer profiles are only deleted on the mobile device, and will still be available on the controller.
	Tap the <i>Camera</i> icon in the top left corner to change the background for the Welcome page. Select <b>Default</b> to use the default background. Tap <b>Photos</b> to select an image from the mobile device to use as a background.
Done	Tap Done to return to the Welcome page.

## Manage LAN Device

The *Manage IP* page allows you to edit network settings for the controllers and LAN devices added in the Configurator software (see *Device Library*, page 51).



Tap to expand controllers to view connected LAN devices.



Tap to open the VK2100 web GUI (see *Browser Operation*, page 27).

Depending on the LAN device you select, different options are available. Tap on a device to open the settings page. Use **Edit** to change settings, **Apply** to save or **OK** to exit.

## Controller

VK2100-ID01	<b>Edit</b>
Device IP	10.3.41.128
Router IP	Invalid IP
MAC Address	00:10:74:B2:01:99
<b>OK</b>	

VK2100-ID01	
Device IP	<input type="text" value="10.3.41.128"/>
Router IP	<input type="text" value="Enter IP with port"/>
MAC Address	00:10:74:B2:01:99
<b>Apply</b> <b>Cancel</b>	

## PJLink Projector

PJLINK		Edit
IP Address	168.192.0.2	
Port	4352	
Password	*****	
		OK

PJLINK	
IP Address	<input type="text" value="168.192.0.2"/>
Port	<input type="text" value="4352"/>
Password	<input type="password" value="*****"/>
	<input type="checkbox"/> Show Password
Apply	
Cancel	

## Telnet

TELNET		Edit
IP Address	168.192.0.3	
Port	23	
Username	User89	
Password	****	
		OK

TELNET	
IP Address	<input type="text" value="168.192.0.3"/>
Port	<input type="text" value="23"/>
Username	<input type="text" value="User89"/>
Password	<input type="password" value="****"/>
	<input type="checkbox"/> Show Password
Apply	
Cancel	

## ONVIF

ONVIF		Edit
IP Address	168.192.0.4	
Username	Admin	
Password	*****	
		OK

ONVIF	
IP Address	<input type="text" value="168.192.0.4"/>
Username	<input type="text" value="Admin"/>
Password	<input type="password" value="*****"/>
	<input type="checkbox"/> Show Password
Apply	
Cancel	

## TCP

TCP Device		Edit
IP Address	168.192.0.5	
Port	80	

---

OK

TCP Device	
IP Address	<input type="text" value="168.192.0.5"/>
Port	<input type="text" value="80"/>

---

Apply      Cancel

## Set Password

The *Set Password* page sets a password to access the Welcome page from a viewer profile. This prevents unauthorized users from changing the app settings. Users will be prompted for a password before they exit viewer profiles to access the Welcome page.

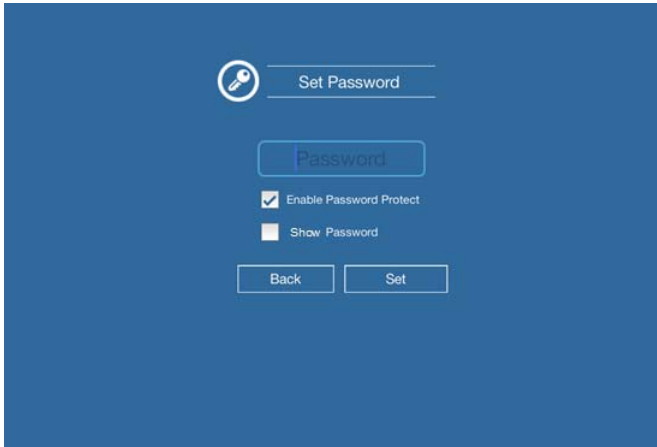

Check **Enable Password Protect**, enter a password in the box and tap **Set**. The *Show Password* option appears after you check Enable Password Protect, allowing you to display the characters typed in for the password. Tap **Back** to exit.

## Log Report

The *Log Report* page lists information and errors which can be used to troubleshoot issues. Tap and drag the list to scroll through the logs. Tap **Back** to exit. Tap **Clear** to delete the log information. Tap **Save** to save the log file.

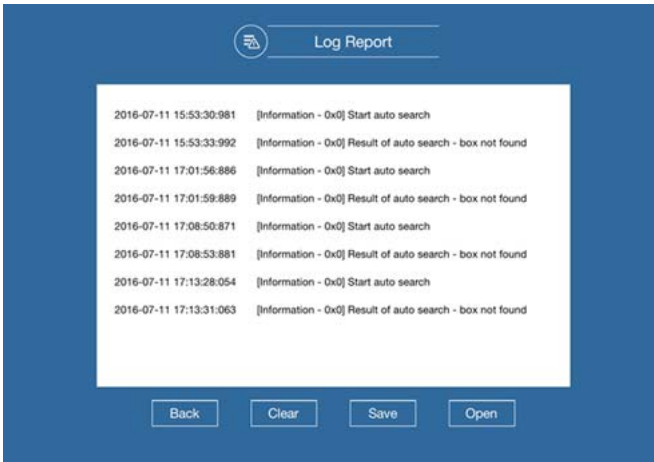

When you tap **Open**, the *Export* page opens. Saved log files are listed by date in the left column. Tap a log file to view it in the window to the right. Tap and drag the list to scroll through the logs. Tap **Export** to send the log as an e-mail attachment. Tap **Back** to exit.

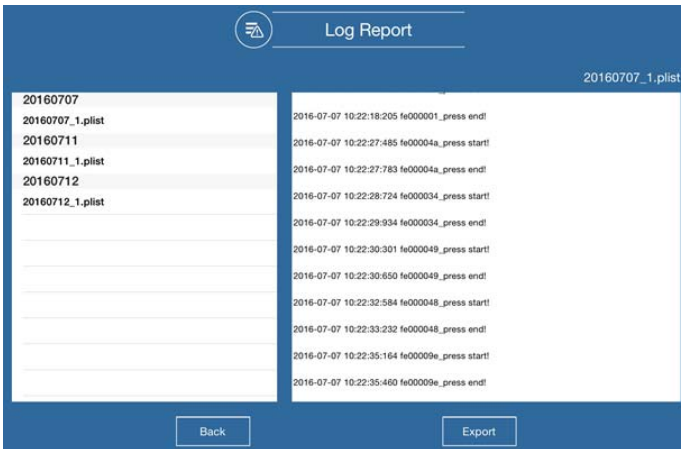



## **Information**

The *Information* page displays the ATEN Control System's version.



## Download Viewer Profile

The *Download Viewer Profile* page allows you to search for controllers and download viewer profiles. This page is accessed from *Welcome* → *Edit Viewer Profile* → **Add Viewer**.





Search Box	Tap to enter the IP address of a controller, then tap Search to find it. When controllers are found on the network, they are listed in the Add Viewer box. A <b>Search History</b> drop-down menu will appear for previously searched IP addresses.
Search	Enter the IP address of a controller then click Search to find it. The controller must be powered on and connected to the network.
Auto Search	Auto Search allows you to search for controllers without specifying an IP address. The controller must be powered on and connected to the same local network.
Add Viewer	This panel lists the controllers that have been found on the network. Each controller lists viewer profiles that can be downloaded to the mobile device. To upload viewer profiles to a controller, see <i>Search &amp; Upload</i> , page 90.
Back	Back returns you to the Welcome page.
Download	After you select the viewer profiles you want to download, click Download to start the process.

## Downloading Profiles

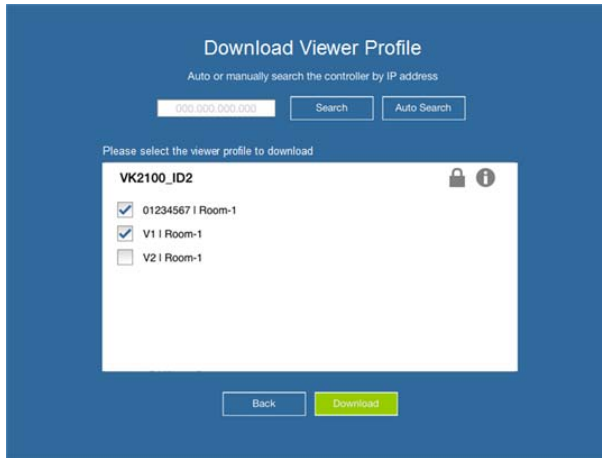
When controllers are found, they appear in the *Add Viewer* panel. Check the boxes of the viewer profiles you would like to download, then tap **Download**.



<p>Add Viewer</p>	<p>The main window lists the controllers that have been found on the network. Under each controller is a list of viewer profiles with a check box.</p> <p>Use the check boxes to select the viewer profiles you want to download, then click <b>Download</b>. If the Lock icon appears, you will be prompted to enter the access key.</p> <p>After viewer profiles download, the “Downloaded Successfully” prompt appears. Tap <b>Done</b> to return to the Welcome page where the viewer profiles will be listed.</p> <p><b>Note:</b> After you download a viewer profile to the mobile device, the default Welcome screen no longer appears.</p>
	<p>When the <i>Lock</i> icon appears, you need to enter the access key before downloading viewer profiles from the controller. To set the access key, see <i>Edit Access Key</i>, page 90.</p>
	<p>Tap the Information icon to view the <b>IP Address</b>, <b>MAC Address</b> and <b>License</b> information of the controller. The license information provides the total number of licenses available and the number in use.</p>

This Page Intentionally Left Blank

## Safety Instructions

---

### General

- ◆ Read all of these instructions. Save them for future reference.
- ◆ Follow all warnings and instructions marked on the device.
- ◆ This product is for indoor use only.
- ◆ Do not place the device on any unstable surface (cart, stand, table, etc.). If the device falls, serious damage will result.
- ◆ Caution: Risk of explosion if the battery is replaced by an incorrect type. Always dispose of used batteries according to the proper instructions.
- ◆ Do not use the device near water.
- ◆ Do not place the device near, or over, radiators or heat registers.
- ◆ The device cabinet is provided with slots and openings to allow for adequate ventilation. To ensure reliable operation, and to protect against overheating, these openings must never be blocked or covered.
- ◆ The device should never be placed on a soft surface (bed, sofa, rug, etc.) as this will block its ventilation openings. Likewise, the device should not be placed in a built in enclosure unless adequate ventilation has been provided.
- ◆ Never spill liquid of any kind on the device.
- ◆ Unplug the device from the wall outlet before cleaning. Do not use liquid or aerosol cleaners. Use a damp cloth for cleaning.
- ◆ The device should be operated from the type of power source indicated on the marking label. If you are not sure of the type of power available, consult your dealer or local power company.
- ◆ The device is designed for IT power distribution systems with 230V phase-to-phase voltage.
- ◆ To prevent damage to your installation it is important that all devices are properly grounded.
- ◆ The device is equipped with a 3-wire grounding type plug. This is a safety feature. If you are unable to insert the plug into the outlet, contact your electrician to replace your obsolete outlet. Do not attempt to defeat the purpose of the grounding-type plug. Always follow your local/national wiring codes.

- ◆ Do not allow anything to rest on the power cord or cables. Route the power cord and cables so that they cannot be stepped on or tripped over.
- ◆ If an extension cord is used with this device make sure that the total of the ampere ratings of all products used on this cord does not exceed the extension cord ampere rating. Make sure that the total of all products plugged into the wall outlet does not exceed 15 amperes.
- ◆ To help protect your system from sudden, transient increases and decreases in electrical power, use a surge suppressor, line conditioner, or un-interruptible power supply (UPS).
- ◆ Position system cables and power cables carefully; Be sure that nothing rests on any cables.
- ◆ Never push objects of any kind into or through cabinet slots. They may touch dangerous voltage points or short out parts resulting in a risk of fire or electrical shock.
- ◆ Do not attempt to service the device yourself. Refer all servicing to qualified service personnel.
- ◆ If the following conditions occur, unplug the device from the wall outlet and bring it to qualified service personnel for repair.
  - ◆ The power cord or plug has become damaged or frayed.
  - ◆ Liquid has been spilled into the device.
  - ◆ The device has been exposed to rain or water.
  - ◆ The device has been dropped, or the cabinet has been damaged.
  - ◆ The device exhibits a distinct change in performance, indicating a need for service.
  - ◆ The device does not operate normally when the operating instructions are followed.
- ◆ Only adjust those controls that are covered in the operating instructions. Improper adjustment of other controls may result in damage that will require extensive work by a qualified technician to repair.

## **Rack Mounting**

- ◆ Before working on the rack, make sure that the stabilizers are secured to the rack, extended to the floor, and that the full weight of the rack rests on the floor. Install front and side stabilizers on a single rack or front stabilizers for joined multiple racks before working on the rack.
- ◆ Always load the rack from the bottom up, and load the heaviest item in the rack first.
- ◆ Make sure that the rack is level and stable before extending a device from the rack.
- ◆ Use caution when pressing the device rail release latches and sliding a device into or out of a rack; the slide rails can pinch your fingers.
- ◆ After a device is inserted into the rack, carefully extend the rail into a locking position, and then slide the device into the rack.
- ◆ Do not overload the AC supply branch circuit that provides power to the rack. The total rack load should not exceed 80 percent of the branch circuit rating.
- ◆ Make sure that all equipment used on the rack – including power strips and other electrical connectors – is properly grounded.
- ◆ Ensure that proper airflow is provided to devices in the rack.
- ◆ Ensure that the operating ambient temperature of the rack environment does not exceed the maximum ambient temperature specified for the equipment by the manufacturer.
- ◆ Do not step on or stand on any device when servicing other devices in a rack.

## Technical Support

---

### International

- ◆ For online technical support – including troubleshooting, documentation, and software updates: **<http://eservice.aten.com>**
- ◆ For telephone support, see *Telephone Support*, page iv:

### North America

Email Support		support@aten-usa.com
Online Technical Support	Troubleshooting Documentation Software Updates	<a href="https://eservice.aten.com">https://eservice.aten.com</a>
Telephone Support		1-888-999-ATEN ext 4988

When you contact us, please have the following information ready beforehand:

- ◆ Product model number, serial number, and date of purchase.
- ◆ Your computer configuration, including operating system, revision level, expansion cards, and software.
- ◆ Any error messages displayed at the time the error occurred.
- ◆ The sequence of operations that led up to the error.
- ◆ Any other information you feel may be of help.



# Specifications

Function		VK2100
Hardware Connections		18
Interface	Serial	4 x Programmable Bi-directional RS-232/422/485 Ports (4 x DB9 Male Connectors, Configurable via Pin Assignments)  Baud Rate: 300 to 115200 (default: 9600) Data Bit: 8 (default) or 7 Stop Bit: 1 (default) or 2 Parity: None (default), Even or Odd Flow Control: None (default) RTS/CTS
		2 x Bi-directional RS-232 Ports (2 x 3-Pole Terminal Block Connectors) Baud Rate: 300 to 115200 (default: 9600) Data Bit: 8 (default) or 7 Stop Bit: 1 (default) or 2 Parity: None (default), Even or Odd
	IR/Serial	4 x Programmable IR / Uni-directional RS-232 Ports (2 x 4-Pole Terminal Block Connectors)  IR: TTL level (0 to 5 V) Carrier Frequency: 10KHz-455KHz  Serial: Uni-directional RS-232 ( + - 5 V) Baud Rate: 300 to 115200 (default: 9600) Data Bit: 8 (default) or 7 Stop Bit: 1 (default) or 2 Parity: None (default), Even or Odd
	I/O	4 x Programmable Digital Input / Output Channels (1 x 5-Pole Terminal Block Connector)  Digital Output: 250 mA sink from 12 VDC  Digital Input: VDC Mode Input Voltage Range: 0 to 24 VDC Programmable Range: 1 to 24 VDC Dry Contact Mode: Pull-up 2k ohms to + 12 VDC
	Relay	4 x Relay Channels (2 x 4-Pole Terminal Block Connector) Normally Open, Isolated Relays Contact Rating: Max 24 VDC, 2A
	VDC	4 x 12 VDC Output Ports (2 x 4-Pole Terminal Block Connectors) Power Supply: 12 VDC, 2A Max (Shared By 4 Ports)
Connectors	Ethernet	1 x RJ-45 Female, 10/100Base-T
	USB	1 x USB Type A Female (White)
	Power	1 x 3-prong AC power socket

Function		VK2100	
Switches	Controller ID	1 x 16-Segment Switch	
	Power	1 x Rocker Switch	
	Reset	1 x Semi-recessed pushbutton	
LEDs	Relay	4 (Green)	
	IR / Serial	4 (Green)	
	I/O	4 (Green)	
	Serial	RX	6 (Green)
		TX	6 (Green)
	Ethernet	Link	1 (Green)
		Act	1 (Green)
	DC Output Overload	1 (Orange)	
	IR Learn	1 (Green)	
	USB	1 (Green / Orange)	
Power	1 (Green)		
IR Receiver	1 x IR Receiver Port		
I/P Rating	100-240 VAC, 50-60 Hz		
Power Consumption	40 Watt		
Environment	Operating Temp.	0–50°C	
	Storage Temp.	-20–60°C	
	Humidity	0–80% RH, Non-condensing	
Physical Properties	Housing	Metal	
	Weight	2.64 kg	
	Dimensions (L x W x H)	43.72 x 16.32 x 4.40 cm	

## **Limited Warranty**

---

IN NO EVENT SHALL THE DIRECT VENDOR'S LIABILITY EXCEED THE PRICE PAID FOR THE PRODUCT FROM DIRECT, INDIRECT, SPECIAL, INCIDENTAL, OR CONSEQUENTIAL DAMAGES RESULTING FROM THE USE OF THE PRODUCT, DISK, OR ITS DOCUMENTATION.

The direct vendor makes no warranty or representation, expressed, implied, or statutory with respect to the contents or use of this documentation, and especially disclaims its quality, performance, merchantability, or fitness for any particular purpose.

The direct vendor also reserves the right to revise or update the device or documentation without obligation to notify any individual or entity of such revisions, or update. For further inquiries, please contact your direct vendor.