



## HDMI & VGA HDBaseT Transmitter with POH VE2812AT User Manual



[www.aten.com](http://www.aten.com)

## EMC Information

---

### FEDERAL COMMUNICATIONS COMMISSION INTERFERENCE

**STATEMENT:** This equipment has been tested and found to comply with the limits for a Class A digital device, pursuant to Part 15 of the FCC Rules. These limits are designed to provide reasonable protection against harmful interference when the equipment is operated in a commercial environment. This equipment generates, uses, and can radiate radio frequency energy and, if not installed and used in accordance with the instruction manual, may cause harmful interference to radio communications. Operation of this equipment in a residential area is likely to cause harmful interference in which case the user will be required to correct the interference at his own expense.

**FCC Caution:** Any changes or modifications not expressly approved by the party responsible for compliance could void the user's authority to operate this equipment.

**Warning:** Operation of this equipment in a residential environment could cause radio interference.

This device complies with Part 15 of the FCC Rules. Operation is subject to the following two conditions:

- (1) this device may not cause harmful interference, and
- (2) this device must accept any interference received, including interference that may cause undesired operation.

**Suggestion:** Shielded twisted pair (STP) cables must be used with the unit to ensure compliance with FCC & CE standards.

### KCC Statement

유선 제품용 / A 급 기기 (업무용 방송 통신 기기)  
이 기기는 업무용 (A 급) 전자파적합기기로서 판매자 또는 사용자는 이 점을 주의하시기 바라며, 가정 외의 지역에서 사용하는 것을 목적으로 합니다.

## RoHS

---

This product is RoHS compliant.



---

## User Information

---

### Online Registration

Be sure to register your product at our online support center:

International	<a href="http://eservice.aten.com">http://eservice.aten.com</a>
---------------	---

---

### Telephone Support

For telephone support, call this number:

International	886-2-8692-6959
China	86-400-810-0-810
Japan	81-3-5615-5811
Korea	82-2-467-6789
North America	1-888-999-ATEN ext 4988 1-949-428-1111

---

### User Notice

All information, documentation, and specifications contained in this manual are subject to change without prior notification by the manufacturer. The manufacturer makes no representations or warranties, either expressed or implied, with respect to the contents hereof and specifically disclaims any warranties as to merchantability or fitness for any particular purpose. Any of the manufacturer's software described in this manual is sold or licensed as *is*. Should the programs prove defective following their purchase, the buyer (and not the manufacturer, its distributor, or its dealer), assumes the entire cost of all necessary servicing, repair and any incidental or consequential damages resulting from any defect in the software.

The manufacturer of this system is not responsible for any radio and/or TV interference caused by unauthorized modifications to this device. It is the responsibility of the user to correct such interference.

The manufacturer is not responsible for any damage incurred in the operation of this system if the correct operational voltage setting was not selected prior to operation. PLEASE VERIFY THAT THE VOLTAGE SETTING IS CORRECT BEFORE USE.

## Package Contents

---

- ◆ 1 VE2812AT HDMI & VGA HDBaseT Transmitter with POH
- ◆ 1 RS-232 Terminal Block
- ◆ 4 Foot Pads
- ◆ 1 Power Adapter
- ◆ 1 User Instructions

---

**Note:** 1. Check to make sure that all the components are present and that nothing got damaged in shipping. If you encounter a problem, contact your dealer.

2. Read this manual thoroughly and follow the installation and operation procedures carefully to prevent any damage to the unit, and/or any of the devices connected to it.

---

# Table of Contents

---

EMC Information . . . . .	ii
RoHS . . . . .	ii
User Information . . . . .	iii
Online Registration . . . . .	iii
Telephone Support . . . . .	iii
User Notice . . . . .	iii
Package Contents . . . . .	iv
About this Manual . . . . .	vi
Conventions . . . . .	vii
Product Information . . . . .	viii

## 1. Introduction

Overview . . . . .	1
Features . . . . .	2
Planning the Installation . . . . .	3
Requirements . . . . .	3
Considerations . . . . .	3
Compatible ATEN Video Extenders . . . . .	3
Components . . . . .	4
VE2812AT Front & Rear View . . . . .	4
VE2812AT Top View . . . . .	5

## 2. Hardware Setup

Mounting the VE2812AT Unit . . . . .	7
Wall Mounting . . . . .	7
Rack Mounting . . . . .	7
Connecting the VE2812AT Unit . . . . .	8
RS-232 Channel Transmission . . . . .	10

## 3. Operation

Selecting the Input Mode . . . . .	11
Input Modes . . . . .	11
Source Switch Pushbutton . . . . .	12
RS-232 Serial Transmission . . . . .	13
Bypass . . . . .	13
Command . . . . .	13
Long Reach Mode . . . . .	15

## Appendix

Safety Instructions . . . . .	17
General . . . . .	17
Rack Mounting . . . . .	19
Technical Support . . . . .	20

International .....	20
North America .....	20
Specifications .....	21
Supported VGA Resolutions .....	23
Limited Warranty .....	24

## About this Manual

---

This user manual is provided to help you get the most from the VE2812AT unit. It covers all aspects of installation, configuration, and operation. An overview of the information found in the manual is provided below.

**Chapter 1, *Introduction*** introduces you to the HDMI & VGA HDBaseT Transmitter with POH. Its purpose, features, installation considerations, and panel components are presented and described.

**Chapter 2, *Hardware Setup*** describes the steps that are necessary to quickly and safely set up your installation.

**Chapter 3, *Operation*** explains the Long Reach Mode and limitations, and how to set up the input detection mode using the a pushbutton and RS-232 commands.

***Appendix*** provides a list of safety instructions and precautions, contact information for ATEN technical support, product specifications, and other technical information.

---

### Note:

- ◆ Read this manual thoroughly and follow the installation and operation procedures carefully to prevent any damage to the unit or any connected devices.
  - ◆ ATEN regularly updates its product documentation for new features and fixes. For an up-to-date VE2812AT documentation, visit <http://www.aten.com/global/en/>
-

## Conventions

---

This manual uses the following conventions:

- |   |  |
|---|--|
| Monospaced  | Indicates text that you should key in.   |
| [ ]   | Indicates keys you should press. For example, [Enter] means to press the <b>Enter</b> key. If keys need to be chorded, they appear together in the same bracket with a plus sign between them: [Ctrl+Alt]. |
| 1.  | Numbered lists represent procedures with sequential steps.   |
| ◆   | Bullet lists provide information, but do not involve sequential steps.   |
| →   | Indicates selecting the option (on a menu or dialog box, for example), that comes next. For example, Start → Run means to open the <i>Start</i> menu, and then select <i>Run</i> .                         |
|  | Indicates critical information.  |



## Product Information

---

For information about all ATEN products and how they can help you connect without limits, visit ATEN on the Web or contact an ATEN Authorized Reseller. Visit ATEN on the Web for a list of locations and telephone numbers:

International	<a href="http://www.aten.com">http://www.aten.com</a>
North America	<a href="http://www.aten-usa.com">http://www.aten-usa.com</a>

This Page Intentionally Left Blank

# Chapter 1

## Introduction

### Overview

---

ATEN VE2812AT is a transmitter for sending VGA (with audio) and HDMI signals up to 100 m over a single Cat 5e/6/6a or ATEN 2L-2910 Cat 6 cable. Featuring built-in PoH (Power over HDBaseT) function, the VE2812AT receives power supply from the HDBaseT output port on the connected device. This eliminates the need for a power adapter and reduces the hassle of power line deployment behind the wall. The VE2812AT guarantees reliable transmission of HDMI signals, supporting 3D, Deep Color, and embedded HD lossless audio formats. It also ensures transmission of VGA (with audio) at distance up to 100 m. In addition, it supports Long Reach Mode up to 150 m via a single Cat 5e/6 cable at resolutions up to 1080p.

For utility flexibility, the VE2812AT can serve as a video switch by connecting two sources and distribute them to an identical output. The VE2812AT is recommended to be deployed in paired with the VE2812R. The VE2812R can carry on IR/RS-232 from the VE2812R to the VE2812AT, allowing users to remotely control the VE2812AT unit through RS-232 command mode via input port switching. The solution is ideal for a variety of settings, such as meeting rooms, digital educational environment or where high video quality is required.

## Features

---

- ◆ Extends HDMI or VGA signals, providing superior video quality:
  - ◆ HDMI: 4K / 1080p at distance up to 100 m via a Cat 5e/6/6a or ATEN 2L-2910 Cat 6 cable
  - ◆ VGA: 1600 x 1200 and 1920 x 1200 up to 100 m via a Cat 5e/6/6a or ATEN 2L-2910 Cat 6 cable
- ◆ HDMI (3D, Deep color, 4K); HDCP compatible
- ◆ Supports HDBaseT Long Reach Mode – up to 150 m via a single Cat 5e/6 cable at resolutions up to 1080p
- ◆ Built-in PoH (Power over HDBaseT) function – the VE2812AT receives power supply from the HDBaseT output port on the connected device
- ◆ Supports Auto Switch – the VE2812AT automatically switches to a newly plugged-in source
- ◆ Functions as a switch or a converter:
  - ◆ A Switch: Connects two sources (HDMI or VGA)
  - ◆ A converter: Applies receivers with different interface (DVI, DisplayPort, or HDMI)
- ◆ RS-232 Channel Transmission – allows you to connect to serial terminals or serial devices, such as touch screens and barcode scanners
- ◆ Plug-and-play with no software installation required
- ◆ Rack mountable
- ◆ Built- in 8KV / 15 KV ESD protection

## Planning the Installation

### Requirements

Prepare the following before installing the VE2812AT unit:

- ◆ 1 HDMI and/or VGA source device
- ◆ 1 Cat 5e/6/6a or ATEN 2L-2910 Cat 6 cable

### Considerations

- ◆ To ensure video quality, ATEN recommends using a Cat 5e/6/6a cable.

---

**Note:** For best results, ATEN recommends using the ATEN 2L-2910 Cat 6 cable.

---

- ◆ The maximum transmission distance varies at different parts of the transmission:

Connection	Interface	Distance
Computer to the VE2812AT	HDMI	1.8 m
The VE2812AT to a compatible ATEN Video Extender	Cat 5e/6/6a	100 m / 150 m (up to 1080p in Long Reach Mode)
A compatible ATEN Video Extender to the display	HDMI	5 m

### Compatible ATEN Video Extenders

The VE2812AT is designed to work with a wide range of ATEN HDBaseT video extenders. Visit our official web site for more details.

## Components

### VE2812AT Front & Rear View

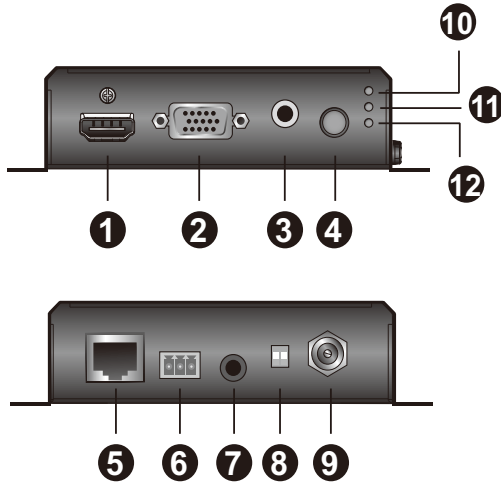

No.	Component	Description
1	HDMI Input Port	Connects to the HDMI Out port on the source device.
2	VGA Input Port	Connects to the VGA Out port on the source device.
3	Audio Input	Connects to the Audio Out port on the source device.
4	Source Switch Pushbutton	Press to switch among the Auto Switch, HDMI, and VGA input mode. The input mode status is indicated by the three LEDs to the right of this pushbutton. For details, see <i>VE2812AT Top View</i> , page 5. To switch between Bypass Mode and Command mode, see <i>RS-232 Serial Transmission</i> , page 13.
5	HDBaseT Output Port	Connects to the HDBaseT Output port on a compatible ATEN video receiver via an RJ-45 cable.
6	RS-232 Port	Connects to an RS-232 main controller, such as a PC or Control system.
7	IR Port	Connects to an IR transmitter/receiver.
8	HDBaseT Long Reach Mode Switch / Firmware Upgrade Switch	Put the switch to <b>ON</b> to enable the Long Reach Mode. For more details on Long Reach Mode, see <i>Long Reach Mode</i> , page 15. The firmware upgrade switch is reserved for ATEN Technical Support. If you would like do a firmware upgrade yourself, please contact your dealer.

No.	Component	Description
9	Power Jack	Connects to the Power Adapter.
10	Auto LED	Lights orange when the unit is set to the Auto Switch mode. For details, see <i>Selecting the Input Mode</i> , page 11.
11	HDMI LED	Lights orange when the unit is set to transmit HDMI input.
12	VGA LED	Lights orange when the unit is set to transmit VGA input.

## VE2812AT Top View

You can find the unit's LEDs on the top and front panel as illustrated below. See the table below for details on LED indication.

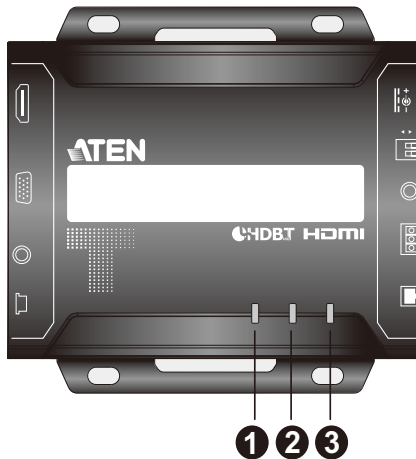

No.	LED	Indication	Description
1	HDMI/VGA In Status LED	Lights orange	The HDMI signal is stable.
		Lights green	The VGA signal is stable.
2	Link LED	Lights orange	The transmission to the receiver is stable.
		Blinks orange	The transmission to the receiver is unstable.
3	Power LED	Lights green	The unit is receiving power.

### Note:

- ◆ The Power and Link LED blink at the same time to indicate that the firmware upgrade is in progress.
- ◆ Auto Switch Mode LED, HDMI Mode LED, and VGA Mode LED light and blink at the same time to indicate that the RS-232 mode is changed.

This Page Intentionally Left Blank



# Chapter 2

## Hardware Setup



1. Please review the safety information regarding the placement of this device in *Safety Instructions*, page 17.
2. Do not power on the VE2812AT until all the necessary hardware is connected.

### **Mounting the VE2812AT Unit**

---

You can mount the VE2812AT to the wall or on a rack.

#### **Wall Mounting**

Secure or hang the VE2812AT unit to the wall using the built-in mounting brackets.

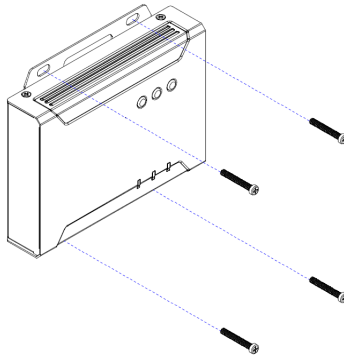

#### **Rack Mounting**

Use the VE-RMK 1U Rack Mount Kit to rack-mount the VE2812AT. For more information about this accessory, go to [www.aten.com/products](http://www.aten.com/products)

## Connecting the VE2812AT Unit

---

Follow the steps below to connect the VE2812AT to a source, a compatible ATEN Video Extender, and other controls as required.

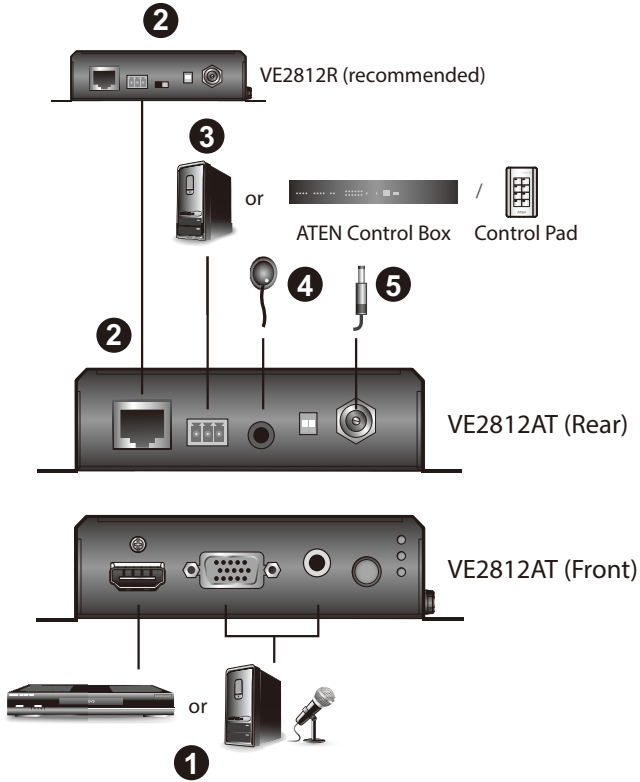

1. Connect the HDMI Input Port on the VE2812AT to the HDMI or VGA Output port on your video source device using an HDMI or VGA cable. If VGA cable is connected, then you need to connect the VGA audio jack to the Audio Input on the VE2812AT to transmit sound.

2. Connect one end of the RJ-45 cable to the HDBaseT Output port on the transmitter. Then connect the other end of the RJ-45 cable to the HDBaseT input port on the receiver for transmission and power supply.

---

**Note:** This HDBaseT output port is PoH PD ready, therefore you can connect the PoH PSE ready device such as VP1421 for power delivery, and there is no need to plug power adapter to the VE2812AT.

---

3. (Optional) Connect your computer or a control system to the terminal block on the VE2812AT. The RS-232 Serial Port supports Command Mode and Bypass Mode, see *RS-232 Serial Transmission*, page 13.
  - ♦ To control the VE2812R using an ATEN Control System/Control Pad, connect a Control Box/Control Pad to the VE2812AT's RS-232 Serial port and then put the RS-232 Serial Communication Switch to **Command**.

---

**Note:** By default, the VE2812AT is set to **Command** mode.

---

- ♦ To bypass RS-232 serial control signals to a PC or a serial device, connect the PC or serial device (e.g. touch pad) to the VE2812AT's RS-232 Serial port and put the RS-232 Serial Communication Switch to Bypass.
4. (Optional) To receive IR signals to remotely control a device (e.g. blu-ray disc) connected to the video receiver, connect an IR emitter to the VE2812AT's IR Port and an IR receiver to the VE2812R's IR Port or vice versa.

---

**Note:** To purchase an IR emitter and an IR remote control, contact your local sales representative for more information.

---

5. (Optional) Plug the power adapter cable into the Power Jack for additional power supply.

---

**Note:** The VE2812AT prioritizes the power supply from the power adapter when the Power Adapter is plugged in.

---

## RS-232 Channel Transmission

---

You can manage the VE2812AT via RS-232 serial devices, such as computers or bar code scanners. The RS-232 signal transmission flow can be illustrated as follows:

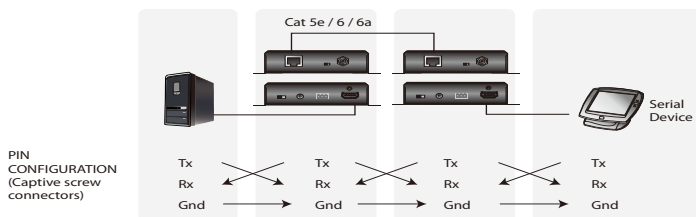

From a source device, the RS-232 signal is transmitted (Tx) to the VE2812AT receiving (Rx) unit; the a compatible ATEN Video Receiver transmits (Tx) signals to the display device (Rx).

You can set the VE2812AT to either bypass serial data or to receive RS-232 commands. By default, the VE2812AT is set to receive serial data. To set the unit to bypass RS-232 commands, press the Input Switch pushbutton for 3 seconds. For details on RS-232 commands, see *RS-232 Serial Transmission*, page 13.

# Chapter 3

## Operation

### Selecting the Input Mode

---

#### Input Modes

You can switch among different input modes based on your needs. Refer to the table below for how each mode works.

Input Mode	Description
Auto Switch (LED lights orange)	<ul style="list-style-type: none"><li>◆ Before power on, the VE2812AT prioritizes HDMI transmission if both HDMI and VGA inputs are plugged in at the same time.</li><li>◆ After power on, the VE2812AT prioritizes the latest detected input source transmission to the connected receiver.</li></ul> <p><b>Note:</b> You can disable this part of the Auto Switch mode (automatic input switching) using an RS-232 command. For more details, see <i>Press the Source Switch Pushbutton located on the front panel to switch among the Auto Switch, HDMI, and VGA input mode.</i>, page 12.</p>
HDMI (LED lights orange)	The VE2812AT only transmits HDMI source to the connected receiver.
VGA (LED lights orange)	The VE2812AT only transmits VGA source and its audio input to the connected receiver.

## **Source Switch Pushbutton**

Press the **Source Switch Pushbutton** located on the front panel to switch among the Auto Switch, HDMI, and VGA input mode.

**VE2812AT Front Panel**

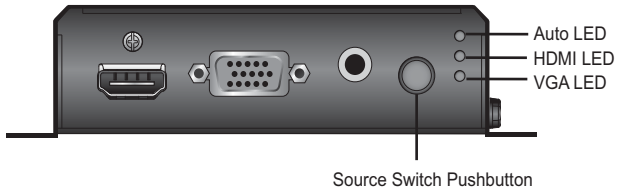

## RS-232 Serial Transmission

The RS-232 Serial Transmission allows you to choose whether to bypass serial data or to remotely control the VE2812AT using commands depending on your installation.

To switch the VE2812AT RS-232 mode, do the following:

1. Press the Source Switch Pushbutton for 3 seconds as shown in the diagram below.

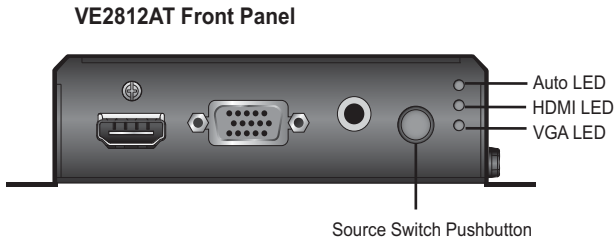

- ◆ Bypass mode: the Auto LED, HDMI LED, and VGA LED light orange and blink once per second for three seconds.
- ◆ **Command mode:** the Auto LED, HDMI LED, and VGA LED light orange and blink once every 0.3 seconds for three seconds.

---

**Note:** 1. By default, the VE2812AT is set to **Command** mode.

2. The RS-232 status is kept even VE2812AT is powered on and off.  
For detailed LEDs behavior, see *VE2812AT Top View*, page 5.

---

### Bypass

RE-232 serial data is bypassed from the controller PC or Pad to other connected devices.

### Command

You can change the input mode using RS-232 commands. Refer to the table below for a list of available tasks and the corresponding commands.

Type the corresponding command to execute a task. For example, to enable automatic switching, type **swmode next** and then press **[Enter]**.

Task	Command		
	Control	Input	Port
Enable automatic input switching	swmode plugin auto	N/A	N/A
Disable automatic input switching	swmode plugin off	N/A	N/A
Enable automatic plug-out switching	swmode plugout prev	N/A	N/A
Disable automatic plug-out switching	swmode plugout off	N/A	N/A
Set the unit to the HDMI mode	sw	i	01
Set the unit to the VGA mode	sw	i	02
View the current input mode settings	read	N/A	N/A

**Note:**

- ◆ Press **[Enter]** to execute a command.
  - ◆ The current input mode setting is also indicated by the Auto Switch, HDMI, and VGA LEDs.
  - ◆ The automatic plug-out switching is enabled by default.
-



---

## Long Reach Mode

---

Long Reach Mode is a modulation that extends the transmission distance up to 150 m using a Cat 5e/6 cable while compromising the maximum frame rate to 1080p, 24 bpp, 60 Hz via a single Cat 5e/6 cable. To enable Long Reach Mode, put the HDBaseT Long Reach Mode Switch to **ON** at either the transmitter or the connected receiver.

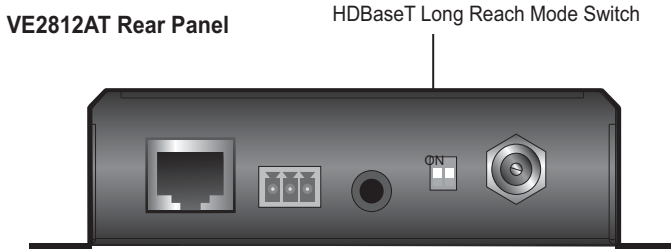

---

**Note:** When Long Reach Mode is enabled, the VE2812AT will not be able to transmit 4K signals, in which case, the output display will be blank.

---

This Page Intentionally Left Blank

## Safety Instructions

---

### General

- ◆ This product is for indoor use only.
- ◆ Read all of these instructions. Save them for future reference.
- ◆ Follow all warnings and instructions marked on the device.
- ◆ Do not place the device on any unstable surface (cart, stand, table, etc.). If the device falls, serious damage will result.
- ◆ Do not use the device near water.
- ◆ Do not place the device near, or over, radiators or heat registers.
- ◆ The device cabinet is provided with slots and openings to allow for adequate ventilation. To ensure reliable operation, and to protect against overheating, these openings must never be blocked or covered.
- ◆ The device should never be placed on a soft surface (bed, sofa, rug, etc.) as this will block its ventilation openings. Likewise, the device should not be placed in a built in enclosure unless adequate ventilation has been provided.
- ◆ Never spill liquid of any kind on the device.
- ◆ Unplug the device from the wall outlet before cleaning. Do not use liquid or aerosol cleaners. Use a damp cloth for cleaning.
- ◆ The device should be operated from the type of power source indicated on the marking label. If you are not sure of the type of power available, consult your dealer or local power company.
- ◆ The device is designed for IT power distribution systems with 230V phase-to-phase voltage.
- ◆ To prevent damage to your installation it is important that all devices are properly grounded.
- ◆ The device is equipped with a 3-wire grounding type plug. This is a safety feature. If you are unable to insert the plug into the outlet, contact your electrician to replace your obsolete outlet. Do not attempt to defeat the purpose of the grounding-type plug. Always follow your local/national wiring codes.
- ◆ Do not allow anything to rest on the power cord or cables. Route the power cord and cables so that they cannot be stepped on or tripped over.

- ◆ If an extension cord is used with this device make sure that the total of the ampere ratings of all products used on this cord does not exceed the extension cord ampere rating. Make sure that the total of all products plugged into the wall outlet does not exceed 15 amperes.
- ◆ To help protect your system from sudden, transient increases and decreases in electrical power, use a surge suppressor, line conditioner, or uninterruptible power supply (UPS).
- ◆ Position system cables and power cables carefully; Be sure that nothing rests on any cables.
- ◆ Never push objects of any kind into or through cabinet slots. They may touch dangerous voltage points or short out parts resulting in a risk of fire or electrical shock.
- ◆ Do not attempt to service the device yourself. Refer all servicing to qualified service personnel.
- ◆ If the following conditions occur, unplug the device from the wall outlet and bring it to qualified service personnel for repair.
  - ◆ The power cord or plug has become damaged or frayed.
  - ◆ Liquid has been spilled into the device.
  - ◆ The device has been exposed to rain or water.
  - ◆ The device has been dropped, or the cabinet has been damaged.
  - ◆ The device exhibits a distinct change in performance, indicating a need for service.
  - ◆ The device does not operate normally when the operating instructions are followed.
- ◆ Only adjust those controls that are covered in the operating instructions. Improper adjustment of other controls may result in damage that will require extensive work by a qualified technician to repair.

## **Rack Mounting**

- ◆ Before working on the rack, make sure that the stabilizers are secured to the rack, extended to the floor, and that the full weight of the rack rests on the floor. Install front and side stabilizers on a single rack or front stabilizers for joined multiple racks before working on the rack.
- ◆ Always load the rack from the bottom up, and load the heaviest item in the rack first.
- ◆ Make sure that the rack is level and stable before extending a device from the rack.
- ◆ Use caution when pressing the device rail release latches and sliding a device into or out of a rack; the slide rails can pinch your fingers.
- ◆ After a device is inserted into the rack, carefully extend the rail into a locking position, and then slide the device into the rack.
- ◆ Do not overload the AC supply branch circuit that provides power to the rack. The total rack load should not exceed 80 percent of the branch circuit rating.
- ◆ Make sure that all equipment used on the rack – including power strips and other electrical connectors – is properly grounded.
- ◆ Ensure that proper airflow is provided to devices in the rack.
- ◆ Ensure that the operating ambient temperature of the rack environment does not exceed the maximum ambient temperature specified for the equipment by the manufacturer.
- ◆ Do not step on or stand on any device when servicing other devices in a rack.

## Technical Support

---

### International

- ◆ For online technical support – including troubleshooting, documentation, and software updates: <http://support.aten.com>
- ◆ For telephone support, see *Telephone Support*, page iii:

### North America

Email Support		<a href="mailto:support@aten-usa.com">support@aten-usa.com</a>
Online Technical Support	Troubleshooting Documentation Software Updates	<a href="http://www.aten-usa.com/support">http://www.aten-usa.com/support</a>
Telephone Support		1-888-999-ATEN ext 4988

When you contact us, please have the following information ready beforehand:

- ◆ Product model number, serial number, and date of purchase
- ◆ Your computer configuration, including operating system, revision level, expansion cards, and software
- ◆ Any error messages displayed at the time the error occurred
- ◆ The sequence of operations that led up to the error
- ◆ Any other information you feel may be of help

## Specifications

Function	VE2812AT
<b>Video Input</b>	
Interfaces	1 x HDMI Type A Female (Black) 1 x HDB-15 (VGA) Male (Blue)
Impedance	HDMI: 100 $\Omega$ HDB-15 (VGA): 75 $\Omega$
Max. Distance	1.8 m
<b>Video Output</b>	
Max. Data Rate	10.2 Gbps (3.4 Gbps per lane)
Max. Pixel Clock	340 MHz
Compliance	HDMI (3D, Deep Color, 4K)
	HDCP Compatible
	Consumer Electronics Control (CEC)
Max. Resolutions / Distances	<p>HDMI:</p> <ul style="list-style-type: none"> <li>◆ Up to 4k @70m (Cat 5e/6) / 100m (Cat 6a/ATEN 2L-2910 Cat6)</li> <li>◆ Up to 1080p @100m (Cat 5e/6/6a)</li> </ul> <p>VGA:</p> <ul style="list-style-type: none"> <li>◆ Up to 1920 x 1200 &amp; 1600 x 1200 @70m (Cat 5e/6) / 100m (Cat 6a/ATEN 2L-2910 Cat 6)</li> <li>◆ Up to 1920 x 1080 @100m (Cat 5e/6/6a)</li> </ul> <p>4k supported:</p> <ul style="list-style-type: none"> <li>◆ 4096 x 2160 / 3840 x 2160 @60Hz (4:2:0)</li> <li>◆ 4096 x 2160 / 3840 x 2160 @30Hz (4:4:4)</li> </ul>
<b>Audio</b>	
Input	1 x HDMI Type A Female (Black) 1 x Mini Stereo Jack Female (Green)
<b>Connectors</b>	
Unit To Unit	1 x RJ-45 Female
Power	1 x DC Jack (Black) with locking or, 1 x RJ-45 Female (PoE)
<b>Control</b>	

Function		VE2812AT
RS-232	Connector	1 x Terminal Block, 3 Pole; Type: DTE
	Baud Rate	19200
	Data Bits	8
	Stop Bits	1, no parity and flow control
IR		1 x Mini Stereo Jack Female (Black)
<b>Switches</b>		
Video Input Port Selection		1 x Pushbutton - HDMI, VGA, and AUTO
Long Reach Mode Switch		1 Slide Switch - ON/OFF
Firmware Upgrade		1 Slide Switch - ON/OFF
<b>Power</b>		
Consumption		DC 5V; 3.14W; 15BTU DC48V; 3.93W; 18BTU
<b>Environmental</b>		
Operating Temperature		0 - 40°C
Storage Temperature		-20 - 60°C
Humidity		0 x 80% RH, Non-Condensing
<b>Physical Properties</b>		
Housing		Metal
Weight		0.47 Kg (1.04 lb)
Dimensions (L x W x H) with Bracket		14.32 x 12.30 x 3.00 cm (5.64 x 4.84 x 1.18 in.)
Dimensions (L x W x H) without Bracket		13.60 x 10.10 x 2.90 cm (5.35 x 3.98 x 1.14 in.)



---

## Supported VGA Resolutions

---

The VE2812AT supports the following VGA resolutions:

VGA Resolution	Frame Rate (Hz)
640 x 480	60
640 x 480	75
800 x 600	60
800 x 600	75
1024 x 768	60
1024 x 768	75
1152 x 564	60
1152 x 564	75
1280 x 600	60
1280 x 720	60
1280 x 768	60
1280 x 800	60
1280 x 800	75
1280 x 960	60
1280 x 1024	60
1280 x 1024	75
1360 x 768	60
1366 x 768	60
1400 x 1050	60
1440 x 900	60
1600 x 900	60
1600 x 1200	60
1680 x 1050	60
1920 x 1080	60

---

## Limited Warranty

---

ATEN warrants its hardware in the country of purchase against flaws in materials and workmanship for a Warranty Period of two [2] years (warranty period may vary in certain regions/countries) commencing on the date of original purchase. This warranty period includes the LCD panel of ATEN LCD KVM switches. Select products are warranted for an additional year (see *A+ Warranty* for further details). Cables and accessories are not covered by the Standard Warranty.

### **What is covered by the Limited Hardware Warranty**

ATEN will provide a repair service, without charge, during the Warranty Period. If a product is defective, ATEN will, at its discretion, have the option to (1) repair said product with new or repaired components, or (2) replace the entire product with an identical product or with a similar product which fulfills the same function as the defective product. Replaced products assume the warranty of the original product for the remaining period or a period of 90 days, whichever is longer. When the products or components are replaced, the replacing articles shall become customer property and the replaced articles shall become the property of ATEN.

To learn more about our warranty policies, please visit our website:  
<http://www.aten.com/global/en/legal/policies/warranty-policy>