



4 x 2 True 4K Presentation Matrix Switch

VP1420 / VP1421 User Manual



EMC Information

FEDERAL COMMUNICATIONS COMMISSION INTERFERENCE

STATEMENT: This equipment has been tested and found to comply with the limits for a Class A digital device, pursuant to Part 15 of the FCC Rules. These limits are designed to provide reasonable protection against harmful interference when the equipment is operated in a commercial environment. This equipment generates, uses, and can radiate radio frequency energy and, if not installed and used in accordance with the instruction manual, may cause harmful interference to radio communications. Operation of this equipment in a residential area is likely to cause harmful interference in which case the user will be required to correct the interference at his own expense.

FCC Caution: Any changes or modifications not expressly approved by the party responsible for compliance could void the user's authority to operate this equipment.

Warning: Operation of this equipment in a residential environment could cause radio interference.

This device complies with Part 15 of the FCC Rules. Operation is subject to the following two conditions:

- (1) this device may not cause harmful interference, and
- (2) this device must accept any interference received, including interference that may cause undesired operation.

Suggestion: Shielded twisted pair (STP) cables must be used with the unit to ensure compliance with FCC & CE standards.

RoHS

This product is RoHS compliant.



User Information

Online Registration

Be sure to register your product at our online support center:

International	http://eservice.aten.com
---------------	---

Telephone Support

For telephone support, call this number:

International	886-2-8692-6959
China	86-400-810-0-810
Japan	81-3-5615-5811
Korea	82-2-467-6789
North America	1-888-999-ATEN ext 4988 1-949-428-1111

User Notice

All information, documentation, and specifications contained in this manual are subject to change without prior notification by the manufacturer. The manufacturer makes no representations or warranties, either expressed or implied, with respect to the contents hereof and specifically disclaims any warranties as to merchantability or fitness for any particular purpose. Any of the manufacturer's software described in this manual is sold or licensed as *is*. Should the programs prove defective following their purchase, the buyer (and not the manufacturer, its distributor, or its dealer), assumes the entire cost of all necessary servicing, repair and any incidental or consequential damages resulting from any defect in the software.

The manufacturer of this system is not responsible for any radio and/or TV interference caused by unauthorized modifications to this device. It is the responsibility of the user to correct such interference.

The manufacturer is not responsible for any damage incurred in the operation of this system if the correct operational voltage setting was not selected prior to operation. PLEASE VERIFY THAT THE VOLTAGE SETTING IS CORRECT BEFORE USE.

Package Contents

Make sure that all of the items are present and in good order. If anything is missing or was damaged in shipping, please contact your dealer for further assistance.

VP1420

- ◆ 1 VP1420 4 x 2 True 4K Presentation Matrix Switch
- ◆ 1 IR Receiver
- ◆ 1 IR Remote Control
- ◆ 2 3-pole Terminal Blocks
- ◆ 2 5-pole Terminal Blocks
- ◆ 1 Power Adapter
- ◆ 1 User Instructions

VP1421

- ◆ 1 VP1421 4 x 2 True 4K Presentation Matrix Switch with Scaling, DSP, and HDBaseT-Lite
- ◆ 1 IR Receiver
- ◆ 1 IR Remote Control
- ◆ 4 3-pole Terminal Blocks
- ◆ 2 5-pole Terminal Blocks
- ◆ 1 Power Adapter
- ◆ 1 User Instructions

VPK104

- ◆ 1 VPK104 4-Key Contact Closure Remote Pad
- ◆ 4 4-Pole Terminal Blocks
- ◆ 1 User Instructions

Table of Contents

EMC Information	ii
RoHS	ii
User Information	iii
Online Registration	iii
Telephone Support	iii
User Notice	iii
Package Contents	iv
VP1420	iv
VP1421	iv
VPK104	iv
About this Manual	ix
Conventions	x
Product Information	x

1. Introduction

Overview	1
Features	2
VP1420	2
VP1421	4
Planning the Installation	6
Required Equipment	6
VP1420	6
VP1421	6
Optional Equipment	7
VP1420	7
VP1421	7

2. Hardware Setup

Hardware Overview	9
VP1420	9
Front View	9
Rear View	10
VP1421	11
Front View	11
Rear View	12
IR Remote Control	14
VPK104	15
Front View	15
Rear View	16
Side View	16
Mounting	17
Rack Mount	17
Under Desk Mount	18

Installation	19
VP1420	19
VP1421	21
VPK104	23
3. Local Operation	
Overview	25
Operation Considerations	25
Switching Sources	25
Display Mode	26
Understanding Display Mode	26
Configuration	26
Audio Settings	27
Panel Lock	28
Power LED Indication	29
4. Remote Operation	
Overview	31
Default Network and Login Settings	31
Supported Web Browsers	32
Logging In the Web Console	33
The Main Screen	34
General Settings	35
Audio & Video Settings	38
Audio Control	38
Audio Output	39
Audio Input (VP1420)	39
Audio Input (VP1421)	40
Apply vs. Auto Apply	40
Video Control	41
Apply vs. Auto Apply	42
System Settings	43
Maintenance	43
Upgrading the System Firmware	43
Backing Up System Settings	44
Restoring System Settings	44
Resetting the Default Settings	44
Network Settings	45
IP Settings	45
Browser	45
5. CLI Commands	
Overview	47
Connecting to the VP1420 / VP1421 via Telnet	47
Connecting to the VP1420 / VP1421 via RS-232	48
Command Syntax	49

Command List	50
Port Numbers	50
cec	50
displaymode	51
echo	51
edid	52
mute	52
power	53
read	53
reset	54
scaling	54
standby	54
sw	55
swmode	55
volume	56

6. Video Presentation Control App

Overview	57
Installing and Configuring the App	57
iOS Version	58
Main Page	58
Info	59
Logging in to the Control Panel	60
Logging in to the Control Panel Automatically	60
Logging in to the Control Panel via Manually Connect	62
Leaving the Meeting	65
Enabling Standby Mode	66
Checking the Firmware Version	67
Video Panel	68
Switching a Source for a Display	68
Display A Settings	69
Display B Settings	71
Audio Panel	72
VP1420 Audio Output Settings	72
VP1421 Audio Output Settings	72
VP1420 Audio Input Settings	74
VP1421 Audio Input Settings	74
Android Version 78	
Main Page	78
Info	79
Logging in to the Control Panel	80
Logging in to the Control Panel Automatically	80
Logging in to the Control Panel via Manually Connect	82
Leaving the Meeting	85
Enabling Standby Mode	86

Checking the Firmware Version	87
Video Panel	88
Switching a Source for a Display	88
Display A Settings	89
Auto Switching	90
Display B Settings	90
Audio Panel	92
VP1420 Audio Output Settings	92
VP1421 Audio Output Settings	92
VP1420 Audio Input Settings	94
VP1421 Audio Input Settings	94

Appendix

Safety Instructions	99
General	99
Rack Mounting	101
Technical Support	102
International	102
North America	102
Specifications	103
VP1420	103
VP1421	105
Limited Warranty 108 Limited Warranty	106

About this Manual

This user manual is provided to help you get the most from the 4 x 2 True 4K Presentation Matrix Switch and Remote Pad. It covers all aspects of installation, configuration, and operation for the following models:

Device Type	Device Model	Device Name
Presentation Switch	VP1420	4 x 2 True 4K Presentation Matrix Switch
	VP1421	4 x 2 True 4K Presentation Matrix Switch with Scaling, DSP, and HDBaseT-Lite
Remote Pad	VPK104	4-Key Contact Closure Remote Pad

Chapter 1, *Introduction* introduces you to the VP1420 / VP1421. Its purpose, features, benefits, and installation considerations are described.

Chapter 2, *Hardware Setup* introduces the panel components of the 4 x 2 True 4K Presentation Matrix Switch and the IR Remote Control, and details the steps to quickly and safely install the VP1420 / VP1421.

Chapter 3, *Local Operation* provides information on how to locally operate and access the system settings via the panel pushbuttons and IR remote control.

Chapter 4, *Remote Operation* provides details on remote management and control tasks via the system web interface.

Chapter 5, *CLI Commands* provides details on the functions and RS-232 commands that you can use to control the VP1420 / VP1421 using a serial controller.

Chapter 6, *Video Presentation Control App* provides details on remotely configuring system settings via the ATEN Video Presentation Control App.

Appendix provides a list of safety instructions and precautions, contact information for ATEN technical support, product specifications, and other technical information.

Note:

- ♦ Read this manual thoroughly and follow the installation and operation procedures carefully to prevent any damage to the unit or any connected devices.
 - ♦ ATEN regularly updates its product documentation for new features and fixes. For an up-to-date VP1420 / VP1421 documentation, visit <http://www.aten.com/global/en/>
-

Conventions

This manual uses the following conventions:

- `Monospaced` Indicates text that you should key in.
- [] Indicates keys you should press. For example, [Enter] means to press the **Enter** key. If keys need to be chorded, they appear together in the same bracket with a plus sign between them: [Ctrl+Alt].
 - 1. Numbered lists represent procedures with sequential steps.
 - ◆ Bullet lists provide information, but do not involve sequential steps.
 - Indicates selecting the option (on a menu or dialog box, for example), that comes next. For example, Start → Run means to open the *Start* menu, and then select *Run*.
 -  Indicates critical information.

Product Information

For information about all ATEN products and how they can help you connect without limits, visit ATEN on the Web or contact an ATEN Authorized Reseller. Visit ATEN on the Web for a list of locations and telephone numbers:

International	http://www.aten.com
North America	http://www.aten-usa.com

Chapter 1

Introduction

Overview

The ATEN VP1420/VP1421 is a multi-in-one presentation switch that integrates a video matrix switch, True 4K scaler, analog-to-digital converter, audio processor (VP1420), HDBaseT Extender (VP1421), and audio DSP (VP1421) into one compact device. With the four analog/digital inputs to 2 HDMI True 4K outputs (VP1420) / 1 HDMI & 1 HDBaseT outputs (VP1421), the VP1420/VP1421 is designed to boost the efficiency and impact of professional presentations.

With its versatile control via the front panel, IR remote controller, control protocols (RS-232 and Telnet), and web GUI, the VP1420/VP1421 reduces not only system device count, but also lowers operation complexity. The VP1420/VP1421 is suitable for all meeting space and education environments, such as huddle rooms, classrooms, training rooms, or any other presentation setting, such as exhibition galleries or hotels.

Features

VP1420

Analog/Digital AV Matrix

- ◆ Supports 4 multi-format inputs – 3 HDMI and 1 VGA inputs
- ◆ 2 HDMI outputs
- ◆ Audio embedding – stereo audio can be embedded into HDMI output or separated to stereo line out
- ◆ Audio de-embedding – HDMI audio can be extracted to stereo line out
- ◆ Auto switching – automatically detects and switches to a new source as soon as it is connected

High-definition Video with Optimum Output

- ◆ Superior video quality – True 4K resolutions up to 4096 x 2160@60Hz (4:4:4)(HDMI)
- ◆ Supports 4K HDR
- ◆ Scaler – supports video upscaling to 4K for display A and downscaling to 1080p for display B
- ◆ EDID Export™ – automatically selects the optimum EDID settings for smooth power-up, high-quality display, and the best video resolution across connected devices
- ◆ HDMI 2.0 (3D, Deep Color, 4K); HDCP 2.2 compliant

Versatile, Streamlined Operation

- ◆ Multiple Control Options – flexible control via the front panel, IR remote control, control protocols (RS-232 and Telnet), and web-based GUI through Ethernet
- ◆ Supports standby mode for power saving and fast waking up
- ◆ Consumer Electronics Control (CEC) support
- ◆ Built-in contact in and LED out ports for keypad control using the ATEN VPK104 Contact Closure Remote Pad

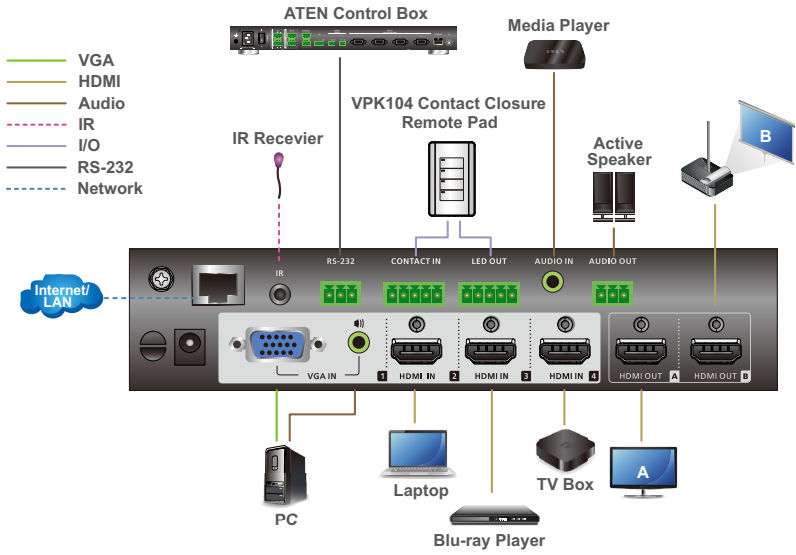

VP1421

Analog/Digital AV Matrix

- ◆ Supports 4 multi-format inputs – 2 HDMI, 1 HDBaseT, and 1 VGA inputs
- ◆ 1 HDMI and 1 HDBaseT outputs
- ◆ Audio embedding – stereo audio can be embedded into the display output or separated to stereo or optical audio outputs
- ◆ Audio de-embedding – HDMI/HDBaseT audio can be extracted to stereo audio output
- ◆ Built-in audio DSP – supports microphone input with selectable 48V Phantom Power and allows microphone input to be mixed with program audio and embedded into display output
- ◆ Automatically reduces program audio when a microphone signal is detected
- ◆ Auto switching – automatically detects and switches to a new source as soon as it is connected for time-saving and convenience

High-definition Video with Optimum Output

- ◆ Superior video quality – Up to 4096 x 2160@60Hz (4:4:4) (HDMI) / Up to 4096 x 2160@60Hz (4:2:0) (HDBaseT)
- ◆ Supports HDR
- ◆ Scaler – supports video upscaling to 4K for display A and downscaling to 1080p for display B
- ◆ EDID Export™ – automatically selects the optimum EDID settings for smooth power-up, high-quality display, and the best video resolution across connected devices
- ◆ HDMI 2.0 (3D, Deep Color, 4K); HDCP 2.2 compliant

Versatile, Streamlined Operation

- ◆ Multiple Control Options – flexible control via the front panel, IR remote control, control protocols (RS-232 and Telnet), and web-based GUI through Ethernet
- ◆ Bi-directional RS-232 and IR channel – allows AV device control over HDBaseT connection without additional cabling
- ◆ Supports standby mode for power saving and fast waking up
- ◆ Consumer Electronics Control (CEC) support

- ◆ Built-in contact in and LED out ports for keypad control using the ATEN VPK104 Contact Closure Remote Pad

Extended Transmission over One Cable

- ◆ Long-distance transmission – transmit digital AV signal, bi-directional RS-232, and IR control signals up to 140 m via Cat 6/6a or ATEN 2L-2910 Cat 6 cables

Note: This is achieved using the HDBaseT In and HDBaseT Out ports on the VP1421, each extending the transmission up to 70 m.

- ◆ Power over HDBaseT (PoH) – remote powering over existing communication cable with selectable powering device.

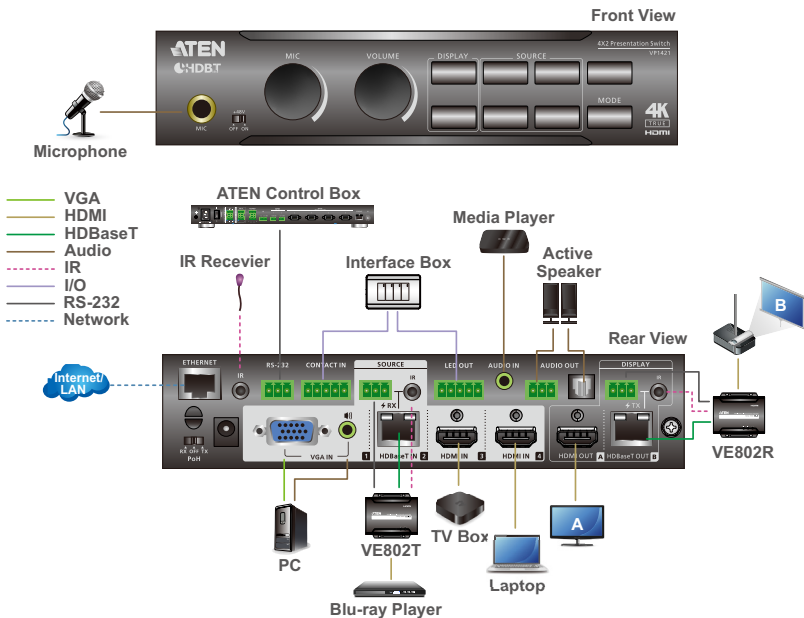

Planning the Installation

Required Equipment

Prepare the following equipment before installing the VP1420 / VP1421.

VP1420

- ◆ Up to 3 input devices equipped with HDMI and 1 input device equipped with a VGA port
- ◆ Up to 2 display devices each equipped with an HDMI port

VP1421

- ◆ Up to 2 input devices equipped with HDMI ports, 1 input device equipped with an HDBaseT port and 1 device equipped with a VGA port
- ◆ Up to 2 display devices, one equipped with an HDMI port and the other equipped with an HDBaseT port

Optional Equipment

Prepare the following equipment as required.

VP1420

- ◆ 1 media player
- ◆ 1 Active Speaker
- ◆ 1 Ethernet cable to connect the VP1421 to a network switch for remote management via the web console
- ◆ 1 host computer, ATEN Controller, or third-party control system that supports RS-232 or Telnet
- ◆ 1 ATEN VPK104 Contact Closure Remote Pad for convenient operation
- ◆ Mounting kits:
 - ◆ Rack Mount Kit
 - ◆ Under Desk Mount Kit

VP1421

- ◆ 1 microphone
- ◆ 1 media player
- ◆ 1 Active Speaker
- ◆ 1 video transmitter and 1 receiver equipped with HDBaseT ports for signal extension
- ◆ 1 Ethernet cable to connect the VP1421 to a network switch for remote management via the web console
- ◆ 1 host computer, ATEN Controller, or third-party control system that supports RS-232 or Telnet
- ◆ 1 ATEN VPK104 Contact Closure Remote Pad for convenient operation
- ◆ Mounting kits:
 - ◆ Rack Mount Kit
 - ◆ Under Desk Mount Kit

This Page Intentionally Left Blank

Chapter 2

Hardware Setup



1. Please review the safety information regarding the placement of this device in *Safety Instructions*, page 99.
2. Do not power on the VP1420 / VP1421 until all the necessary hardware is connected.

Hardware Overview

VP1420

Front View

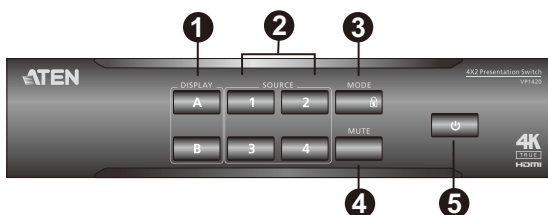

No.	Component	Description
1	Display Selection Pushbuttons	Press to focus a display. The pushbutton for the focused display lights orange.
2	Source Selection Pushbuttons	Press to select a source for the focused display. The pushbutton for the selected source lights green.
3	Mode Pushbutton	<ul style="list-style-type: none">◆ Press the pushbutton once to show the current mode setting.◆ Press the pushbutton twice to switch between the Matrix mode and the Mirror mode.
4	Mute Pushbutton	Press to mute all displays and speakers.
5	Power Pushbutton	Used to power on/off the VP1420, or enable/disable the standby mode. For details, see <i>Power LED Indication</i> , page 29.

Rear View

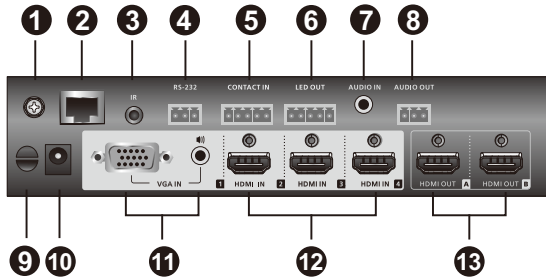

No.	Component	Description
1	Grounding Terminal	Grounds the VP1420 to prevent damages from power surge or static electricity.
2	Ethernet Port	Connects to a network switch via an Ethernet cable to allow remote operation via the web console.
3	IR Receiver Port	Connects to an IR receiver to receive IR signals from the IR remote control.
4	RS-232 Serial Port	Connects to a hardware or software controller to transmit serial data.
5	Contact In	Connects to the Contact Out terminal of a contact closure interface.
6	LED Out	Connects to the LED In terminal of a contact closure interface
7	Audio In	Receives an audio source.
8	Audio Out	Connects to an active speaker.
9	Cable Tie Slot	Reserved for a cable tie to hold the power adapter in place.
10	Power Jack	Receives a power adapter of the VP1420.
11	Source (1)	Connects to a VGA source and a stereo audio source.
12	Source (2), (3), (4)	Each connects to an HDMI source device via an HDMI cable.
13	HDMI Out	Each connects to an HDMI-enabled display device.

VP1421

Front View

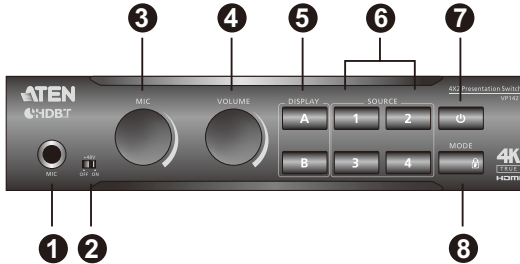

No.	Component	Description
1	MIC In Port	Connects to a microphone.
2	Phantom Power Switch	Enables or disables the supply of phantom power to a condenser microphone.
3	MIC Volume Control	Use the knob to adjust the microphone volume.
4	Overall Volume Control	Use the knob to adjust the volume of all audio outputs.
5	Display Selection Pushbuttons	Press a pushbutton to focus a display. The pushbutton for the focused display lights orange.
6	Source Selection Pushbuttons	Press a pushbutton to select a source for the focused display. The pushbutton for the selected source lights green.
7	Power Pushbutton	Used to power on/off the VP1420, or enable/disable the standby mode. For details, see <i>Power LED Indication</i> , page 29.
8	Mode Pushbutton	<ul style="list-style-type: none"> ◆ To show the current display mode, press the pushbutton once ◆ To switch between the Matrix mode and the Mirror mode, press the pushbutton twice.

Rear View

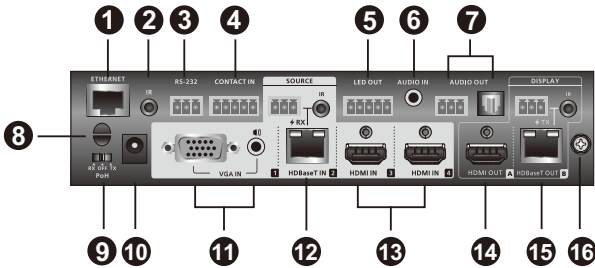

No.	Component	Description
1	Ethernet Port	Connects to a network switch via an Ethernet cable to allow remote operation via the web console.
2	IR Receiver Port	Connects to an IR receiver to receive IR signals from the IR remote control.
3	RS-232 Serial Port	Connects to a hardware or software controller to transmit serial data.
4	Contact In	Connects to the Contact Out terminal of a contact closure interface.
5	LED Out	Connects to the LED In terminal of a contact closure interface
6	Audio In Port	Receives an audio source.
7	Audio Out Ports	Connects to an active speaker.
8	Cable Tie Slot	Reserved for a cable tie to hold the power adapter in place.
9	PoH Control Switch	Enables the transmission of power along with data signals to either the Tx or Rx connected to the VP1421 over an Ethernet cable.
10	Power Jack	Receives a power adapter of the VP1421.
11	Source (1)	Connects to a VGA source and a stereo audio source.
12	Source (2)	Connects to a source device at a distance via a Tx device equipped with an HDBaseT port
13	Source (3), (4)	Connect to HDMI source devices via HDMI cables.
14	Output/Display A	Connects to an HDMI-enabled display device.

No.	Component	Description
15	Output/Display B	Connects to an Rx device which in turn connected to a display device at a distance.
16	Grounding Terminal	Grounds the VP1421 to prevent damages from power surge or static electricity.

IR Remote Control

To operate the VP1420 / VP1421, insert the supplied IR Receiver to the IR Receiver Port on back panel of the device.

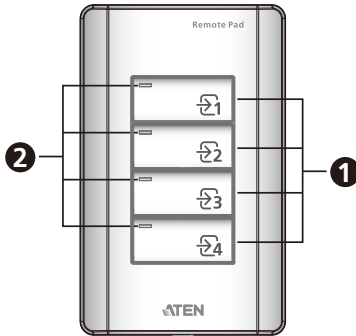

No.	Buttons	Description
1	On/Off	Used to power on the VP1420 / VP1421 and enable/disable the standby mode. For details, see <i>Power LED Indication</i> , page 29.
2	Source	Press a Source button to switch the focused display to the source.
3	Display	Press a Display button to focus the display.
4	Mute	Press the button to mute all displays and speakers.
5	Mode	<ul style="list-style-type: none"> ◆ Press the pushbutton once to show the current mode setting. ◆ Press the pushbutton twice to switch between the Matrix mode and the Mirror mode.

VPK104**Front View**

No.	Component	Description
1	Source Selection Buttons	Press a source selection button to put the source onto the set display*. The number on each button represents the source number at the rear of the VP1420 / VP1421. Note: * The set display is selected using the VP1420 / VP1421 web GUI.
2	Status LEDs	Lights green to indicate that the source is selected.

Rear View

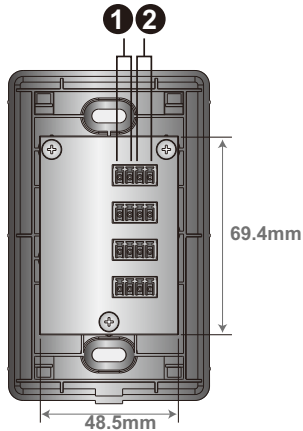

No.	Component	Description
1	LED In Port	Connects to the LED Out port on the VP1420 / VP1421 to transmit and receive LED signals.
2	Contact Out Port	Connects to the Contact In port on the VP1420 / VP1421 to transmit and receive operation signals.

Side View

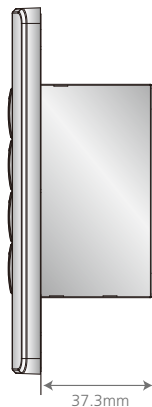

Mounting

Rack Mount

The VP1420 / VP1421 can be mounted on a 19" (1U) system rack. To conveniently access the front panel for local configuration and operation, mount the unit in a rack with the front panel facing outward.

Note: The Rack Mount Kit is not included in the package. Visit the product web page for more information.

1. Use the M3 Phillips hex head screws supplied with the mounting kit to secure the rack mounting brackets onto the unit.

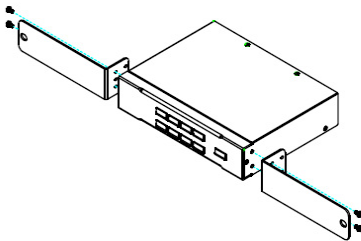

VP1420

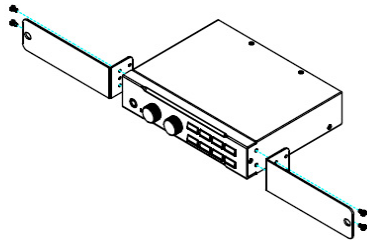

VP1421

2. Position the unit in the front of the rack and align the holes in the mounting brackets with the holes in the rack.
3. Secure the mounting brackets to the rack using self-prepared screws.

Under Desk Mount

The VP1420 / VP1421 can be installed under a desk. To conveniently access the front panel for local configuration and operation, install the unit with the front panel facing forward.

Note: The mounting kit required for this installation is not included in the package. Visit the product web page for more information.

1. Use the M3 Phillips hex head screws supplied with the mounting kit to secure the mounting brackets onto the unit.

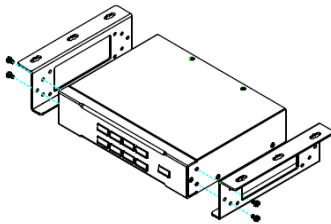

VP1420

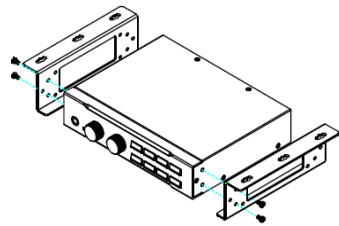

VP1421

2. Position the unit to a spot under the desk where you can easily access the front panel, and then secure the racks to the desk with self-prepared screws.

Installation

VP1420

Follow the steps below to safely install sources, displays, and other equipment to the VP1420.

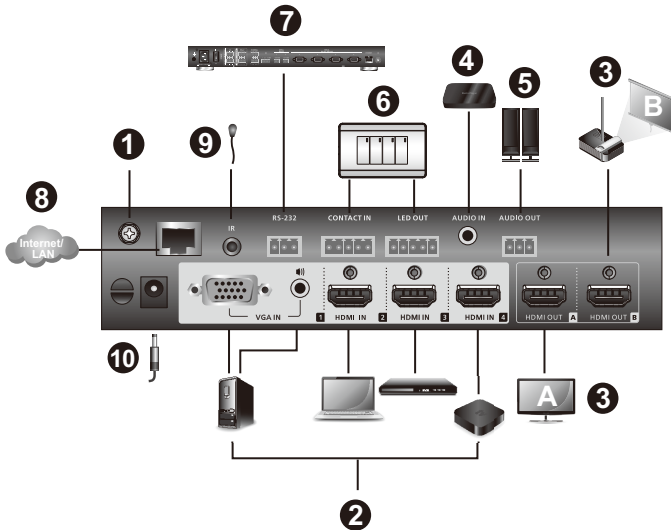

1. Use a grounding wire to ground the unit by connecting one end to the grounding terminal, and the other end to a suitable grounded object.

Note: Do not omit this step. Proper grounding helps prevent damage to the unit from surges or static electricity.

2. Connect the unit to video sources.
 - ◆ To connect to a VGA source, use a VGA cable and a stereo audio cable to connect the source to the VGA In and the Stereo Audio In port respectively.
 - ◆ To connect to an HDMI-enabled source, use an HDMI cable to connect the device to the HDMI In port. You can connect up to three HDMI-enabled sources.
3. Use an HDMI cable to connect the unit to at least one HDMI-enabled display.

4. (Optional) Connect the unit to an audio source device, such as a media player, to the Audio In port.
5. (Optional) Connect an active speaker to the Audio Out port using the provided 3-pole Terminal Block.
6. (Optional) To control the unit via a contact closure switch, connect the switch to the Contact In and LED Out ports using the provided 5-pole Terminal Blocks.
7. (Optional) To configure the system settings via RS-232 serial commands, connect a hardware controller, such as ATEN Control Box, to the RS-232 Serial Port using the provided 3-pole Terminal Blocks.
8. (Optional) To allow access to the web interface, use an Ethernet cable to connect the unit's Ethernet port to a network switch.
9. (Optional) To control the VP1420 using an IR remote control, connect the supplied IR receiver to the IR Receiver port.
10. Plug the power adapter to the Power Jack. Optionally use the cable tie slot and a cable tie to hold the power cable in place.
11. Press the Power Pushbutton to power on the unit.
12. Power on all the connected devices.

VP1421

Follow the steps below to safely install sources, displays, and other equipment to the VP1421.

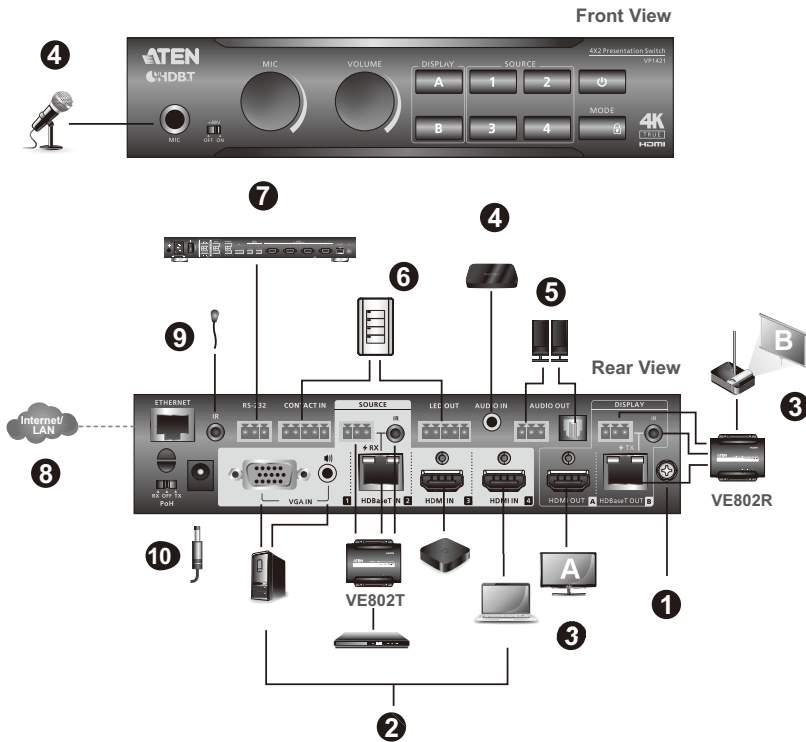

1. Use a grounding wire to ground the unit by connecting one end to the grounding terminal, and the other end to a suitable grounded object.

Note: Do not omit this step. Proper grounding helps prevent damage to the unit from surges or static electricity.

2. Connect the unit to video sources.
 - ◆ To connect to a VGA source, use a VGA cable and a stereo audio cable to connect the source to Source (1) ports.
 - ◆ To connect to a video source that requires signal extension, connect the VP1421's HDBaseT In port to the HDBaseT Out port of a Tx device using an Ethernet cable.

Note: Visit the VP1421 web page for a list of supported video extenders.

- ◆ To connect to an HDMI source, connect the device to the VP1421's HDMI In port using an HDMI cable. You can connect up to two HDMI sources.

Note: The VP1421 supports bidirectional RS-232 and IR pass-through.

3. Connect the unit to displays.

- ◆ Use an HDMI cable to connect the unit to an HDMI display.
- ◆ To set up a display at a distance, use an Ethernet cable to connect the VP1421's HDBaseT Out port to the HDBaseT In port of a suitable Rx device, to which the display is connected.

Note: To supply power to the connected video transmitter through the Rx terminal of the VP1421, set the PoH Control Switch to **Rx** and vice versa.

4. (Optional) To supply independent audio, connect an audio source device (e.g. media player) or a microphone to the Audio In port. If you use a condenser microphone, put the Phantom Power Switch to **ON**.
5. (Optional) Connect an active speaker to the Audio Out port.
6. (Optional) To control the VP1421 via a contact closure switch, connect the switch to the Contact In and LED Out ports using the provided 5-pole Terminal Blocks.
7. (Optional) To configure the unit's settings via RS-232 commands, connect a hardware controller, e.g. ATEN Control Box, to the RS-232 Serial Port using the provided 3-pole Terminal Block.
8. (Optional) To allow access to the web interface, use an Ethernet cable to connect the Ethernet port of the unit to a network switch.
9. (Optional) To control the VP1421 using an IR remote control, connect the IR receiver to the IR Receiver port.
10. Plug the power adapter to the Power Jack. Optionally use the cable tie slot and a cable tie to holder the power cable in place.
11. Press the Power Pushbutton to power on the unit.
12. Power on all the connected devices.

VPK104

Follow the steps below to safely install the Remote Pad to the VP1420 / VP1421. Before you start, prepare 2 screws, 1 wall box, and some core wires.

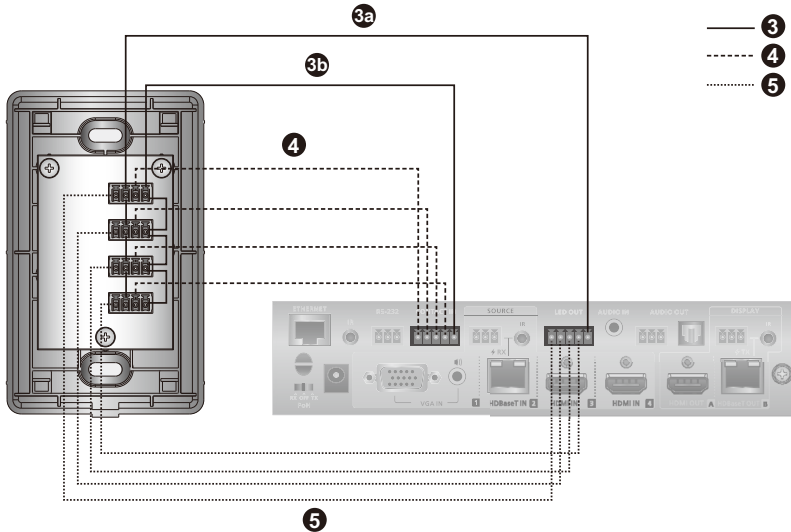

1. (Optional) Prepare your installation site and install a Wall Box.
2. Remove the faceplate from the Remote Pad.
3. Ground the Remote Pad.
 - a) Use core wires to serially connect the Remote Pad's LED In (-) poles to the GND pole of the LED Out terminal on the Presentation Switch.
 - b) Use core wires to serially connect the Remote Pad's Contact Out (-) poles to the GND pole of the Contact In terminal on the Presentation Switch.
4. Use a core wire to connect the Remote Pad's LED In Port 1 (+) to the LED Out pole 1 on the Presentation Switch. Repeat this step for other LED In Ports.
5. Use a core wire to connect the Remote Pad's Contact Out Port 1 (+) to the Contact In pole 1 on the Presentation Switch. Repeat this step for other Contact Out Ports.
6. Make sure the keys are installed to the VPK104 and then secure the unit to the wall box using two screws.

7. Cover the unit with the faceplate.

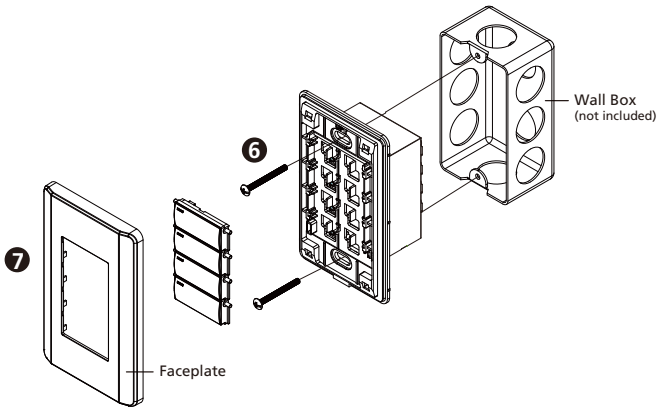

Chapter 3

Local Operation

Overview

This chapter provides information on operating the VP1420 / VP1421 using the front panel and IR remote control.

Note: The instructions use *pushbutton* to refer to the front panel and *button* to refer to the IR remote control.

Operation Considerations

- ◆ To use the IR remote control, make sure to insert the IR receiver (supplied in the package) to the VP1420 / VP1421.
- ◆ To ensure smooth operation using the IR remote control, use the IR remote control within the effective range (6 m) and keep a clear line-of-sight between the remote control and the IR receiver connected to the VP1420 / VP1421.

Switching Sources

To switch the video source on a display:



1. Press a **Display Selection** pushbutton/button to select a display. The pushbutton for the selected display lights orange.
2. Press a **Source Selection** pushbutton/button to assign the source. The pushbutton for the selected source lights orange.

Note:  appears on the top left corner of the OSD for 5 seconds when the source is switched. This is the resolution from the original source without scaling.

Display Mode

Understanding Display Mode

The VP1420 / VP1421 supports the following display modes:

- ◆ **Matrix mode** (): When enabled, the AV sources can be configured separately, capable of showing different outputs.
- ◆ **Mirror mode** (): When enabled, display B uses the AV source assigned for display A and shows identical content.

Configuration

To show the current display mode, press the **Mode** pushbutton/button once. The current setting displays at the bottom left corner of display A. To change the display mode, press the **Mode** pushbutton again.



Audio Settings

- ◆ To adjust the volume for all audio outputs on the VP1421, use the **Volume** knob on the front panel or the **Volume Up** or **Volume Down** buttons on the IR remote control.
- ◆ To adjust the volume of a microphone or an independent audio source on the VP1421, use the **MIC** knob on the front panel.
- ◆ To mute all audio outputs (displays and speaker):
 - ◆ For VP1420, press the **Mute** pushbutton/button.
 - ◆ For VP1421, press the **Volume** knob on the front panel or press the **Mute** button on the IR remote control.

Panel Lock

To prevent accidental tampering of system settings via the front panel, you can lock the panel using the **Mode** pushbutton or set up an idle time for an auto lock via the web console (**General > Panel Auto Lock**). Refer to the table below for how to enable/disable the panel lock and the corresponding LED indication.

Task	Lock LED  (Mode Pushbutton)
To lock the front panel, press and hold the Mode pushbutton for about 3 seconds.	Lights red
To unlock the front panel, press and hold the Mode pushbutton for about 3 seconds.	Dims
If any front panel pushbutton/knob is adjusted when the panel is locked.	Flashes 3 times

Note: If you have locked the panel using the **Mode** pushbutton, make sure to unlock only by pressing the **Mode** pushbutton. Disabling panel lock from the web console will not be effective in this case.

Power LED Indication

The power pushbutton is equipped with an LED that indicates the power status of the VP1420 / VP1421. Refer to the table below for the status and supported tasks for each LED indication.

LED Indication (Power Pushbutton)	VP1420 / VP1421 Status	Tasks
Dim	The VP1420 / VP1421 is powered off.	To power on the VP1420 / VP1421, press the Power pushbutton/button once.
Flashes orange	The VP1420 / VP1421 is loading system information.	Wait for the unit to finish loading information.
Orange	The VP1420 / VP1421 is in standby mode.	<p>The standby mode is a power-saving mode that shuts parts of the system down to allow the user to quickly resume operation when needed.</p> <p>To awake the VP1420 / VP1421, press the Power pushbutton/button once.</p> <p>Note: To power off the VP1420 / VP1421 when it is in standby mode, awake the unit first, and then follow the steps in the next entry to power off the unit.</p>
Green	The VP1420 / VP1421 is awoken.	<ul style="list-style-type: none"> ◆ To enable the standby mode to conserve power, press the Power pushbutton/button once. ◆ To power off the unit: <ol style="list-style-type: none"> (1) Press and hold the Power pushbutton for 3 seconds. A confirmation message appears in the OSD. (2) Press the Power pushbutton once. The VP1420 / VP1421 powers off. <p>Note: The remote control can not be used to power off the VP1420 / VP1421.</p>

This page is intentionally left blank.

Chapter 4

Remote Operation

Overview

This chapter provides information on how to remotely operate and configure the VP1420 / VP1421 via the web console.

Default Network and Login Settings

The VP1420 / VP1421 uses the following network settings and login credentials as its default settings.

- ◆ Default network settings

Network Parameter	Default Setting
IP Address	192.168.0.60
Subnet Mask	255.255.255.0
Gateway	192.168.0.1
HTTP Port	80

Note: If the VP1420 / VP1421 is connected to a router that supports DHCP, a dynamic IP address will be assigned to the VP1420 / VP1421 as soon as it connects to the network. Look up the IP address by sending a `read` command via an RS-232 serial controller. For more details, see *Chapter 5, CLI Commands*.

- ◆ Default login credentials

Login Credential	Default Setting	Limitations
Username	administrator	5 to 30 characters in length without special characters, not case-sensitive
Password	password	

Supported Web Browsers

The VP1420 / VP1421 supports access to its web UI through the following web browsers and operating systems:

Operating System	Web Browser	Supported Version
Windows 10 x 64	Edge	40.15063.674.0
Windows 10 x 64	Firefox	64.0
Windows 10 x 64	Chrome	71.0.3578.98
Windows 10 x 64	Opera	57.0.3098.91
Windows 8.1	IE	11
Windows 7 SP1 x 64	IE	11
CentOS 7.5 x 64 Kernel 4.18.11-1	Firefox	60.0.4
Ubuntu 18.04 x 64 Kernel 4.19.041900rc3	Chrome	71.0.3578.98-1
Solaris 11.4 x 64 5.11	Firefox	52.9.0
Windows 10 x 64	QQ	10.2.1
Windows 10 x 64	Baidu	8.7.5000.4980
Windows 10 x 64	360	9.1.0434
MAC 10.14.4	Safari	8

Logging In the Web Console

1. In a web browser, type the IP address of the VP1420 / VP1421. This screen appears.





2. Type the username **administrator** and the password.
3. Click **Log In**. The main screen appears.

The Main Screen

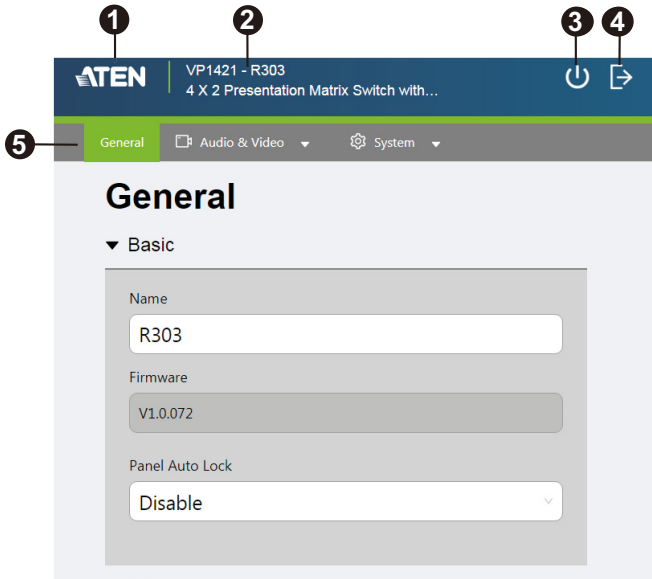
The VP1420 / VP1421 defaults to the main screen after logging in. Refer to the illustration and table below for an overview of the web console.



No.	Element	Description
1		Click the ATEN logo to visit ATEN's official website.
2	Device Information	Indicates the device model and name.
3		Click this icon enable the standby mode, a power-saving mode that shuts parts of the system down to allow the user to quickly resume operation when needed.
4		Click the icon to log out of the web console.
5	Settings Tab	Click on the tabs to switch between different sets of settings.

General Settings

The General page includes settings such as device name, panel lock, EDID, and login password. To access the general settings, log in the web console and the screen defaults to the page.

General

▼ Basic

Name

Firmware

Panel Auto Lock

Control by APP

① Download APP
"ATEN Video Presentation Control"

iOS

Android

② ROOM Control Entry

Room:30999999

▼ Advance

EDID

Target of Contact Closure (DI)

HDCP Mode

▼ Change Password

Administrator
Username
administrator
Password
.....
Confirm Password
.....

Basic User
Username

Password

Confirm Password

◆ **Basic**

- ◆ **Name:** Type a name for the VP1420 / VP1421. A valid name should be within 30 characters in length and contains no special characters. This name appears on the web console immediately after the model name:

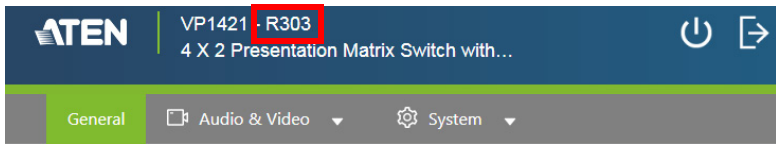

- ◆ **Firmware:** Indicates the firmware version for the VP1420 / VP1421.
- ◆ **Panel Auto Lock:** Sets the idle time for the front panel to be locked.
- ◆ **Control by App:**
 - ◆ To download the ATEN Video Presentation Control app to your mobile device, use your mobile device and scan the QR code under **(1) Download App**.
 - ◆ To log in the ATEN Video Presentation Control app as a basic user (has access to audio and video sources only), scan the QR code under **(2) Room Control Entry**.

- ◆ **Note:** Make sure to set up the basic user account for the QR code to display.**Advance**
 - ◆ **EDID**
 - ◆ **Display A:** This mode sends the EDID of Display A to the connected sources.
 - ◆ **ATEN Default:** This mode sends ATEN-predefined EDID to the connected sources.
 - ◆ **Remix:** Sends the optimum EDID of the connected displays to the connected sources.
 - ◆ **Target of Contact Closure:** Defines the display that a connected contact closure controls.
 - ◆ **HDCP Mode:** Sets the HDCP of the VP1420 / VP1421.
- ◆ **Change Password**
 - ◆ **Administrator:**The administrator account has access to all settings in the web console. The default password is **administrator**.
 - ◆ **Basic User:** A basic user account has access to the audio and video controls on the web console or ATEN Video Presentation Control App. To create a basic user account, specify the username and password fields here.

Note: A valid password (for the administrator or basic user account) is not case-sensitive and should be 5 to 6 characters in length, without space or special characters.

Audio & Video Settings

Audio Control

To access the audio control page, log in the web console, and then go to **Video & Audio > Audio**.

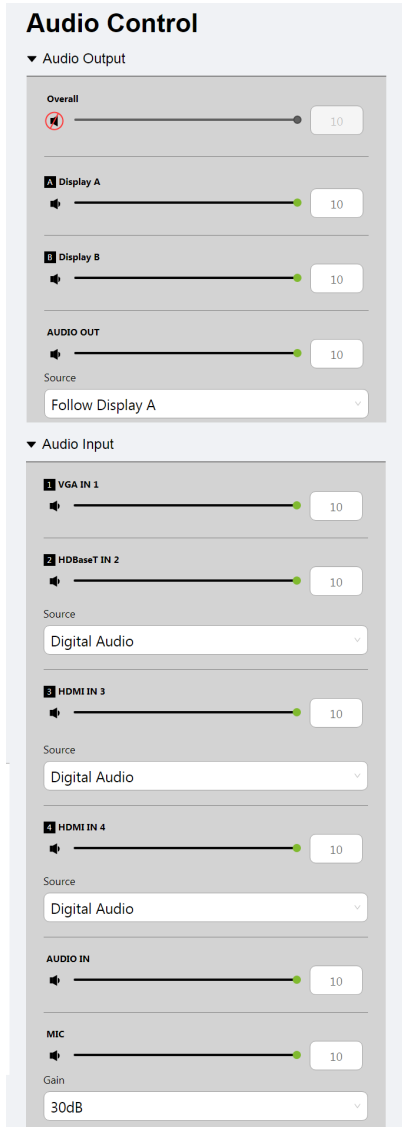

Audio Output

- ◆ **Overall volume:**
 - ◆ VP1420: Mute or unmute the connected speaker.
 - ◆ VP1421: Sets the volume of the connected speaker.
- ◆ **Display A**
 - ◆ VP1420: Mute or unmute display A.
 - ◆ VP1421: Sets the volume of display A.
- ◆ **Display B**
 - ◆ VP1420: Mute or unmute display B.
 - ◆ VP1421: Sets the volume of display B.
- ◆ **Audio Out**
 - ◆ VP1420: Mute or unmute the independent speaker connected to the Audio Out port.
 - ◆ VP1421: Sets the volume of the independent speaker connected to the Audio Out port.
 - ◆ **Source:** Sets the audio source for the independent speaker connected to the Audio Out port of the VP1420 / VP1421.
 - ◆ To use the same audio source for display A, select **Follow Display A**.
 - ◆ To use the same audio source for display B, select **Follow Display B**.
 - ◆ To use the independent audio source (connected to the Audio In port), select **Audio In**.

Audio Input (VP1420)

- ◆ **HDMI In 2 / HDMI In 3 / HDMI In 4:** N/A.
 - ◆ **Source:** Sets the audio source for the HDMI 2 / HDMI 3 / HDMI 4 source. To use the audio source that comes along with the video, select **Digital Audio**. To use the audio source from the independent audio source (connected to the Audio In port), select **Embedded Audio In**.

Audio Input (VP1421)

- ◆ **VGA In 1:** Sets the volume of the VGA source.
- ◆ **HDBaseT In 2:** Sets the volume of the HDBaseT source.
 - ◆ **Source:** Sets the audio source for the HDBaseT source. To use the audio source that comes along with the video, select **Digital Audio**. To use the audio source from the independent audio source (connected to the Audio In port), select **Embedded Audio In**.
- ◆ **HDMI In 3 / HDMI In 4:** Sets the volume of the HDMI 3 / HDMI 4 source.
 - ◆ **Source:** Sets the audio source for the HDMI 3 / HDMI 4 source. To use the audio source that comes along with the video, select **Digital Audio**. To use the audio source from the independent audio source (connected to the Audio In port), select **Embedded Audio In**.
- ◆ **Audio In:** Sets the volume of the independent audio source connected to the Audio In port.
- ◆ **Mic volume:** Sets the volume of the microphone connected to the MIC port.
 - ◆ **Gain:** Sets the volume of the microphone connected to the MIC port.

Apply vs. Auto Apply

To automatically apply the changes you make on the Audio Control page, select **Auto apply** at the bottom of the page.

Video Control

Use the video control page to assign video sources and configure video settings. To access the video control page, log in the web console, and then go to **Video & Audio > Video**.

The screenshot shows the Video Control interface with the following details:

- Navigation:** General, Audio & Video, System.
- Section:** Video Control.
- Display A:**
 - Preview: Blue background with a white circle containing the number 4.
 - Source List:
 - VGA IN 1: No signal
 - HDBaseT IN 2: No signal
 - HDMI IN 3: Connection
 - HDMI IN 4: Connection (Selected)
 - CEC: Enable
 - Scaler Up: Auto
 - Auto Switching(Plugged): Disable
 - Auto Switching(UnPlugged): Disable
- Display B:**
 - Preview: Green background with a white circle containing the number 3.
 - Mirror Mode:
 - Source List:
 - VGA IN 1: No signal
 - HDBaseT IN 2: No signal
 - HDMI IN 3: Connection (Selected)
 - HDMI IN 4: Connection
 - CEC: Enable
 - Scaler Down: Auto
- Footer:** Apply button, Auto apply checkbox.

- ◆ **Display A / Display B:** Shows a preview of the currently selected source and indicates the source number at the center of the preview. Click  to rename the source.
- ◆ **Mirror Mode:** Select this option for display B to show identical video content as display A.
- ◆ **Source:** Lists the connection status of all source ports and the currently assigned source (indicated in green).

- ◆ To switch the source for the display, click on one of the listed sources. The assigned source is highlighted green.
- ◆ To rename the source, click .
- ◆ **CEC:** Consumer Electronics Control (CEC) allows for control of devices connected through HDMI ports to communicate with each other and makes the control of these devices using one remote control device possible. This setting is enabled by default.
- ◆ **Scaler Up:** To automatically scale the resolution of a 1080p source up to 4K, select **Auto**. For a list of supported upscaling resolutions, see *Specifications*, **page 103**.
- ◆ **Scaler Down:** To automatically scale the resolution of a 4K source down to 1080p, select **Auto**. For a list of supported downscaling resolutions, see *Specifications*, **page 103**.
- ◆ **Auto Switching (Plugged):** Defines the automatic switching of audio-video source on Display A when a new source is plugged in.
 - ◆ **Disable:** Disable automatic switching.
 - ◆ **Next:** Automatically switches to the newly plugged-in source.
- ◆ **Auto Switching (Unplugged):** Defines the automatic switching of video source on Display A when a previously used source goes detected.
 - ◆ **Disable:** Disable automatic switching.
 - ◆ **Next:** Automatically switches to the next available source when the current video source is plugged out.
 - ◆ **Last:** Automatically switch the display to the previous available source based on the order of source connection. For example, if sources are connected to the VP1420 / VP1421 in the order of port 2, port 3, port 4 and then port 1, and that Display A is switched to port 3, when the source (port 3) is unplugged, Display A will automatically switch to port 2.

Apply vs. Auto Apply

To automatically apply the changes you make on the Video Control page, select **Auto apply** at the bottom of the page.

System Settings

Maintenance

Use the maintenance page to upgrade system firmware, back up or restore system configurations, and restore default settings. To access the maintenance page, log in the web console, and then go to **System > Maintenance**.

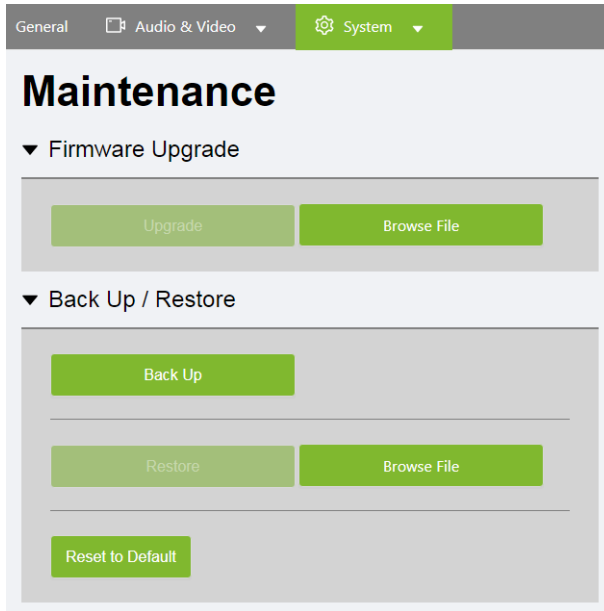

Upgrading the System Firmware

1. Prepare the firmware file you wish to apply.
 - a) Visit the product web page from <http://www.aten.com/global/en/>
 - b) In the **Support and Download** tab, download a firmware file.
2. Log in the VP1420 / VP1421's web console, and then go to **System > Maintenance**.
3. In the Firmware Upgrade section, click **Browse File** to select the firmware file that you downloaded, and then click **Upgrade**. The upgrade starts immediately.
4. When the upgrade is complete, a confirmation message appears and the unit reboots.

Backing Up System Settings

You can back up and export the VP1420 / VP1421's configurations. This backup will not include the username and password settings.

1. Log in the VP1420 / VP1421's web console, and then go to **System > Maintenance**.
2. Click **Back Up**.

Restoring System Settings

1. Log in the VP1420 / VP1421's web console, and then go to **System > Maintenance**.
2. To restore the VP1420 / VP1421's settings, click **Browse File** to locate a previously backed up file (.aes), and then click **Restore**.

Resetting the Default Settings

1. Log in the VP1420 / VP1421's web console, and then go to **System > Maintenance**.
2. Click **Reset to Default**. This will reset all the settings, including network settings to default.

Network Settings

To configure the VP1420 / VP1421's network connection settings, log in the web console, and then go to **System > Network**.

The screenshot shows the 'Network' configuration page. At the top, there are tabs for 'General', 'Audio & Video', and 'System'. The 'System' tab is active. Below the tabs, the page title is 'Network'. Underneath, there is a section for 'IP Settings' with a dropdown arrow. The 'Mode' is set to 'DHCP' (selected with a radio button) and 'Manual' is unselected. Below the mode are three input fields: 'IP address' with the value '10.3.166.250', 'Mask' with '255.255.254.0', and 'Gateway' with '10.3.167.254'. Below the IP settings is a section for 'Browser' with a dropdown arrow. Under 'Browser', there is a 'Timeout' field with a value of '30mins' and a dropdown arrow.

IP Settings

- ◆ **Mode:** Configure the method to which the VP1420 / VP1421 obtains an IP address and connects to the network.
 - ◆ **DHCP:** Select this option for the connected network switch to dynamically assign an IP address, subnet mask, gateway, and DNS to the VP1420 / VP1421.
 - ◆ **Manual:** Select this option for the VP1420 / VP1421 to use a fixed IP address. Specify the IP address, subnet mask, and default gateway.

Browser

- ◆ **Timeout:** Sets the duration of time that a web browser waits to obtain connection to the VP1420 / VP1421 before terminating the request.

This Page Intentionally Left Blank

Chapter 5

CLI Commands

Overview

The VP1420 / VP1421 can be configured and controlled via RS-232 or Telnet commands when connected to a host computer or other device, such as a control system. This chapter provides information on how to connect to the VP1420 / VP1421 via RS-232/Telnet and command syntax.

Connecting to the VP1420 / VP1421 via Telnet

To establish a Telnet session with the VP1420 / VP1421, do the following:

1. Connect a host computer or control system to a shared network with the VP1420 / VP1421.
2. Open a command-line interpreter program from your computer.
3. In the command-line interpreter, type the VP1420 / VP1421's IP address in the following way:

```
telnet [IP address]:23
```

4. Press **Enter**. The login screen appears.
5. At the login prompt, type the login username and password for the VP1420 / VP1421.
6. When a session is established with the VP1420 / VP1421, you can control and configure the VP1420 / VP1421 via RS-232 commands. For more information on commands, see:
 - ♦ *Command Syntax*, page 49
 - ♦ *Command List*, page 50

Note: If a user logs in using a username that is already in session, the newest login takes effect and the previous session will be replaced.

Connecting to the VP1420 / VP1421 via RS-232

1. Connect a host computer or control system to the RS-232 Serial port on the VP1420 / VP1421 unit.
2. Download and install controller software that supports RS-232 serial control and the operation system of your controller PC.
3. Execute the software and configure the connection settings to the following:
 - ◆ Serial line to connect to: **COM1**
 - ◆ Speed (baud): **19200**
 - ◆ Data bits: **8**
 - ◆ Stop bits: **1**
 - ◆ Parity: **None**
 - ◆ Flow control: **None**
4. When a session is established with the VP1420 / VP1421, you can control and configure the VP1420 / VP1421 via RS-232 commands. For more information on commands, see:
 - ◆ *Command Syntax*, page 49
 - ◆ *Command List*, page 50

Command Syntax

- ♦ The general form of a command is:

command parameter<argument> {one|two|three}

Notation	Description
command	The name of the command is shown in bold.
parameter	Indicates the name of the parameter.
<argument>	Indicates the name of the value or the information that the user must provide. Only type the information in the angle brackets, not the brackets themselves.
[]	Indicates optional items. Only type the information in the brackets, not the brackets themselves.
{ }	Indicates a set of choices from which the user must choose one.
	Indicates two or more mutually exclusive choices in a command line. Only type one of the choices in the command line, not the symbol.

- ♦ If you have two or more parameters, the order of these parameters among themselves does not affect the result of the operation. For example, both of the following commands execute the same task:

command name + parameter 1 + parameter 2

command name + parameter 2 + parameter 1

Command List

Use the following commands to control and configure the VP1420 / VP1421 via Telnet or RS-232. For details on establishing a Telnet or RS-232 session to the VP1420 / VP1421, see *Connecting to the VP1420 / VP1421 via Telnet*, page 47 and *Connecting to the VP1420 / VP1421 via RS-232*, page 48.

Port Numbers

Use the table below to find out the argument value for each input/output port on the VP1420 / VP1421. For example, the <input_port> value for video port 1 is i01, and the <input_port> value for audio input is i05.

Source	Source No.	Interface		Port Numbers
		VP1420	VP1421	
Video Input	1	VGA	VGA	i01
	2	HDMI	HDBaseT	i02
	3	HDMI	HDMI	i03
	4	HDMI	HDMI	i04
Video Output	1	HDMI	HDMI	o01
	2	HDMI	HDBaseT	o02
Audio Input	N/A	Stereo	Stereo	i05
Audio Output	N/A	-	Stereo	o03
	N/A	Optical	Optical	o03
MIC	N/A	-	✓	i06

cec

◆ Function

Enables/disables Consumer Electronics Control (CEC) on the specified port.

◆ Syntax

```
cec o<output_port>{on|off}
```

◆ Parameters

- ◆ o<output_port>: Specifies an output port in two digits.
- ◆ on: Enables CEC on the specified port.

- ◆ `off`: Disables CEC on the specified port.

- ◆ **Example**

```
cec 001 on
```

displaymode

- ◆ **Function**

Sets the VP1420 / VP1421 to matrix or mirror mode.

- ◆ **Syntax**

```
displaymode {matrix|mirror}
```

- ◆ **Parameters**

- ◆ `matrix`: When enabled, the AV sources can be configured separately, capable of showing different outputs.
- ◆ `mirror`: When enabled, display B uses the AV source assigned for display A and shows identical content.

- ◆ **Example**

```
displaymode matrix
```

echo

- ◆ **Function**

Updates an RS-232 controller connected to the VP1420 / VP1421 when operations are made to the VP1420 / VP1421 via its front panel, web console, or telnet. Execute this function to keep the RS-232 controller in sync with the VP1420 / VP1421.

- ◆ **Syntax**

```
echo {on|off}
```

- ◆ **Parameters**

- ◆ `on`: Enables echo on the specified port.
- ◆ `off`: Disables echo on the specified port.

edid

◆ **Function**

Sets the VP1420 / VP1421's EDID mode.

◆ **Syntax**

```
edid {port1|remix|default}
```

◆ **Parameters**

- ◆ `port1`: Set the VP1420 / VP1421's EDID mode to follow the display connected to the output port A.
- ◆ `remix`: Set the VP1420 / VP1421's EDID mode to remix with which the system sends the optimum EDID of the connected displays to the sources.
- ◆ `default`: Set the VP1420 / VP1421's EDID mode to ATEN Default which sends ATEN-predefined EDID to the connected sources.

◆ **Example**

```
edid default
```

mute

◆ **Functions and Syntax**

Syntax	Function
<code>mute</code>	Indicates the mute setting for each input and output port.
<code>mute {i<input_port> i*}</code>	Indicates the mute setting for the specified input or output port.
<code>mute {o<output_port> o sys o*}</code>	
<code>mute {i<input_port> i*} {on off}</code>	Mutes / unmutes the audio of a specified audio input (VP1421 only) or output.
<code>mute {o<output_port> o sys o*} {on off}</code>	

◆ **Parameters**

- ◆ `i<input_port>`: Specifies an input port in two digits.
- ◆ `i*`: Refers to all input ports.
- ◆ `o<output_port>`: Specifies an output port in two digits.
- ◆ `o sys`: Refers to all audio outputs (display devices and speakers).

- ◆ `o*`: Indicates all output ports.
- ◆ `on`: Mute the specified input/output ports.
- ◆ `off`: Unmute the specified input/output ports.

◆ **Example**

```
mute o01 off
```

read

◆ **Functions and Syntax**

Syntax	Function
<code>read</code>	Displays the video and audio input assigned to each output port, EDID mode, device information, and network settings.
<code>read version</code>	Displays the system firmware version.
<code>read o<output_port> connection</code>	Displays the video and audio input assignment to the specified output port.
<code>read o* connection video</code>	Displays the video input assignment to all output ports.
<code>read o<output_port> connection audio</code>	Displays the audio assignment to the specified output port.
<code>read o* connection audio</code>	Displays the audio input assignment to all output ports.

reset

◆ **Function**

Resets the VP1420 / VP1421 to its default settings.

◆ **Syntax**

```
reset
```

scaling

◆ **Functions and Syntax**

Syntax	Function
<code>scaling</code>	Reads the scaler settings on output A and B.
<code>scaling o<output_port> {auto off}</code>	Configures the specified output port to Auto or Off.

standby

Syntax	Function
<code>standby</code>	Displays the current standby mode setting. Standby mode is a power-saving mode that shuts parts of the system down to allow the user to quickly resume operation when needed.
<code>standby on off</code>	Enables or disables the standby mode.

◆ **Parameters**

- ◆ `on`: Enable standby mode.
- ◆ `off`: Disable standby mode.

SW◆ **Function**

Switches the specified source on the specified display.

◆ **Syntax**

```
sw {o<output_port>|o*} {i<input_port>|i+|i-}
```

◆ **Parameters**

- ◆ `i<input_port>`: Specifies an input port in two digits.
- ◆ `+`: Indicates the next input port.
- ◆ `-`: Indicates the previous input port.
- ◆ `o<output_port>`: Specifies an output port in two digits.
- ◆ `o*`: Indicates all output ports.

◆ **Examples**

```
sw o01 i02
```

```
sw o01 +
```

```
sw o* i02
```

swmode◆ **Function**

Enables/disables auto switching.

◆ **Syntax**

```
For VP1421: swmode plugin {auto|off}
```

```
For VP1420: swmode {auto|off}
```

volume

◆ **Functions and Syntax**

Syntax	Function
<code>volume</code>	Indicates the Total Volume and the volume for each input and output port.
<code>volume {i<input_port> i*}</code> <code>v<volume_number></code>	Configures the volume of a specified input/output port. This command is only supported by the VP1421.
<code>volume {o<output_port> o sys o*} v<volume_number></code>	

◆ **Parameters**

- ◆ `i<input_port>`: Specifies an input port in two digits.
- ◆ `i*`: Indicates all input ports.
- ◆ `o<output_port>`: Specifies an output port in two digits.
 - ◆ Output 1 (VGA/Audio In): `o01`
 - ◆ Output 2 (HDBaseT): `o02`
- ◆ `o*`: Indicates all output ports.
- ◆ `v<volume_number>`: Specifies the volume you wish to set to the specified audio port in two digits (01 - 10).

◆ **Examples**

```
volume i01 v10
```

```
volume o03 v05
```

Chapter 6

Video Presentation Control App

Overview

The ATEN Video Presentation Control App is designed to help you conveniently configure system settings to your VP1420 / VP1421 device.



Supported Systems

The ATEN Video Presentation Control App supports the following mobile operating systems:

Mobile Operating System	Supported Versions
Android	version 8.0 or later
iOS	version 12 or later

Installing and Configuring the App

1. Install the ATEN Video Presentation Control App on a mobile device.

- From the mobile device, tap the **App Store**  or **Google Play**  icon.
 - In the search box, type "ATEN Video Presentation Control App".
 - Tap **ATEN Video Presentation Control App** and install the app.
- Or,
- Scan the QR Code below to install the app.



2. From the mobile device, tap the **ATEN Video Presentation Control App** icon  .

Note: Make sure to connect the mobile device to the network where the VP1420 / VP1421 is installed.

iOS Version

Main Page

When logged in, the ATEN Video Presentation Control App defaults to the scanning page. Refer to the table below for an overview of the functions on each tab.

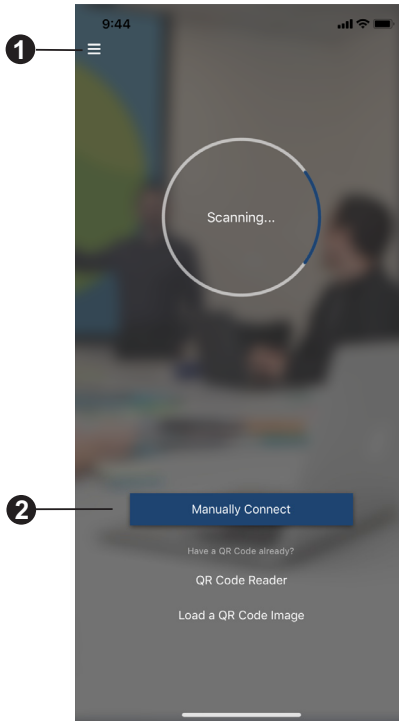

No.	Component	Description
1	Info 	Tap the info icon to show information such as version, privacy policy, and contact us.
2	Manually Connect	Tap this icon to manually connect and log in to the control panel by entering its IP address and password.
3	QR Code Reader	Tap this icon to scan a QR codes to join a meeting.

No.	Component	Description
4	Load a QR code Image	Tap this icon to upload a QR code image to join a meeting.

Info

Below screen is what the info page looks like. It shows the version, privacy policy and contact us. Tap on the **Contact Us** and it takes you straight to our ATEN's official website.



Logging in to the Control Panel

There are three ways to log in to the control panel through our ATEN Video Presentation Control App on VP1420 / VP1421. When the App is opened, it automatically scans for the device and available rooms to access. Or you can manually type in the IP address and password to log in to the control panel. Each methods are described below.

Logging in to the Control Panel Automatically

To automatically scan and log in to the control panel, follow the steps below.

1. Open the ATEN Video Presentation Control App and wait for the scanning process to finish.

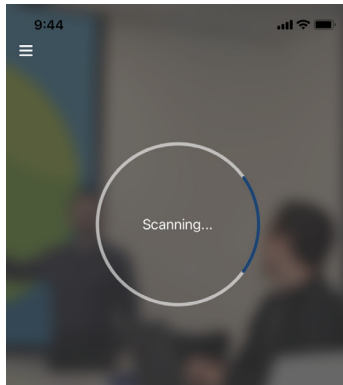

2. When the scanning finishes, the Room List page appears. Tap on a room to log in to the control panel.

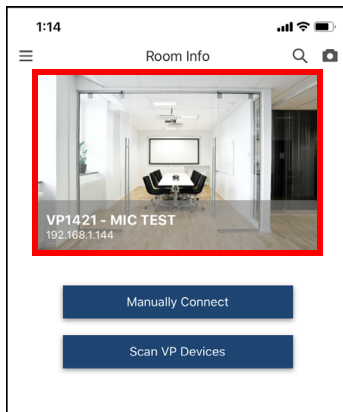

3. Enter the username and password, then tap **Login**.

Note: For security purposes, it is required to change the password from the VP1420 / VP1421 web console if you are logging in for the first time. For details, see *General Settings*, page 35.

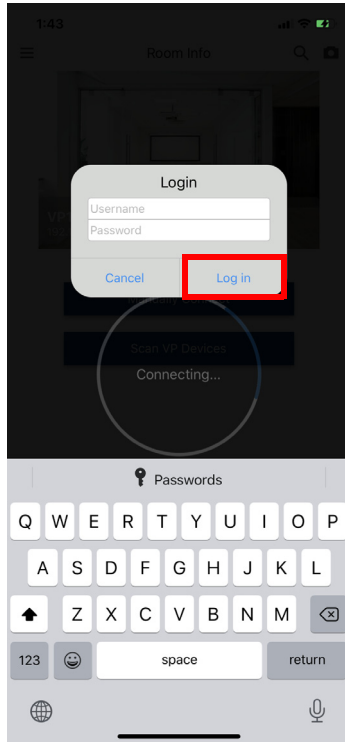

4. Now you have successfully logged in to the control panel.

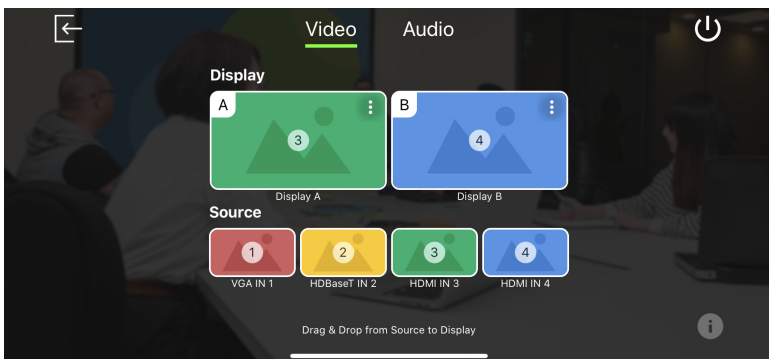

Logging in to the Control Panel via Manually Connect

To manually connect and log in to the control panel, follow the steps below.

1. Open the ATEN Video Presentation Control App and tap **Manually Connect**.

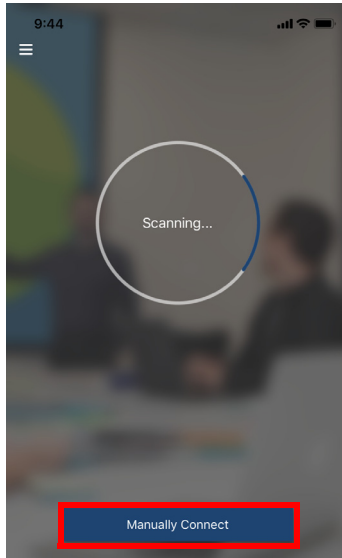

2. Enter the IP address of the VP1420 / VP1421 and tap **Connect**.

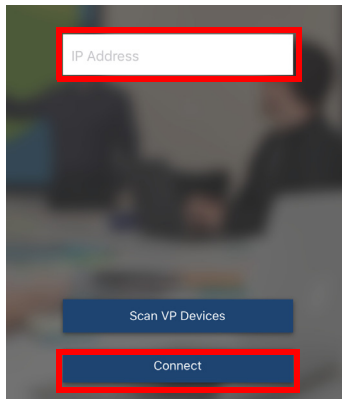

3. Enter the username and password, then tap **Log in**.

Note: For security purposes, it is required to change the password from the VP1420 / VP1421 web console if you are logging in for the first time. For details, see *General Settings*, page 35.

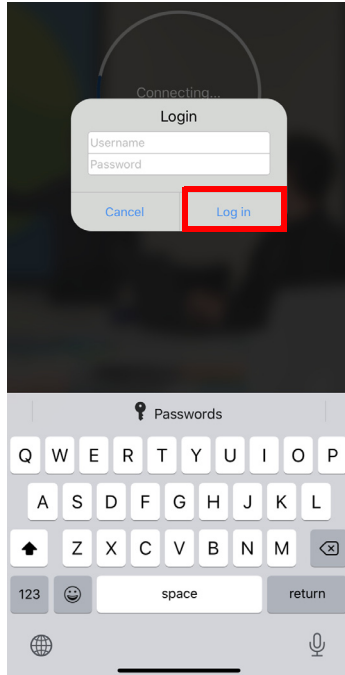

4. Now you have successfully logged in to the control panel.
- Or,
5. From the Room List page, tap **Manually Connect**.

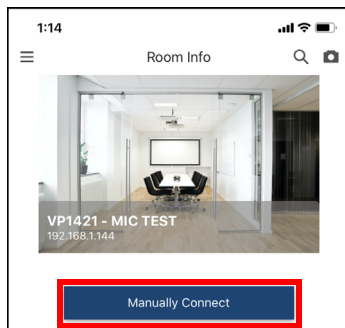

6. Enter the IP address of the VP1420 / VP1421 and tap **Connect**.

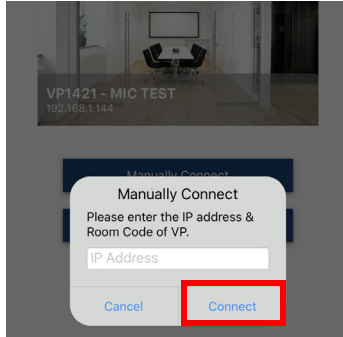

7. Enter the username and password, then tap **Log in**.

Note: For security purposes, it is required to change the password from the VP1420 / VP1421 web console if you are logging in for the first time. For details, see *General Settings*, page 35.

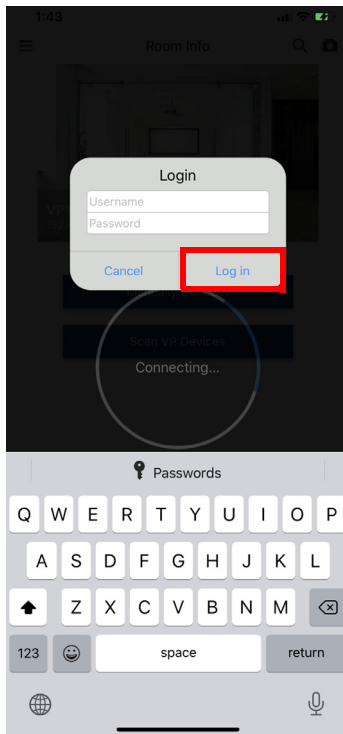

8. Now you have successfully logged in to the control panel.

Leaving the Meeting

To leave the control panel, follow the steps below.

1. Press the  from your main screen.

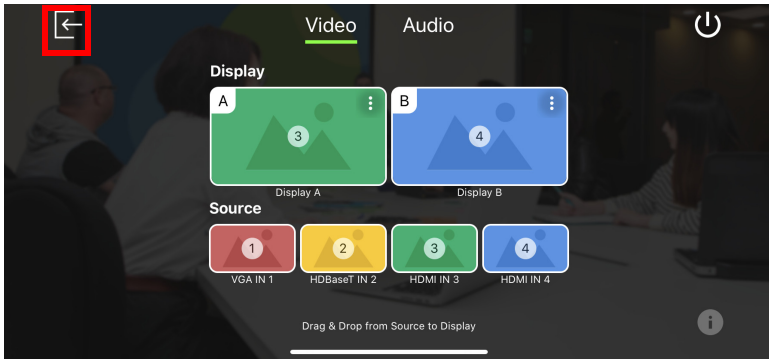

2. A warning screen appears, then tap **Leave**.

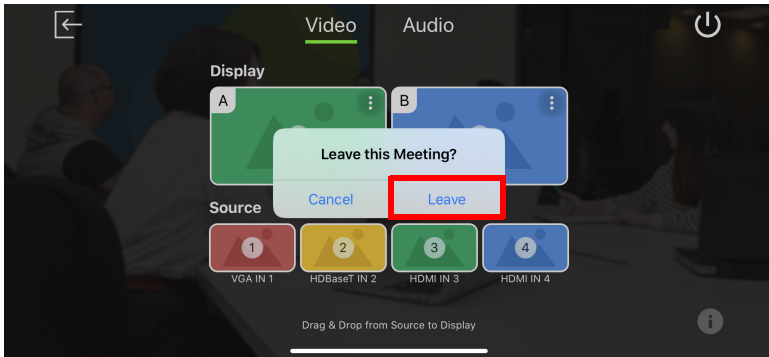

Enabling Standby Mode

To enable standby mode, follow the steps below.

1. Press the  from your main screen.

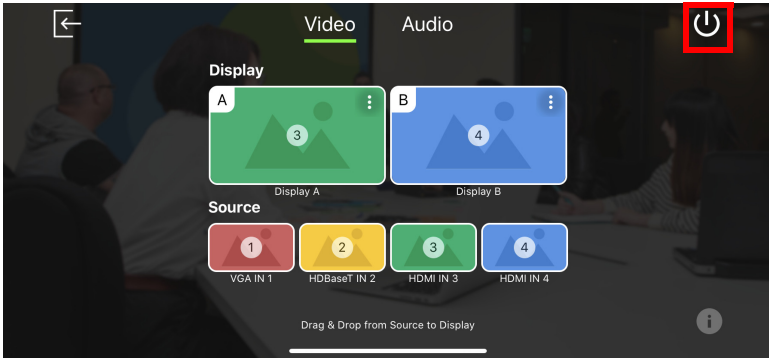

2. A warning screen appears, then tap **OK**.

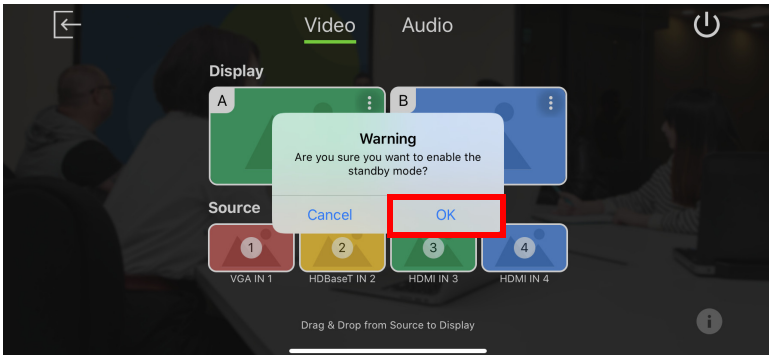

Checking the Firmware Version

To check the firmware version, follow the steps below.

1. Press the  from your main screen.

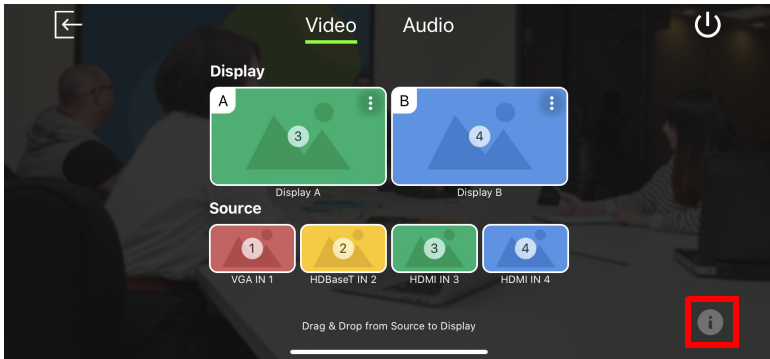

2. Below screen appears.

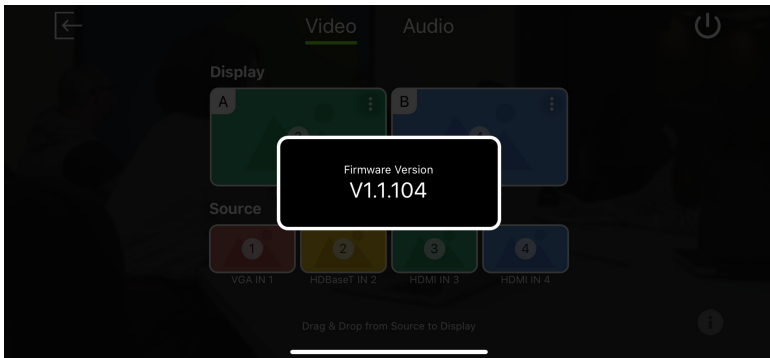

Video Panel

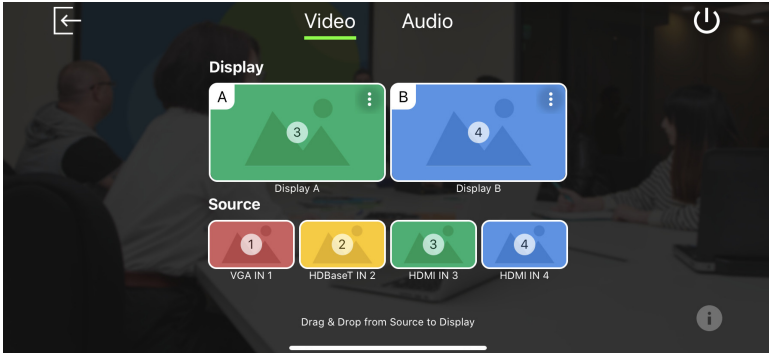

Switching a Source for a Display

To switch a source for a display, follow the steps below.

1. To switch Source 2 to Display A. From the display page, drag the Source to Display A.

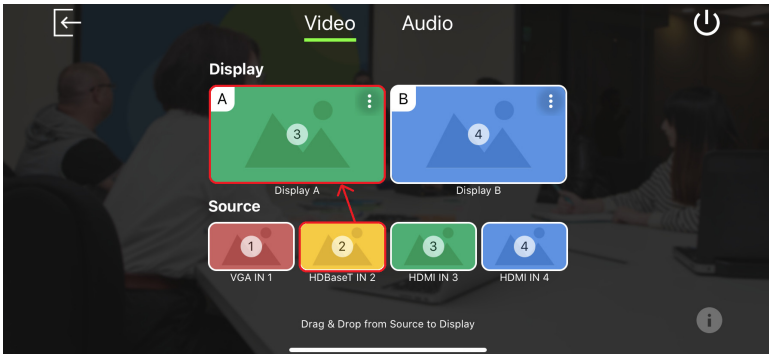

2. The Display A is now displaying content from Source 2.

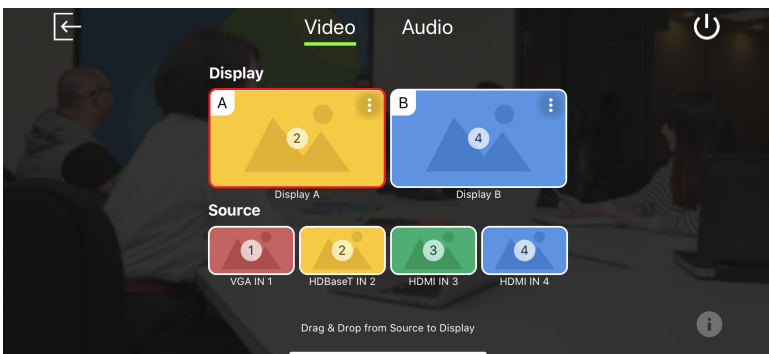

Display A Settings

To configure display settings for the display A, follow the steps below.

1. Tap  from the top right corner of the display A.

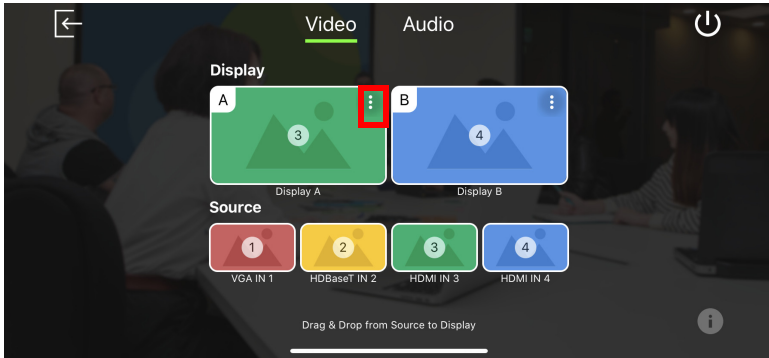

2. The below screen appears.

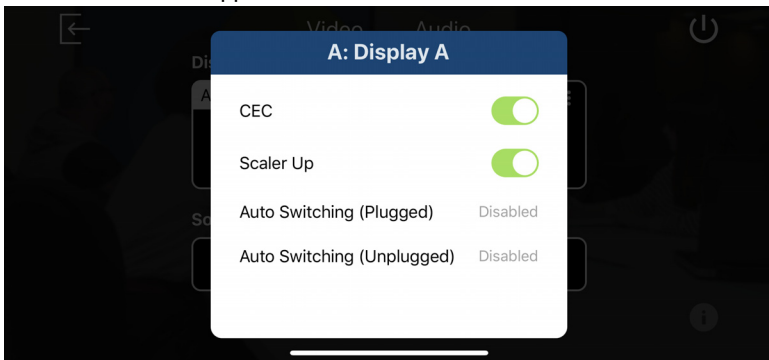

Tool	Description
CEC	Tap to enable or disable the CEC. The Consumer Electronics Control (CEC) allows for control of devices connected through HDMI ports to communicate with each other and makes the control of these devices using one remote control device possible. This setting is enabled by default.
Scaler Up	Tap to enable or disable the Scaler Up. The scaler up automatically scales the resolution of a 1080p source up to 4K. For a list of supported upscaling resolutions, see <i>Specifications</i> , page 103.

Tool	Description
Auto Switching (Plugged)	<p data-bbox="329 162 968 220">Tap to configure automatic switching of sources when a new source is plugged into the VP1420 / VP1421.</p> <ul data-bbox="329 236 968 331" style="list-style-type: none"><li data-bbox="329 236 968 264">◆ Disabled: Disable automatic switching.<li data-bbox="329 280 968 331">◆ Next: Automatically switch the display to the newly plugged-in source.
Auto Switching (Unplugged)	<p data-bbox="329 347 968 405">Tap to configure automatic switching of sources when a displayed source is unplugged.</p> <ul data-bbox="329 421 968 580" style="list-style-type: none"><li data-bbox="329 421 968 450">◆ Disabled: Disable automatic switching.<li data-bbox="329 466 968 523">◆ Next: Automatically switch the display to the next available source.<li data-bbox="329 539 968 580">◆ Last: Automatically switch the display to the previous available source based on the order of source connection. <p data-bbox="366 596 968 692">For example, if sources are connected to the VP1420 / VP1421 in the order of port 2, port 3, port 4 and then port 1, and that Display A is switched to port 3, when the source (port 3) is unplugged, Display A will automatically switch to port 2.</p>

Display B Settings

To configure display settings for the display B, follow the steps below.

1. Tap  from the top right corner of the display B.

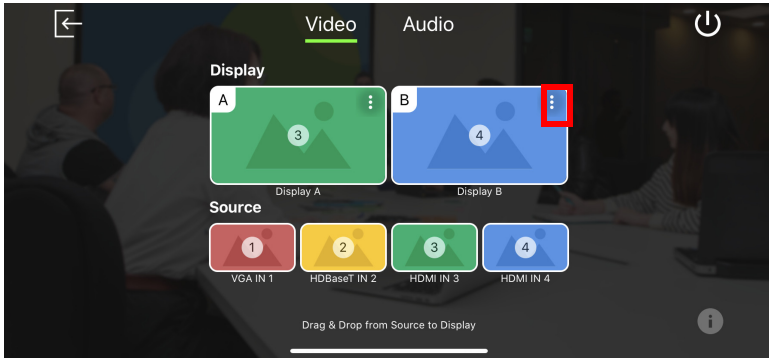

2. The below screen appears.

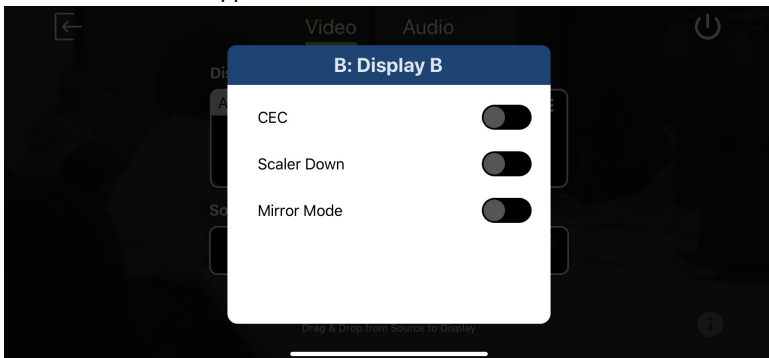

Tool	Description
CEC	Tap to enable or disable the CEC. The Consumer Electronics Control (CEC) allows for control of devices connected through HDMI ports to communicate with each other and makes the control of these devices using one remote control device possible. This setting is enabled by default.
Scaler Down	Tap to enable or disable the Scaler Down. The scaler down automatically scales the resolution of a 4K source down to 1080p. For a list of supported downscaling resolutions, see <i>Specifications</i> , page 103.
Mirror Mode	Tap to enable or disable the Mirror Mode. The mirror mode allows display B to show identical video content as display A.

Audio Panel

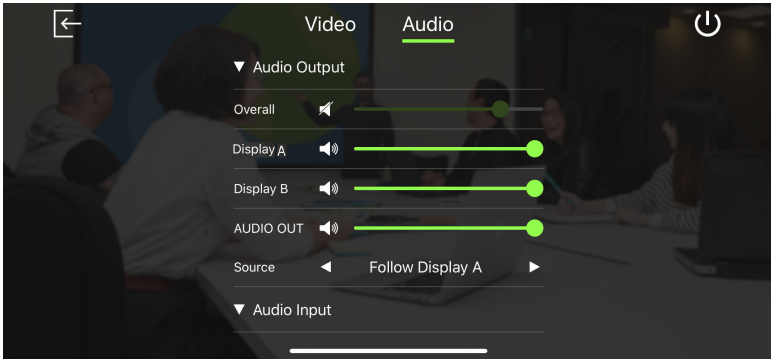



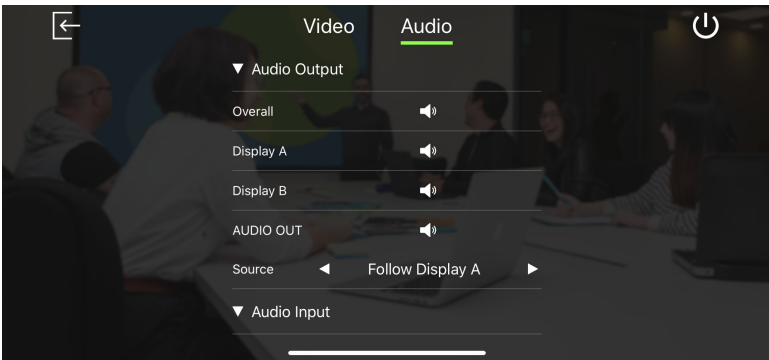



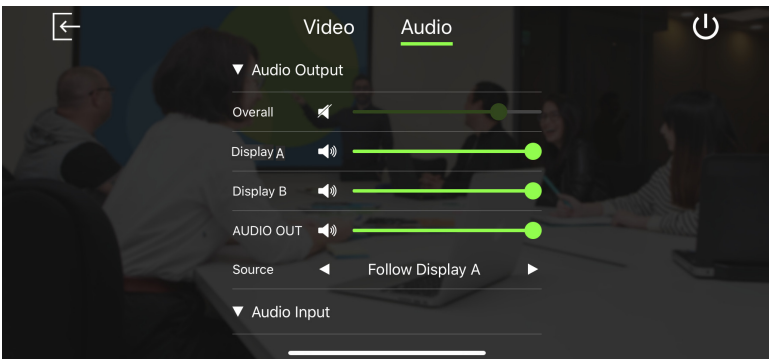

VP1420 Audio Output Settings



VP1421 Audio Output Settings





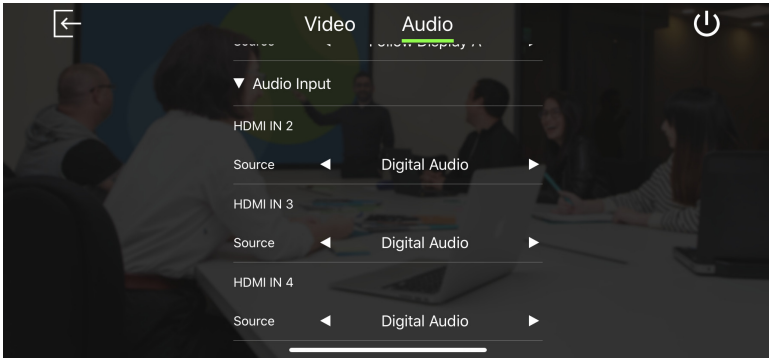

System Settings		Description
Note: Default settings are indicated in bold.		
Audio Output	Overall	<ul style="list-style-type: none"> ◆ Increase (+) ◆ Decrease (-) ◆ Mute <p>◆ VP1420: Tap  to mute or unmute the volume of the speaker connected to the VP1420.</p> <p>◆ VP1421: Sets the volume of the speaker connected to the VP1421 and tap  to mute or unmute.</p>
	Display A	<ul style="list-style-type: none"> ◆ Increase (+) ◆ Decrease (-) ◆ Mute <p>VP1420: Tap  to mute or unmute the volume of the display A connected to the VP1420.</p> <p>VP1421: Sets the volume of the display A connected to the VP1421 and tap  to mute or unmute.</p>
	Display B	<ul style="list-style-type: none"> ◆ Increase (+) ◆ Decrease (-) ◆ Mute <p>VP1420: Tap  to mute or unmute the volume of the display B connected to the VP1420.</p> <p>VP1421: Sets the volume of the display B connected to the VP1421 and tap  to mute or unmute.</p>
	AUDIO OUT	<ul style="list-style-type: none"> ◆ Increase (+) ◆ Decrease (-) ◆ Mute <p>VP1420: Tap  to mute or unmute the volume of the independent speaker connected to the Audio Out port on the VP1420.</p> <p>VP1421: Sets the volume of the independent speaker connected to the Audio Out port on the VP1421 and tap  to mute or unmute.</p>
	Source	<ul style="list-style-type: none"> ◆ Follow Display A ◆ Follow Display B ◆ Audio In <p>Sets the audio source for the independent speaker connected to the Audio Out port of the VP1420 / VP1421.</p>

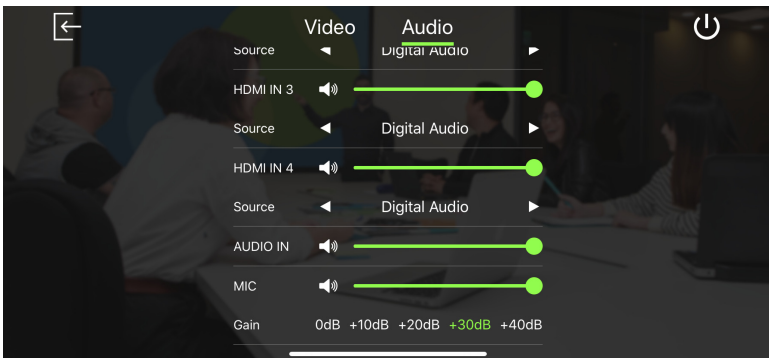
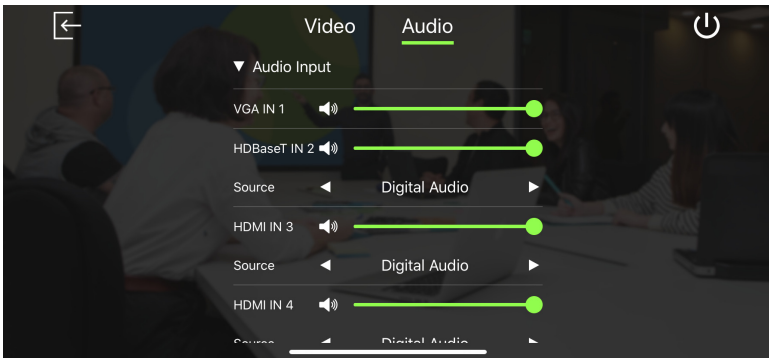

VP1420 Audio Input Settings





VP1421 Audio Input Settings



System Settings			Description
Note: Default settings are indicated in bold.			
Audio Input	VGA IN 1	<ul style="list-style-type: none"> ◆ Increase (+) ◆ Decrease (-) ◆ Mute 	VP1421 only: Sets the volume of the VGA source connected to the VP1421 and tap  to mute or unmute.
	HDBaseT IN 2	<ul style="list-style-type: none"> ◆ Increase (+) ◆ Decrease (-) ◆ Mute 	VP1421 only: Sets the volume of the HDBaseT source connected to the VP1421 and tap  to mute or unmute.
	Source	<ul style="list-style-type: none"> ◆ Digital Audio ◆ Embedded Audio In 	<p>VP1421 only: Sets the audio source for the HDBaseT source connected to the VP1421.</p> <p>To use the audio source that comes along with the video, select Digital Audio. To use the audio source from the independent audio source (connected to the Audio In port), select Embedded Audio In.</p>
	HDMI IN 2	<ul style="list-style-type: none"> ◆ Increase (+) ◆ Decrease (-) ◆ Mute 	VP1420 only: Sets the volume of the HDMI 2 source connected to the VP1420 and tap  to mute or unmute.
	Source	<ul style="list-style-type: none"> ◆ Digital Audio ◆ Embedded Audio In 	<p>VP1420 only: Sets the audio source for the HDMI 2 source connected to the VP1420.</p> <p>To use the audio source that comes along with the video, select Digital Audio. To use the audio source from the independent audio source (connected to the Audio In port), select Embedded Audio In.</p>

System Settings		Description
Note: Default settings are indicated in bold.		
HDMI IN 3	<ul style="list-style-type: none"> ◆ Increase (+) ◆ Decrease (-) ◆ Mute 	<p>VP1420: N/A.</p> <p>VP1421: Sets the volume of the HDMI 3 source connected to the HDMI 3 source connected to the VP1421 and tap  to mute or unmute.</p>
Source	<ul style="list-style-type: none"> ◆ Digital Audio ◆ Embedded Audio In 	<p>VP1420: Sets the audio source for the HDMI 3 source connected to the VP1420.</p> <p>VP1421: Sets the audio source for the HDMI 3 source connected to the VP1421.</p> <p>To use the audio source that comes along with the video, select Digital Audio. To use the audio source from the independent audio source (connected to the Audio In port), select Embedded Audio In.</p>
HDMI IN 4	<ul style="list-style-type: none"> ◆ Increase (+) ◆ Decrease (-) ◆ Mute 	<p>VP1420: N/A.</p> <p>VP1421: Sets the volume of the HDMI 4 source connected to the HDMI 4 source connected to the VP1421 and tap  to mute or unmute.</p>
Source	<ul style="list-style-type: none"> ◆ Digital Audio ◆ Embedded Audio In 	<p>VP1420: Sets the audio source for the HDMI 4 source connected to the VP1420.</p> <p>VP1421: Sets the audio source for the HDMI 4 source connected to the VP1421.</p> <p>To use the audio source that comes along with the video, select Digital Audio. To use the audio source from the independent audio source (connected to the Audio In port), select Embedded Audio In.</p>

System Settings		Description
Note: Default settings are indicated in bold.		
AUDIO In	<ul style="list-style-type: none"> ◆ Increase (+) ◆ Decrease (-) ◆ Mute 	VP1421 only: Sets the volume of the independent audio source connected to the Audio In port on the VP1421 and tap  to mute or unmute.
MIC	<ul style="list-style-type: none"> ◆ Increase (+) ◆ Decrease (-) ◆ Mute 	VP1421 only: Sets the volume of the microphone connected to the MIC port on VP1421 and tap  to mute or unmute.
Gain	<ul style="list-style-type: none"> ◆ +0dB ◆ +10dB ◆ +20dB ◆ +30dB 	VP1421 only: Sets the MIC gain of the microphone connected to the VP1421.

Android Version

Main Page

When logged in, the ATEN Video Presentation Control App defaults to the scanning page. Refer to the table below for an overview of the functions on each tab.

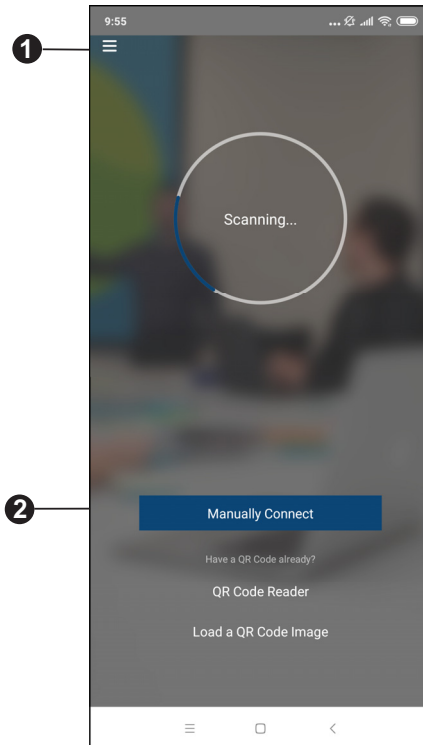

No.	Component	Description
1	Info 	Tap the info icon to show information such as version, privacy policy, and contact us.
2	Manually Connect	Tap this icon to manually connect and log in to the control panel by entering its IP address and password.
3	QR Code Reader	Tap this icon to scan a QR codes to join a meeting.

No.	Component	Description
4	Load a QR code Image	Tap this icon to upload a QR code image to join a meeting.

Info

Below screen is what the info page looks like, it shows the version, privacy policy and contact us. Tap on the **Contact Us** and it takes you straight to our ATEN's official website.

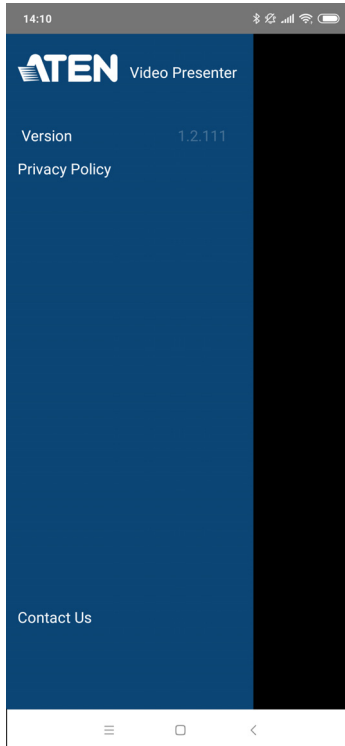

Logging in to the Control Panel

There are three ways to log in to the control panel through our ATEN Video Presentation Control App on VP1420 / VP1421. When the App is opened, it automatically scans for the device and available rooms to access. Or you can manually type in the IP address and password to log in to the control panel. Each methods are described below.

Logging in to the Control Panel Automatically

To automatically scan and log in to the control panel, follow the steps below.

1. Open the ATEN Video Presentation Control App and wait for the scanning process to finish.

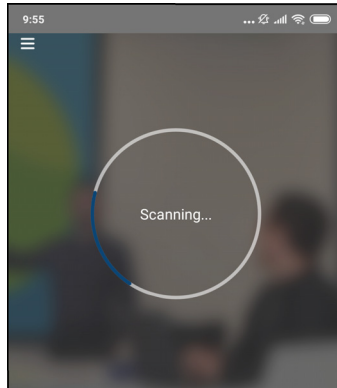

2. When the scanning finishes, the Room List page appears. Tap on a room to log in to the control panel.

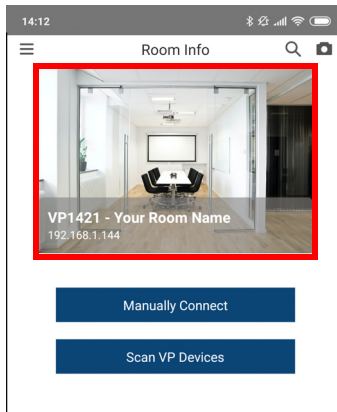

3. Enter the username and password, then tap **Log in**.

Note: For security purposes, it is required to change the password from the VP1420 / VP1421 web console if you are logging in for the first time. For details, see *General Settings*, page 35.

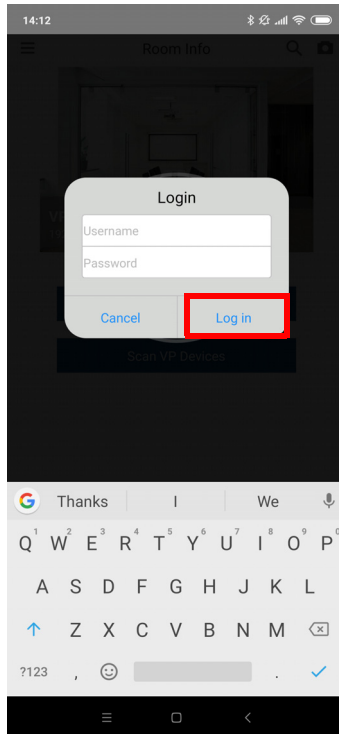

4. Now you have successfully logged in to the control panel.

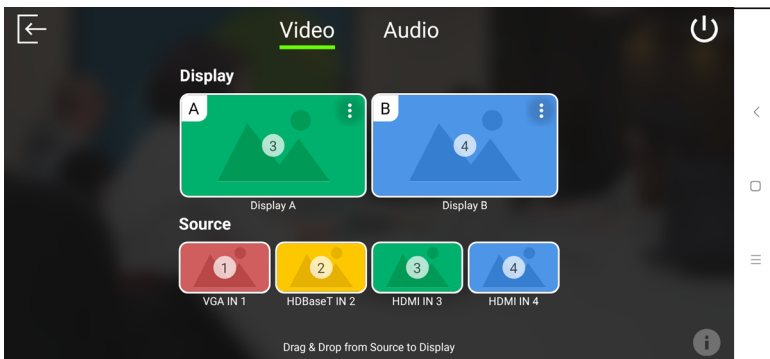

Logging in to the Control Panel via Manually Connect

To manually connect and log in to the control panel, follow the steps below.

1. Open the ATEN Video Presentation Control App and tap **Manually Connect**.

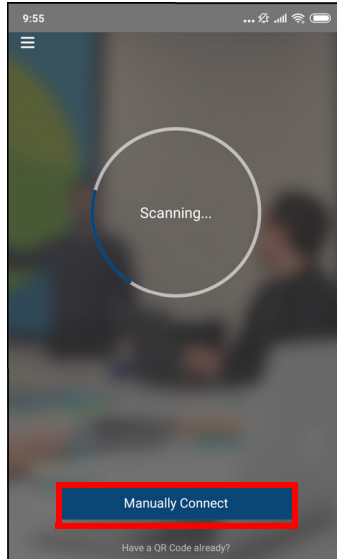

2. Enter the IP address of the VP1420 / VP1421 and tap **Connect**.

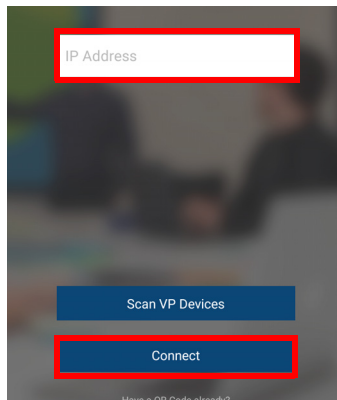

3. Enter the username and password, then tap **Log in**.

Note: For security purposes, it is required to change the password from the VP1420 / VP1421 web console if you are logging in for the first time. For details, see *General Settings*, page 35.

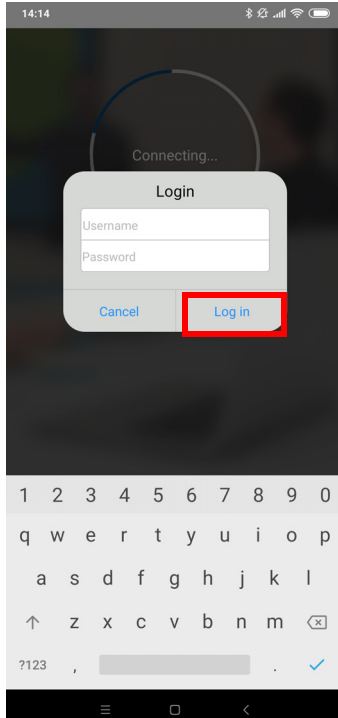

4. Now you have successfully logged in to the control panel.

Or,

5. From the Room List page, tap **Manually Connect**.

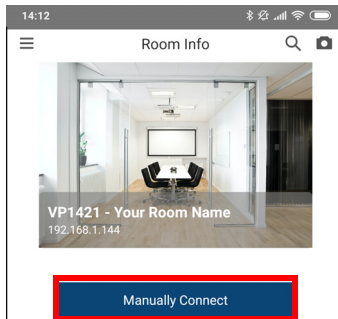

6. Enter the IP address of the VP1420 / VP1421 and tap **Connect**.

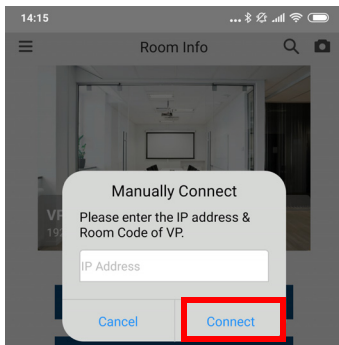

7. Enter the username and password, then tap **Log in**.

Note: For security purposes, it is required to change the password from the VP1420 / VP1421 web console if you are logging in for the first time. For details, see *General Settings*, page 35.

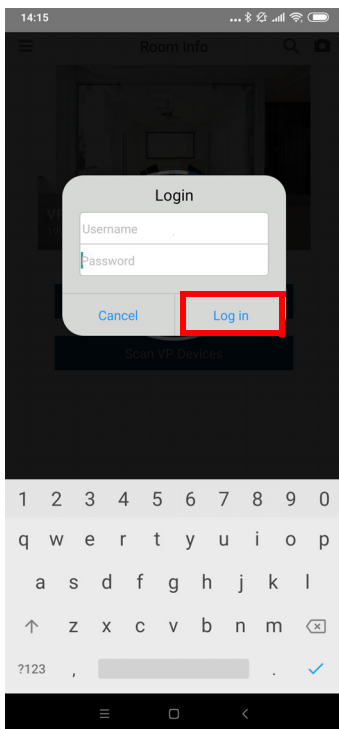

8. Now you have successfully logged in to the control panel.

Leaving the Meeting

To leave the control panel, follow the steps below.

1. Press the  from your main screen.

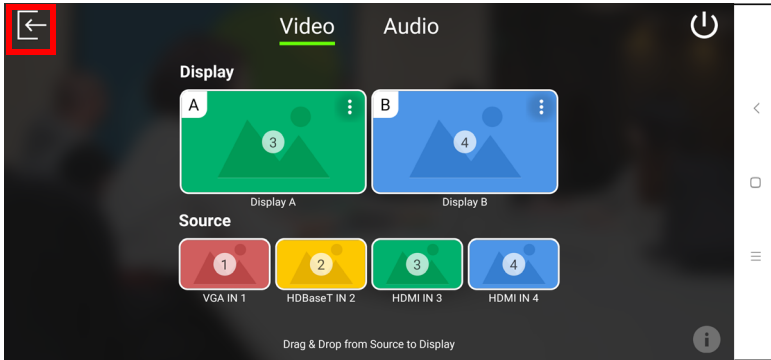

2. A warning screen appears, then tap **Leave**.

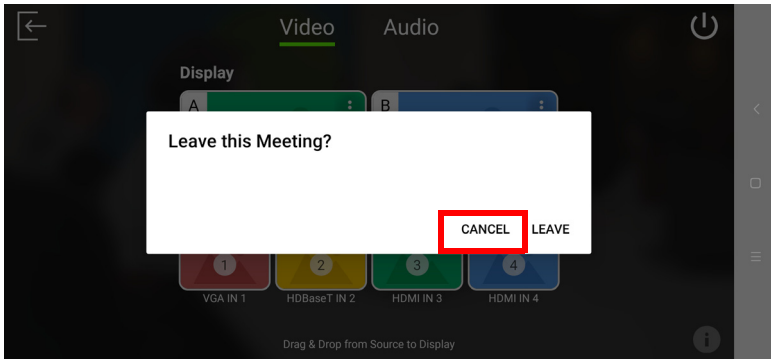

Enabling Standby Mode

To enable standby mode, follow the steps below.

1. Press the  from your main screen.

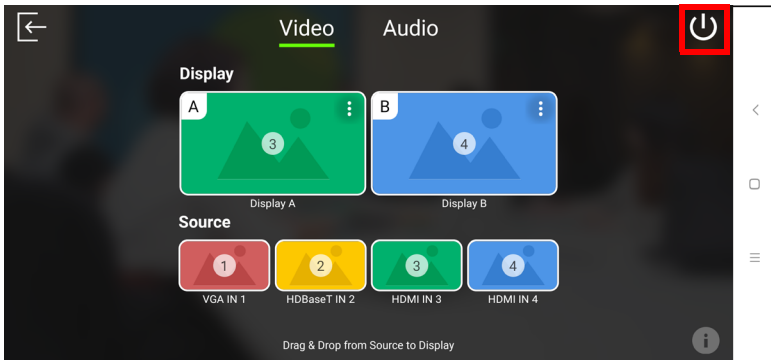

2. A warning screen appears, then tap **OK**.

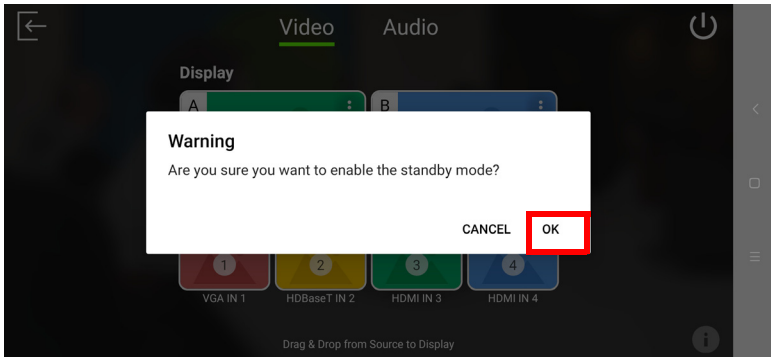

Checking the Firmware Version

To check the firmware version, follow the steps below.

1. press the  from your main screen.

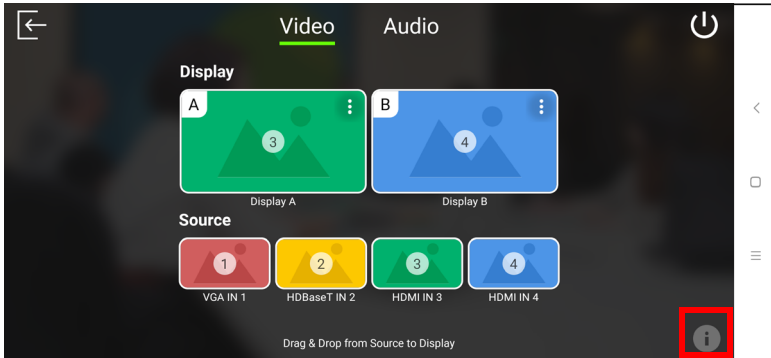

2. Below screen appears.

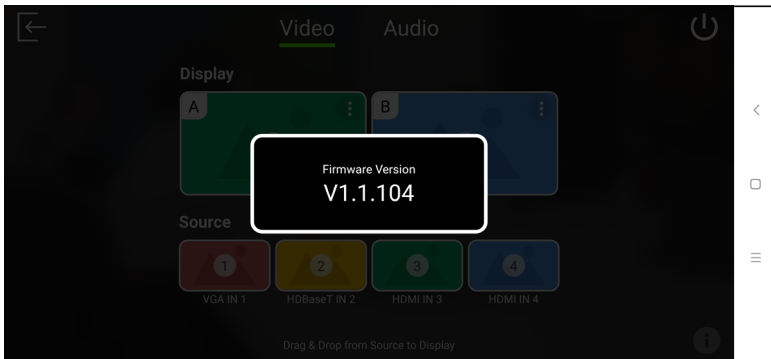

Video Panel

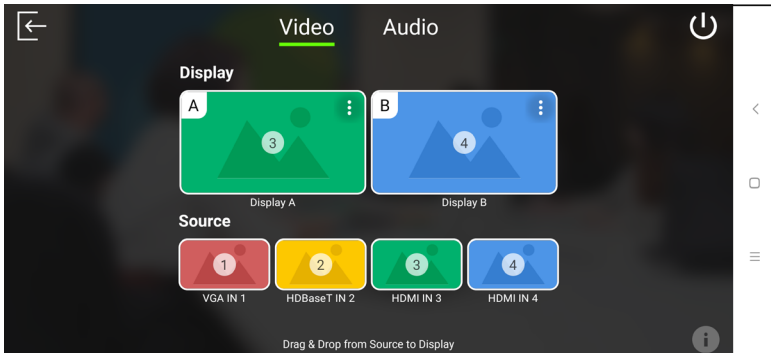

Switching a Source for a Display

To switch a source for a display, follow the steps below.

1. To switch Source 2 to Display A. From the display page, drag the Source to Display A.

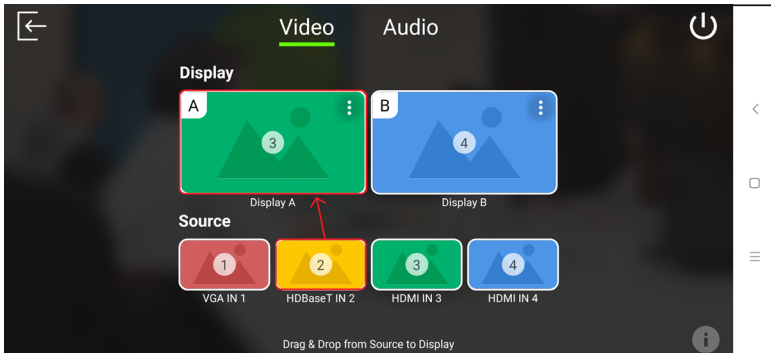

2. The Display A is now displaying content from Source 2.

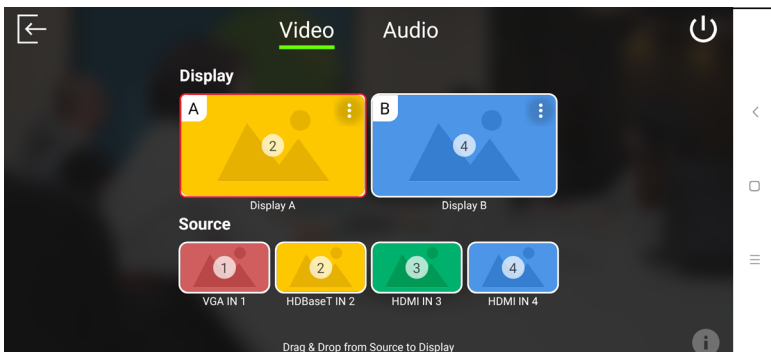

Display A Settings

To configure display settings for the display A, follow the steps below.

1. Tap  from the top right corner of the display A.

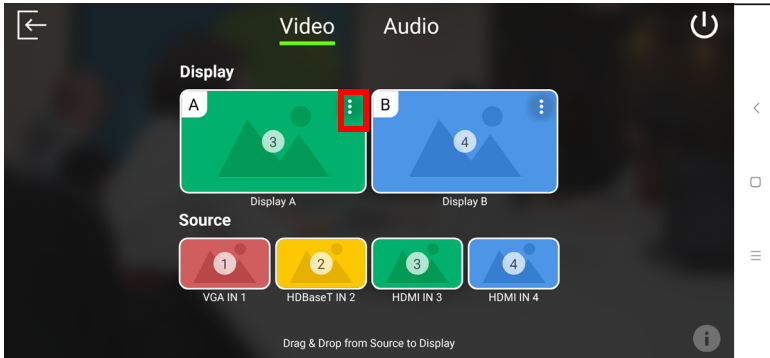

2. The below screen appears.

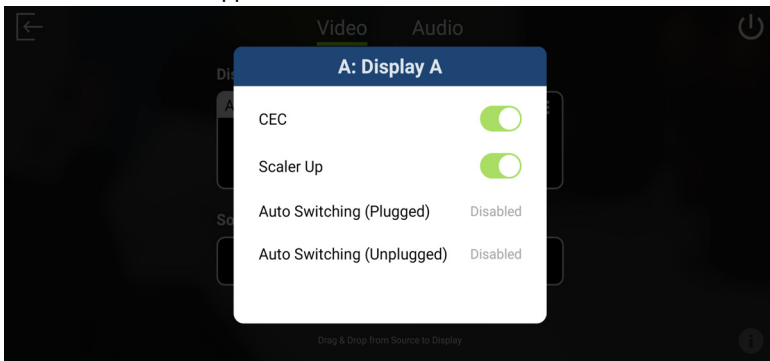

Tool	Description
CEC	Tap to enable or disable the CEC. The Consumer Electronics Control (CEC) allows for control of devices connected through HDMI ports to communicate with each other and makes the control of these devices using one remote control device possible. This setting is enabled by default.
Scaler Up	Tap to enable or disable the Scaler Up. The scaler up automatically scales the resolution of a 1080p source up to 4K. For a list of supported upscaling resolutions, see <i>Specifications</i> , page 103.

Tool	Description
Auto Switching (Plugged)	Tap to configure automatic switching of sources when a new source is plugged into the VP1420 / VP1421. <ul style="list-style-type: none"> ◆ Disabled: Disable automatic switching. ◆ Next: Automatically switch the display to the newly plugged-in source.
Auto Switching (Unplugged)	Tap to configure automatic switching of sources when a displayed source is unplugged. <ul style="list-style-type: none"> ◆ Disabled: Disable automatic switching. ◆ Next: Automatically switch the display to the next available source. ◆ Last: Automatically switch the display to the previous available source based on the order of source connection. For example, if sources are connected to the VP1420 / VP1421 in the order of port 2, port 3, port 4 and then port 1, and that Display A is switched to port 3, when the source (port 3) is unplugged, Display A will automatically switch to port 2.

Auto Switching

To enable or disable auto switching for newly detected source, tap on the **Auto Switching**, and the screen below appears.

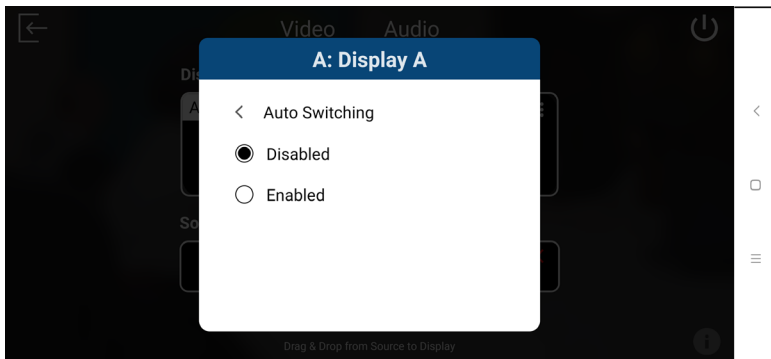

Display B Settings

To configure display settings for the display B, follow the steps below.

1. Tap  from the top right corner of the display B.

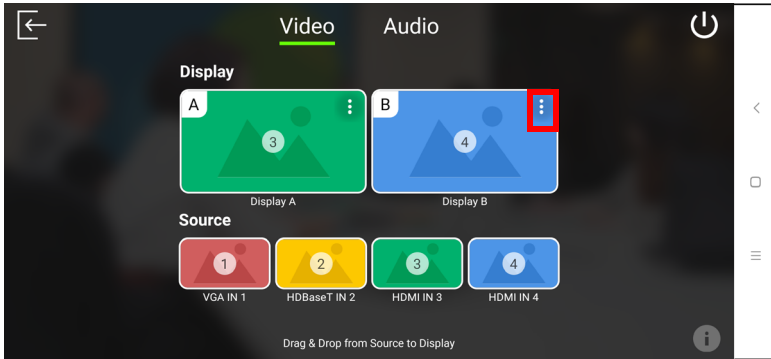

2. The below screen appears.

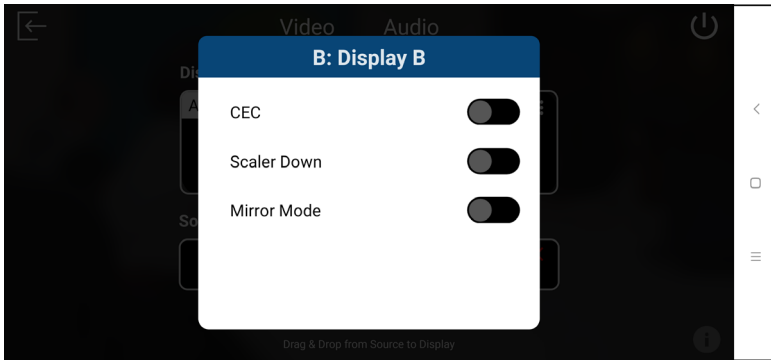

Tool	Description
CEC	Tap to enable or disable the CEC. The Consumer Electronics Control (CEC) allows for control of devices connected through HDMI ports to communicate with each other and makes the control of these devices using one remote control device possible. This setting is enabled by default.
Scaler Down	Tap to enable or disable the Scaler Down. The scaler down automatically scales the resolution of a 4K source down to 1080p. For a list of supported downscaling resolutions, see <i>Specifications</i> , page 103.
Mirror Mode	Tap to enable or disable the Mirror Mode. The mirror mode allows display B to show identical video content as display A.

Audio Panel

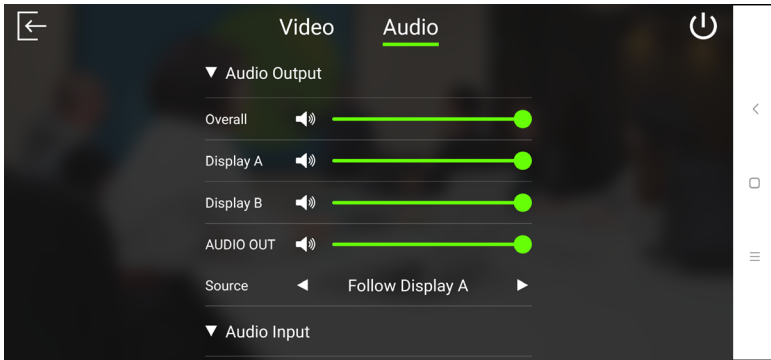



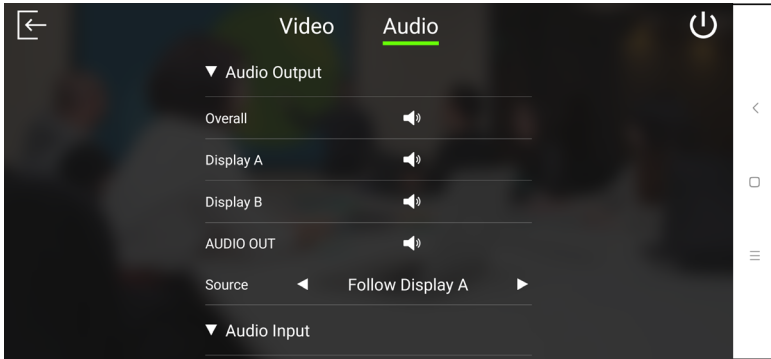



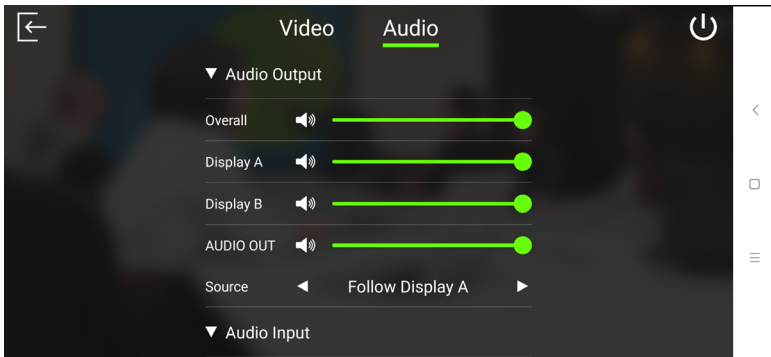

VP1420 Audio Output Settings



VP1421 Audio Output Settings



System Settings		Description
Note: Default settings are indicated in bold.		
Audio Output	Overall	<ul style="list-style-type: none"> ◆ Increase (+) ◆ Decrease (-) ◆ Mute <p>◆ VP1420: Tap  to mute or unmute the volume of the speaker connected to the VP1420.</p> <p>◆ VP1421: Sets the volume of the speaker connected to the VP1421 and tap  to mute or unmute.</p>
	Display A	<ul style="list-style-type: none"> ◆ Increase (+) ◆ Decrease (-) ◆ Mute <p>VP1420: Tap  to mute or unmute the volume of the display A connected to the VP1420.</p> <p>VP1421: Sets the volume of the display A connected to the VP1421 and tap  to mute or unmute.</p>
	Display B	<ul style="list-style-type: none"> ◆ Increase (+) ◆ Decrease (-) ◆ Mute <p>VP1420: Tap  to mute or unmute the volume of the display B connected to the VP1420.</p> <p>VP1421: Sets the volume of the display B connected to the VP1421 and tap  to mute or unmute.</p>
	AUDIO OUT	<ul style="list-style-type: none"> ◆ Increase (+) ◆ Decrease (-) ◆ Mute <p>VP1420: Tap  to mute or unmute the volume of the independent speaker connected to the Audio Out port on the VP1420.</p> <p>VP1421: Sets the volume of the independent speaker connected to the Audio Out port on the VP1421 and tap  to mute or unmute.</p>

System Settings		Description
Note: Default settings are indicated in bold.		
Source	<ul style="list-style-type: none"> ◆ Follow Display A ◆ Follow Display B ◆ Audio In 	Sets the audio source for the independent speaker connected to the Audio Out port of the VP1420 / VP1421.

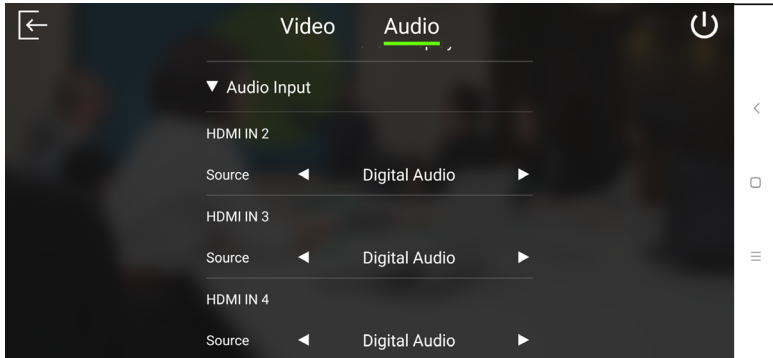

VP1420 Audio Input Settings



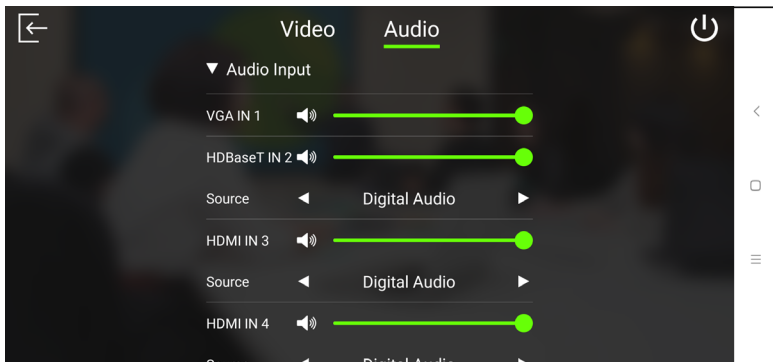

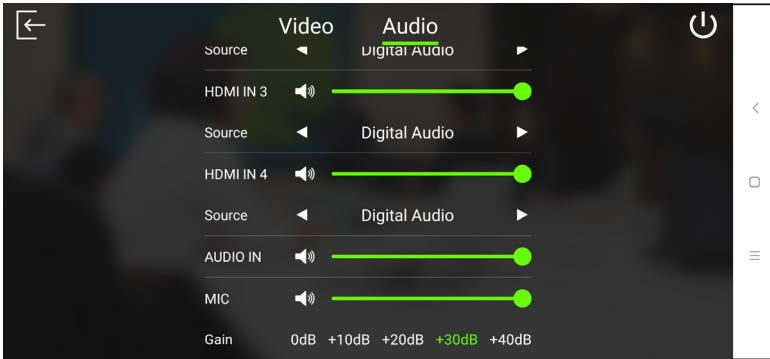

VP1421 Audio Input Settings





System Settings			Description
Note: Default settings are indicated in bold.			
Audio Input	VGA IN 1	<ul style="list-style-type: none"> ◆ Increase (+) ◆ Decrease (-) ◆ Mute 	VP1421 only: Sets the volume of the VGA source connected to the VP1421 and tap  to mute or unmute.
	HDBaseT IN 2	<ul style="list-style-type: none"> ◆ Increase (+) ◆ Decrease (-) ◆ Mute 	VP1421 only: Sets the volume of the HDBaseT source connected to the VP1421 and tap  to mute or unmute.
	Source	<ul style="list-style-type: none"> ◆ Digital Audio ◆ Embedded Audio In 	<p>VP1421 only: Sets the audio source for the HDBaseT source connected to the VP1421.</p> <p>To use the audio source that comes along with the video, select Digital Audio. To use the audio source from the independent audio source (connected to the Audio In port), select Embedded Audio In.</p>
	HDMI IN 2	<ul style="list-style-type: none"> ◆ Increase (+) ◆ Decrease (-) ◆ Mute 	VP1420 only: Sets the volume of the HDMI 2 source connected to the VP1420 and tap  to mute or unmute.

System Settings		Description
Note: Default settings are indicated in bold.		
	Source	<ul style="list-style-type: none"> ◆ Digital Audio ◆ Embedded Audio In <p>VP1420 only: Sets the audio source for the HDMI 2 source connected to the VP1420.</p> <p>To use the audio source that comes along with the video, select Digital Audio. To use the audio source from the independent audio source (connected to the Audio In port), select Embedded Audio In.</p>
	HDMI IN 3	<ul style="list-style-type: none"> ◆ Increase (+) ◆ Decrease (-) ◆ Mute <p>VP1420: N/A. VP1421: Sets the volume of the HDMI 3 source connected to the VP1421 and tap  to mute or unmute.</p>
	Source	<ul style="list-style-type: none"> ◆ Digital Audio ◆ Embedded Audio In <p>VP1420: Sets the audio source for the HDMI 3 source connected to the VP1420. VP1421: Sets the audio source for the HDMI 3 source connected to the VP1421.</p> <p>To use the audio source that comes along with the video, select Digital Audio. To use the audio source from the independent audio source (connected to the Audio In port), select Embedded Audio In.</p>
	HDMI IN 4	<ul style="list-style-type: none"> ◆ Increase (+) ◆ Decrease (-) ◆ Mute <p>VP1420: N/A. VP1421: Sets the volume of the HDMI 4 source connected to the VP1421 and tap  to mute or unmute.</p>

System Settings		Description
Note: Default settings are indicated in bold.		
Source	<ul style="list-style-type: none"> ◆ Digital Audio ◆ Embedded Audio In 	<p>VP1420: Sets the audio source for the HDMI 4 source connected to the VP1420.</p> <p>VP1421: Sets the audio source for the HDMI 4 source connected to the VP1421.</p> <p>To use the audio source that comes along with the video, select Digital Audio. To use the audio source from the independent audio source (connected to the Audio In port), select Embedded Audio In.</p>
AUDIO In	<ul style="list-style-type: none"> ◆ Increase (+) ◆ Decrease (-) ◆ Mute 	<p>VP1421 only: Sets the volume of the independent audio source connected to the Audio In port on the VP1421 and tap  to mute or unmute.</p>
MIC	<ul style="list-style-type: none"> ◆ Increase (+) ◆ Decrease (-) ◆ Mute 	<p>VP1421 only: Sets the volume of the microphone connected to the MIC port on VP1421 and tap  to mute or unmute.</p>
Gain	<ul style="list-style-type: none"> ◆ +0dB ◆ +10dB ◆ +20dB ◆ +30dB 	<p>VP1421 only: Sets the MIC gain of the microphone connected to the VP1421.</p>

Safety Instructions

General

- ◆ This product is for indoor use only.
- ◆ Read all of these instructions. Save them for future reference.
- ◆ Follow all warnings and instructions marked on the device.
- ◆ Do not place the device on any unstable surface (cart, stand, table, etc.). If the device falls, serious damage will result.
- ◆ Do not use the device near water.
- ◆ Do not place the device near, or over, radiators or heat registers.
- ◆ The device cabinet is provided with slots and openings to allow for adequate ventilation. To ensure reliable operation, and to protect against overheating, these openings must never be blocked or covered.
- ◆ The device should never be placed on a soft surface (bed, sofa, rug, etc.) as this will block its ventilation openings. Likewise, the device should not be placed in a built in enclosure unless adequate ventilation has been provided.
- ◆ Never spill liquid of any kind on the device.
- ◆ Unplug the device from the wall outlet before cleaning. Do not use liquid or aerosol cleaners. Use a damp cloth for cleaning.
- ◆ The device should be operated from the type of power source indicated on the marking label. If you are not sure of the type of power available, consult your dealer or local power company.
- ◆ The device is designed for IT power distribution systems with 230V phase-to-phase voltage.
- ◆ To prevent damage to your installation it is important that all devices are properly grounded.
- ◆ The device is equipped with a 3-wire grounding type plug. This is a safety feature. If you are unable to insert the plug into the outlet, contact your electrician to replace your obsolete outlet. Do not attempt to defeat the purpose of the grounding-type plug. Always follow your local/national wiring codes.

- ◆ Do not allow anything to rest on the power cord or cables. Route the power cord and cables so that they cannot be stepped on or tripped over.
- ◆ If an extension cord is used with this device make sure that the total of the ampere ratings of all products used on this cord does not exceed the extension cord ampere rating. Make sure that the total of all products plugged into the wall outlet does not exceed 15 amperes.
- ◆ To help protect your system from sudden, transient increases and decreases in electrical power, use a surge suppressor, line conditioner, or uninterruptible power supply (UPS).
- ◆ Position system cables and power cables carefully; Be sure that nothing rests on any cables.
- ◆ Never push objects of any kind into or through cabinet slots. They may touch dangerous voltage points or short out parts resulting in a risk of fire or electrical shock.
- ◆ Do not attempt to service the device yourself. Refer all servicing to qualified service personnel.
- ◆ If the following conditions occur, unplug the device from the wall outlet and bring it to qualified service personnel for repair.
 - ◆ The power cord or plug has become damaged or frayed.
 - ◆ Liquid has been spilled into the device.
 - ◆ The device has been exposed to rain or water.
 - ◆ The device has been dropped, or the cabinet has been damaged.
 - ◆ The device exhibits a distinct change in performance, indicating a need for service.
 - ◆ The device does not operate normally when the operating instructions are followed.
- ◆ Only adjust those controls that are covered in the operating instructions. Improper adjustment of other controls may result in damage that will require extensive work by a qualified technician to repair.

Rack Mounting

- ◆ Before working on the rack, make sure that the stabilizers are secured to the rack, extended to the floor, and that the full weight of the rack rests on the floor. Install front and side stabilizers on a single rack or front stabilizers for joined multiple racks before working on the rack.
- ◆ Always load the rack from the bottom up, and load the heaviest item in the rack first.
- ◆ Make sure that the rack is level and stable before extending a device from the rack.
- ◆ Use caution when pressing the device rail release latches and sliding a device into or out of a rack; the slide rails can pinch your fingers.
- ◆ Do not overload the AC supply branch circuit that provides power to the rack. The total rack load should not exceed 80 percent of the branch circuit rating.
- ◆ Make sure that all equipment used on the rack – including power strips and other electrical connectors – is properly grounded.
- ◆ Ensure that proper airflow is provided to devices in the rack.
- ◆ Ensure that the operating ambient temperature of the rack environment does not exceed the maximum ambient temperature specified for the equipment by the manufacturer.
- ◆ Do not step on or stand on any device when servicing other devices in a rack.

Technical Support

International

- ◆ For online technical support – including troubleshooting, documentation, and software updates: <http://support.aten.com>
- ◆ For telephone support, call this number:

International	886-2-8692-6959
China	86-400-810-0-810
Japan	81-3-5615-5811
Korea	82-2-467-6789
North America	1-888-999-ATEN ext 4988 1-949-428-1111

North America

Email Support		support@aten-usa.com
Online Technical Support	Troubleshooting Documentation Software Updates	http://www.aten-usa.com/support
Telephone Support		1-888-999-ATEN ext 4988

When you contact us, please have the following information ready beforehand:

- ◆ Product model number, serial number, and date of purchase
- ◆ Your computer configuration, including operating system, revision level, expansion cards, and software
- ◆ Any error messages displayed at the time the error occurred
- ◆ The sequence of operations that led up to the error
- ◆ Any other information you feel may be of help

Specifications

VP1420

Video Input	
Interfaces	3 x HDMI Type-A female (Black) 1 x VGA (HDB-15) female (Blue)
Max. Distance	HDMI: <ul style="list-style-type: none"> ◆ 4K@60Hz (4:4:4) up to 3m ◆ 4K@30Hz up to 10m ◆ 1080p@60Hz up to 15m VGA: <ul style="list-style-type: none"> ◆ 1080p@60Hz up to 15m
Video Output	
Interfaces	2 x HDMI Type-A female (Black) HDBaseT: 1 x RJ-45 female (Silver)
Max. Distance	HDMI: <ul style="list-style-type: none"> ◆ 4K@60Hz (4:4:4) up to 3m ◆ 4K@30Hz up to 10m ◆ 1080p@60Hz up to 15m
Video	
Max. Resolution	HDMI: Up to 4096 x 2160 / 3840 x 2160 @ 60Hz (4:4:4) VGA: Up to 1080p @60Hz
Supported Upscaling & Downscaling Resolutions	Upscaling resolutions: <ul style="list-style-type: none"> ◆ 1080p 60Hz to 4K 60Hz ◆ 1080p 50Hz to 4K 50Hz ◆ 1080p 24Hz to 4K 24Hz ◆ 1080p 25Hz to 4K 25Hz ◆ 1080p 30Hz to 4K 30Hz Downscaling resolutions: <ul style="list-style-type: none"> ◆ 4K 60Hz to 1080p 60Hz ◆ 4K 50Hz to 1080p 50Hz ◆ 4K 24Hz to 1080p 24Hz ◆ 4K 25Hz to 1080p 25Hz ◆ 4K 30Hz to 1080p 30Hz <p>Note: When videos of 4096 x 2160 in resolution are downscaled, the output will be cropped by 128 pixels in width on both the left and right.</p>

Compliance	HDMI 2.0 (3D, Deep Color, 4K); 4K HDR HDCP 2.2 compatible; Consumer Electronics Control (CEC)
Audio	
Input	Stereo audio (VGA): 1 x mini stereo jack female (Green) Stereo audio (HDMI): 1 x mini stereo jack female (Green)
Output	Line Out (Unbalanced): 1 x captive screw connector, 3-pole
Control	
RS-232	1 x captive screw connector, 3-pole
IR	1 x mini stereo jack female (Black)
Ethernet	1 x RJ-45 female (Silver)
Contact In	1 x captive screw connector, 5-pole
LED Out	1 x captive screw connector, 5-pole; LED out power: +5 VDC, 0.2 A
Switches	
Power	1 x Pushbutton (LED: Green/Orange)
Video Input Port Selection	4 x Pushbuttons (LED: Green)
Video Output Port Selection	2 x Pushbuttons (LED: Orange)
Selection	Mute: 1 x Pushbutton Mode/Unlock: 1 x Pushbutton
EDID Mode	ATEN Default, Display A, Remix
Connectors	
Power	1 x DC jack (Black)
Power Consumption	DC 5V, 7.21W
Environmental	
Operating Temperature	0 - 40°C
Storage Temperature	-20 - 60°C
Humidity	0 x 80% RH, Non-Condensing
Physical Properties	
Housing	Metal
Weight	1.09 kg (2.40 lb)
Dimensions (L x W x H)	20.00 x 16.05 x 4.40 cm (7.87 x 6.30 x 1.73 in)

VP1421

Video Input

Interfaces	2 x HDMI Type-A female (Black) 1 x VGA (HDB-15) female (Blue) 1 x HDBaseT (RJ-45) female (Silver) with selectable PoH
Max. Distance	HDMI: <ul style="list-style-type: none"> ◆ 4K@60Hz (4:4:4) up to 3m ◆ 4K@30Hz up to 10m ◆ 1080p@60Hz up to 15m VGA: <ul style="list-style-type: none"> ◆ Up to 1080p @60Hz up to 15m HDBaseT: <ul style="list-style-type: none"> ◆ 4K@30Hz (4:4:4) up to 35m (Cat 5e/6) ◆ 4K@30Hz (4:4:4) up to 40m (Cat 6a or ATEN 2L-2910 Cat 6) ◆ 1080p @60Hz up to 60m (Cat 5e/6) ◆ 1080p @60Hz up to 70m (Cat 6a or ATEN 2L-2910 Cat 6)

Video Output

Interfaces	1 x HDMI Type-A female (Black) 1 x HDBaseT (RJ-45) female (Silver) with selectable PoH
Max. Distance	HDMI: <ul style="list-style-type: none"> ◆ 4K@60Hz (4:4:4) up to 3m ◆ 4K@30Hz up to 10m ◆ 1080p@60Hz up to 15m HDBaseT: <ul style="list-style-type: none"> ◆ 4K@30Hz up to 35m (Cat 5e/6) ◆ 4K@30Hz up to 40m (Cat 6a or ATEN 2L-2910 Cat 6) ◆ 1080p @60Hz up to 60m (Cat 5e/6) ◆ 1080p @60Hz up to 70m (Cat 6a or ATEN 2L-2910 Cat 6)

Video

Max. Resolution	HDMI: Up to 4096 x 2160 / 3840 x 2160 @ 60Hz (4:4:4) VGA: Up to 1080p@60Hz HDBaseT: <ul style="list-style-type: none"> ◆ Up to 4096 x 2160 / 3840 x 2160 @60Hz (4:2:0) ◆ Up to 4096 x 2160 / 3840 x 2160 @30Hz (4:4:4)
-----------------	---

Supported Upscaling & Downscaling Resolutions	<p>Upscaling resolutions:</p> <ul style="list-style-type: none"> ◆ 1080p 60Hz to 4K 60Hz ◆ 1080p 50Hz to 4K 50Hz ◆ 1080p 24Hz to 4K 24Hz ◆ 1080p 25Hz to 4K 25Hz ◆ 1080p 30Hz to 4K 30Hz <p>Downscaling resolutions:</p> <ul style="list-style-type: none"> ◆ 4K 60Hz to 1080p 60Hz ◆ 4K 50Hz to 1080p 50Hz ◆ 4K 24Hz to 1080p 24Hz ◆ 4K 25Hz to 1080p 25Hz ◆ 4K 30Hz to 1080p 30Hz <p>Note: When videos of 4096 x 2160 in resolution are downscaled, the output will be cropped by 128 pixels in width on both the left and right.</p>
Compliance	HDMI 2.0 (3D, Deep Color, 4K); 4K HDR HDCP 2.2 compatible; Consumer Electronics Control (CEC)
Audio	
Input	<p>Stereo audio (HDMI/HDBT): 1 x mini stereo jack female (Green)</p> <p>Stereo audio (VGA): 1 x mini stereo jack female (Green)</p> <p>Microphone: 1 x 6.3mm jack connector (with selectable phantom power)</p>
Output	<p>Line Out (Unbalanced): 1 x captive screw connector, 3-pole</p> <p>Optical audio: 1 x TOSLINK (Black)</p>
Control	
RS-232	1 x captive screw connector, 3-pole
IR	1 x mini stereo jack female (Black)
Ethernet	1 x RJ-45 female (Silver)
Contact In	1 x captive screw connector, 5-pole
LED Out	1 x captive screw connector, 5-pole; LED out power: +5 VDC, 0.2 A
IR Channel	<p>HDBaseT In: 1 x mini stereo jack female (Black)</p> <p>HDBaseT Out: 1 x mini stereo jack female (Black)</p>
RS-232 Channel	<p>HDBaseT In: 1 x captive screw connector, 3-pole</p> <p>HDBaseT Out: 1 x captive screw connector, 3-pole</p>

Switches	
Power	1 x pushbutton (LED: Green/Orange), 1 x slide switch (+48 phantom power), 1 x slide switch (PoH)
Video Input Port Selection	4 x pushbuttons (LED: Green)
Video Output Port Selection	2 x pushbuttons (LED: Orange)
Selection	Mic: 1 x knob Volume: 1 x knob Mode/Unlock: 1 x pushbutton
EDID Modes	ATEN Default, Display A, Remix
Connectors	
Power	1 x DC jack (Black)
Power Consumption	DC 12V: 14.93W
Environmental	
Operating Temperature	0 - 40°C
Storage Temperature	-20 - 60°C
Humidity	0 x 80% RH, Non-Condensing
Physical Properties	
Housing	Metal
Weight	1.16 kg (2.56 lb)
Dimensions (L x W x H)	20.00 x 17.01 x 4.40 cm (7.87 x 6.70 x 1.73 in)

Limited Warranty

ATEN warrants its hardware in the country of purchase against flaws in materials and workmanship for a Warranty Period of two [2] years (warranty period may vary in certain regions/countries) commencing on the date of original purchase. This warranty period includes the LCD panel of ATEN LCD KVM switches. Select products are warranted for an additional year (see *A+ Warranty* for further details). Cables and accessories are not covered by the Standard Warranty.

What is covered by the Limited Hardware Warranty

ATEN will provide a repair service, without charge, during the Warranty Period. If a product is defective, ATEN will, at its discretion, have the option to (1) repair said product with new or repaired components, or (2) replace the entire product with an identical product or with a similar product which fulfills the same function as the defective product. Replaced products assume the warranty of the original product for the remaining period or a period of 90 days, whichever is longer. When the products or components are replaced, the replacing articles shall become customer property and the replaced articles shall become the property of ATEN.

To learn more about our warranty policies, please visit our website:
<http://www.aten.com/global/en/legal/policies/warranty-policy>