



Industrial 4G Modem

GTM-204M Series

User Manual

Version 1.3.0 March 2018



Warranty

All products manufactured by ICP DAS are under warranty regarding defective materials for a period of one year, beginning from the date of delivery to the original purchaser.

Warning

ICP DAS assumes no liability for any damage resulting from the use of this product. ICP DAS reserves the right to change this manual at any time without notice. The information furnished by ICP DAS is believed to be accurate and reliable. However, no responsibility is assumed by ICP DAS for its use, not for any infringements of patents or other rights of third parties resulting from its use.

Copyright

Copyright © 2017 by ICP DAS Co., Ltd. All rights are reserved.

Trademark

The names used for identification only may be registered trademarks of their respective companies.

Contact US

If you have any problem, please feel free to contact us. You can count on us for quick response.

Email: service@icpdas.com

Symbol description



RoHS

Manufacture of this product strictly abide by the rules of lead-free and does not contain any harmful substances.



WEEE

This symbol means this product must be collected at the time of discarding in the EU.



HOT SURFACE DO NOT TOUCH

This symbol means this product's enclosure may be with high temperature, do not touch before cooling or else will be burned.



USB

This product support USB 2.0 interface.

Table of Contents

1. Introduction	1
2. Hardware Specifications	2
3. Hardware Appearance	4
3.1 View of the GTM-204M-4G Panel	4
3.2 Pin Assignments	4
3.3 LED Indicators	5
4. Hardware Wire Connection	6
4.1 Reset Wire Connection	6
4.2 Installation	7
4.3 Quick Test	8
4.3.1 Hardware installation	8
4.3.2 Software installation (Hyper terminal)	9
5. GPRS Connection	14
5.1 XPAC-8000 (Microsoft Windows XP)	14
5.1.1 GTM-204M-4G Hardware Requirement	14
5.1.2 Create a New Modem	15
5.1.3 Create a New Dial-up and Networking Connection	21
6. USB Driver Installation	29
6.1 XPAC-8000 (Microsoft Windows XP)	29
7. Revision History	37

1. Introduction

The GTM-204M-4GE is an industrial 4G LTE and Quad-band GSM modem with RS-232 and USB interfaces that work at frequencies of FDD LTE B1/B3/B5/B7/B8/B20 and WCDMA 850/900/2100 MHz and GSM 850 MHz, EGSM 900 MHz, DCS 1800 MHz , PCS 1900 MHz. The modems utilize the 4G or 3G or GPRS network to transfer data. The features of the GTM-204M-4GE allow a variety of PLC and PC applications to take advantage of SMS and 4G or 3G or GPRS connectivity.

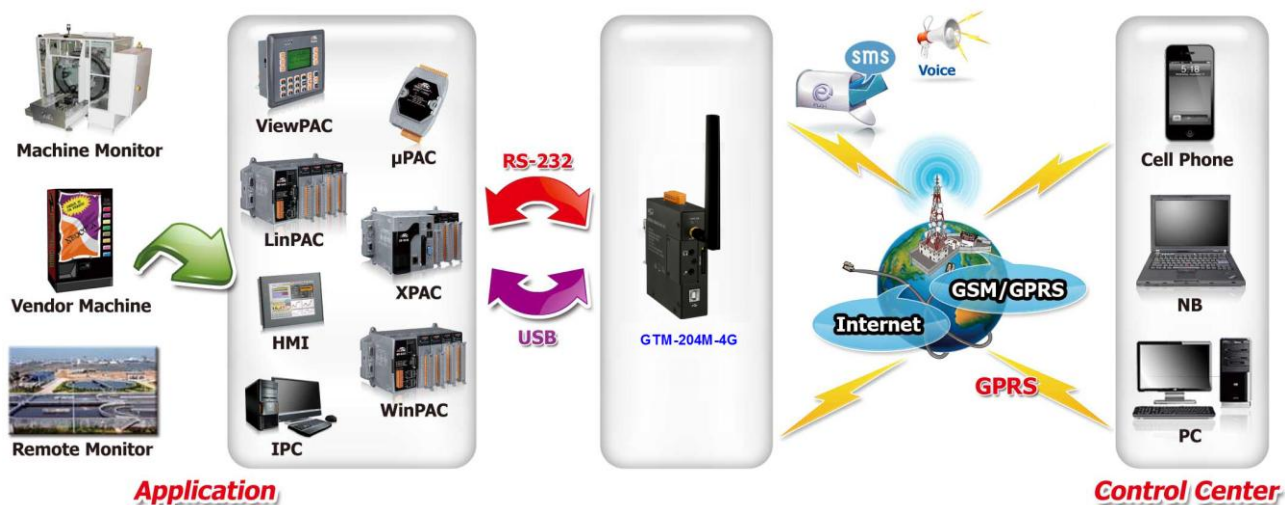

2. Hardware Specifications

Item	GTM-204M-4GE	GTM-204M-4GC
GSM System		
Frequency Band	850/900/1800/1900 MHz	900/1800MHz
GPRS Connectivity	GPRS class 12; GPRS station class B	
DATA GPRS	Downlink transfer: Max. 85.6 kbps; Uplink transfer: Max 42.8kbps	
3G System		
Frequency Band (MHz)	WCDMA 850/900/2100	WCDMA 900/2100 TD-SCDMA 1900/2100 CDMA2000 (BC0) 800
Data Transmission	DC-HSPA+ Download: Max. 42 Mbps; Upload: Max 5.76Mbps TD-SCDMA Download: Max. 4.2 Mbps; Upload: Max 2.2Mbps CDMA2000 EVDO Download: Max. 14.7 Mbps; Upload: Max 5.4Mbps	
4G System		
Frequency Band	FDD LTE: B1/B3/B5/B7/B8/B20	FDD LTE: B1/B3/B8 TDD LTE: B38/B39/B40/B41
Data Transmission	Download Max 100Mbps / Upload Max 50Mbps	
SMS		
SMS	MT, MO, CB, Text, and PDU mode	
Comm. Interface		
COM Port	RxD, TxD, GND	
COM Port Baud Rate	9600 bps ~ 115200 bps (default : 115200 bps)	
USB	USB 2.0 (high speed)	
USB Driver Support	Windows XP/7/8/10, Windows Server 2012	
LED Indicators		
Power	Red	
3G/GSM	Green	
Power		
Protection	Power reverse polarity protection	
Frame Ground Protection	ESD, Surge, EFT, Hi-Pot	
Required Supply Voltage	+10 V _{DC} ~ +30 V _{DC}	
Rated Current	30 ~ 15 mA / 10 ~ 30 V _{DC}	
Reset Input		
Input Type	Isolated, 3750 V _{rms}	
On Voltage Level	+3.5 V _{DC} ~ +30V _{DC}	
Off Voltage Level	+1 V _{DC} max.	
Input Impedance	3 k Ω , 0.25W	
Mechanical		

Casing	Metal
Dimensions (W x L x H)	28 mm x 78.5 mm x 100 mm
Installation	DIN-Rail
Environment	
Operation Temperature	-25°C to 70°C
Storage Temperature	-40°C to 80°C
Humidity	5~90% RH, non-condensing

3. Hardware Appearance

3.1 View of the GTM-204M-4G Panel

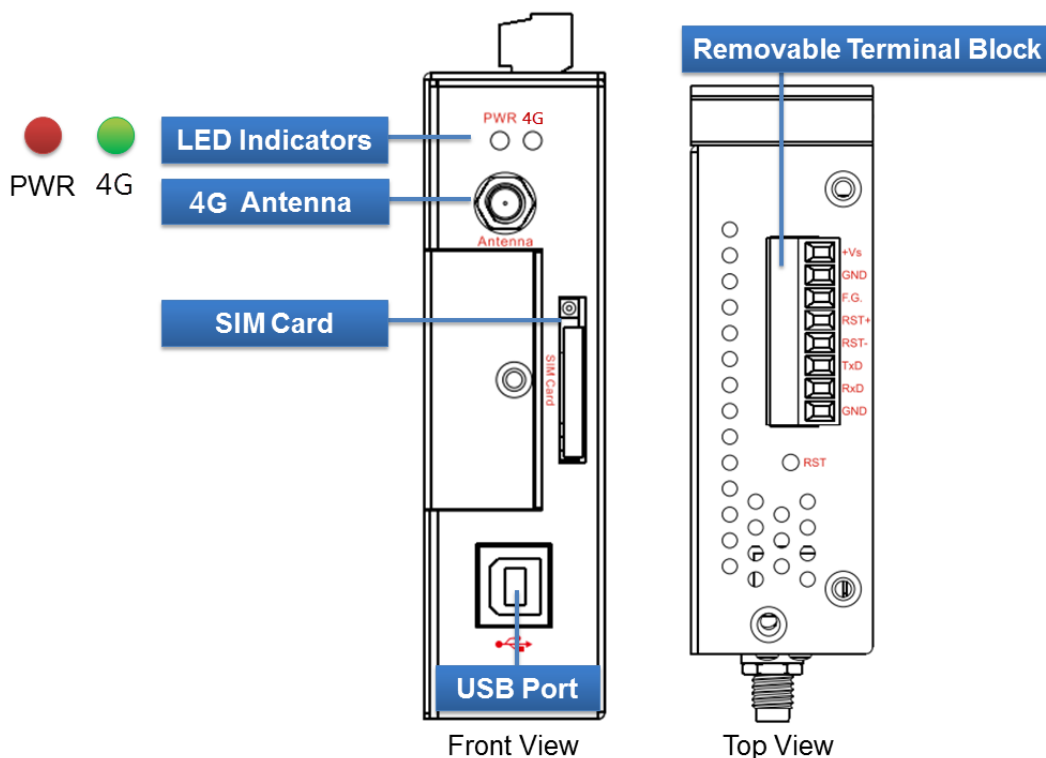

3.2 Pin Assignments

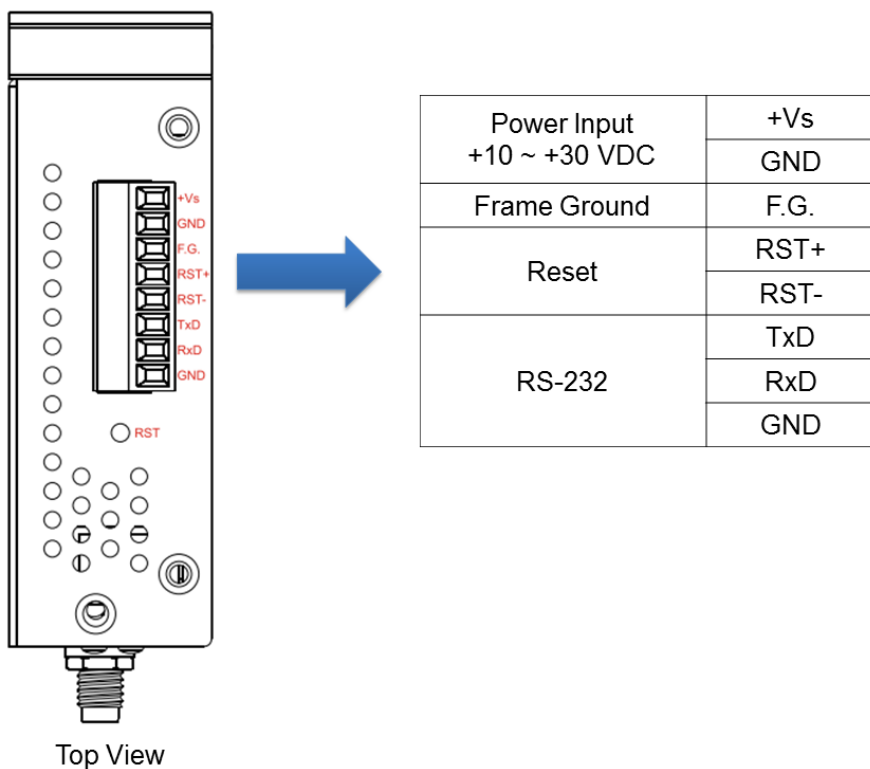

3.3 LED Indicators

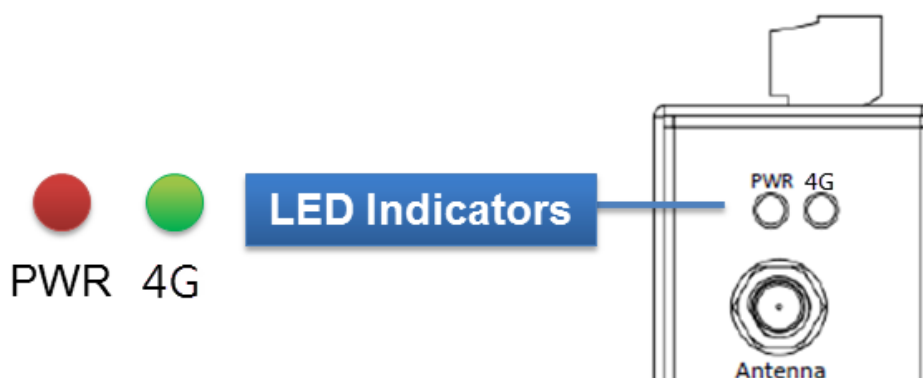

There are two LED indicators to help users to judge the various conditions of GTM-204M-4G. The description is as follows :

A. PWR(Red) : The PWR LED can indicate the status of Power module.

Power normal	Power fail
Always ON	Always OFF

B. 4G (Green) : The modem LED can indicate the status of GSM module.

4G module normal	4G module fail	Data transmission
ON 2 sec and OFF 1 sec	OFF or ON 1 sec and OFF 2 sec	Blinking per 0.2 sec

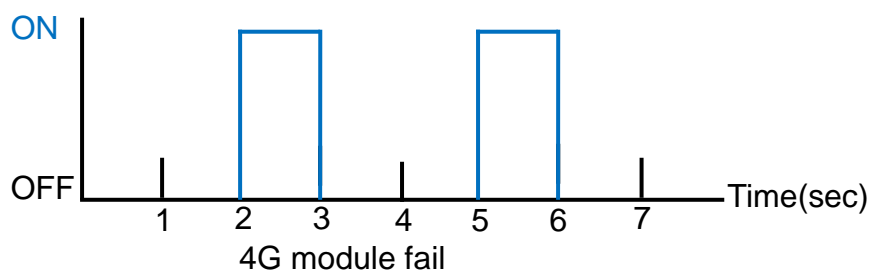
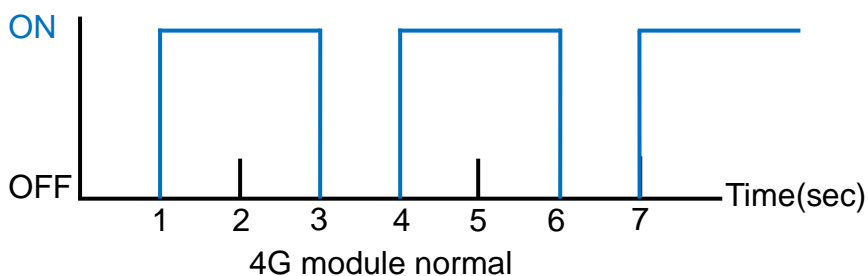

4. Hardware Wire Connection

4.1 Reset Wire Connection

Input Type	Reset State ON	Reset State OFF
Reset Input		

Reset Input	
ON Voltage Level	+3.5 V _{DC} ~ +30 V _{DC}
OFF Voltage Level	+1 V _{DC} max.

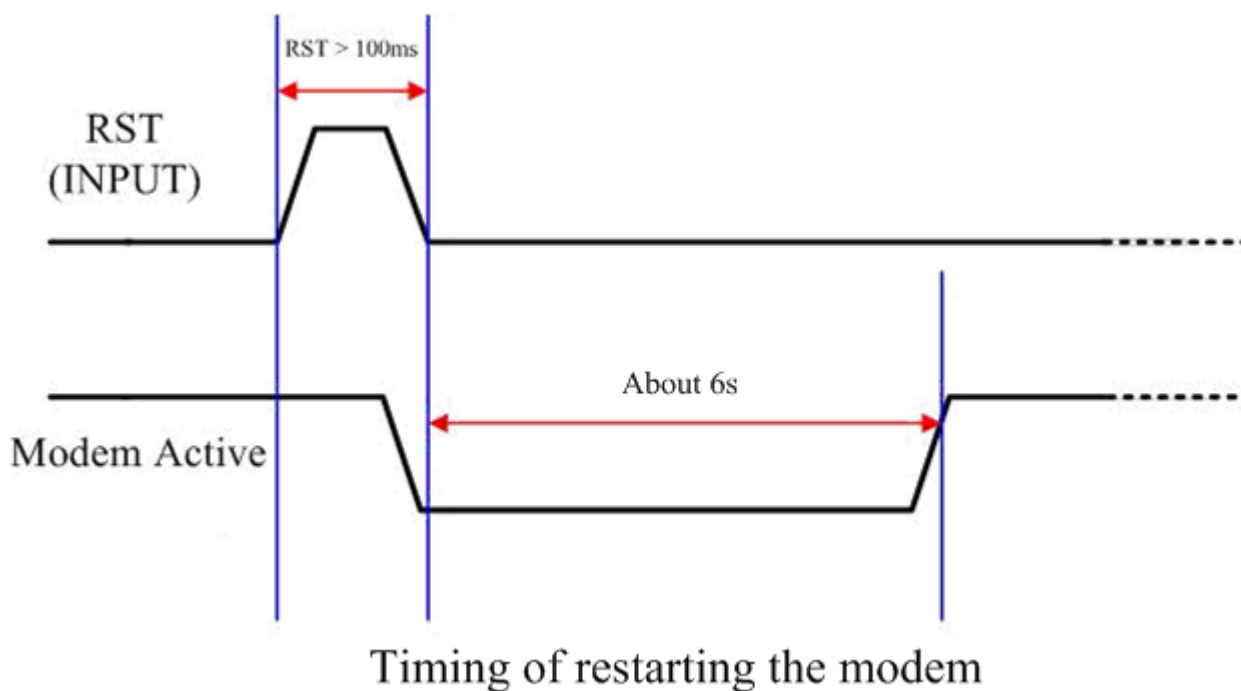

4.2 Installation

GTM-204M-4G should be installed by technical person who should be with the proper authorization.

GTM-204M-4G should install on the location that general person will not be touch.

- SIM card and 4G antenna installation



WARNING! HOT SURFACE DO NOT TOUCH



The product's enclosure may be with high temperature, do not touch before cooling or else will be burned.

SAFETY INSTRUCTION NOTES



The unit installation to final system and the DC source (SELV, Limited Power Source) that is intended to connect with power input pins (DC.+VS / DC.GND) should be complied with requirements of EN 60950-1. Be sure before connect to input pins.

4.3 Quick Test

4.3.1 Hardware installation

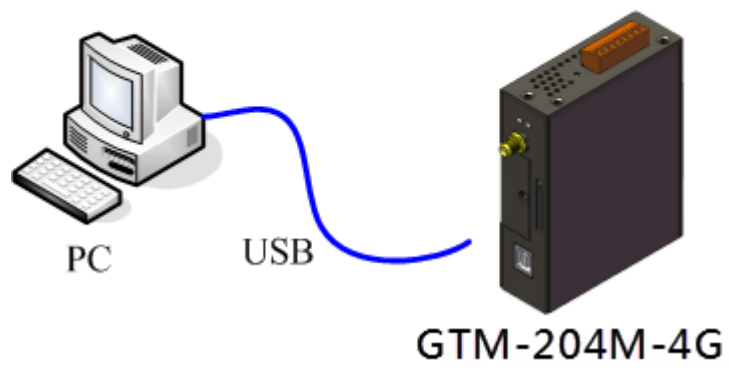

4.3.2 Software installation (Hyper terminal)

Step 1 : Start → All Programs → Accessories → Communications → Hyper Terminal

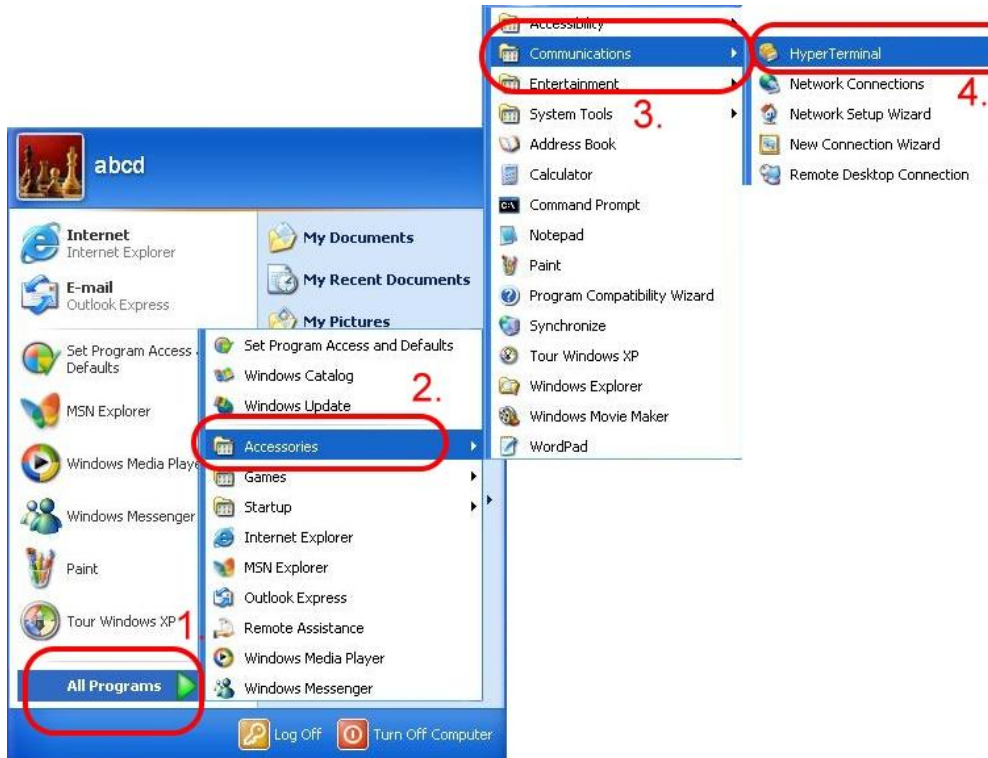

Step 2 : If there is a pop-up form that says “Default Telnet Program?”, please select “Yes”

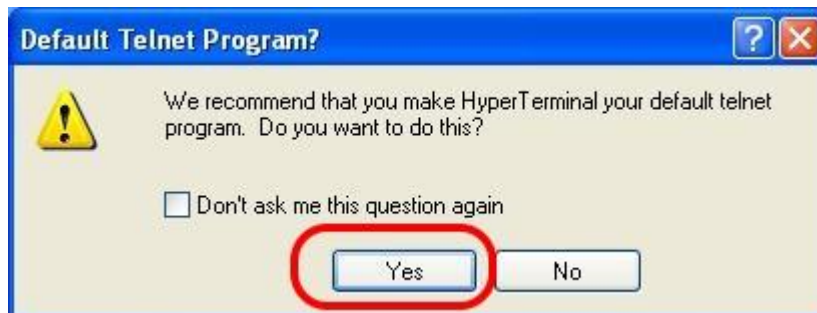

Step 3 : Input new connection name → Click “OK”

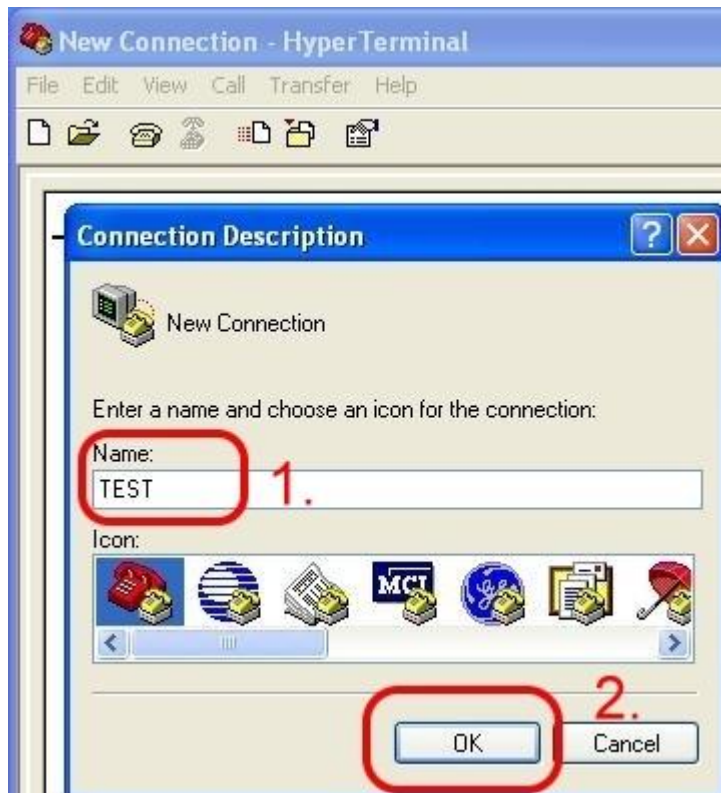

Step 4 : Select your PC serial port → Click “OK”



Step 5 : Please refer to the following settings

Bits per second	115200
Data bits	8
Parity	None
Stop bits	1
Flow control	None

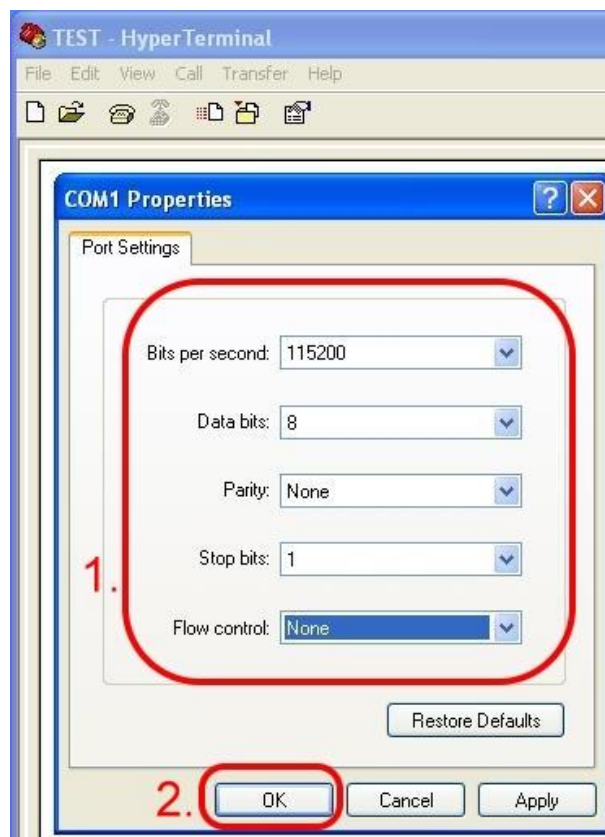

Step 6 : File → Properties

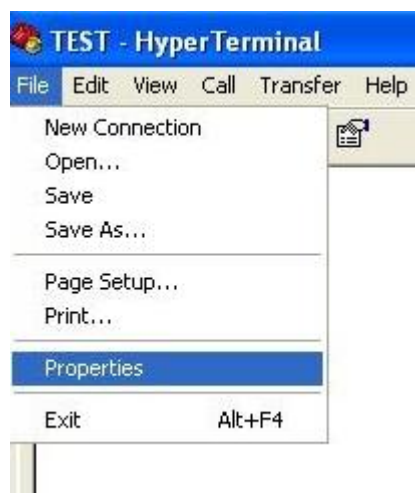

Step 7 : Settings → Click “ASCII Setup...”

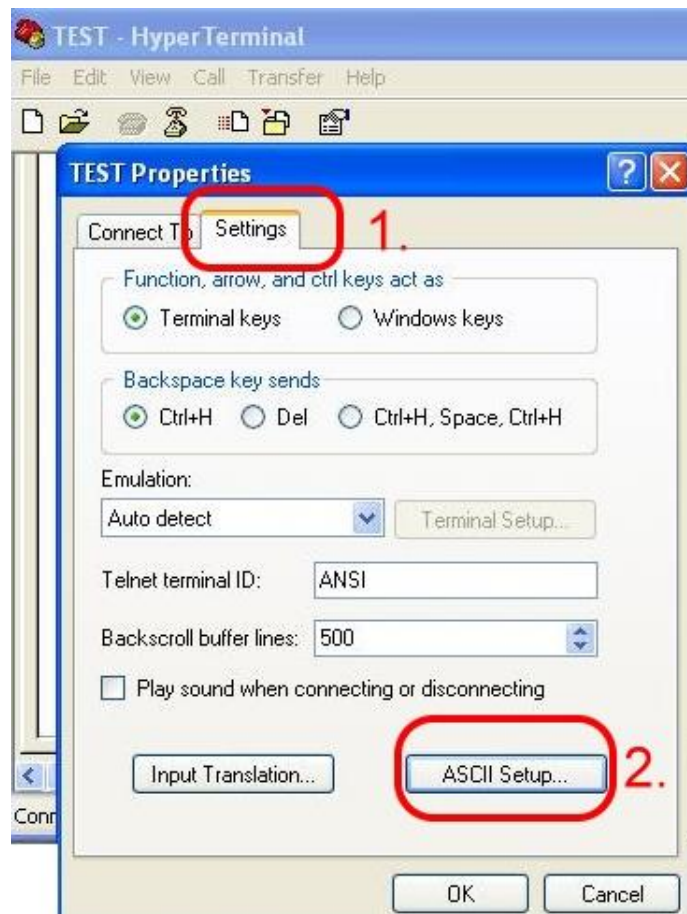

Step 8 : Select “Echo typed characters locally” → Click “OK”

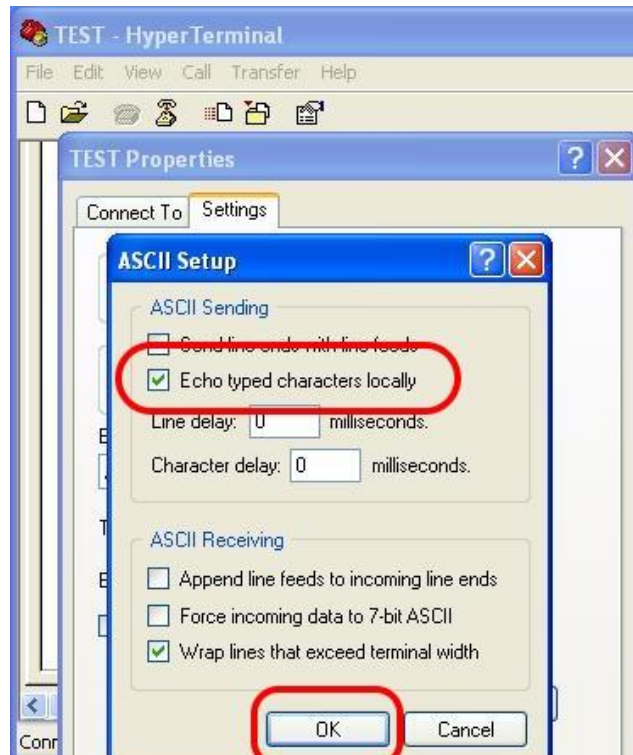

Step 9 : Input “AT” and press “Enter” , then you will receive “AT OK”



5. GPRS Connection

5.1 XPAC-8000 (Microsoft Windows XP)

5.1.1 GTM-204M-4G Hardware Requirement

- A. GTM-204M-4G (Please install USB driver first)
- B. XPAC-8000
- C. USB cable



5.1.2 Create a New Modem

Step 1 : Control Panel → Double-click “Phone and Modem Options”

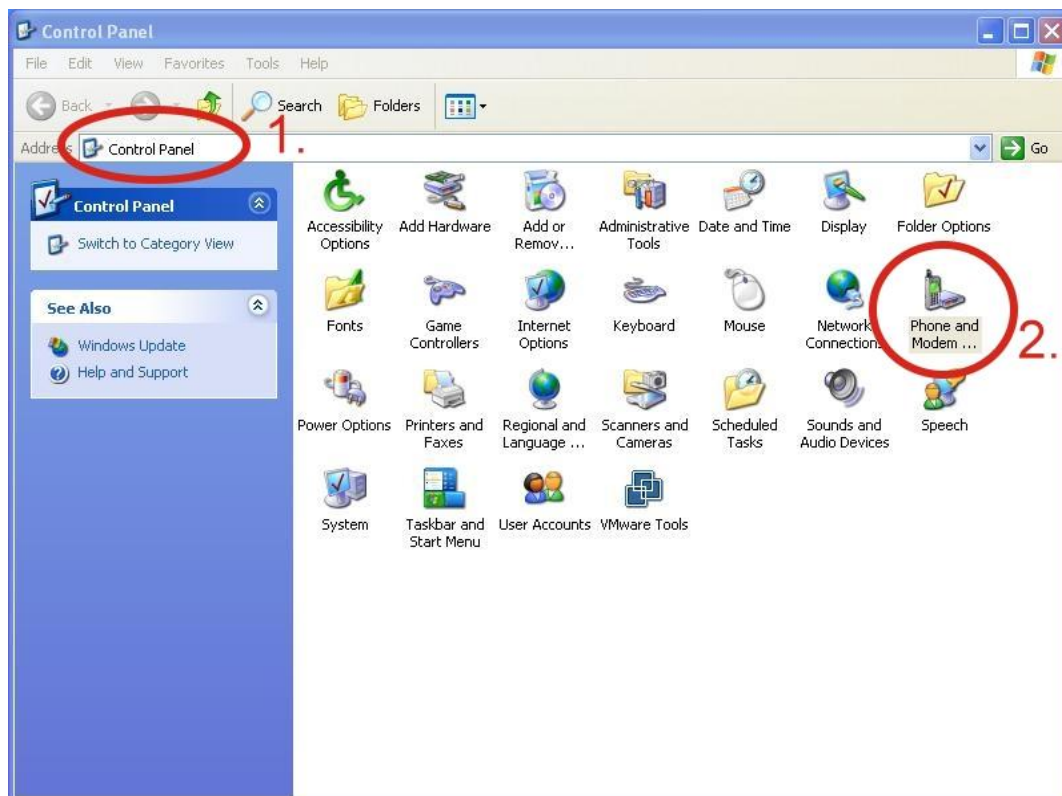

Step 2 : Set the area code for the first time → Click “OK”

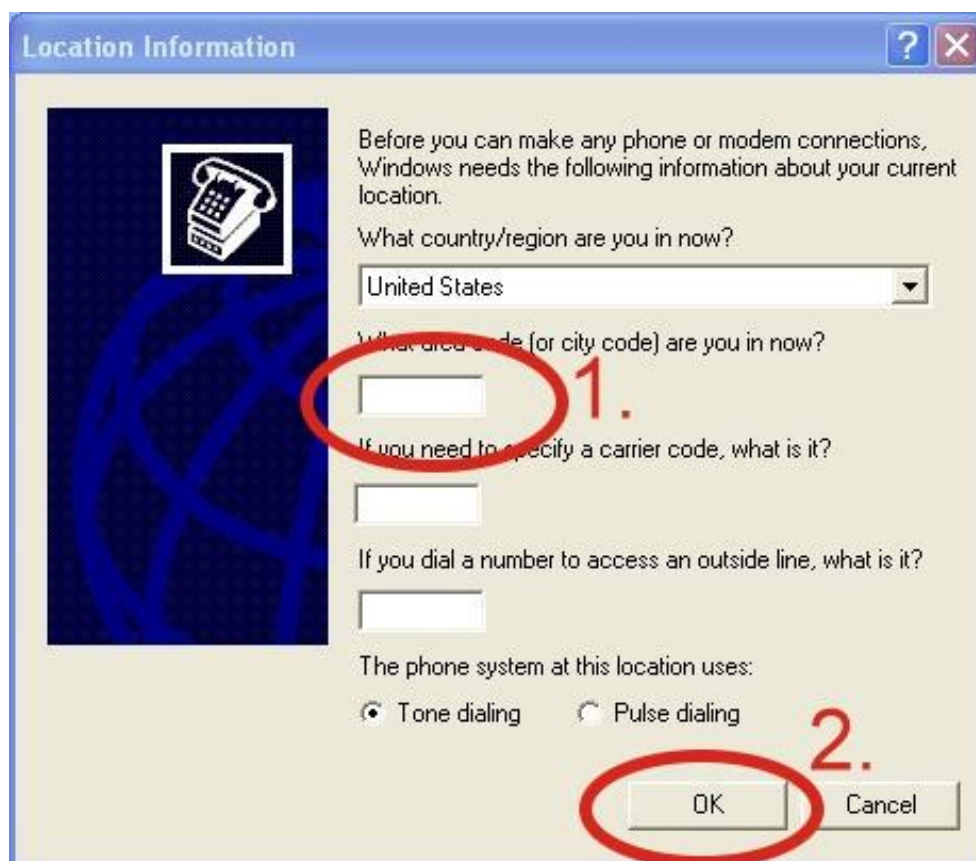

Step 3 : Control Panel → Double-click “Phone and Modem Options” → Modem → Click “Add”



Step 4 : Select “Don't detect my modem; I will select it from a list.” → Click “Next”



Step 5 : Select “Standard Modem Types” → Select “Standard 19200 bps Modem”
→ Click “Next”

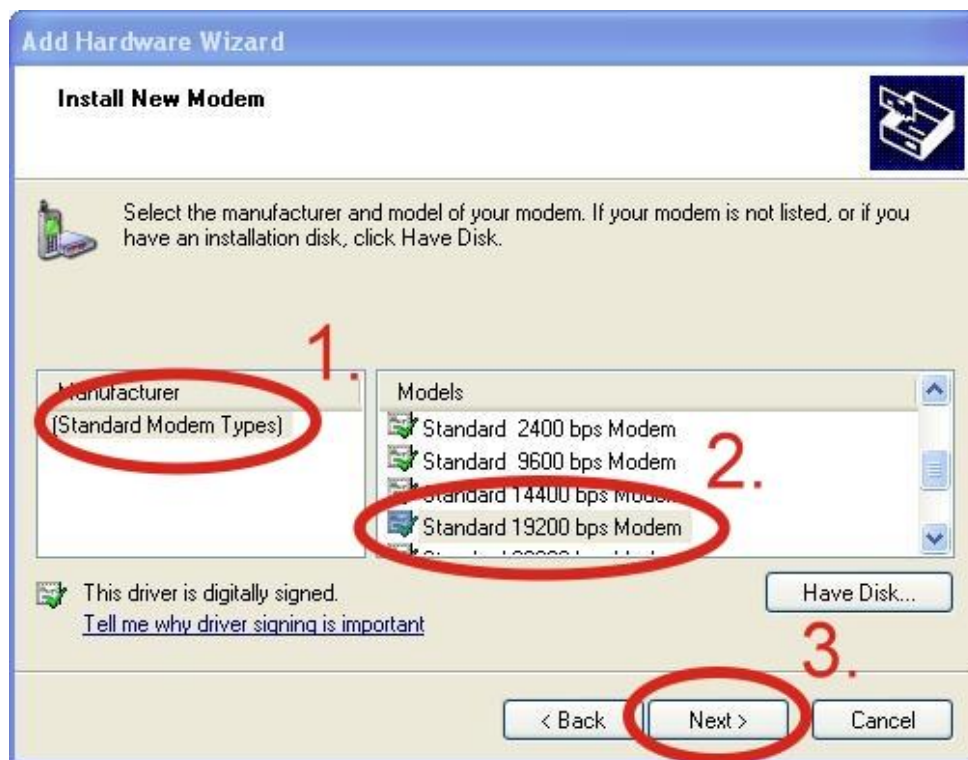

Step 6 : Select your COM Port to connect to the modem → Click “Next”



Step 7 : Click “Finish” to finish the install new modem.



Step 8 : Control Panel → Double-click “Phone and Modem Options” → Modem → Select “Standard 19200 bps Modem” → Click “Properties”

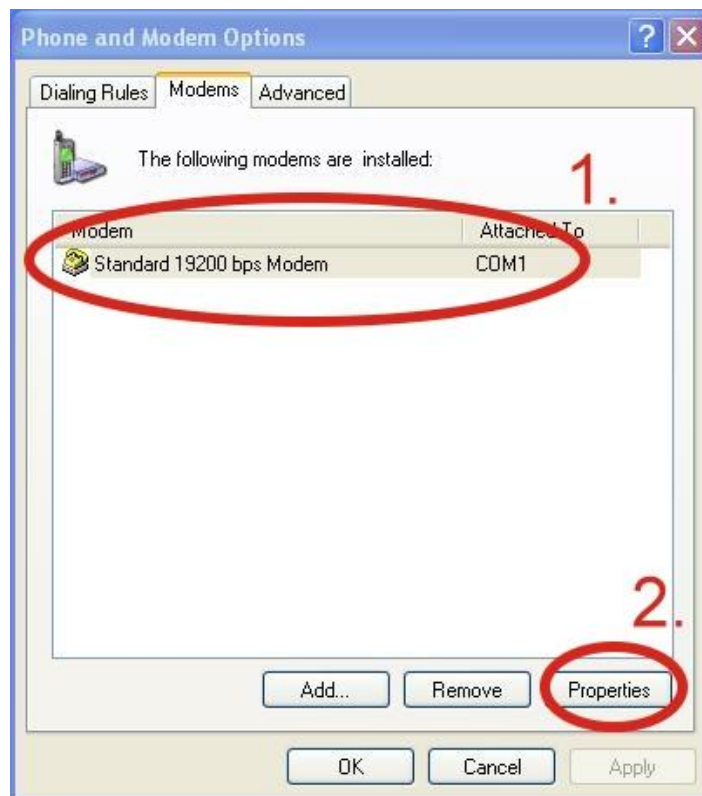

Step 9 : Modem → Maximum Port Speed → 115200

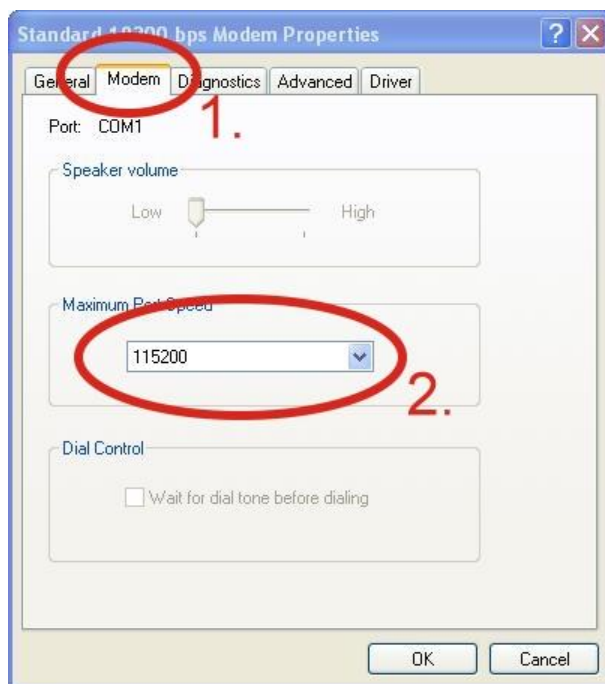

Step 10 : Advanced → Extra initialization commands

Note : GPRS's APN must be provided from your Telecom. CO., LTD.

For example in Taiwan: AT+CGDCONT=1,"IP","INTERNET"

For example in China: AT+CGDCONT=1,"IP","CMNET"

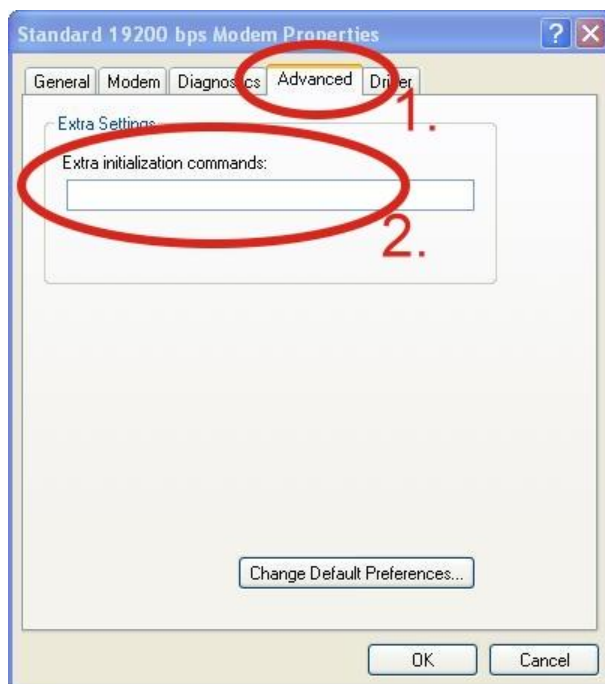

Step 11 : Diagnostics → Query Modem → Click “OK”

Note : If user queries modem that gets an Error, Please try again.

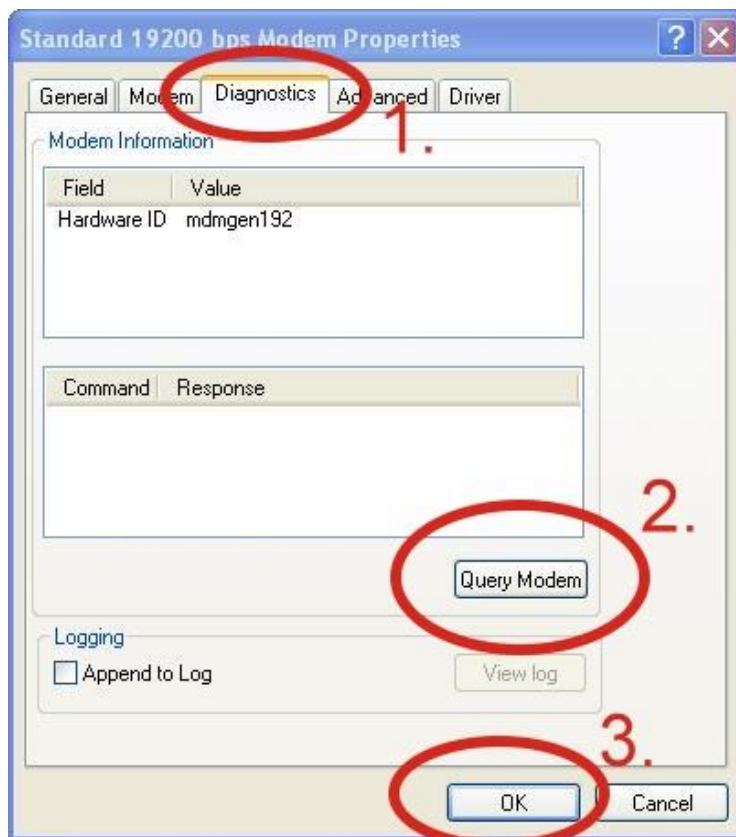

Step 12 : Click “OK”

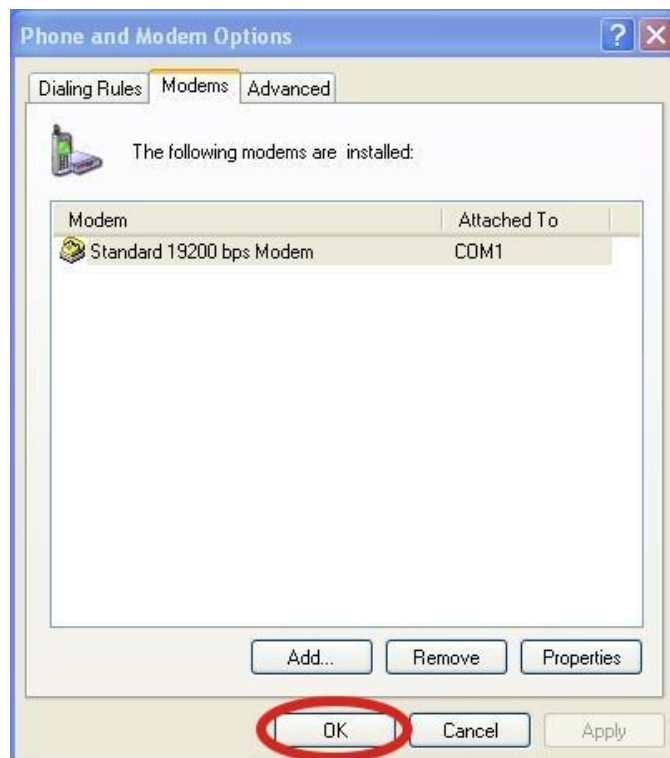

5.1.3 Create a New Dial-up and Networking Connection

Step 1 : Control Panel → Network Connections → Click “Create a new connection”

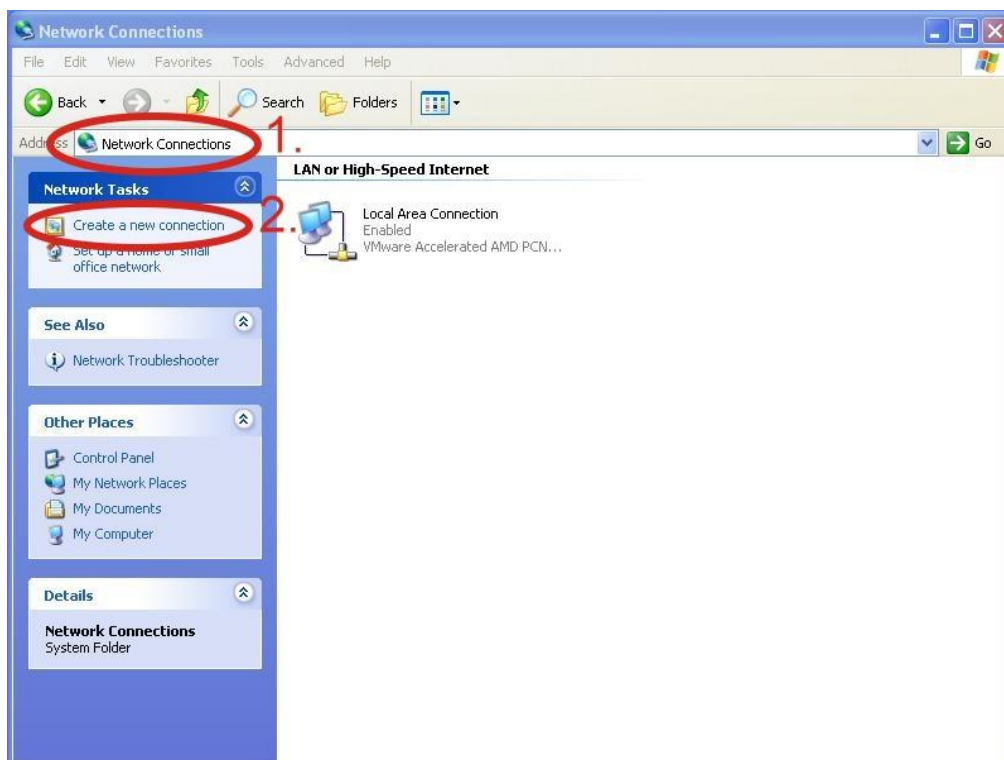

Step 2 : Click “Next”



Step 3 : Select “Connect to the Internet” → Click “Next”

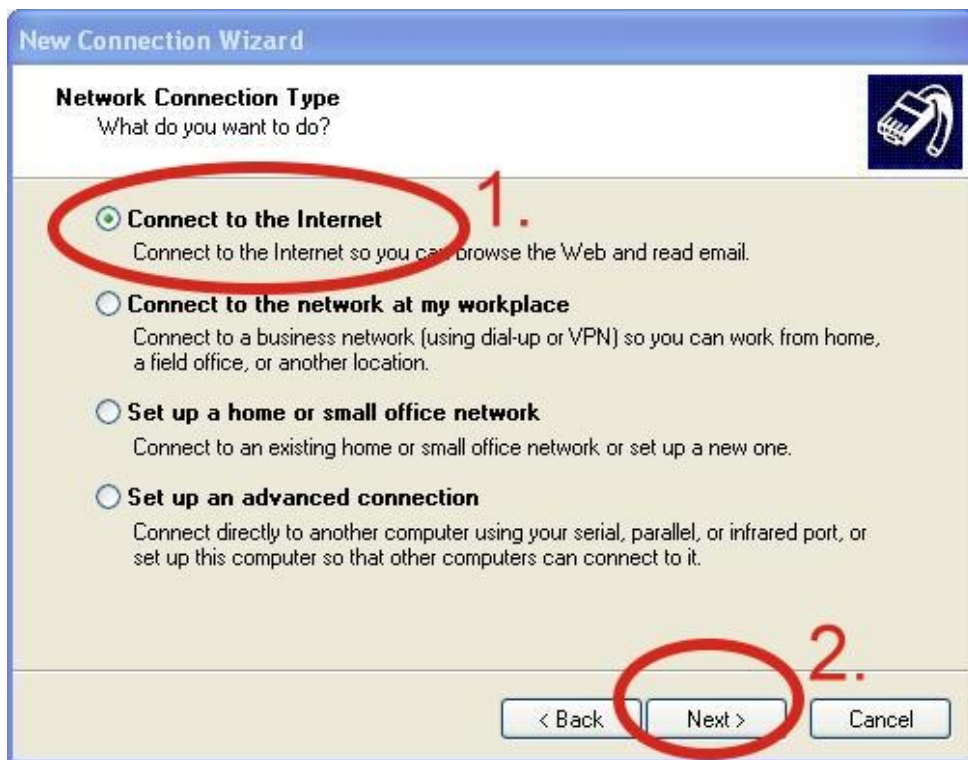

Step 4 : Select “Connect using a dial-up modem” → Click “Next”

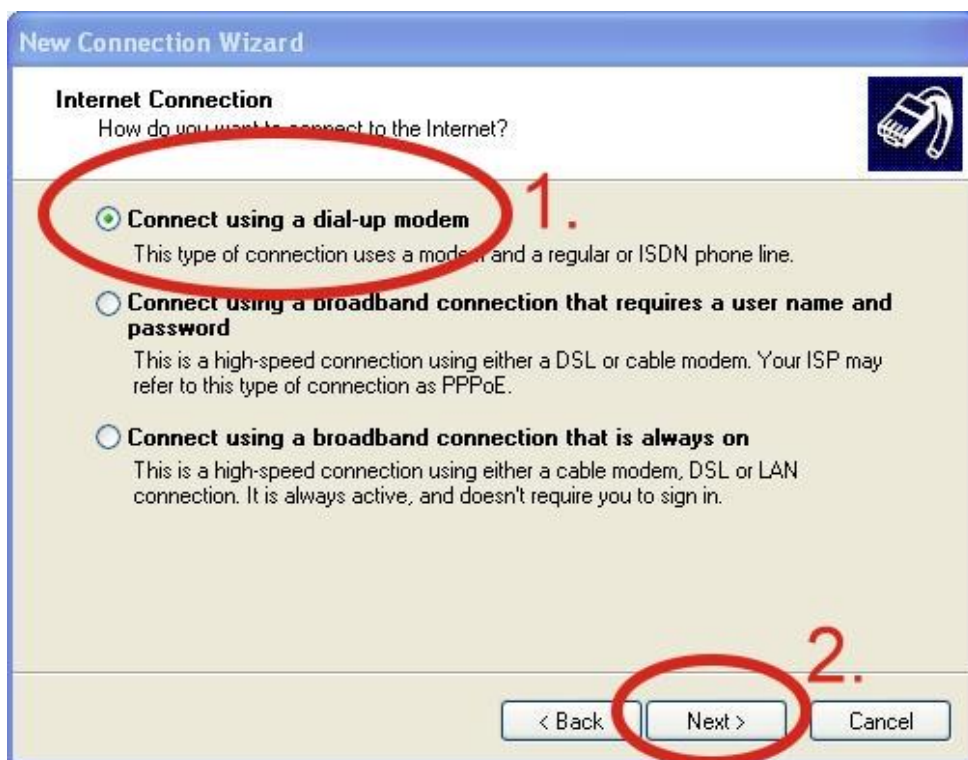

Step 5 : ISP Name → Your GPRS 's name → Click "Next"

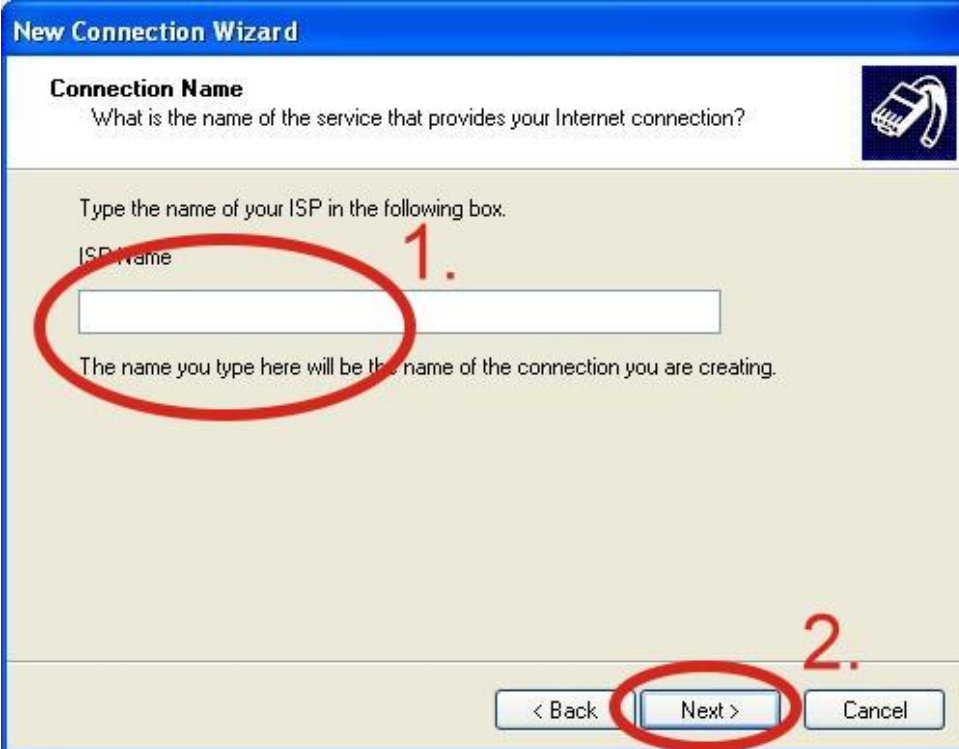

New Connection Wizard

Connection Name
What is the name of the service that provides your Internet connection?

Type the name of your ISP in the following box.

ISP Name **1.**

The name you type here will be the name of the connection you are creating.

< Back **Next >** Cancel **2.**

Step 6 : Phone Number: → Click "Next"

Note : Phone Number must be provided from your Telecom. CO., LTD.

For example in Taiwan: *99***1#



New Connection Wizard

Phone Number to Dial
What is your ISP's phone number?

Type the phone number to dial.

Phone number: **1.**

You might need to include a "+" or the area code, or both. If you are not sure you need the extra numbers, dial the phone number on your telephone. If you hear a modem sound, the number dialed is correct.

< Back **Next >** Cancel **2.**

Step 7 : GPRS 's User name and GPRS 's Password → Click “Next”

Note : GPRS's User name and GPRS's Password must be provided from your Telecom. CO., LTD.



New Connection Wizard

Internet Account Information
You will need an account name and password to sign in to your Internet account.

Type an ISP account name and password, then write down this information and store it in a safe place. (If you have forgotten an existing account name or password, contact your ISP.)

User name:

Password:

Confirm password:

Use this account name and password when anyone connects to the Internet from this computer.

Make this the default Internet connection.

Turn on Internet Connection Firewall for this connection.

< Back **Next >** Cancel

Step 8 : Click “Finish”



New Connection Wizard

Completing the New Connection Wizard

You have successfully completed the steps needed to create the following connection:

Dial-up Connection

- Make this the default connection
- This connection is firewalled
- Share with all users of this computer
- Use the same user name & password for everyone

The connection will be saved in the Network Connections folder.

Add a shortcut to this connection to my desktop.

To create the connection and close this wizard, click Finish.

< Back **Finish** Cancel

Step 9 : Control Panel → Network Connections → Click “Your GPRS ‘s name” → File → Properties

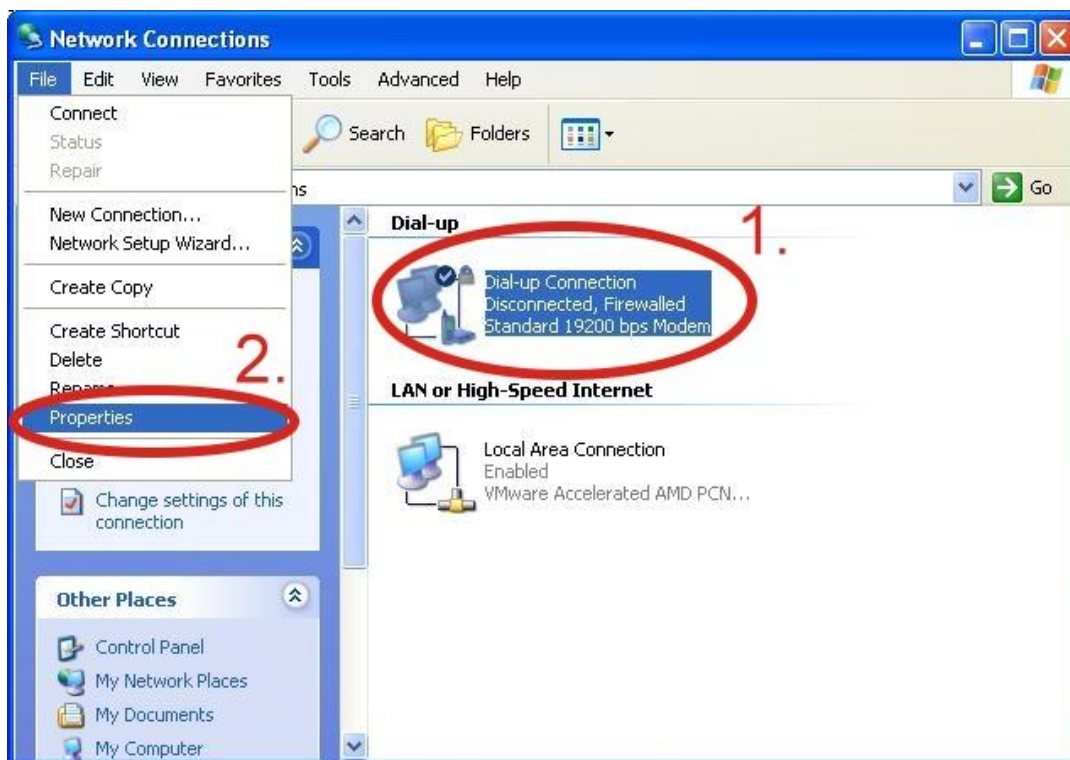

Step 10 : General → Select “Standard 19200 bps Modem” → Click “Configure”



Step 11 : Maximum speed(bps) → Select “115200” →
disable “Enable hardware flow control” (Note) → Click “OK”

Note : Please don't select “Enable hardware flow control”

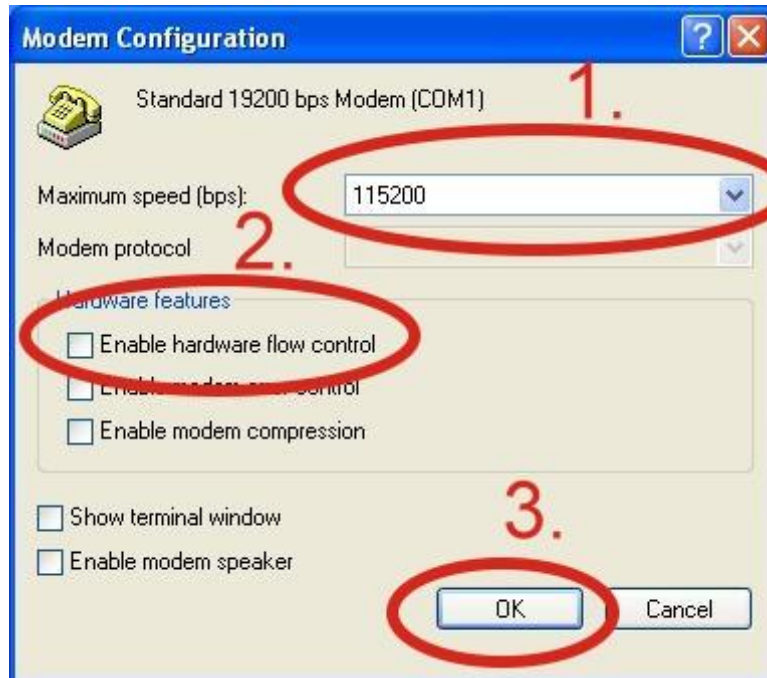

Step 12 : Click “OK”



Step 13 : Control Panel → Network Connections → Double-Click “Your GPRS ‘s name”

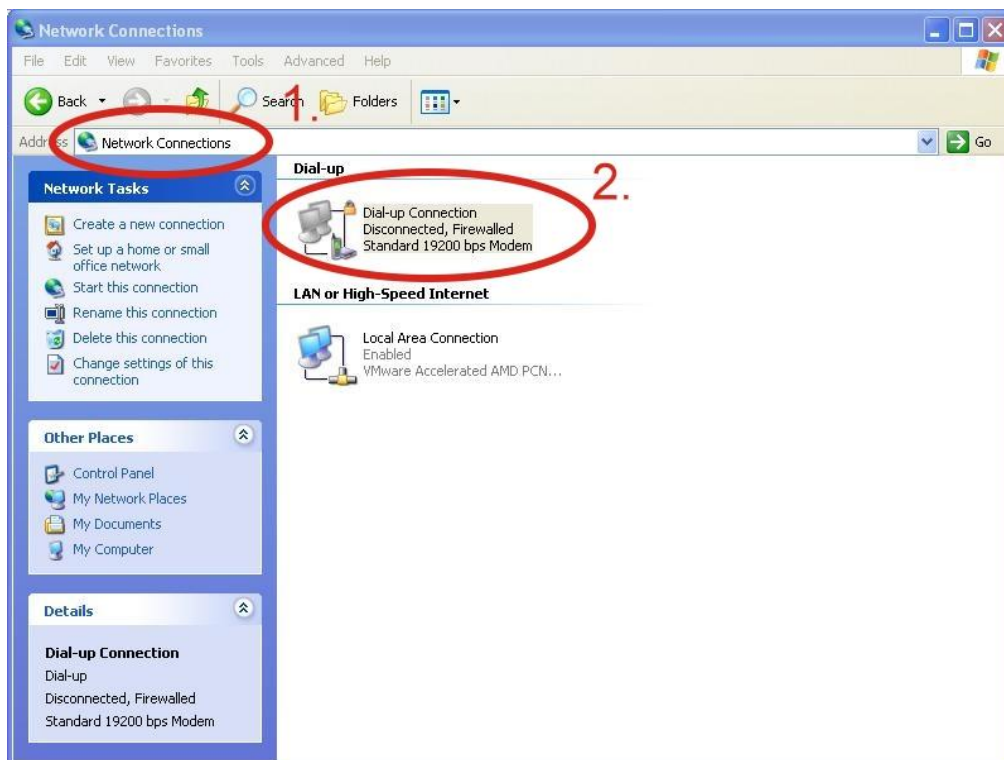

Step 14 : Click “Dial”



Step 15 : If you connect to internet successfully, your toolbar has new logo



Step 16 : You can Double-Click the new logo → Click “Details” → Get your IP address

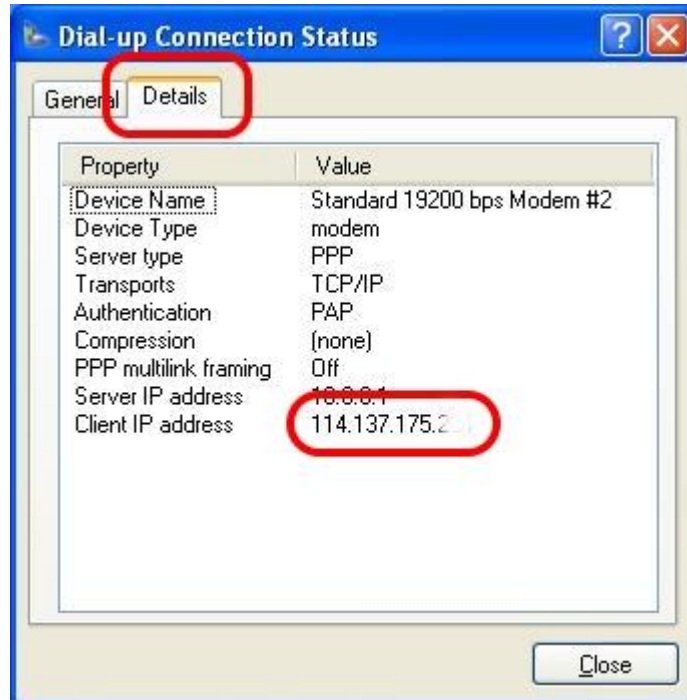

6. USB Driver Installation

6.1 XPAC-8000 (Microsoft Windows XP)

Step 1 : Double Click "GTM-204M-4G USB driver V1.00.exe" to install the driver.

Step 2 : Click "Next".

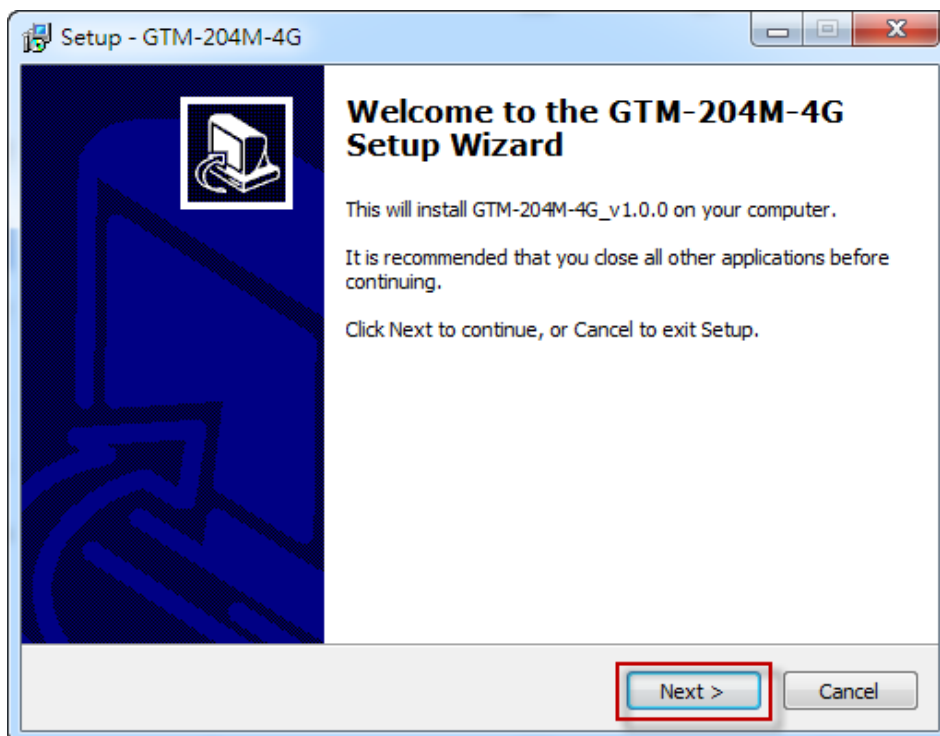

Step 3 : Click "Next"

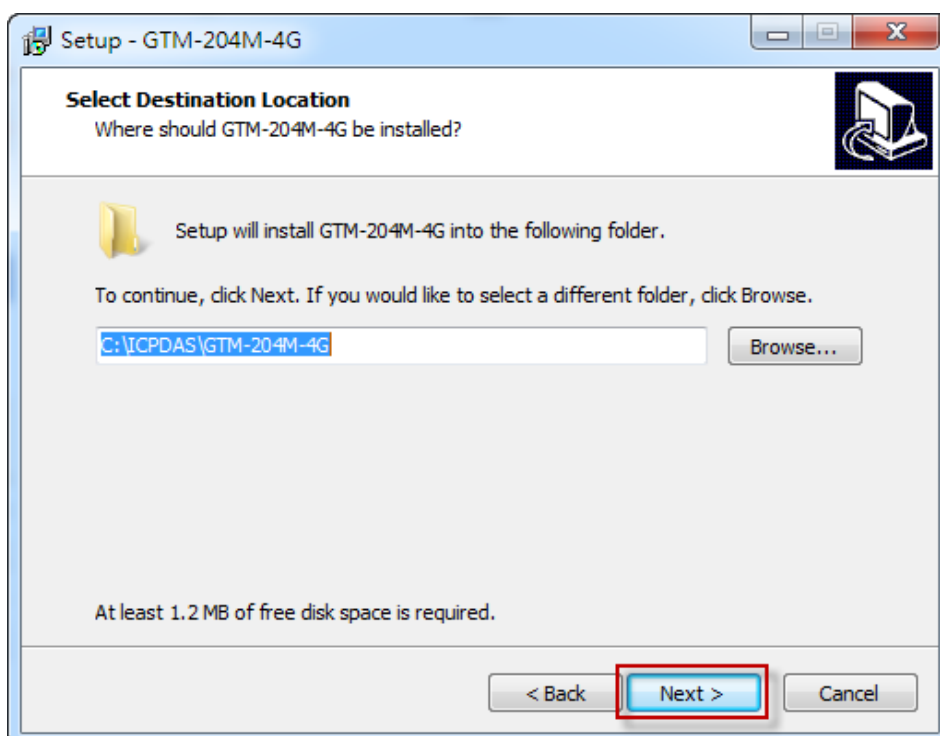

Step 4 : Select "Install"

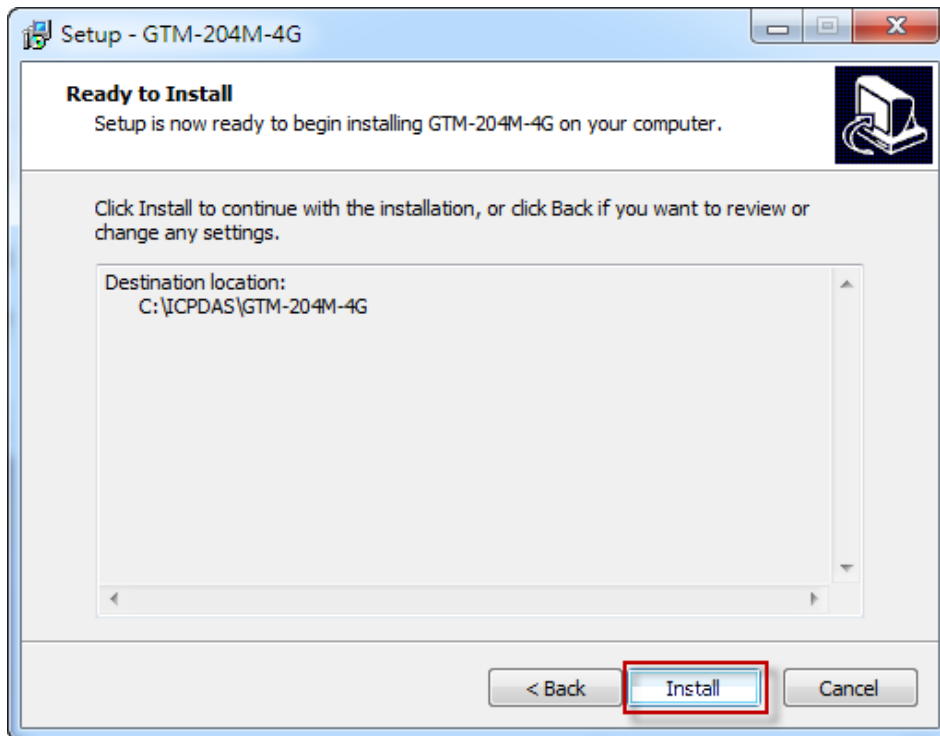

Step 5 : Click "Finish"

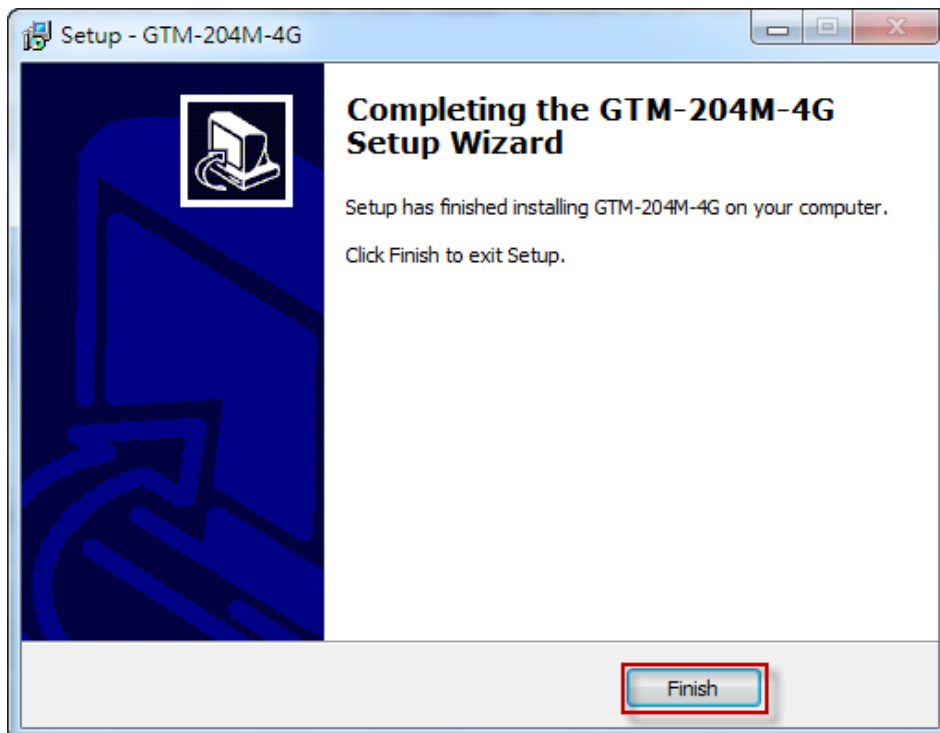

Step 6 : Connect the USB of GTM-204M-4G with the PC

Step 7 : The “Found New Hardware Wizard” window for “Quectel LTE Module” will pop-out.

Please click “Next”.

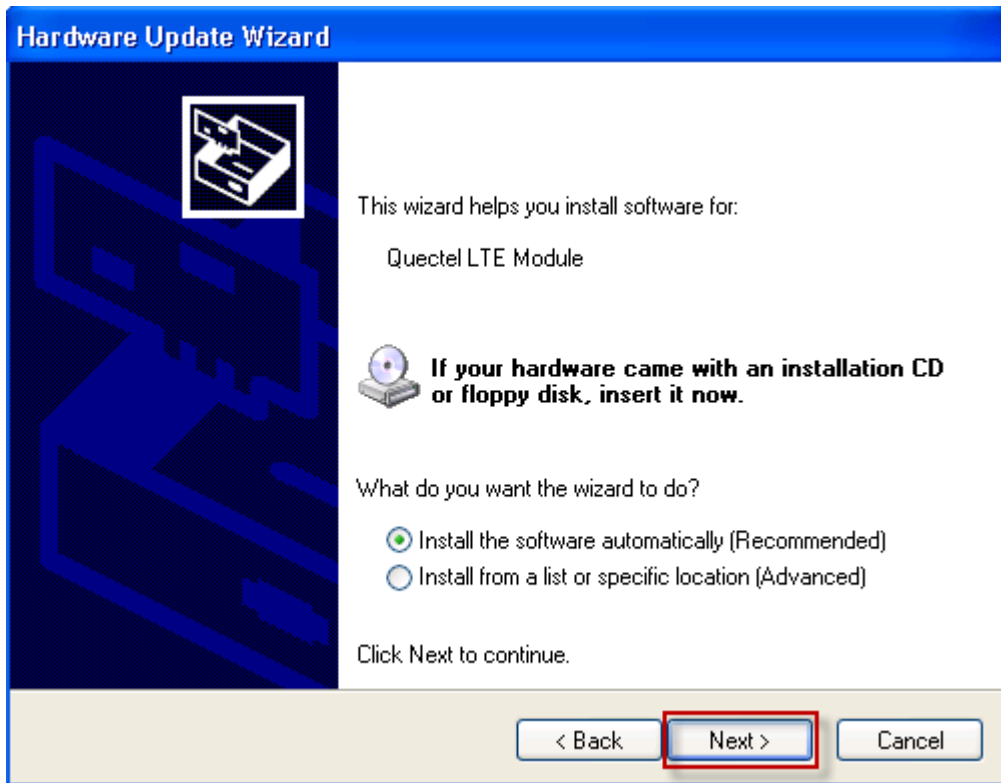

Step 7-1 : Click "Continue Anyway".



Step 7-2 : Click "Finish" if you got a success message.

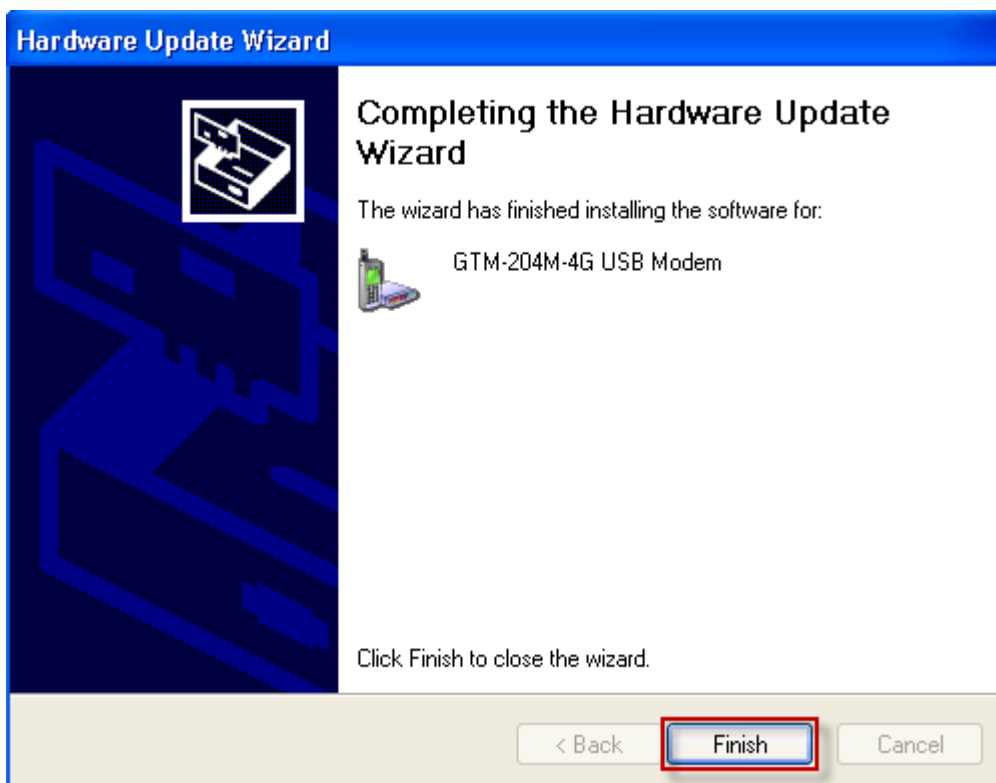

Step 7-3 : Click “Back” if you got a fail message, and then choose “Install from a list or specific location” in all install steps.

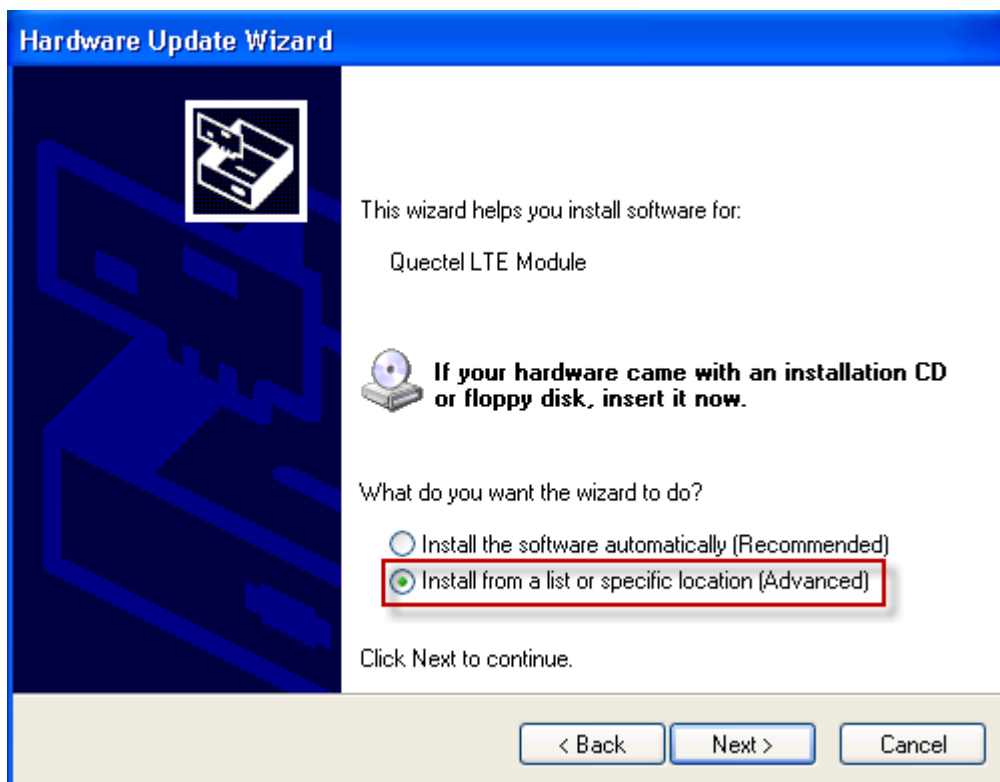

Step 7-4 : Click “Browse” to choose your installing folder, and Click “Next”.

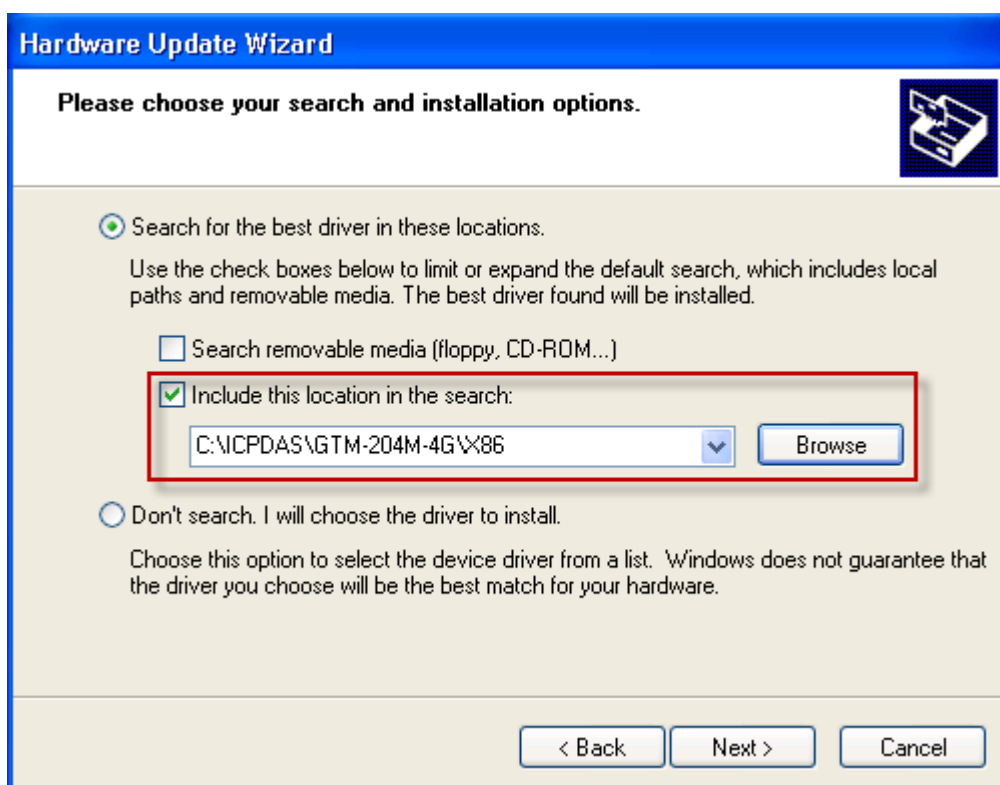

Step 8 : The “Hardware Installation” window for “GTM-204M-4G Wireless Ethernet Adapter” will pop-out. Please click “Continue Anyway”.



Step 9 : The “Hardware Installation” window for “GTM-204M-4G USB AT Port” will pop-out. Please click “Continue Anyway”.



Step 10 : The “Hardware Installation” window for “GTM-204M-4G USB NMEA Port” will pop-out. Please click “Continue Anyway”.



Step 11 : The “Hardware Installation” window for “GTM-204M-4G USB DM Port” will pop-out. Please click “Continue Anyway”.



Step 12 : Finish the all install steps. Please open “Device manager”, and you will found new 8 items in your computer.

The “GTM-204M-4G USB Modem” is a Modem for dial-up to 4G/3G/GPRS Network.

The “GTM-204M-4G USB AT Port” is an “AT command port” for GSM library.

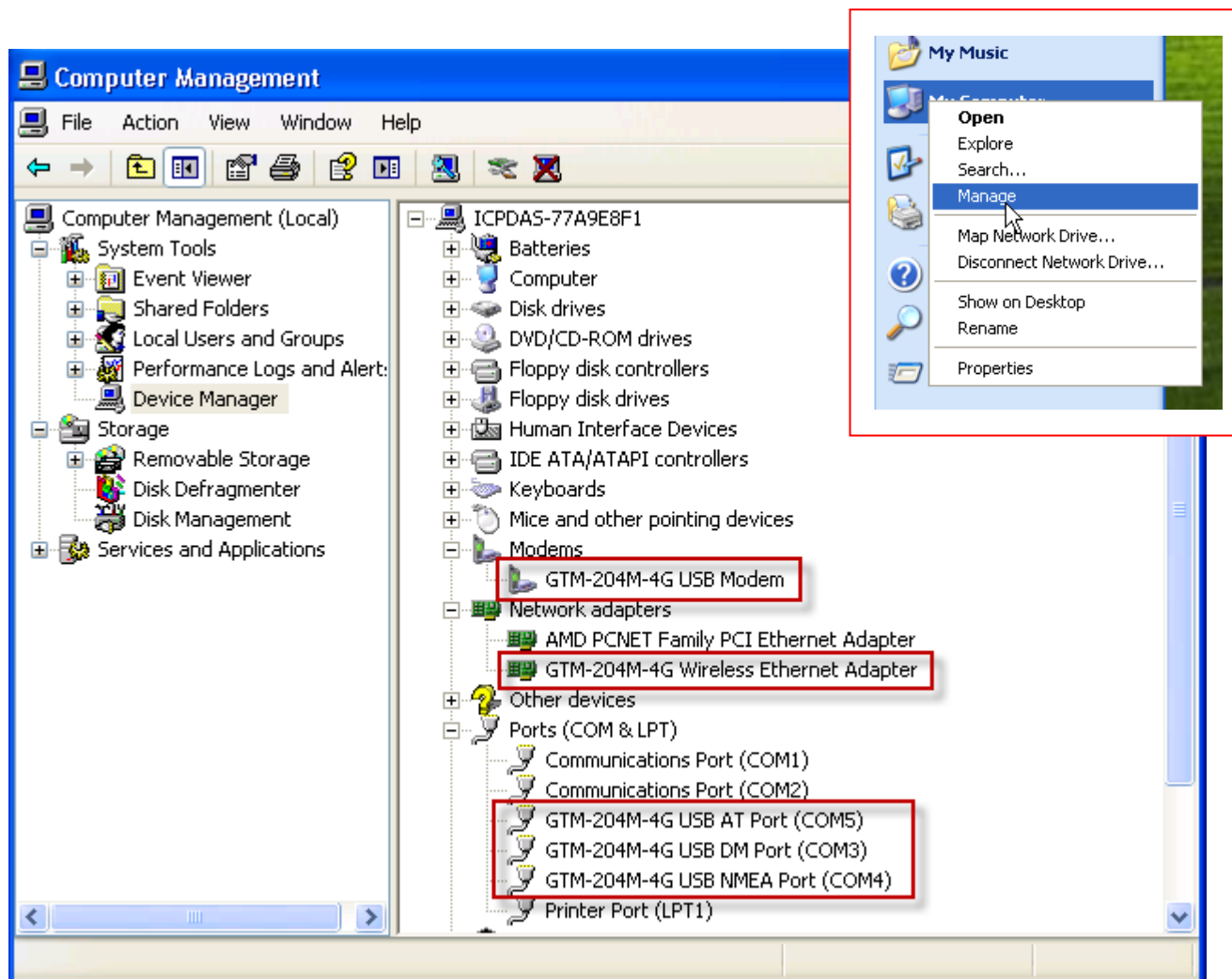

7. Revision History

Revision	Date	Author	Description
1.0	2016/06/14	Eddie	First Release
1.1	2016/09/09	Eddie	Modify Hardware Specifications
1.2	2017/08/15	Eddie	Update Hardware Specifications
1.3	2017/09/05	Eddie	Update Hardware Specifications