

# GW-7662 User Manual

Version 1.01, July. 2020

## **Warranty**

---

All products manufactured by ICP DAS are under warranty regarding defective materials for a period of one year, beginning from the date of delivery to the original purchaser.

## **Warning**

---

ICP DAS assumes no liability for any damage resulting from the use of this product. ICP DAS reserves the right to change this manual at any time without notice. The information furnished by ICP DAS is believed to be accurate and reliable. However, no responsibility is assumed by ICP DAS for its use, not for any infringements of patents or other rights of third parties resulting from its use.

## **Copyright**

---

Copyright © 2015 by ICP DAS Co., Ltd. All rights are reserved.

## **Trademark**

---

The names used for identification only may be registered trademarks of their respective companies.

## **Contact US**

If you have any problem, please feel free to contact us.  
You can count on us for quick response.

Email: [service@icpdas.com](mailto:service@icpdas.com)

# Table of Contents

---

<b>Table of Contents .....</b>	<b>3</b>
<b>1. Introduction .....</b>	<b>5</b>
1.1. Features .....	6
1.2. Specification .....	7
1.3. Internal I/O Structure .....	9
1.4. Pin Assignment.....	10
1.5. Overview .....	12
1.6. Wiring and Jumper Setting Instructions .....	16
1.6.1. RS-232 Connection .....	16
1.6.2. RS-422 Connection .....	17
1.6.3. RS-485 Connection .....	18
1.7. Dimensions.....	20
<b>2. PROFINET .....</b>	<b>21</b>
2.1. Device classes of PROFINET IO.....	21
2.2. Device Description.....	22
2.3. Conformance Classes (CC).....	23
<b>3. Basic Application .....</b>	<b>25</b>
3.1. Connect to Network, PC and PROFINET IO controller.....	25
3.2. Network configuration.....	26
3.3. GSD Import .....	34
3.4. Project Setup.....	36
<b>4. Communication .....</b>	<b>44</b>
4.1. Communication Sequence .....	44

4.2. Module configuration .....	49
4.3. PROFINET Input Data Area.....	50
4.4. PROFINET Output Data Area.....	51
4.5. Diagnostic Messages .....	52
4.6. Data exchange example .....	53
4.6.1. PLC receives DO status from Modbus master .....	55
4.6.2. PLC refreshes DI status to Modbus master.....	57
4.6.3. PLC changes DO status of Modbus slave .....	59
4.6.4. PLC receives DI status from Modbus slave.....	61
<b>5. MiniOS7 Utility Tool.....</b>	<b>63</b>
5.1. Installing the MiniOS7 Utility .....	63
5.2. Using MiniOS7 Utility to get Ethernet settings and firmware version .....	64
<b>6. PFN_Tool Utility.....</b>	<b>66</b>
6.1. Installing the PFN_Tool Utility .....	66
6.2. PFN_Tool Utility Functionalities .....	67
6.2.1. Module Search .....	67
6.2.2. Module Basic Configuration.....	68
6.2.3. Module Advanced Configuration.....	70
<b>7. Configuration with Web Browser .....</b>	<b>80</b>
7.1. Connecting to Web Server .....	80
7.2. Web Configuration .....	81
<b>8. Troubleshooting .....</b>	<b>87</b>
<b>9. Appendix.....</b>	<b>88</b>
9.1. Modbus Exception Code .....	88

# 1. Introduction

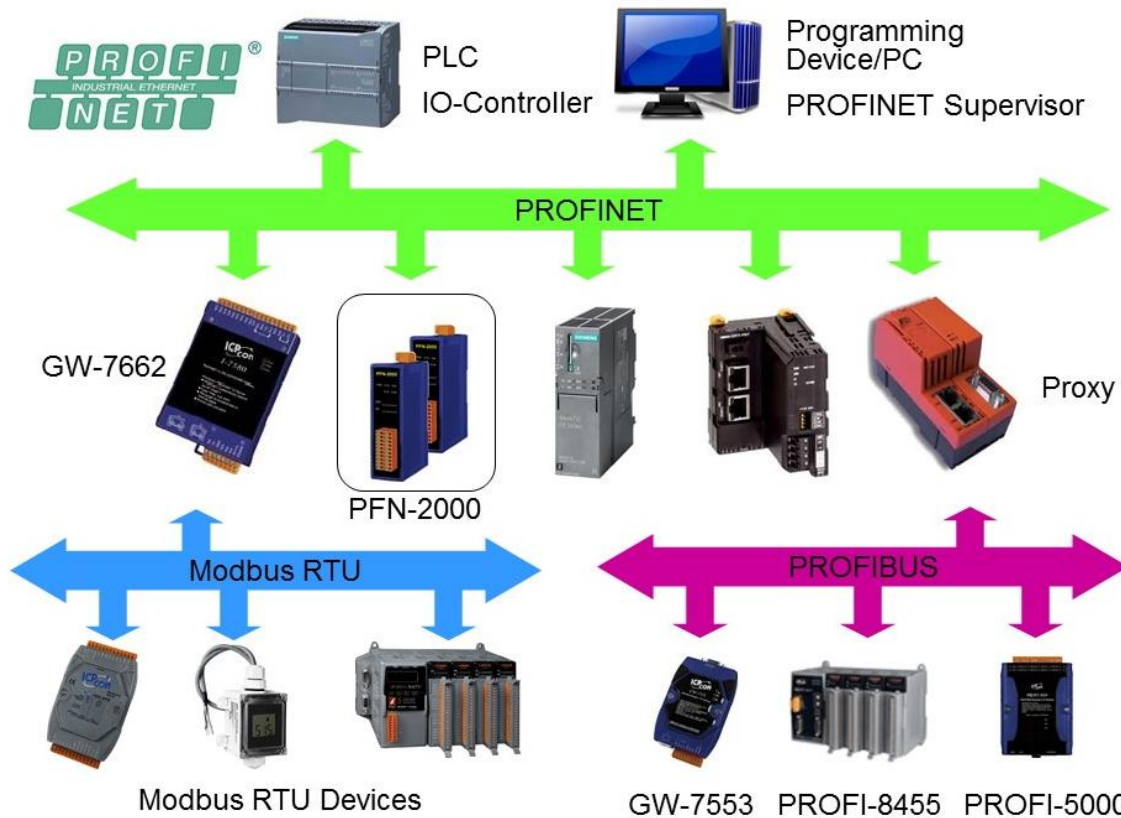

PROFINET is an open Industrial Ethernet standard developed by the PROFIBUS Organization (PI). Based on Ethernet versatility, PROFINET make vertical integration of field level with Enterprise level easily. PROFINET is automation in real time, so it can cover all requirements of the Automation Industry. PROFINET is fit for factory automation, process automation, safety applications and motion control applications, etc.

PROFINET contains 2 different solutions. They are PROFINET IO and PROFINET CBA (Component Based Automation). GW-7662 module are PROFINET IO device. The user can access and configure the modules easily by using the GSDML file in any PROFINET Engineering tool, and exchange process data quickly with the IO controller.

## 1.1. Features

- ◆ **Transfer protocol: PROFINET IO**
- ◆ **Supported Ethernet services: ICMP, IGMP, ARP, DHCP, TELNET, TFTP, SNMP, VLAN Priority Tagging**
- ◆ **Supported PROFINET services: RTC, RTA, CL-RPC, DCP, LLDP, I&M**
- ◆ **PROFINET Conformance Class B and RT Class 1**
- ◆ **Cyclic Time: 1ms (min)**
- ◆ **Generic GSDML File Provided**
- ◆ **Max. Input / Output data :512 / 512 bytes**
- ◆ **Support Modbus Master and Slave mode**
- ◆ **Support Modbus RTU and ASCII format**
- ◆ **Support several kinds of baud rate for COM1 from 1.2 to 460.8 kbps**
- ◆ **Built-in self-tuner ASIC controller on RS-422/485 port**
- ◆ **Integrated 2-Port Switch**
- ◆ **Automatic MDI / MDI-X Crossover for Plug-and-play**
- ◆ **Provide LED indicators**
- ◆ **Robust, fan less design**
- ◆ **4 kV Contact ESD protection for any terminal**
- ◆ **Wide range of power input (+10 ~ +30 VDC) and operating temperature (-25 ~ +75°C)**

## 1.2. Specification

Hardware	
<b>CPU</b>	32-bit CPU Core
<b>RAM/Flash/EEPROM</b>	32 MB / 4 MB / 8 KB
<b>Watchdog</b>	CPU built-in
<b>ESD Protection</b>	4 kV class A

PROFINET Interface	
<b>Protocol</b>	PROFINET IO Device
<b>Conformance Classes</b>	Class B
<b>Services</b>	RTC, RTA, CL-RPC, DCP, LLDP, I&M
<b>Cycle Time</b>	1 ms (min.)

Ethernet Interface	
<b>Controller</b>	10/100Base-TX Ethernet Controller (Auto-negotiating, Auto_MDIX)
<b>Connector</b>	RJ-45 x 2 (LED indicators) , Integrated 2-Port Switch
<b>Services</b>	ICMP, IGMP, ARP, DHCP, TELNET, TFTP, SNMP, VLAN Priority Tagging

UART Interface	
<b>COM</b>	RS-232/RS-422/RS-485 (can't be used simultaneously)
<b>COM Connector</b>	3-pin screwed terminal block (RxD, TxD, GND) 4-pin screwed terminal block (RxD+, RxD-, TxD+, TxD-) 2-pin screwed terminal block (DATA+, DATA-)
<b>Baud Rate (bps)</b>	1200, 2400, 4800, 9600, 19200, 38400, 57600, 115200, 230400, 460800
<b>Data bit</b>	7, 8

<b>Stop bit</b>	1
<b>Parity</b>	None, Even, Odd

<b>LED Display</b>	
<b>Round LED</b>	AP LED, BOOT LED, ERR LED

<b>Power Requirements</b>	
<b>Power supply</b>	Unregulated +10 ~ +30 VDC
<b>Protection</b>	Power reverse polarity protection, Over-voltage brown-out protection
<b>Power Consumption</b>	3.4 W

<b>Mechanical</b>	
<b>Dimensions</b>	42 mm x 76 mm x 119 mm (W x L x H)
<b>Installation</b>	DIN Rail or Wall mounting

<b>Environment</b>	
<b>Operating Temperature</b>	-25 °C ~ +75 °C
<b>Storage Temperature</b>	-30 °C ~ +80 °C
<b>Humidity</b>	10~ 90 % RH, non-condensing



# 1.3. Internal I/O Structure

GW-7662 Internal I/O Structure

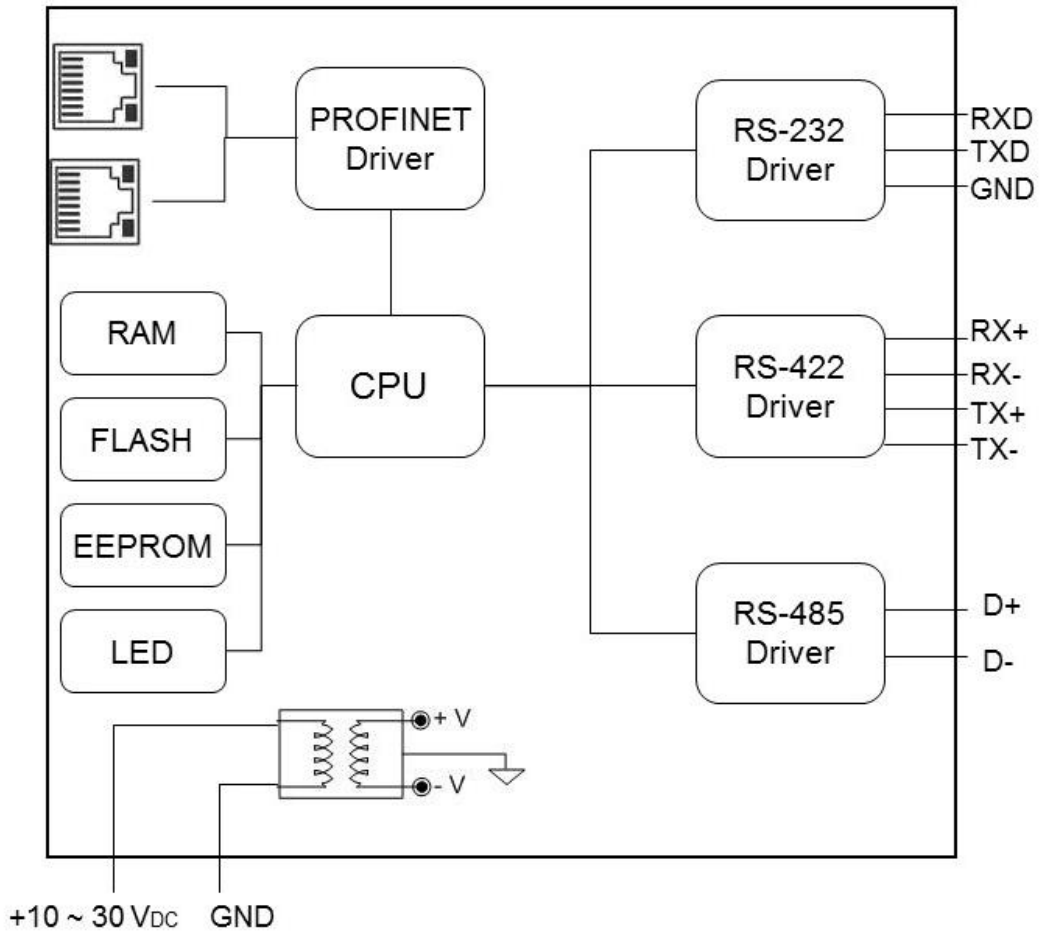

## 1.4. Pin Assignment

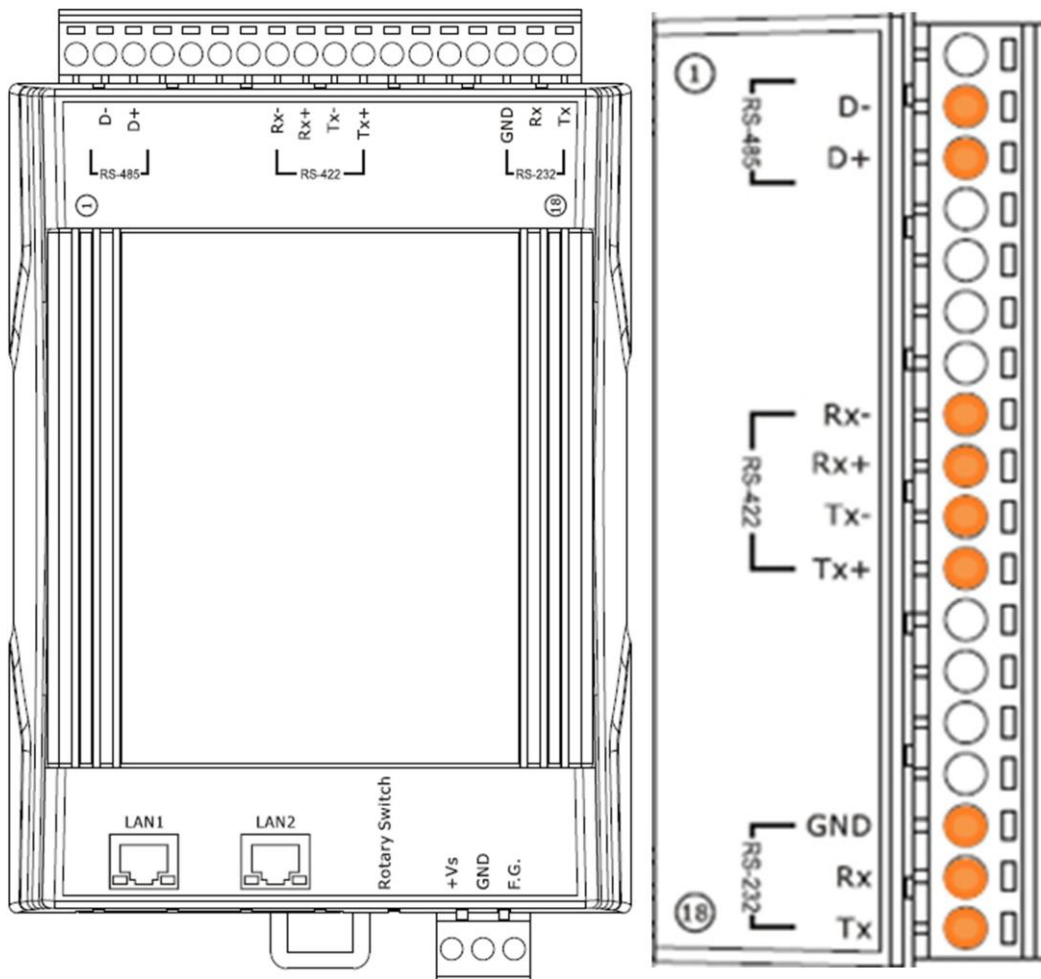

Pin	Name	Description
1	-	N/A
2	D-	Data- of RS-485
3	D+	Data+ of RS-485
4	-	N/A
5	-	N/A
6	-	N/A
7	-	N/A
8	Rx-	Receive Data- of RS-422
9	Rx+	Receive Data+ of RS-422

10	Tx-	Transmit Data- of RS-422
11	Tx+	Transmit Data+ of RS-422
12	-	N/A
13	-	N/A
14	-	N/A
15	-	N/A
16	GND	GND of RS-232
17	Rx	Receive Data of RS-232
18	Tx	Transmit Data of RS-232

## 1.5. Overview

Here is a brief overview of the components and its descriptions for module status.

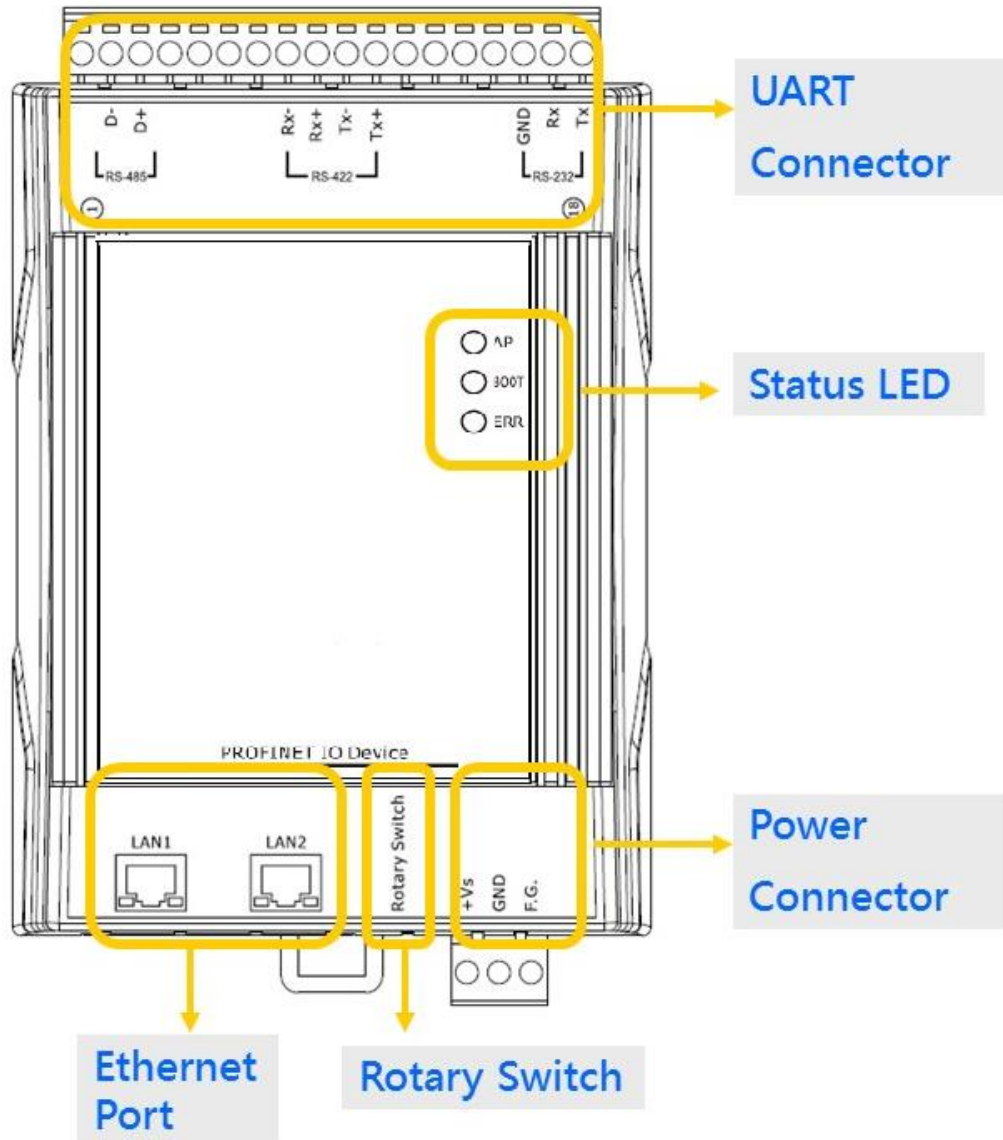

### ► UART Connector

For more detailed information regarding the pin assignments of the UART Connector, please refer to “1.4. Pin Assignment”

## ► Status LED Indicators

---

AP mode:

AP	BOOT	ERR	Description
OFF	OFF	Flash (Slow)	waiting for PROFINET connection
ON	OFF	OFF	PROFINET connection is established.
ON	OFF	Flash (Slow)	Device is at AP mode and the module received the incorrect parameters.
ON	OFF	Flash (Fast)	Error! GW-7662 has diagnostic message.
ON	Flash (Slow)	Flash (Slow)	Hardware authentication error!

Bootloader mode:

AP	BOOT	ERR	Description
ON	ON	OFF	waiting for Ethernet link
OFF	ON	OFF	Ethernet link established, waiting for IP address acquired
Flash (Slow)	ON	OFF	IP address acquired, waiting for telnet connection
ON	ON	OFF	Telnet connection is established.

Flash(Slow): about 500ms      Flash(Fast): about 100ms

## ► Ethernet Ports

---

An Ethernet port is an opening on GW-7662 network equipment that Ethernet cables plug into. Ethernet ports accept cables with RJ-45 connectors.

### Tips & Warnings

---



1. When users connect GW-7662 and switch, users should not connect LAN1 and LAN2 to switch at the same time, else it will lead to abnormal network.
2. When users connect network devices by daisy chain topology, users can connect these devices in series by LAN1 and LAN2.

## ► Rotary Switch

---

Position	Mode	Module configuration
0	AP mode	Output: 32 bytes Input: 32 bytes
1	AP mode	Output: 64 bytes Input: 64 bytes
2	AP mode	Output: 128 bytes Input: 128 bytes
3	AP mode	Output: 256 bytes Input: 256 bytes
4	AP mode	Output: 384 bytes Input: 384 bytes
5	AP mode	Output: 512 bytes Input: 512 bytes
6~7	AP mode	Reserved
8~F	Bootloader mode	N/A

## Tips & Warnings

---



If AP LED turn on, BOOT LED turn off and ERR LED flash slow. It means that the value of rotary switch does not match the settings of the modules(please refer to section 4.2. Module configuration).

---

### ► Power Connector

---

Pin Name	Function
+VS	10 ~ 30 VDC power input
GND	Ground connection
F.G.	Frame ground connection

## 1.6. Wiring and Jumper Setting Instructions

It is recommended to use only one serial port (RS232, RS485 or RS422) of the converter at the same time. The following section describes the necessary steps to be taken to connect one of the three COM port types to a serial device or serial network. The pull high/low resistor of COM port is shown in below.

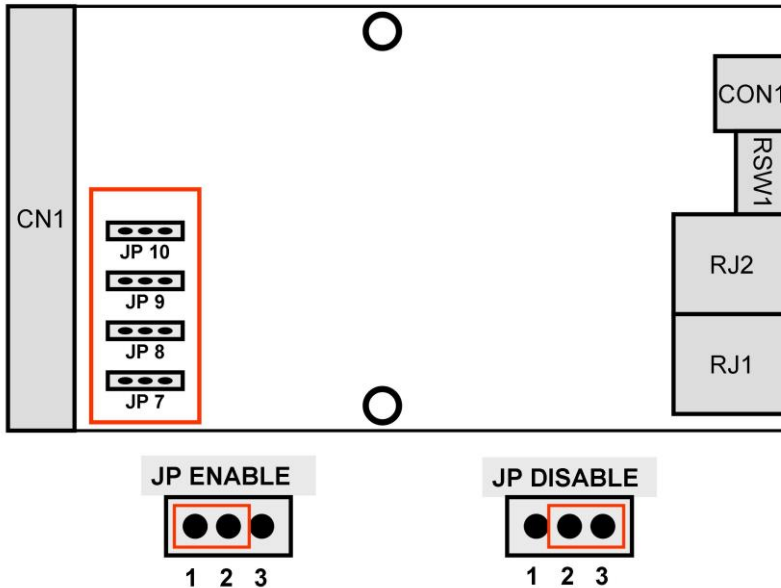

### 1.6.1. RS-232 Connection

The RS-232 port of the GW-7662 has got three pins.

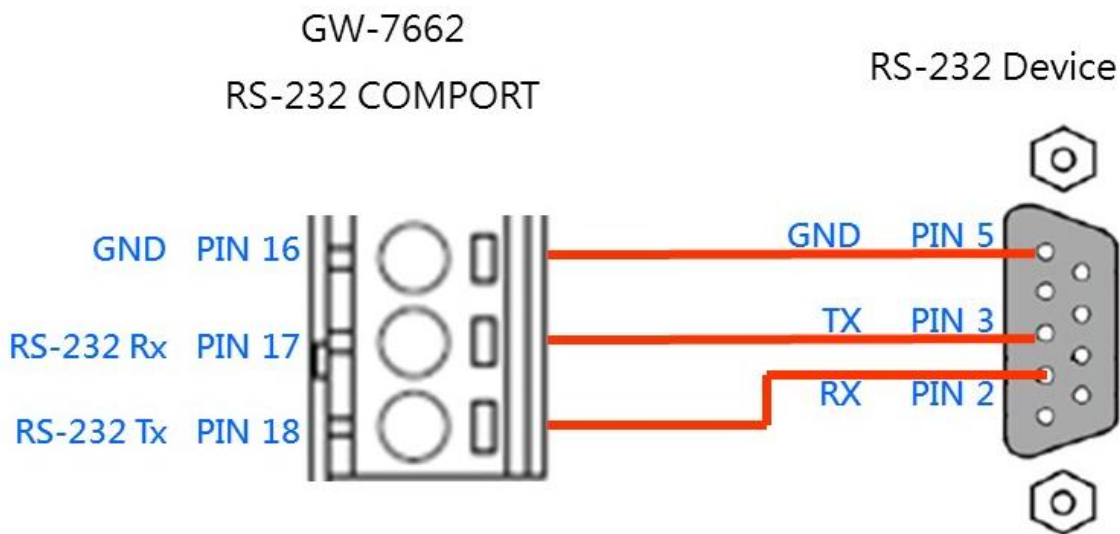



## 1.6.2. RS-422 Connection

The GW-7662 converter is always a PROFINET IO device but it can in a local RS-422 network either take the position of a master or that of a slave. Depending on whether the converter acts as a local master or as a slave and on the number of devices connected to the RS-422 network device the four jumpers provided by the module has to be set. The jumpers set the pull high and pull down resistors for the RS-422 port.

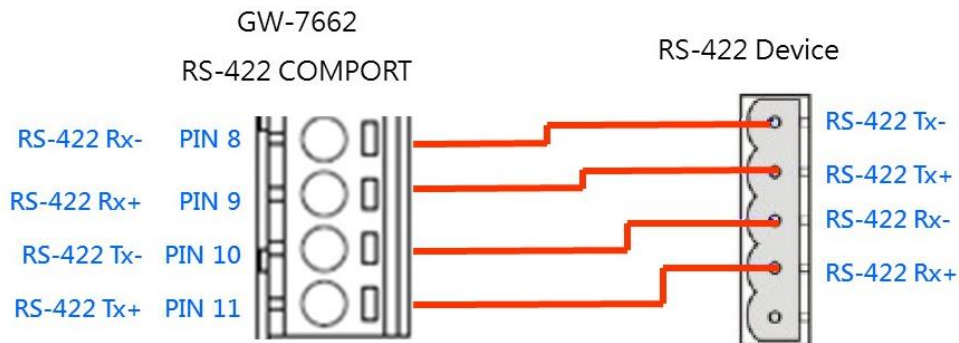

### ► Configuration of pull high/low resistor for the RS-422 port

Pull High / Low resistor	Condition
Enable (default)	The GW-7662 is the master in RS-422 bus or The number of devices connected to the RS-422 bus is less than 10
Disable	The GW-7662 is a slave in RS-422 bus or The number of devices connected to the RS-422 bus is more than 10



### 1.6.3. RS-485 Connection

The GW-7662 converter can only act in the PROFINET network as a slave. In a RS-485 network however it can either be a local master or slave. Before the module is connected to a RS-485 network it is important to know whether the module takes the place of a slave or master and how many devices are active on the RS-485 bus. The two jumpers (JP7 and JP8) have to be set according the bus configuration.

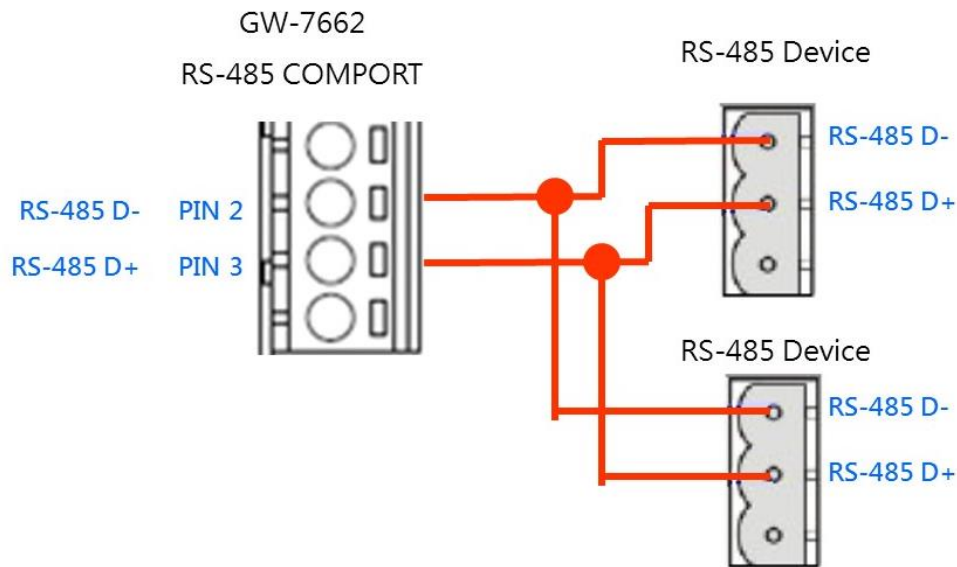

#### ► Configuration of pull high/low resistor for the RS-485 port

Pull High / Low resistor	Condition
Enable (default)	The GW-7662 is the master in RS-485 bus or The number of devices connected to the RS-485 bus is less than 10
Disable	The GW-7662 is a slave in RS-485 bus or The number of devices connected to the RS-485 bus is more than 10

RS-485 Pull High/Low  
resistor enable



1 2 3

JP 7



1 2 3

JP 8

RS-485 Pull High/Low  
resistor disable



1 2 3

JP 7



1 2 3

JP 8

# 1.7. Dimensions

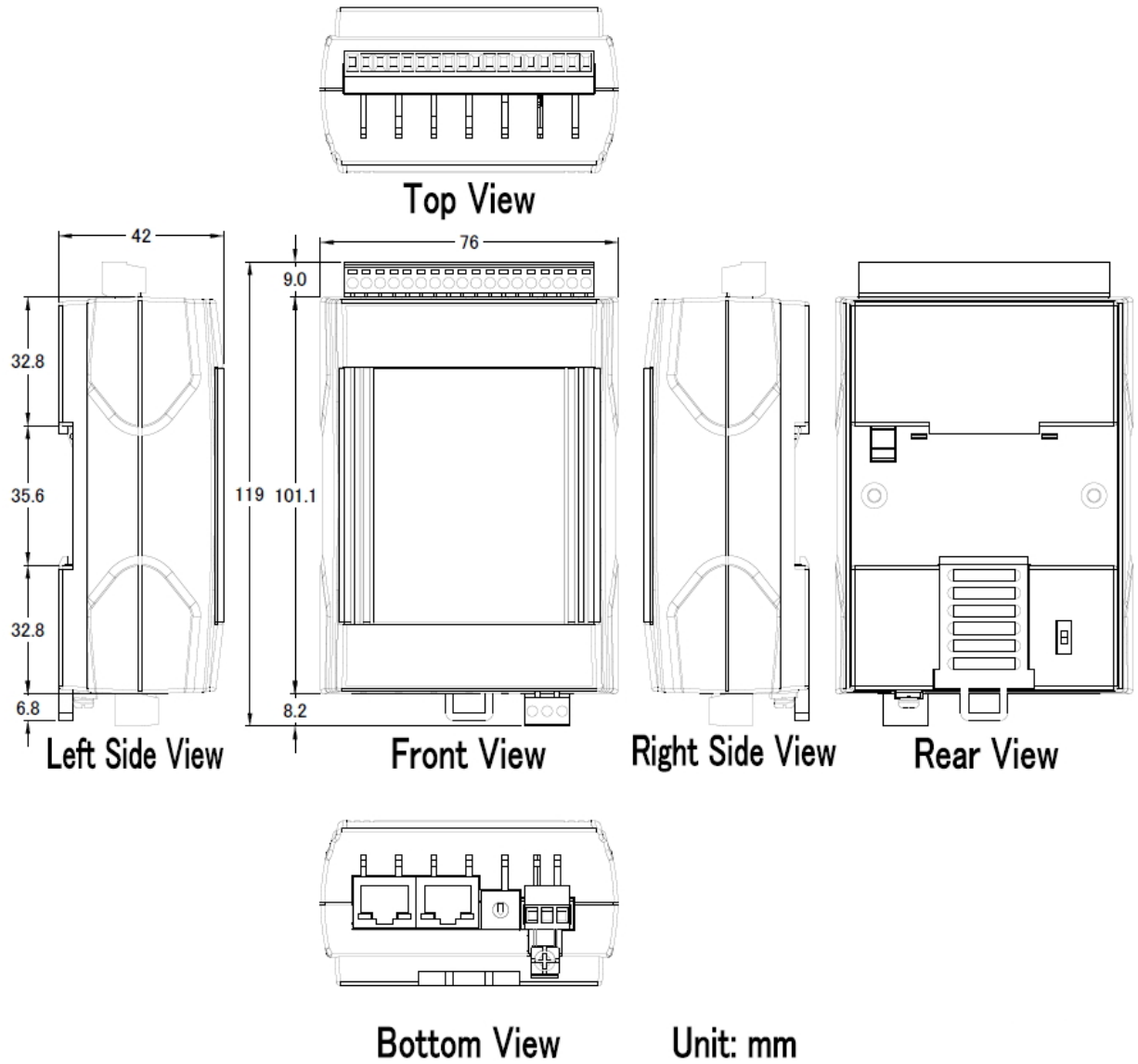

## 2. PROFINET

---

PROFINET contains 2 different solutions. They are PROFINET IO and PROFINET CBA (Component Based Automation). **GW-7662 module is a PROFINET IO device.**

PROFINET IO is used for communication with decentral periphery like IOs, drives, etc.

PROFINET CBA is a communication solution for autonomously acting partial units of machines or plants.

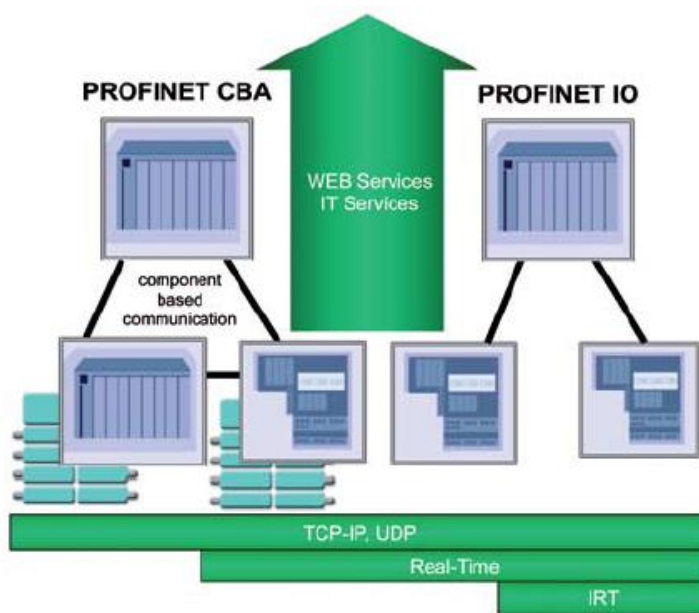

### 2.1. Device classes of PROFINET IO

The following devices classes are defined to facilitate structuring of PROFINET IO field devices.

- ◆ IO-Controller: This is typically a PLC on which the automation program runs
- ◆ IO-Supervisor: This can be a programming device (PG), personal computer (PC), or human machine interface (HMI) device for commissioning or diagnostic purposes.
- ◆ IO-Device: An IO-Device is a distributed I/O field device that is connected via PROFINET IO. It can exchange data with multiple IO-Controllers.

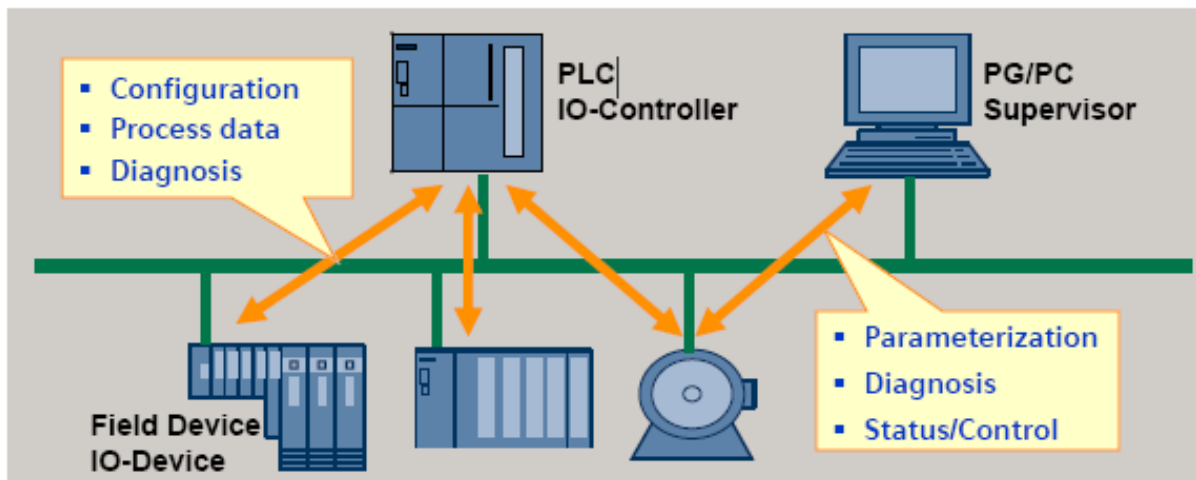

## 2.2. Device Description

The functionality of a PROFINET IO Device is always described in a GSD file. This file contains all data that are relevant for engineering as well as for data exchange with IO-Device.

PROFINET IO-Devices can be described using XML-based GSD. The description language of the GSD file, i.e. GSDML (General Station Description Markup Language) is based on international standards.

Every manufacturer of a PROFINET IO-Device must supply an associated GSD file according to the GSDML specification. Users can access and configure GW-7662 module by using the GSDML file in any PROFINET Engineering tool.

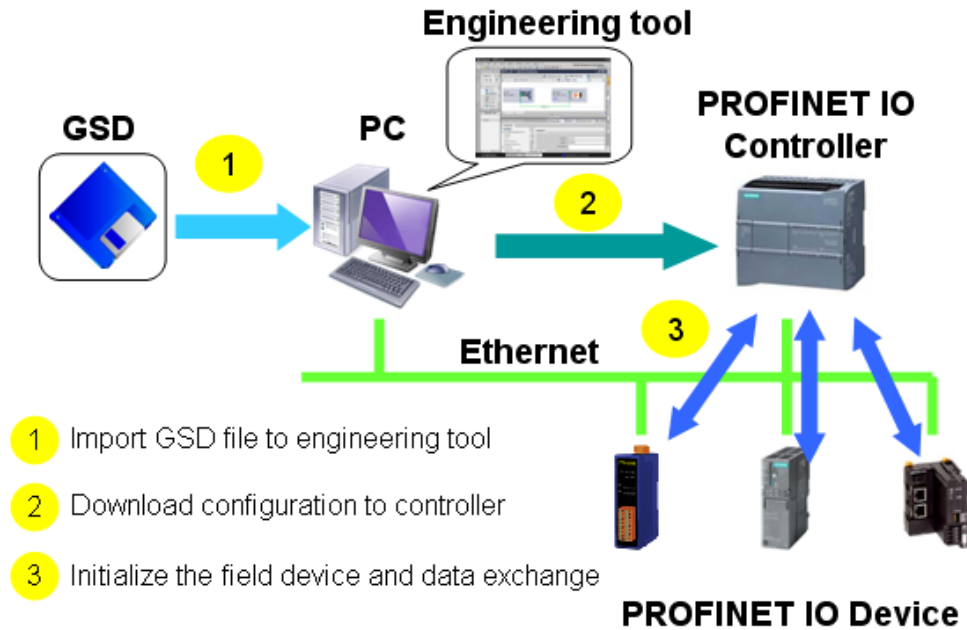

## 2.3. Conformance Classes (CC)

PI has classified the scope of functions in PROFINET IO into 3 conformance classes (CC-A, CC-B, CC-C). Users simply need to select a CC appropriate for system and do not need to worry about any other details to ensure the interoperability in an automation system with regard to the scope of functions and performance parameters.

### CC-A:

Use of the infrastructure of an existing Ethernet network including integration of basic PROFINET functionality. All IT services can be used without restrictions. Examples of typical applications are in building automation and process automation. Wireless communication is only possible in this class.

### CC-B:

In addition to the functions of CC-A, the scope of functions of CC-B supports easy and user-friendly device replacement without the need for an engineering tool. Examples of typical applications are in automation systems with a higher-level machine controller that place relatively low demands for a deterministic data cycle.

### CC-C:

In addition to the functions of CC-B, the scope of functions of CC-C supports high-precision and deterministic data transmission, including for isochronous applications. An example of a typical application is the field of motion control.

### Class C:

- Deterministic data transfer
- Certified devices and network components
- Topmost performance, redundancy

### Class B:

- Certified devices and network components
- Topology determination and upload
- Comfortable Diagnostics, redundancy

### Class A:

- Standard Ethernet Network components
- Certified Devices and Controller

■ Application Class:	non isochronous	non isochronous	Non iso. + isochronous
■ Communication Class:	TCP/IP, RT	TCP/IP, RT	TCP/IP, RT, RT
■ Redundancy:	RedClass 1 optional	RedClass 1, 2 optional	RedClass 1, 2, 3 optional



# 3. Basic Application

---

If you are a new user, begin with this chapter, it includes a guided tour that provides a basic overview of installing, configuring and using the GW-7662.

In the following examples the S7-1200 PLC from Siemens is used to be a PROFINET IO Controller. The configuration and communication is done by the program “Step 7 V11 SP2 (TIA PORTAL)” provided by Siemens.

## 3.1. Connect to Network, PC and PROFINET IO controller

The GW-7662 module is equipped with two RJ-45 Ethernet ports for connection to an Ethernet switch, PC and PROFINET IO controller.

### Tips & Warnings

---



1. When users connect GW-7662 and switch, users should not connect LAN1 and LAN2 to switch at the same time, else it will lead to abnormal network.
2. When users connect network devices by daisy chain topology, users can connect these devices in series by LAN1 and LAN2.

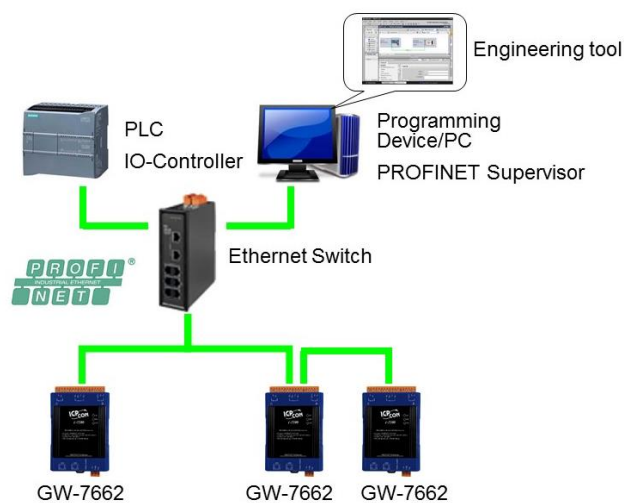

# 3.2. Network configuration

In this example, please follow the below configuration to configure the network.

PC:  
IP: 192.168.6.210  
Mask: 255.255.0.0

PLC:  
Device name: plc1  
IP: 192.168.6.211  
Mask: 255.255.0.0

GW-7662:  
Device name: gw-7662  
IP: 192.168.6.212  
Mask: 255.255.0.0

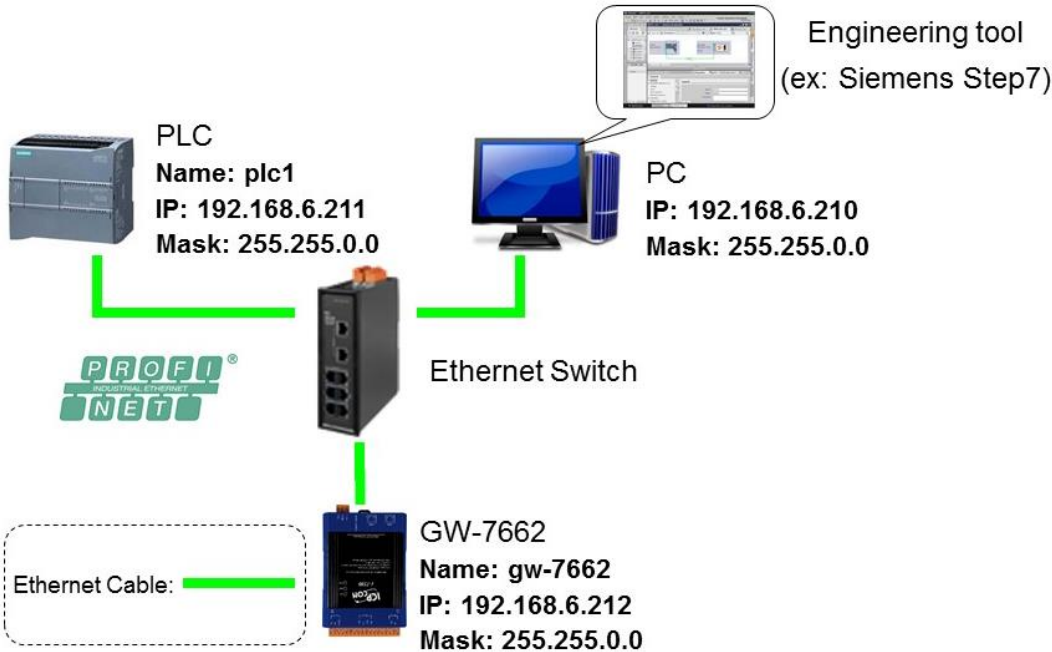

## Step 1: Set PC's IP

- ◆ Click “start->Settings->Network Connections”

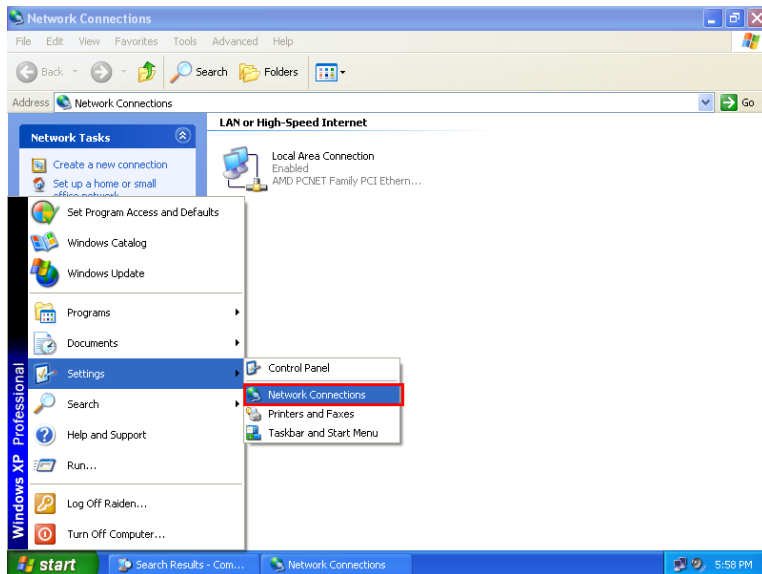

- ◆ Double click “Local Area Connection” icon



- ◆ Click “Properties” button

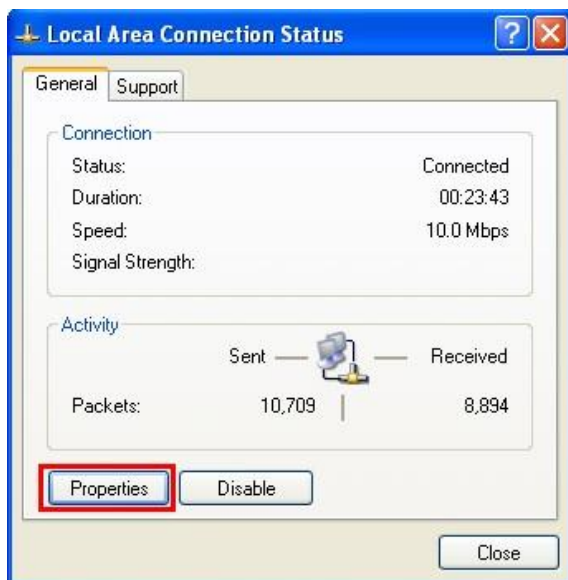

- ◆ Select “Internet Protocol(TCP/IP)” and click “Properties” button

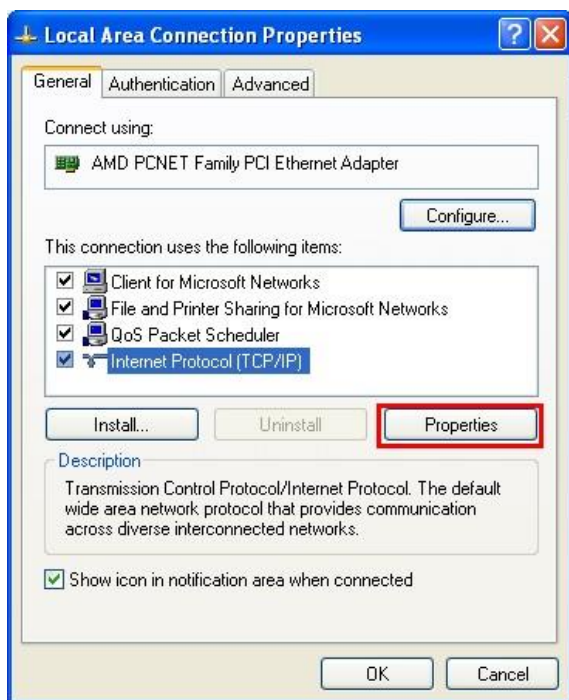

- ◆ Set “Internet Protocol Properties” and then click “OK” button.

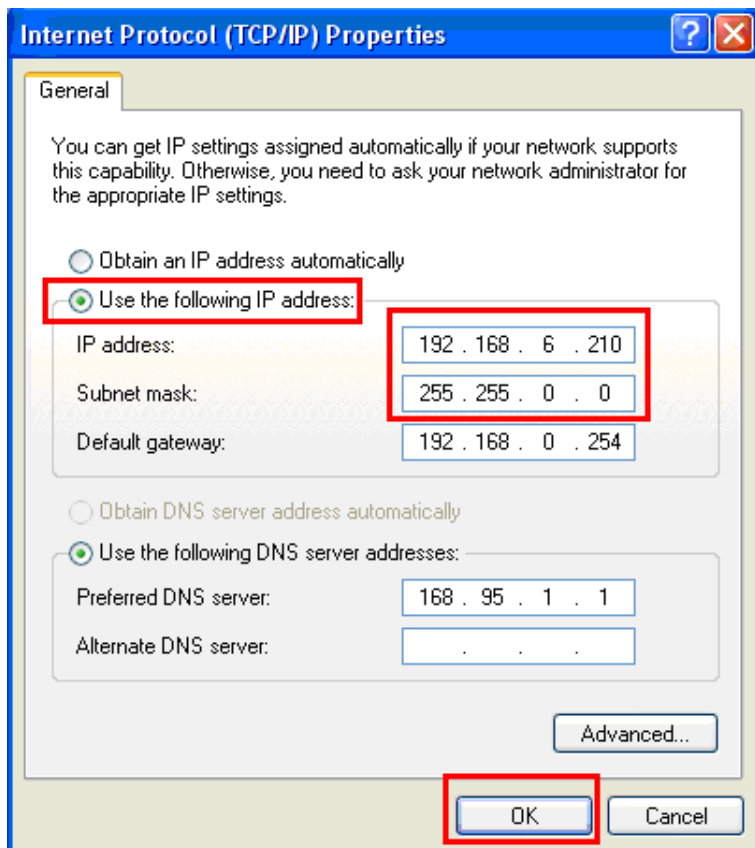

## Step 2: Set PLC's name and IP

- ◆ Double Click TIA icon to start Step 7 V11



- ◆ Click "Project view"

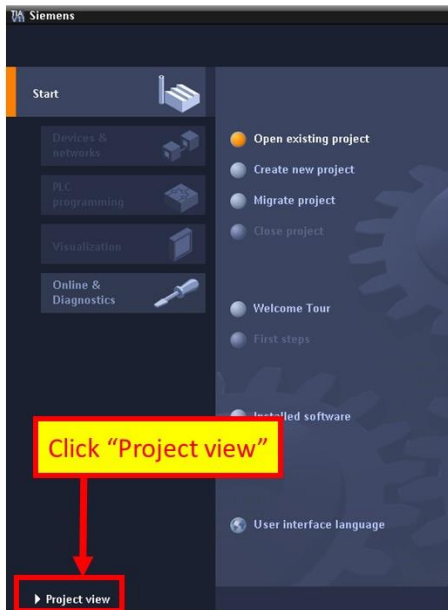

- ◆ Search accessible devices

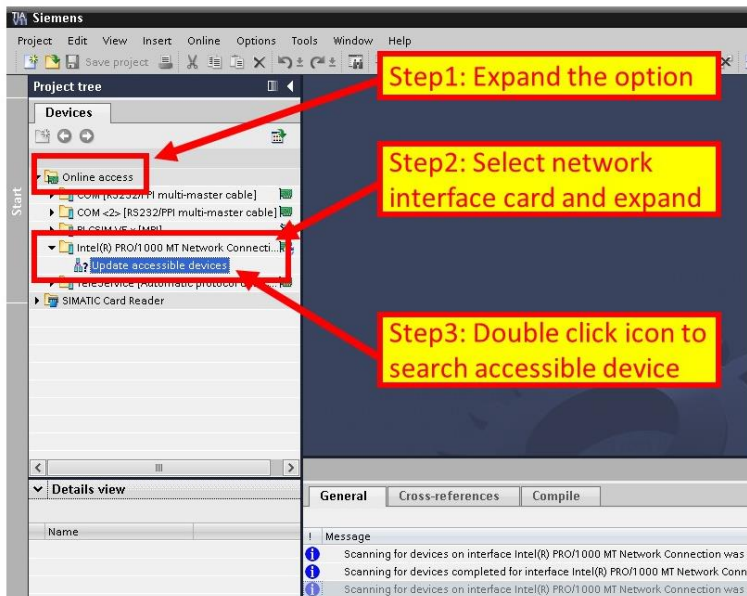

- ◆ Select PLC and click “Online & diagnostics” button

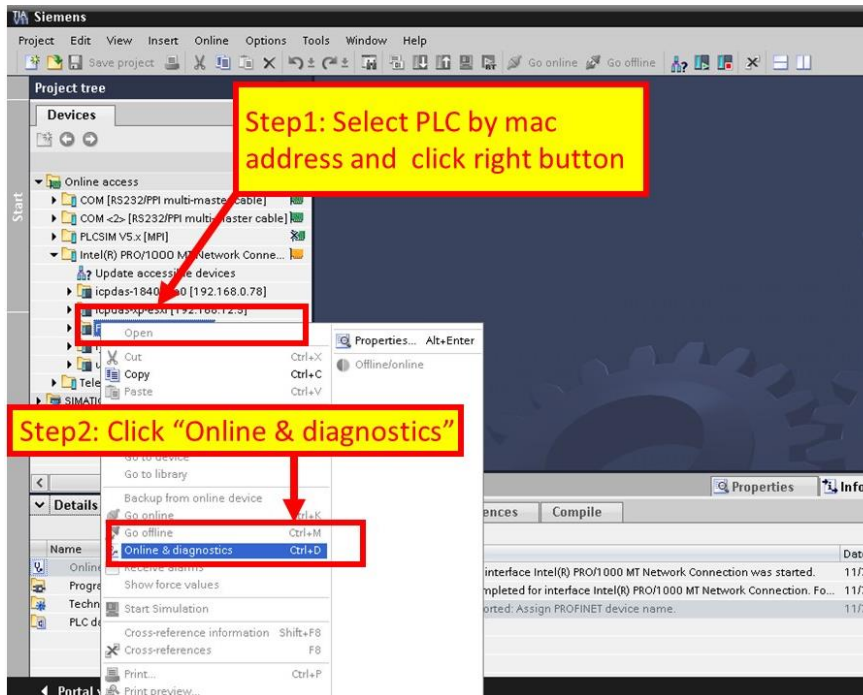

- ◆ Set IP and Mask

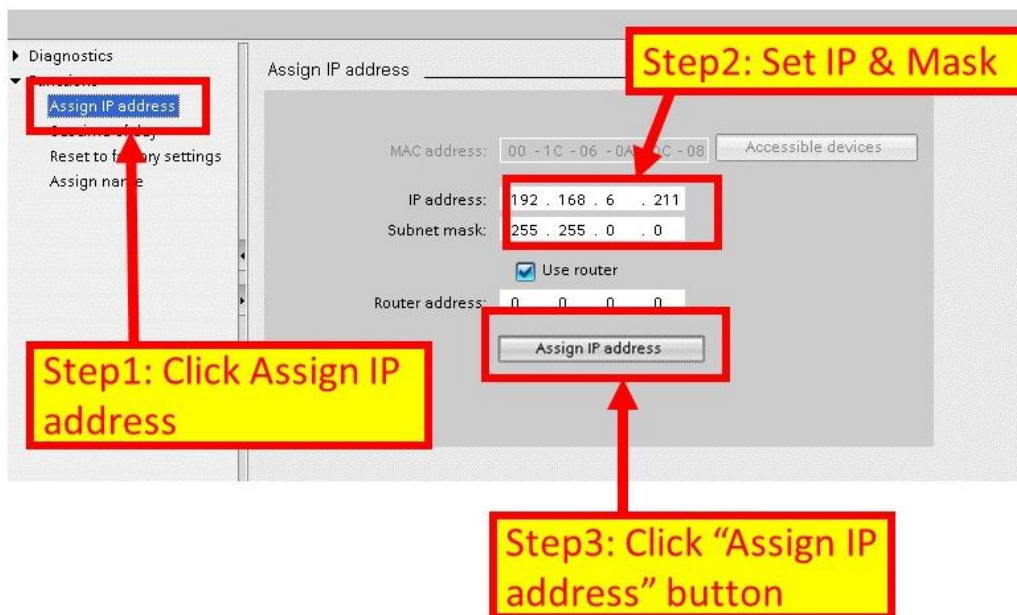

◆ Set device name

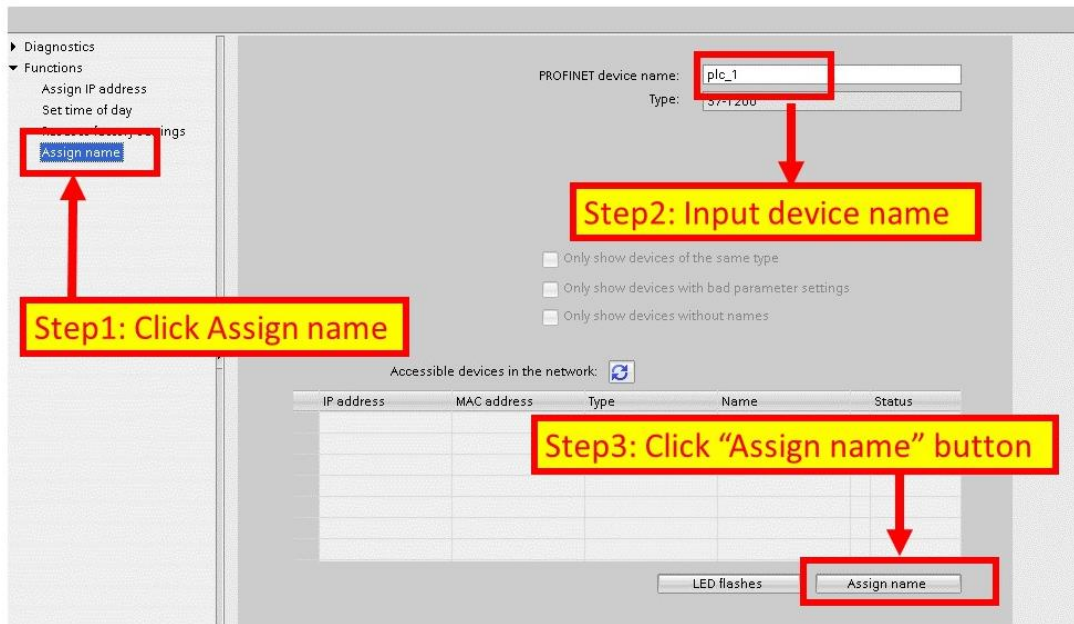

**Step 3: Set GW-7662 module's name and IP**

◆ Search accessible devices

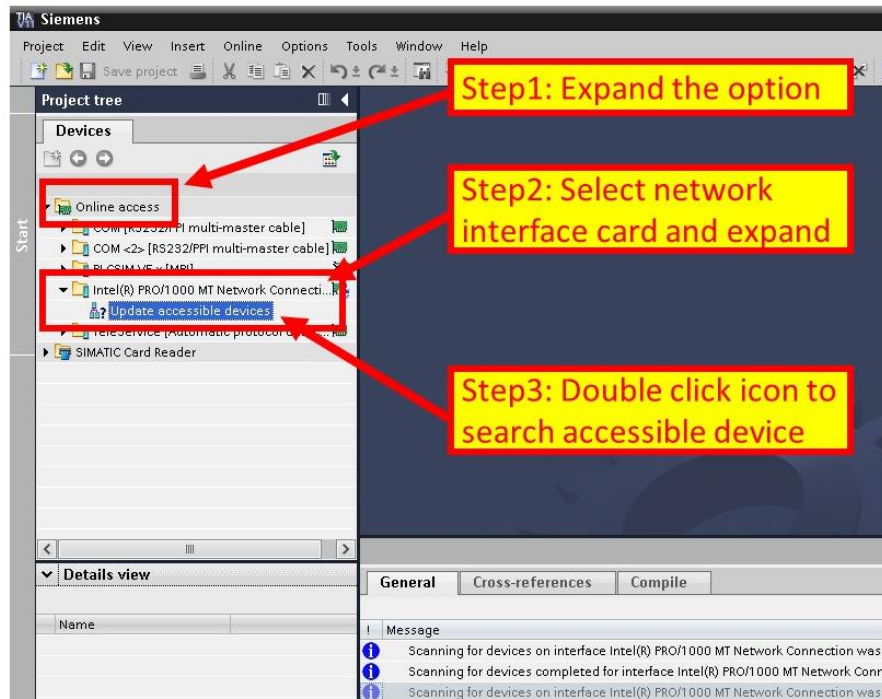

- ◆ Select GW-7662 module and click “Online & diagnostics” button

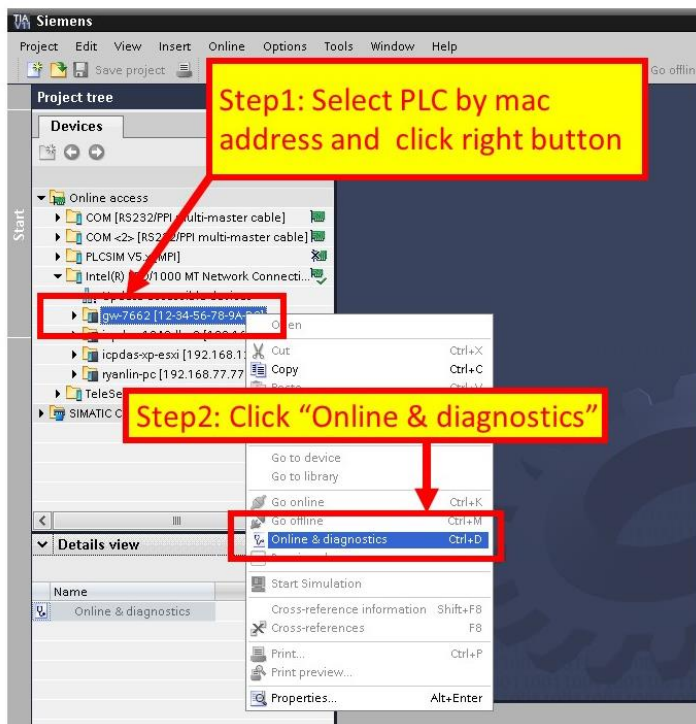

- ◆ Set IP and Mask

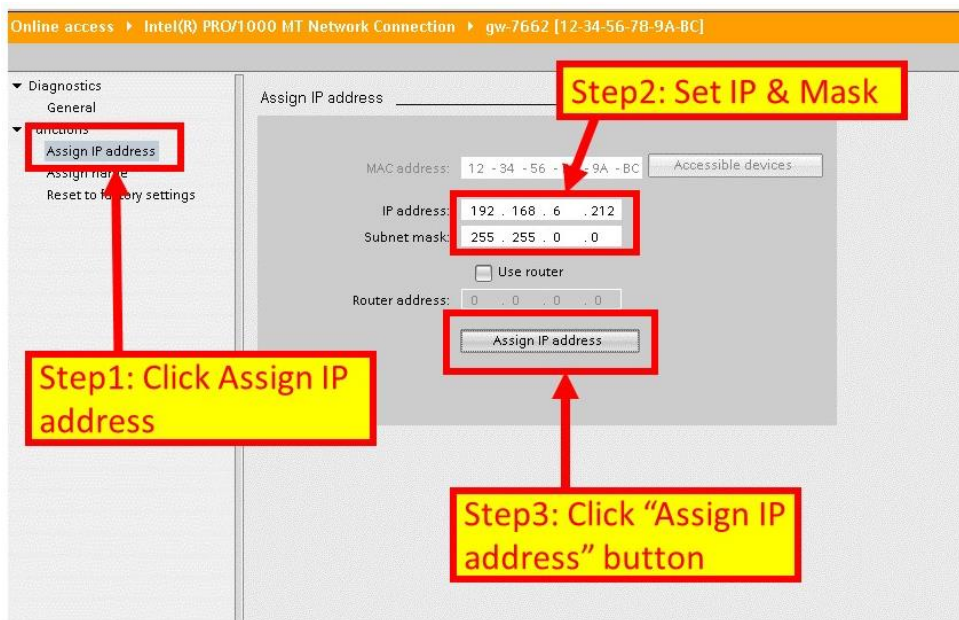



◆ Set device name

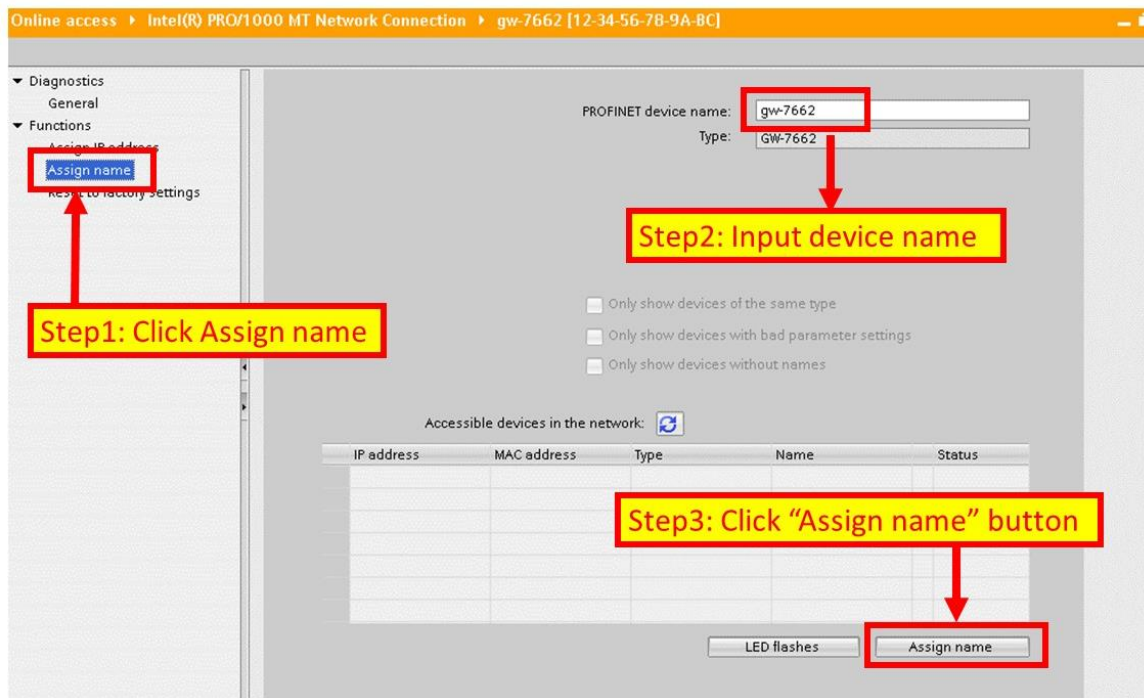

### 3.3. GSD Import

In this example, please follow the step to import GSD file.

#### Step 1: Get GSD file

The GSD file can be obtained from companion CD or our FTP site:

CD: \fieldbus\_cd\profinet\gateway\gw-7662\gsd\  
[ftp://ftp.icpdas.com/pub/cd/fieldbus\\_cd/profinet/gateway/gw-7662/gsd/](ftp://ftp.icpdas.com/pub/cd/fieldbus_cd/profinet/gateway/gw-7662/gsd/)

#### Step 2: Import GSD file

- ◆ Double Click TIA icon to start Step 7 V11



- ◆ Click "Project view"

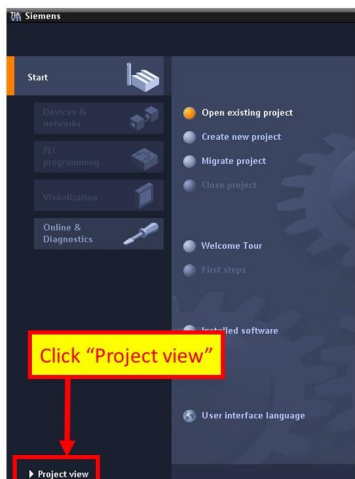

- ◆ Select “Menu->Options->Install general station description file (GSD)”

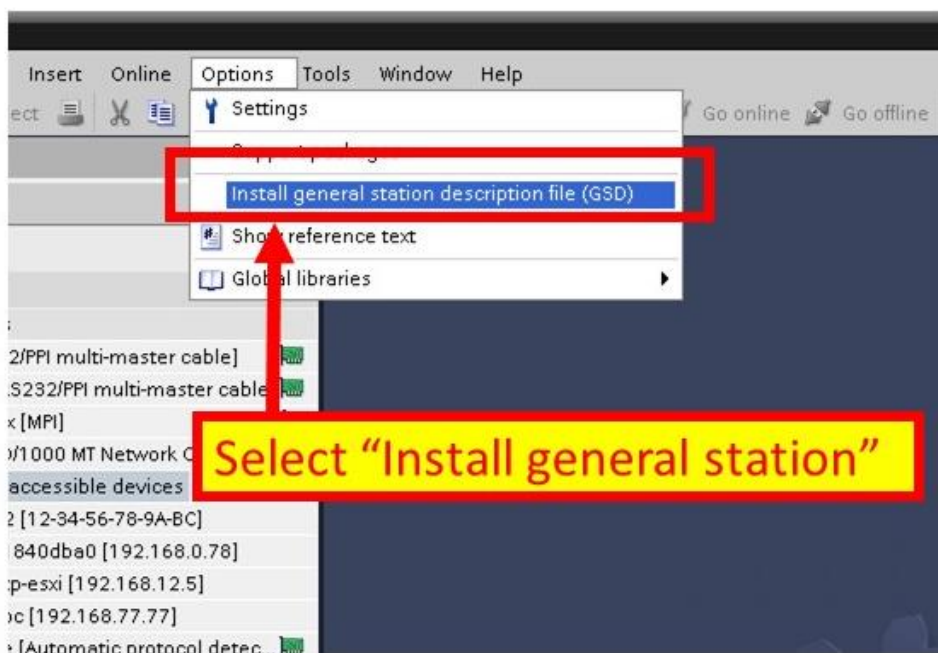

- ◆ Select and install GSD file

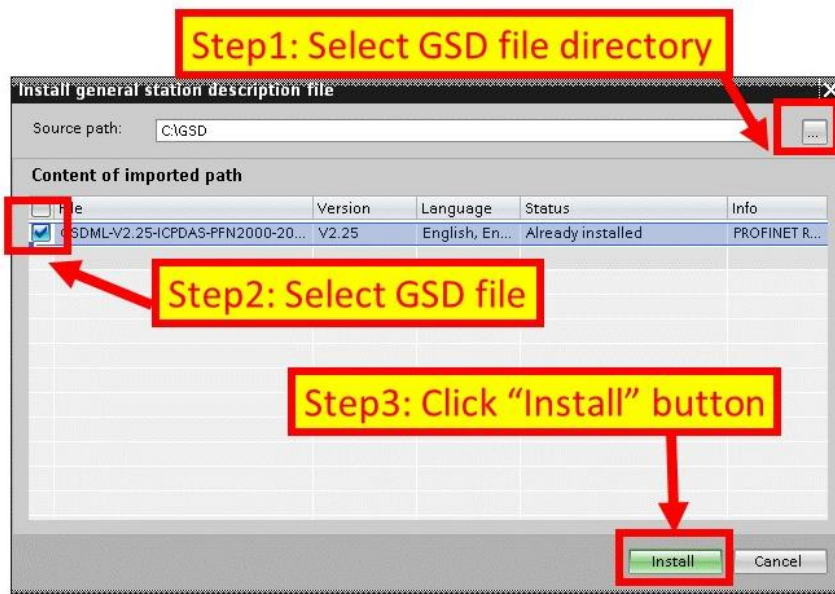

# 3.4. Project Setup

In this example, please follow the step to setup project.

**Step 1: Create the project**

- ◆ Double Click TIA icon to start Step 7 V11

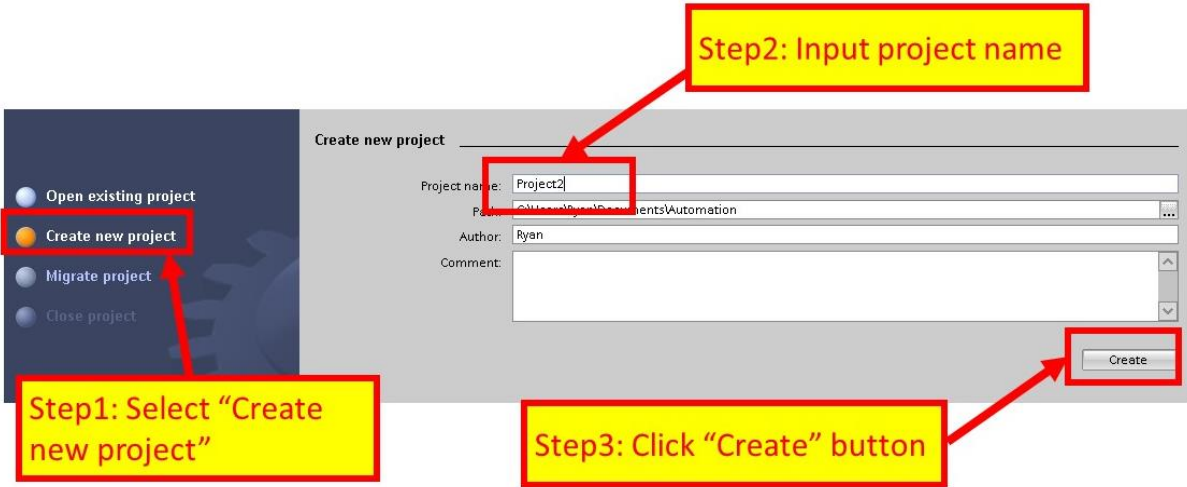

- ◆ Create the Project

A screenshot of the 'Create new project' dialog box in TIA Portal. The dialog has a sidebar on the left with four radio buttons: 'Open existing project', 'Create new project' (selected), 'Migrate project', and 'Close project'. The main area contains fields for 'Project name' (with 'Project2' entered), 'Path' (with 'C:\Users\Ryan\Documents\Automation' entered), 'Author' (with 'Ryan' entered), and a 'Comment' text area. A 'Create' button is at the bottom right. Three yellow callout boxes with red arrows point to: 1) 'Create new project' in the sidebar, 2) the 'Project name' field, and 3) the 'Create' button.

## Step 2: Project configuration

### ◆ Add a PLC device

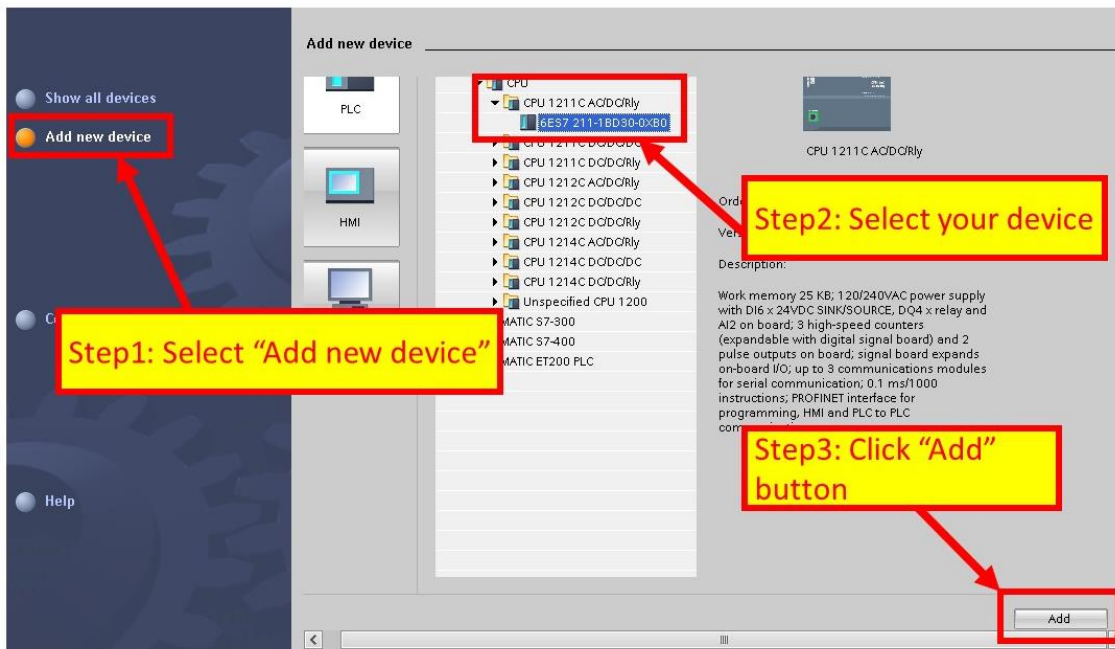
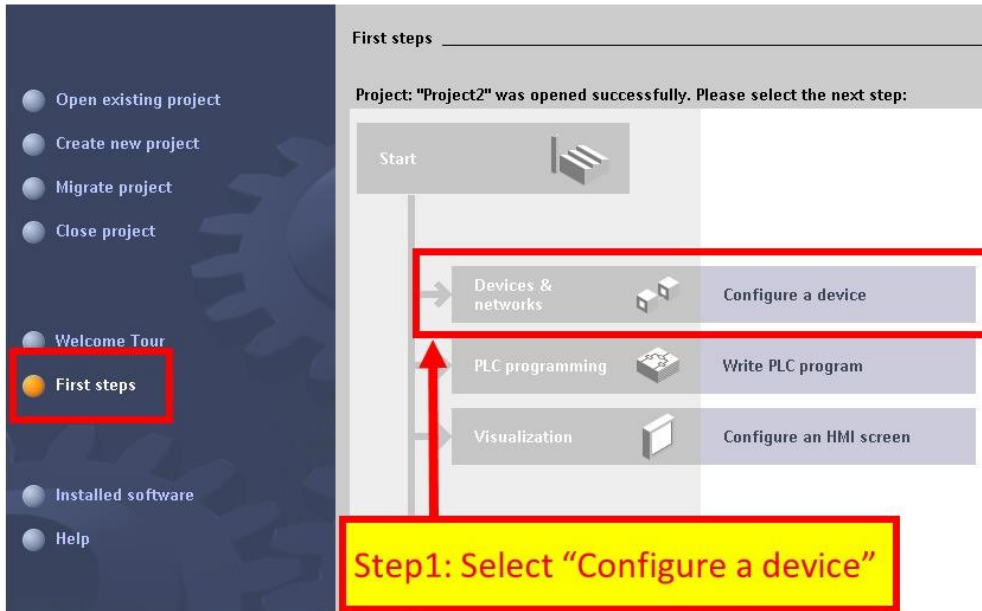

- ◆ Set the device name of PLC to “PLC\_1”

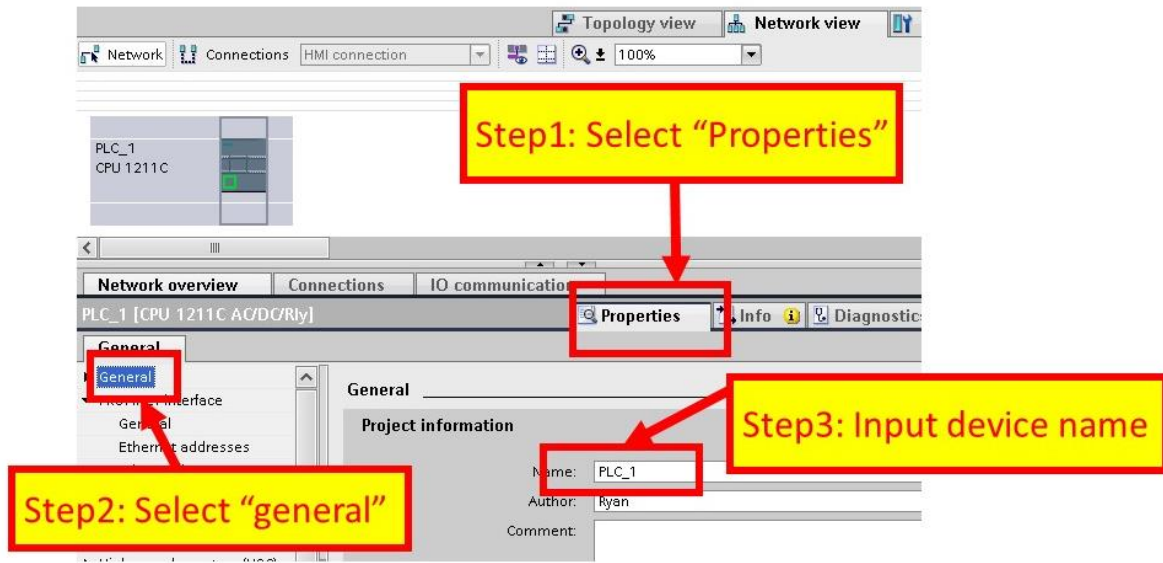

- ◆ Set the IP and mask of PLC and add a new subnet

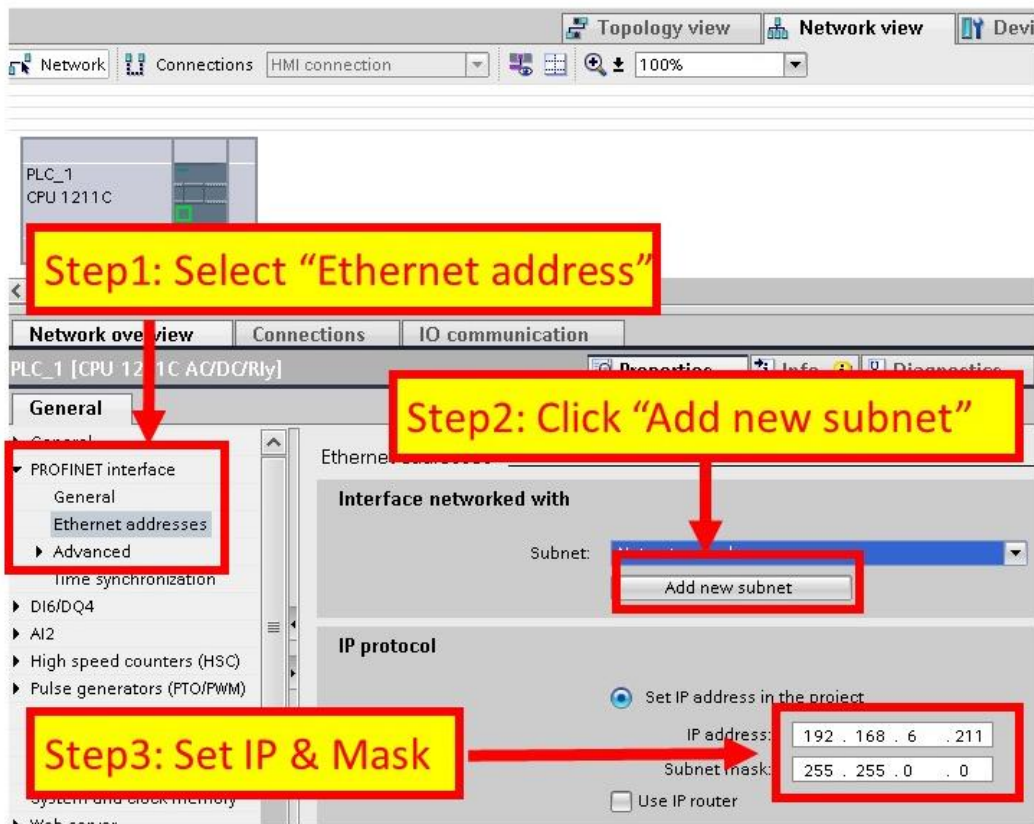

◆ Add GW-7662 module

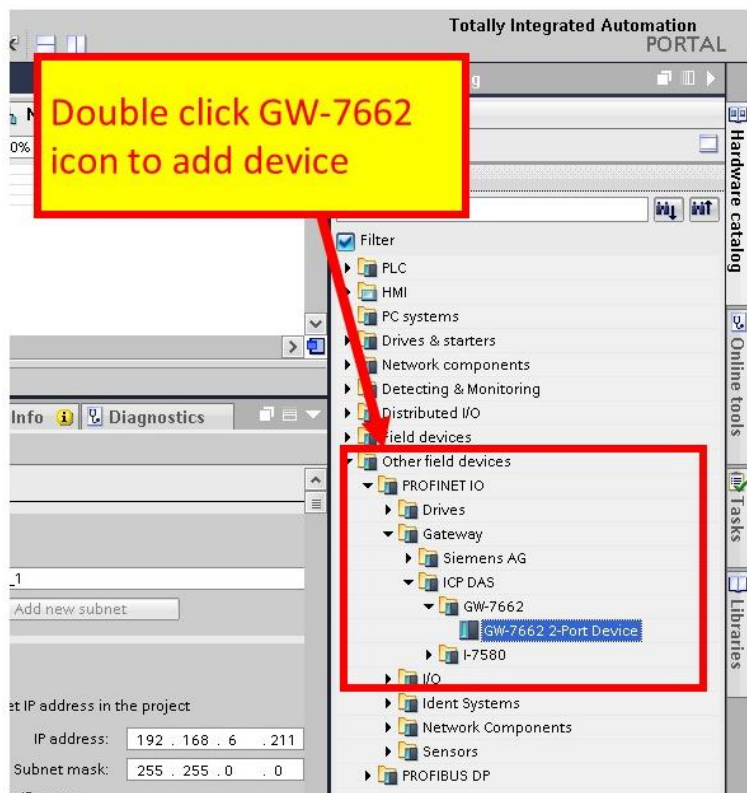

◆ Select PROFINET interface

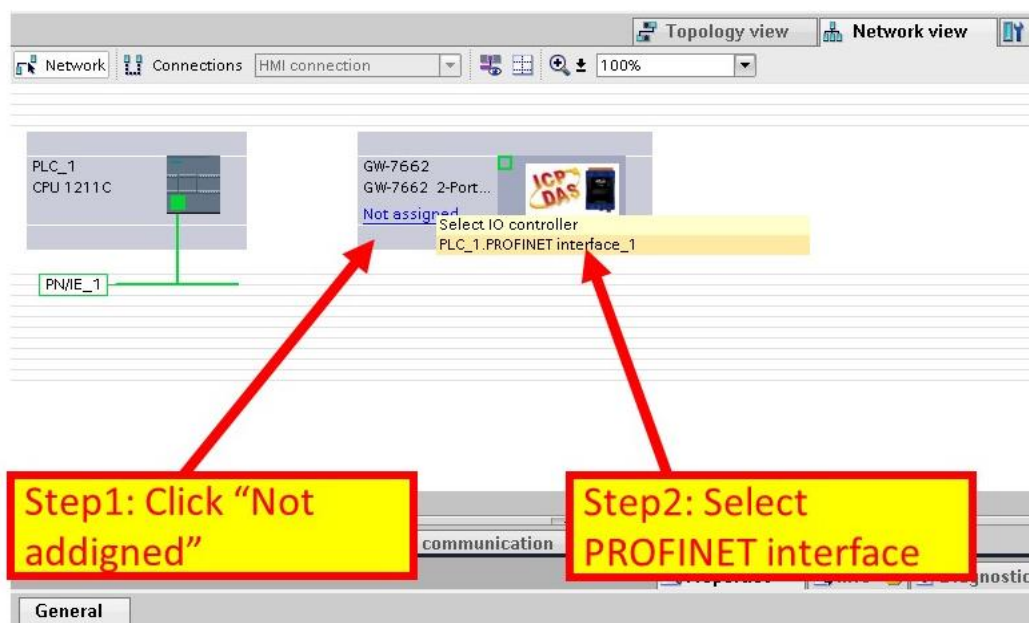

- ◆ Set device name to “gw-7662”

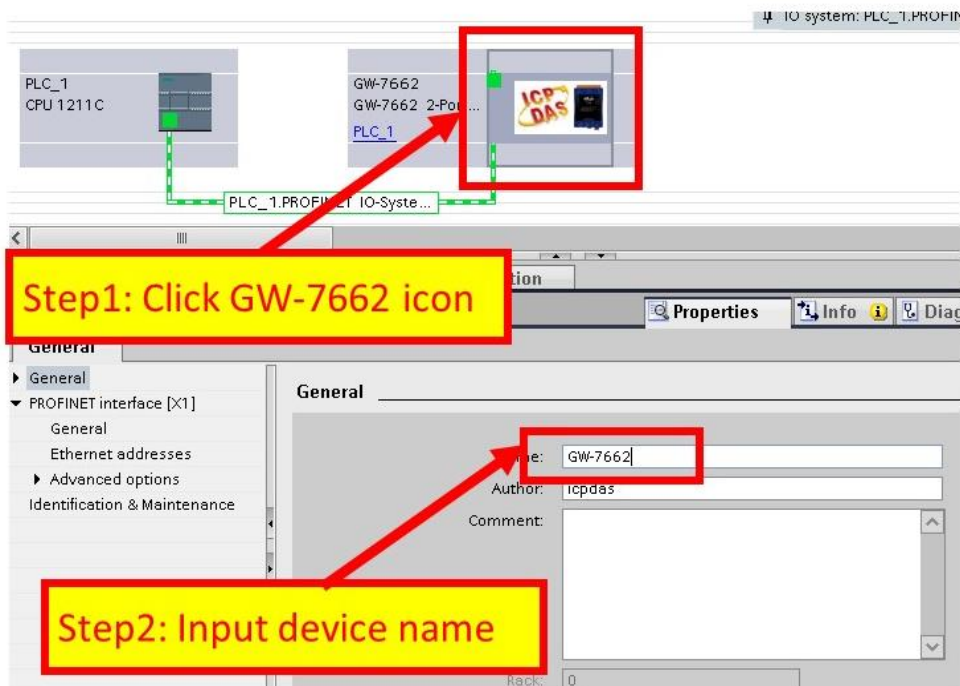

- ◆ Set the IP of GW-7662 module

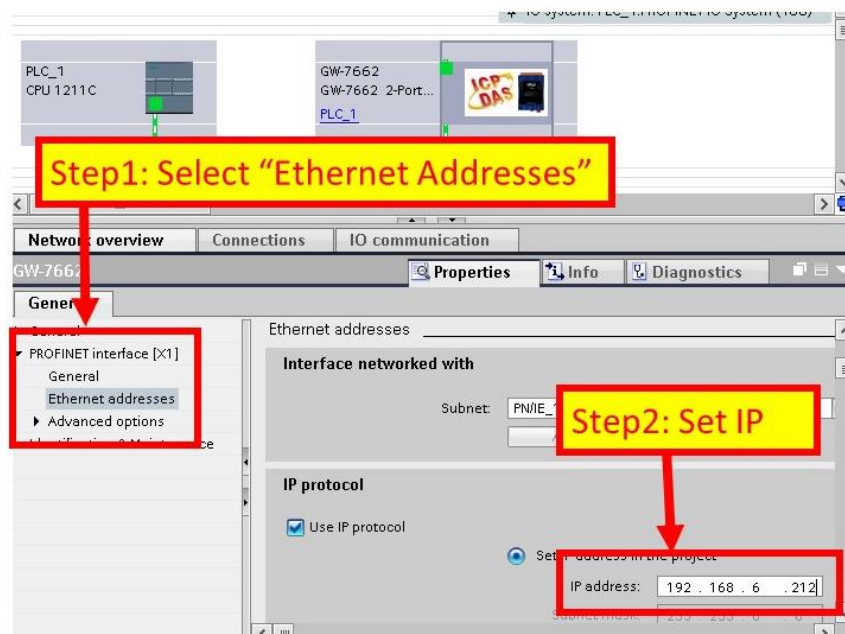



◆ Select module type of GW-7662 module

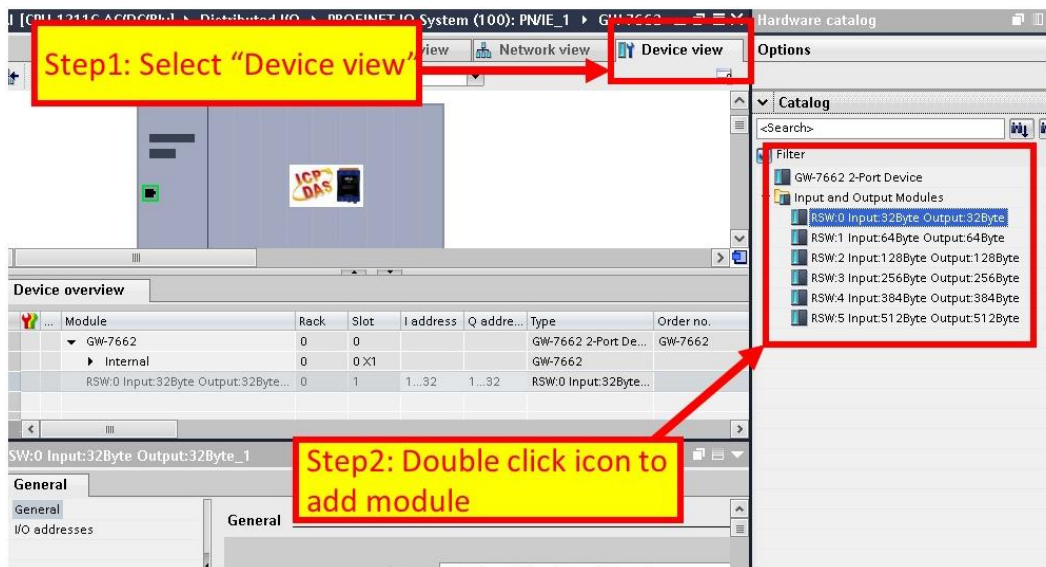

◆ Compile and download to device

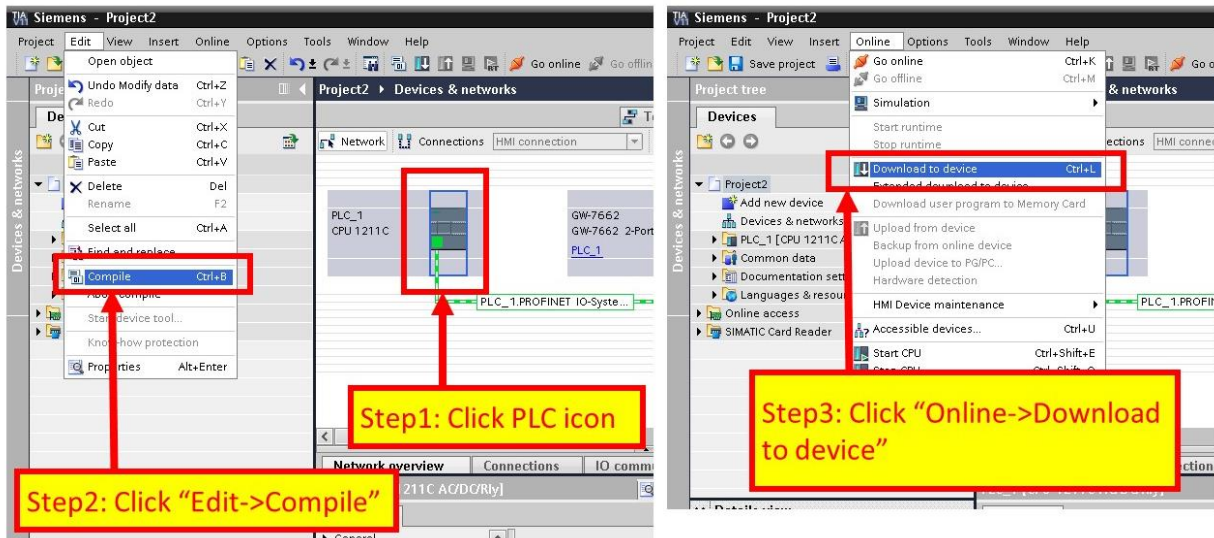

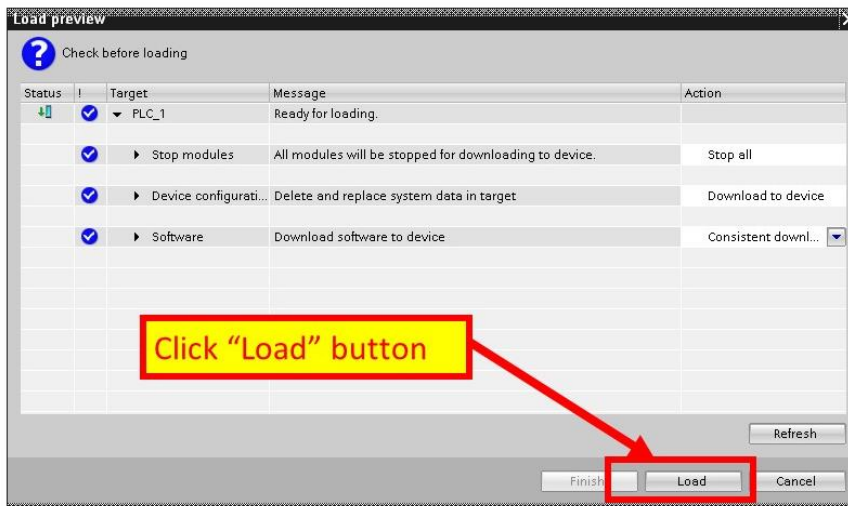
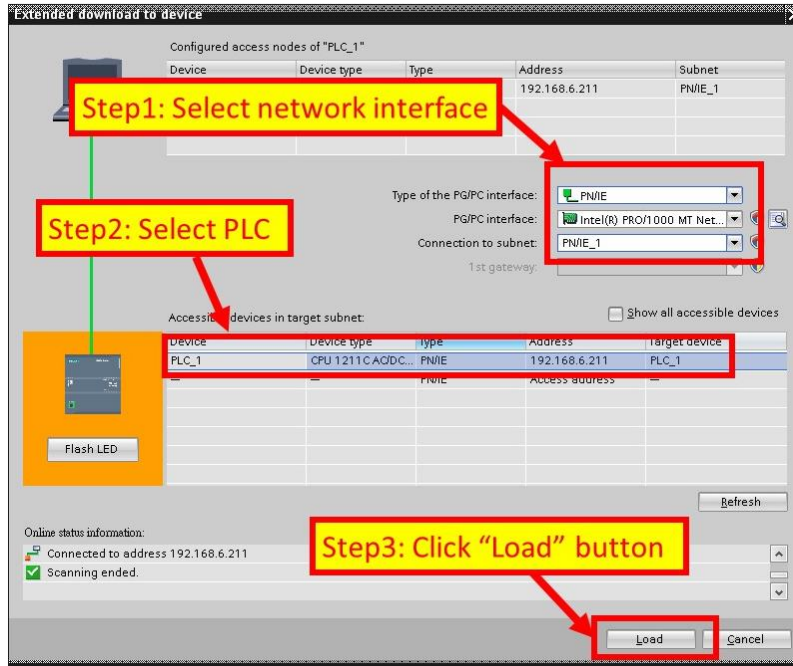

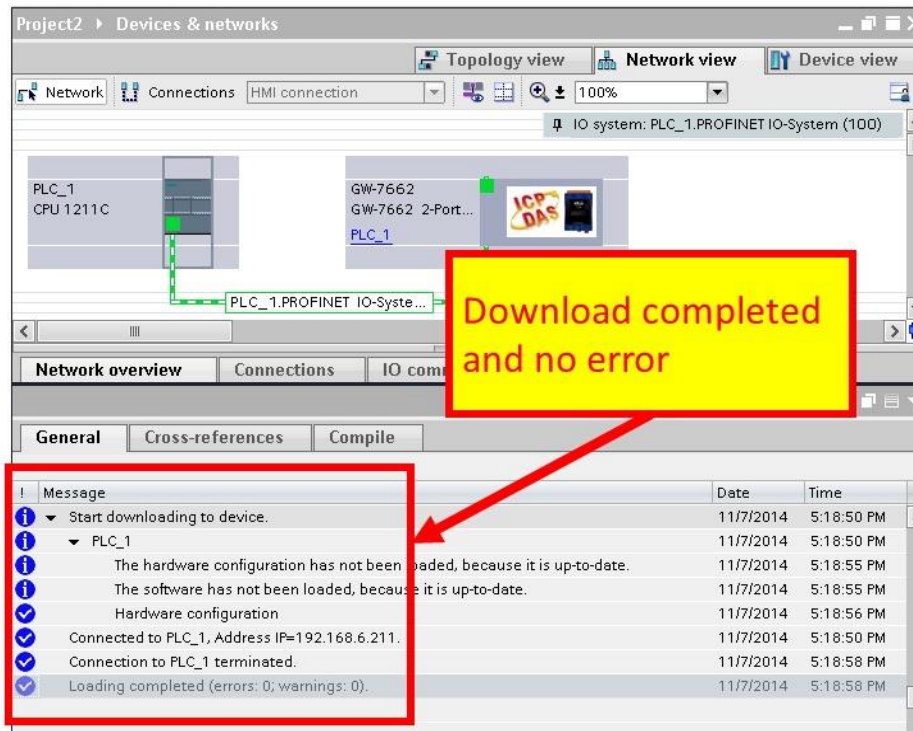
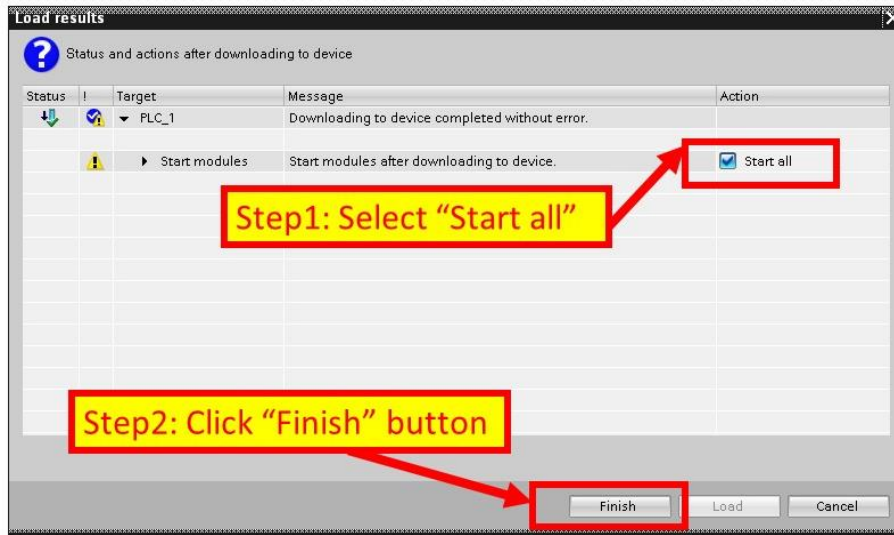

**At this time, the AP LED should turn on, BOOT LED and ERR LED should turn off, it means the connection between PLC and GW-7662 module is established.**

## 4. Communication

---

### 4.1. Communication Sequence

GW-7662 module has basically got 6 buffers:

- PROFINET IO device input buffer
- PROFINET IO device output buffer
- DI buffer
- DO buffer
- AI buffer
- AO buffer

PROFINET IO controller has basically got 2 buffers:

- PROFINET IO controller input buffer
- PROFINET IO controller output buffer

#### PROFINET Data Exchange

During each message cycle PROFINET IO controller writes the content of its output buffer to PROFINET IO device input buffer and reads the content of PROFINET IO device output buffer to its input buffer. The exchange cycle is taking place even though the content of the PROFINET IO controller and PROFINET IO device output buffer has not changed. The data flow between PROFINET IO controller and GW-7662 is shown in below.

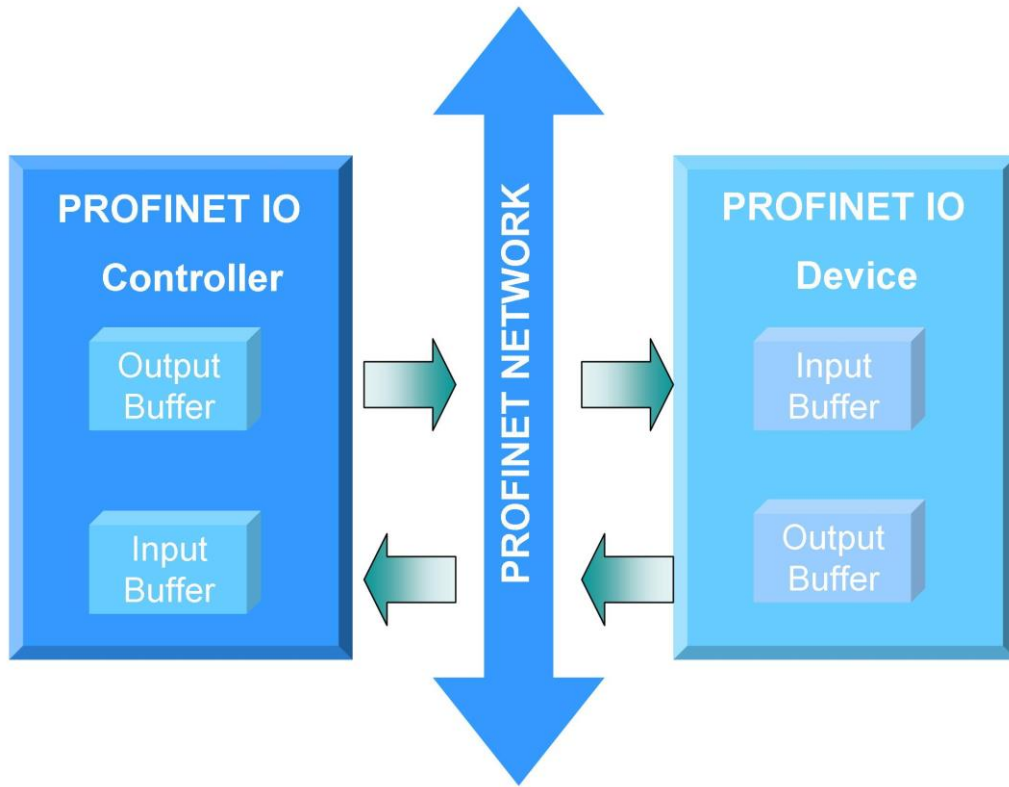

### Modbus Data Exchange – Master mode

When GW-7662 acts as a Modbus master device, it can get query message through parameters set by PFN\_Tool Utility and DO, AO buffer, and then send query message to Modbus slave device. It can also receive response message from Modbus slave device and then saving to internal DI, AI buffer.

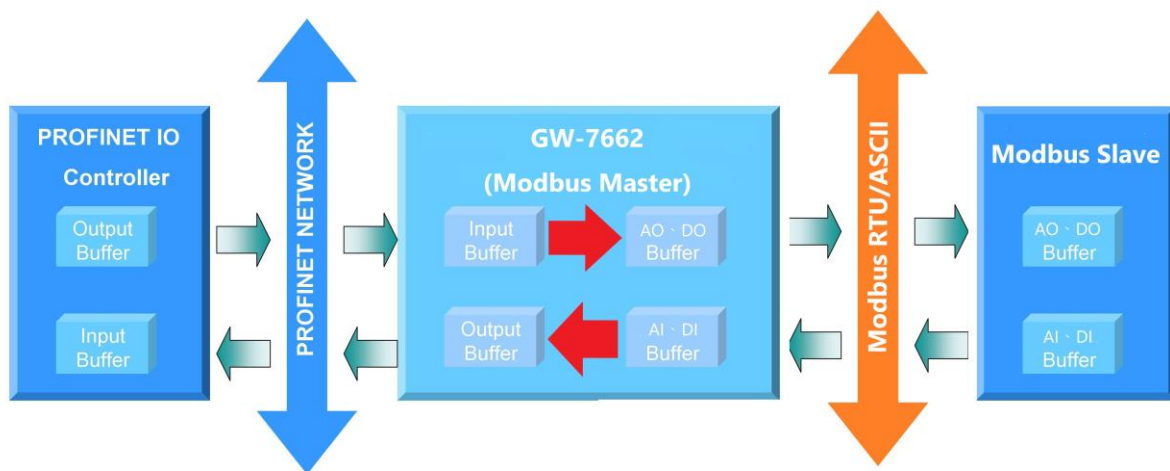

## GW-7662 send data to Modbus slave device

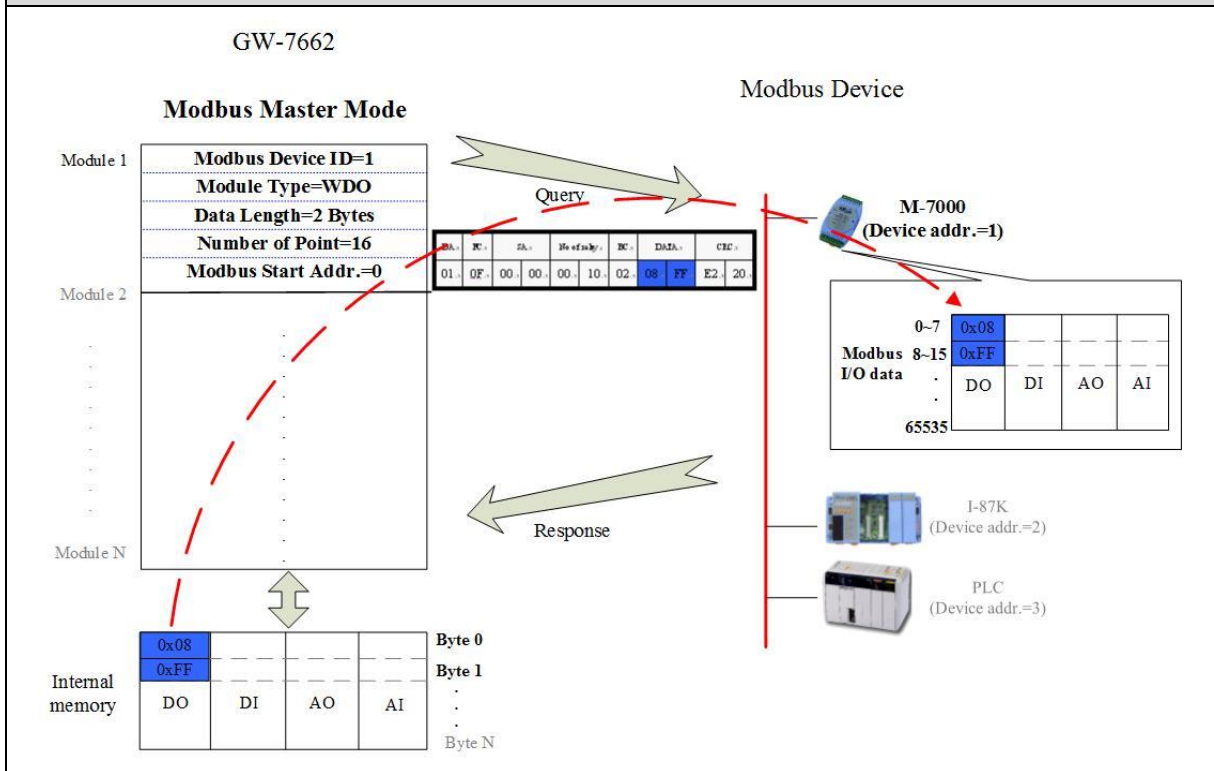

## GW-7662 receive data from Modbus slave device

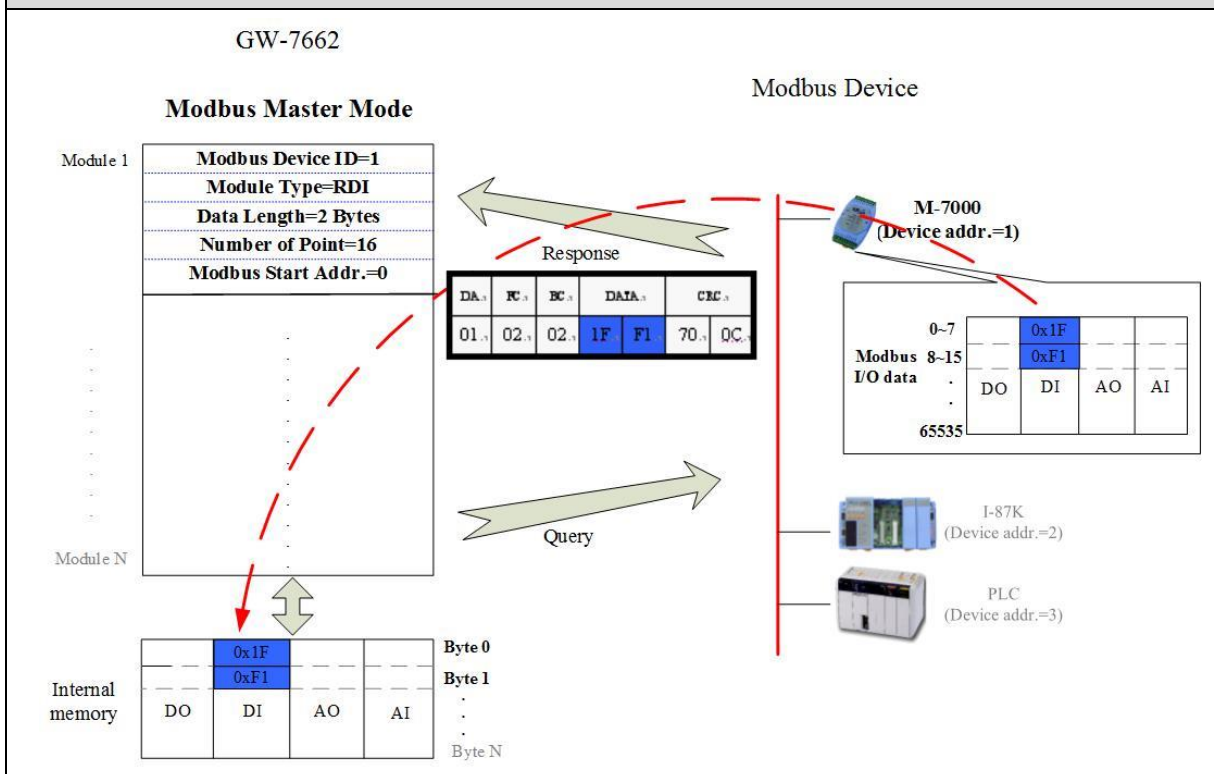

## Modbus Data Exchange – Slave mode

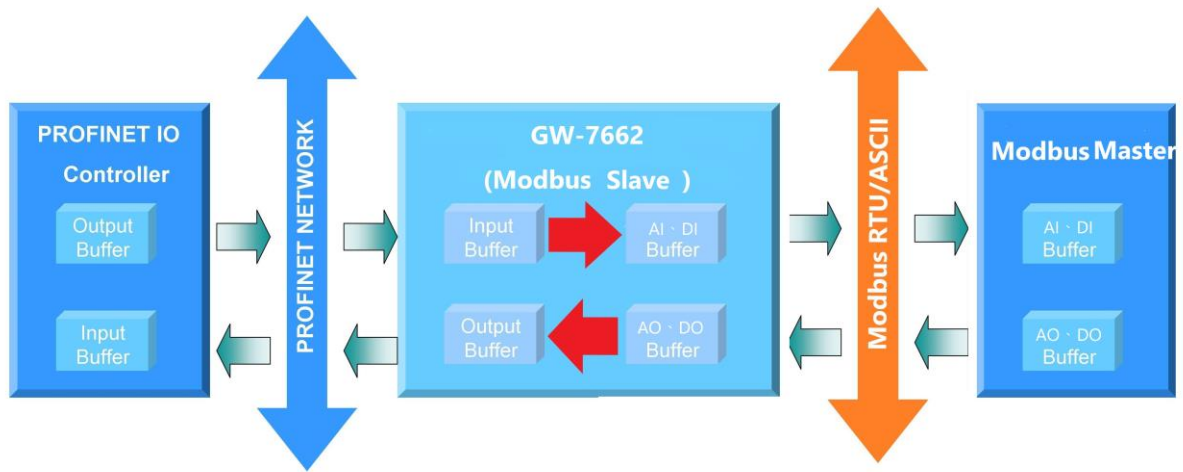

When GW-7662 acts as a Modbus slave device, it can receive query message from Modbus master device and then saving to internal DO, AO buffer. It can also send response message to Modbus master device through internal DI, AI buffer.

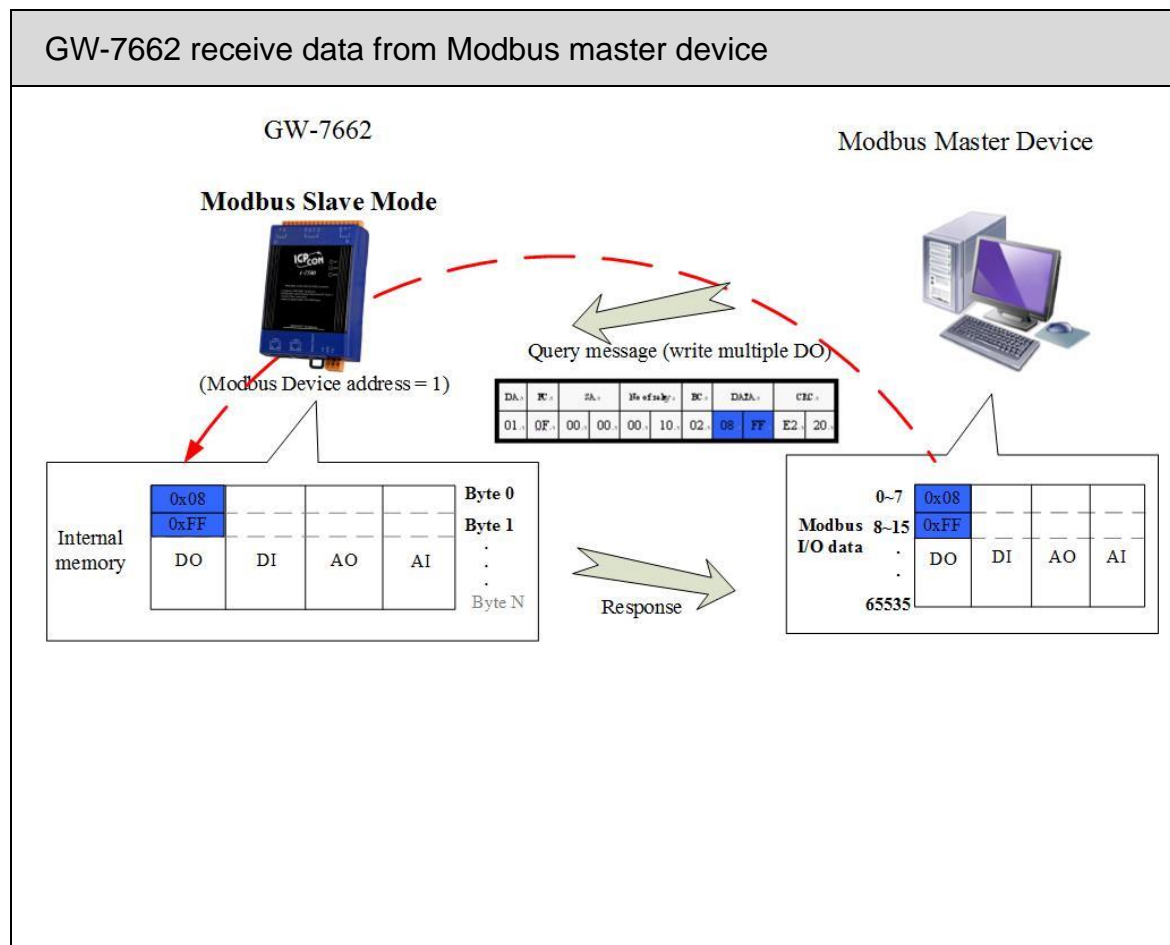

# GW-7662 output data to Modbus master device

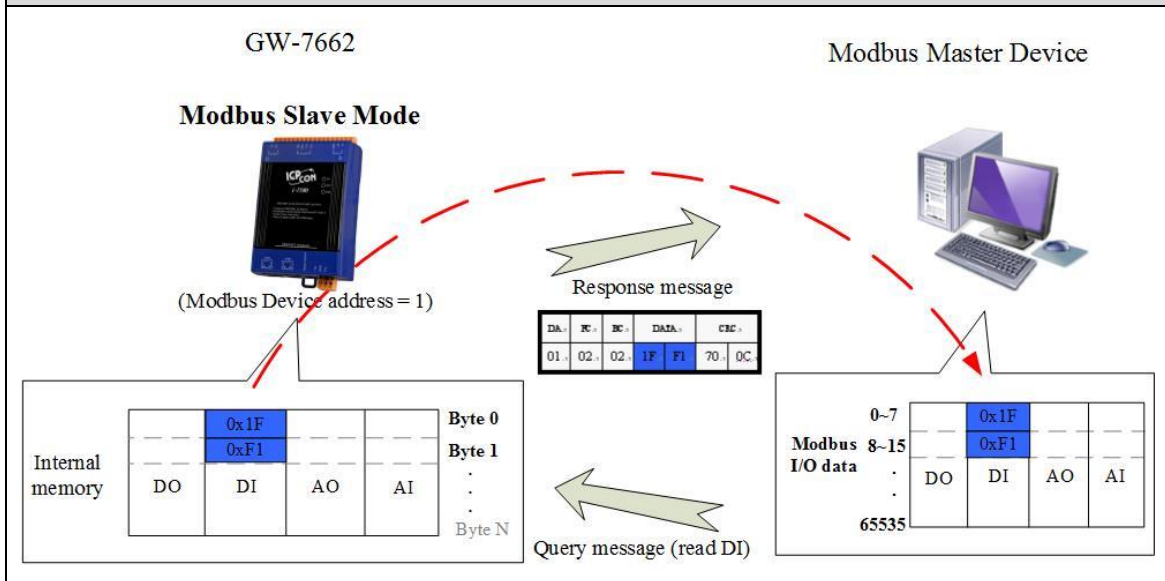



## 4.2. Module configuration

The user can set the size of the I/O modules in the PROFINET configuration tool. Each I/O module will allocate input 8 bytes and output 8 bytes for system. The settings of the modules are described below.

- Max. I/O modules: 1
- "RSW:0 Input:32Byte Output:32Byte" module
- "RSW:1 Input:64Byte Output:64Byte" module
- "RSW:2 Input:128Byte Output:128Byte" module
- "RSW:3 Input:256Byte Output:256Byte" module
- "RSW:4 Input:384Byte Output:384Byte" module
- "RSW:5 Input:512Byte Output:512Byte" module

### Tips & Warnings

---



If AP LED turn on, BOOT LED turn off and ERR LED flash slow. It means that the value of rotary switch does not match the settings of the modules (please refer to section 1.5. Overview -> Rotary Switch).

---

## 4.3. PROFINET Input Data Area

The maximum input data length of GW-7662 is 512 bytes. The first 8 bytes of the received input data are reserved for the communication status. The remaining data in the input data area represents the data packet received from the Modbus network.

Byte	Description
1	The number of diagnostic messages
2	Type of diagnostic messages
3	Description of diagnostic messages
4	Current used Modbus command module
5~8	Reserved
9~512	Received data from Modbus network

### ► Diagnostic message (byte 1~3)

---

EX: the data in byte1~3 is "0x02 0x01 0x0C". It means there are 2 diagnostic messages and the first message is "Modbus command module 1 send query message to Modbus slave device and doesn't receive any response message".

"02"	There are 2 diagnostic messages
"01"	Module 1 Error
"0C"	Response Message Timeout

### ► Received data (byte 9~512)

---

For more detail information, please refer to section 4.6.1. PLC receives DO status from Modbus master

## 4.4. PROFINET Output Data Area

The maximum output data length of GW-7662 is 512 bytes. The first 8 bytes are belong to communication commands.

Byte	Description
1	Reserved
2	Control bit
3~8	Reserved
9~512	Output data to Modbus network

### ► Control bit (byte 2)

---

Bit 0: When this bit is set, diagnostic messages send by the GW-7662 module will all be cleared.

Bit 1~7: The remaining bits have to be set to zero.

### ► Output data (byte 9~512)

---

For more detail information, please refer to section 4.6.2. PLC refreshes DI status to Modbus master.

## 4.5. Diagnostic Messages

The GW-7662 module can record maximally 32 diagnostic messages at the same time. If the number of the diagnostic messages is bigger than 32, the GW-7662 will not process other diagnostic message.

Type	Description
Module 1~128 Error (0x01~0x0D)	Illegal Function (0x01)
	Illegal Data Address (0x02)
	Illegal Data Value (0x03)
	Slave Device Failure (0x04)
	Acknowledge (0x05)
	Slave Device Busy (0x06)
	Negative Acknowledge (0x07)
	Memory Parity Error (0x08)
	Modbus Not Defined Error (0x09)
	Gateway Path Unavailable (0x0A)
	Device Failed to Respond (0x0B)
	Response Message Timeout (0x0C)
	CRC(LRC) Error (0x0D)

### ► Module Error

---

For more detail description of diagnostic message, please refer to section 9.1. Modbus Exception Code.

### Tips & Warnings

---



1. These Diagnostic messages are not supported when GW-7662 act as a Modbus slave
-

## 4.6. Data exchange example

The configuration of PROFINET, please refer to section 3.4. Project Setup. About PROFINET IO module, please select **"RSW:0 Input:32Byte Output:32Byte"**

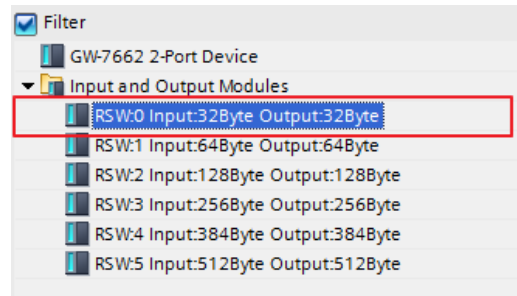

The first input 8 bytes and output 8 bytes are allocated for system. The 9th byte to the 32th byte are allocated for Modbus.

Device overview							
Module	Rack	Slot	I address	Q address	Type		
GW-7662	0	0			GW-7662 2-Port De...		G
Internal	0	0 X1			GW-7662		
RSW:0 Input:32Byte Output:32Byte_1	0	1	1...32	1...32	RSW:0 Input:32Byte...		

In the two example of 4.6.1 and 4.6.2, Modbus master simulated by PC program (MBRTU) communicate with PROFINET IO controller via GW-7662.

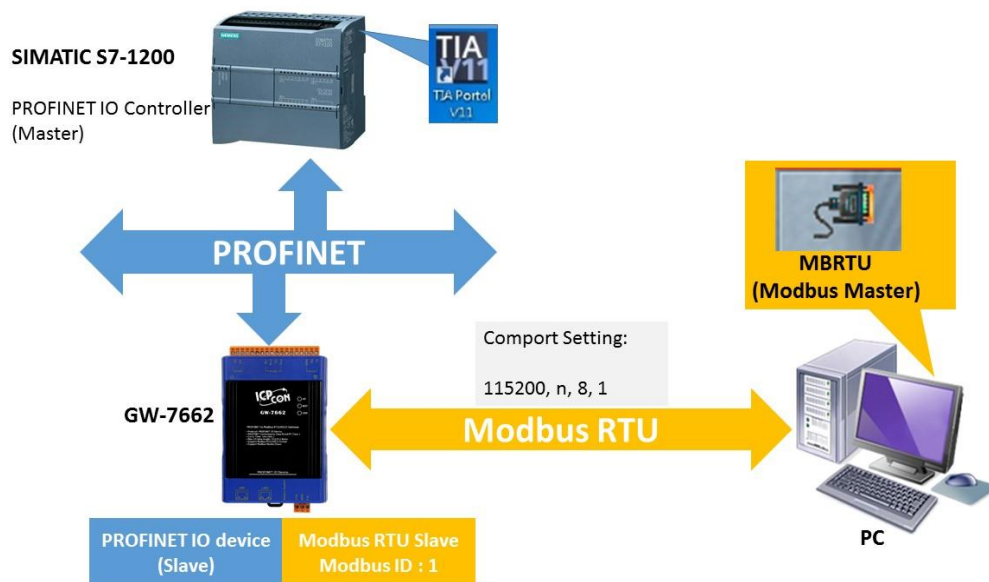

In the two example of 4.6.3 and 4.6.4, Modbus slave simulated by PC program communicate with PROFINET IO controller via GW-7662.

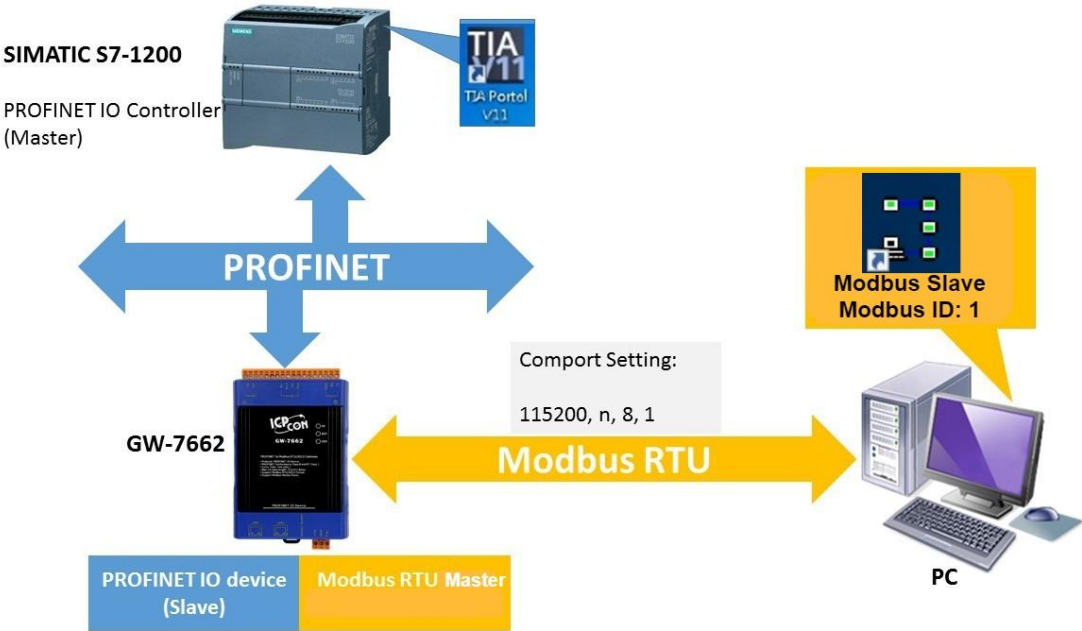

For more detail example, please refer to the following links:

- [How to communicate with Modbus RTU slave using GW-7662\(Modbus RTU master\)?](#)
- [How to communicate with Modbus RTU master using GW-7662\(Modbus RTU slave\)?](#)

## 4.6.1. PLC receives DO status from Modbus master

**Modbus Settings**

1

---

Modbus type → Slave  
 Slave Type → DO(Output Relay/Coil)  
 Count: 16 bits

Press 『Upload Settings』  
 to write settings

2

3

## Communication test

Confirm GW-7662's COM port setting is the same with Modbus master tool (ex: [MBRTU tool](#))

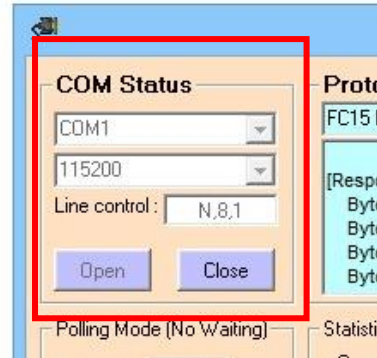

1

Send Modbus command (FC 0F) to change DO status(0xAA, 0x55)

1. Send DO Data (0xAA, 0x55)

2. Receive Resp.

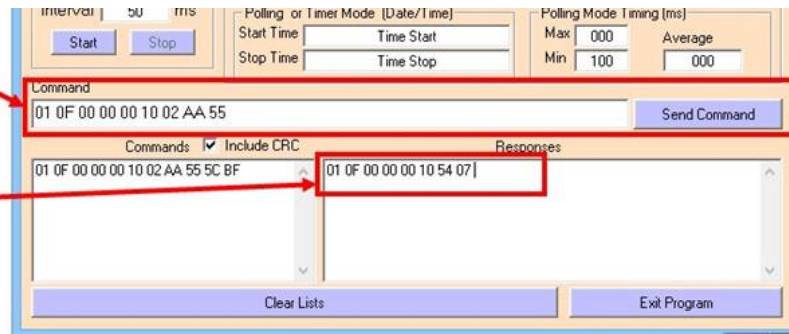

2

PLC will receive DO status(0xAA, 0x55) at PLC address IB9, IB10

	Name	Address	Display format	Monitor value
1		%IB9	Hex	16#AA
2		%IB10	Hex	16#55
3				

3



## 4.6.2. PLC refreshes DI status to Modbus master

**Modbus Settings**

1 Search Module

2 Double Click

3 Press 'Advanced Settings' button

1

Modbus type → Slave  
 Slave Type → DI (Input Relay/Coil)  
 Count: 16 bits

Press 'Upload Settings' to write settings

Parameters

Modbus Format: RTU Byte Order: Little Endian(Intel) Polling Interval (ms): 500

Modbus Type: Slave I/O Safe Mode: Last Value Query Timeout (ms): 500

Baudrate: 115200

Line Control: n, 8, 1 Modbus Device ID (dec): 1 (1~247)

Request Command

Slave Type: DI (Input Relay/Coil)

Count (dec): 16 (1~4032 Bits)

PROFINET Info.

Total Input (Byte): 8

Total Output (Byte): 10

System used: 8 Bytes

ID	FC	Mapping Table	Count	Word order	PFN Input Addr.(Byte)	PFN Output Addr.(Byte)
1	DI	10001-10016	16	No	N/A	8-9

Download Settings

Upload Settings

2

3

## Communication test

Name	Address	Display format	Monitor value	Modify value
1	%QB9	Hex	16#CD	16#CD
2	%QB10	Hex	16#EF	16#EF
3	%Add new...			

Modify QB9 to 0xCD, QB10 to 0xEF in PLC

1

Confirm GW-7662's COM port setting is the same with Modbus master tool (ex: [MBRTU tool](#))

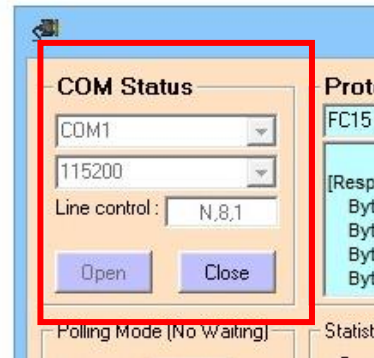

2

Send Modbus command (FC 02) to read DI status

1. Send query cmd

2. Receive DI data (0xCD, 0xEF)

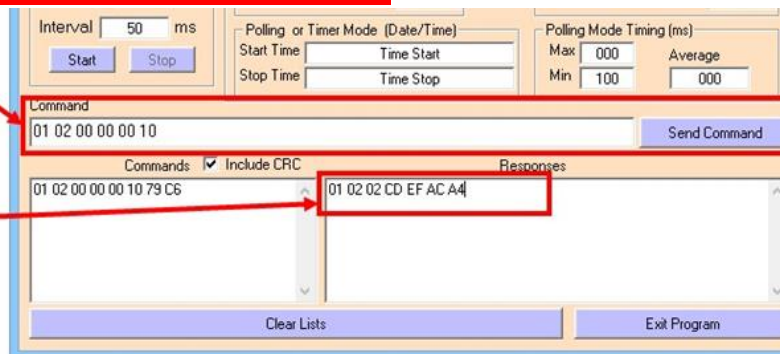

3

### 4.6.3. PLC changes DO status of Modbus slave

**Modbus Settings**

1

Modbus type→ Master  
 Function code→15(Write multiple DO)  
 Modbus ID→1  
 Start Address→0  
 Count: 16 bits

Press 『Upload Settings』  
to write settings

2

3

## Communication test

Name	Address	Display format	Monitor value	Modify value
1	%QB9	Hex	16#CD	16#CD
2	%QB10	Hex	16#EF	16#EF
3				

Modify QB9 to 0xCD, QB10 to 0xEF in PLC

1

Confirm GW-7662' s COM port setting is the same with Modbus slave tool

115200 Baud  
8 Data bits  
None Parity  
1 Stop Bit

2

Send Modbus command (FC 02) to change DO status

Communication Traffic

Exit Stop Save Copy

Mbslav1

ID = 1

```

000000 -Rx:01 0F 00 00 00 10 02 CD EF F7 3C
000001 -Tx:01 0F 00 00 00 10 54 07
    
```

00000 = 1	00008 = 1
00001 = 0	00009 = 1
00002 = 1	00010 = 1
00003 = 1	00011 = 1
00004 = 0	00012 = 0
00005 = 0	00013 = 1
00006 = 1	00014 = 1
00007 = 1	00015 = 1

PLC sends Modbus command to change DO status (0xCD,0xEF)

Modbus slave changes DO status (0xCD,0xEF)

3

## 4.6.4. PLC receives DI status from Modbus slave

**Modbus Settings**

1

---

Modbus type→ Master  
 Function code→2(Read multiple DI)  
 Modbus ID→1  
 Start Address→0  
 Count: 16 bits

Press 『Upload Settings』  
to write settings

ID	FC	Start Addr.	Count	Word order	PFN Input Addr. (Byte)	PFN Output Addr. (Byte)
1	2 (RDI)	0	16	No	8-9	N/A

2

3

## Communication test

Confirm GW-7662' s COM port setting is the same with Modbus slave tool

115200 Baud  
8 Data bits  
None Parity  
1 Stop Bit

1

Send Modbus command (FC 02) to read DI status

Mbslav1  
ID = 1

Communication Traffic

Exit Stop Save

000006-Rx: 01 02 00 00 00 10 79 C6  
000007-Tx: 01 02 02 AA 55 07 27

PLC sends Modbus command (FC 02) to read DI status

00000 = 0    00008 = 1  
00001 = 1    00009 = 0  
00002 = 0    00010 = 1  
00003 = 1    00011 = 0  
00004 = 0    00012 = 1  
00005 = 1    00013 = 0  
00006 = 0    00014 = 1  
00007 = 1    00015 = 0

DI status (0xAA,0x55)

2

PLC will receive DI status (0xAA, 0x55) at PLC address IB9, IB10

	Name	Address	Display format	Monitor value
1		%IB9	Hex	16#AA
2		%IB10	Hex	16#55
3		<Add new>		

3

## 5. MiniOS7 Utility Tool

---

The MiniOS7 Utility is a useful tool that provides a quick and easy way to get Ethernet settings and firmware version of GW-7662 module.

### 5.1. Installing the MiniOS7 Utility

#### Step 1: Get the MiniOS7 Utility tool

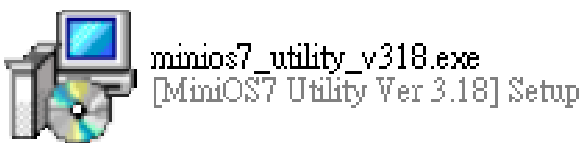

The MiniOS7 Utility can be obtained from companion CD or our FTP site:  
CD:\Napdos\minios7\utility\minios7\_utility\  
[ftp://ftp.icpdas.com/pub/cd/8000cd/napdos/minios7/utility/minios7\\_utility/](ftp://ftp.icpdas.com/pub/cd/8000cd/napdos/minios7/utility/minios7_utility/)

#### Step 2: Follow the prompts to complete the installation

After the installation has been completed, there will be a new short-cut for MiniOS7 Utility on the desktop.

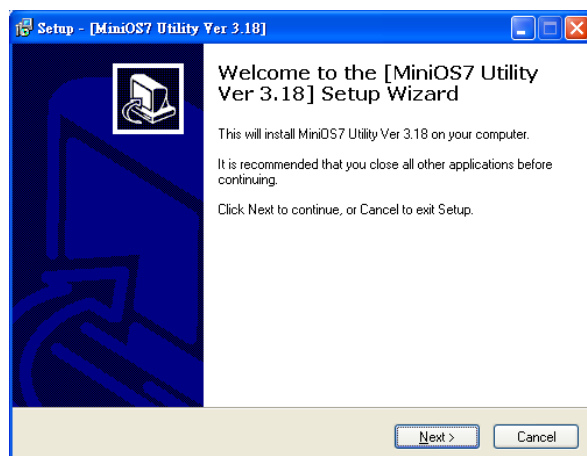

# 5.2. Using MiniOS7 Utility to get Ethernet settings and firmware version

**Step 1: Run the MiniOS7 Utility**

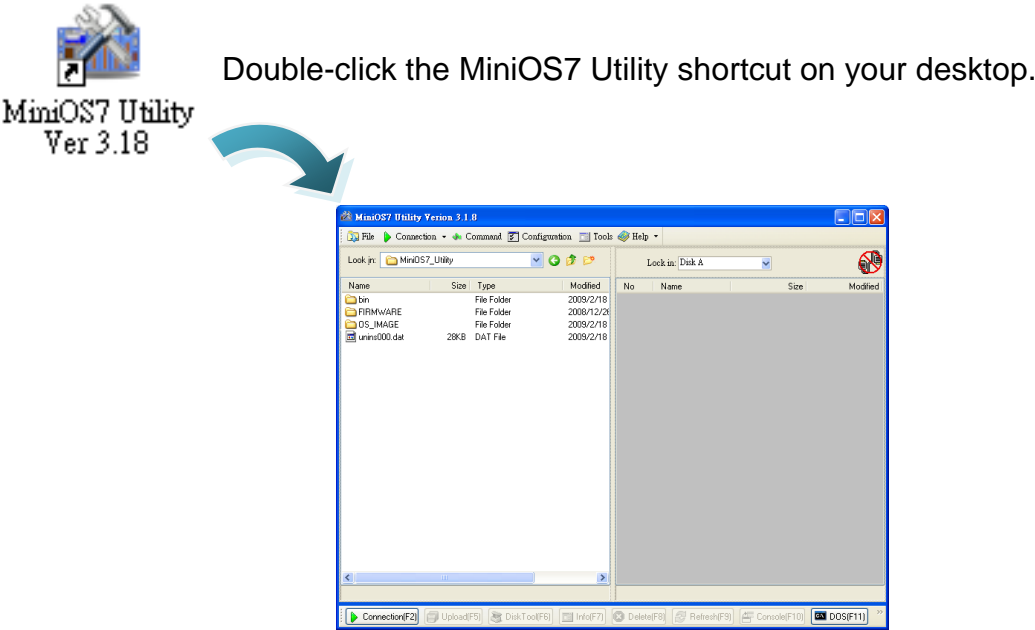

**Step 2: Press “F12” or choose “Search” from the “Connection” menu**

After pressing **F12** or choosing **Search** from **Connection** menu, that will search all of the modules that provide by ICP DAS on your network.



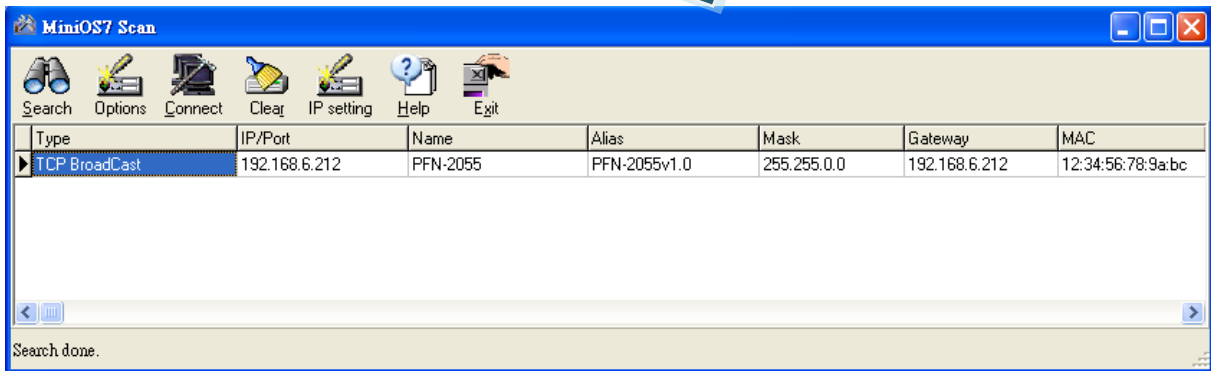
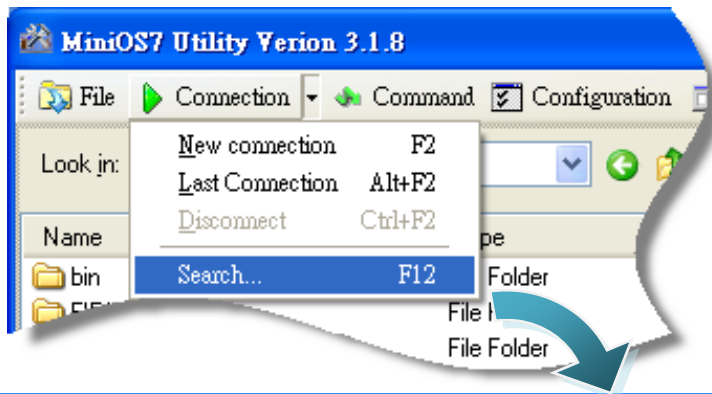

## Tips & Warnings



2. If you can't find the module by searching the network. It means the IP address of GW-7662 module is zero (default IP = 0.0.0.0). At this time, please follow the section 3.2. Network configuration=> Step 3: Set GW-7662 module's name and IP" to set module's IP and then re-search the network again. Or, wait for the PROFINET controller connect to GW-7662 module (AP LED=ON) and then re-search the network again.
3. About scan result of MiniOS7 Utility, Alias=module name & firmware version.

# 6. PFN\_Tool Utility

## 6.1. Installing the PFN\_Tool Utility

### Step 1: Get the PFN\_Tool Utility



The PFN\_Tool Utility can be obtained from companion CD or our FTP site:  
CD:\fieldbus\_cd\profinet\utility\  
[ftp://ftp.icpdas.com.tw/pub/cd/fieldbus\\_cd/profinet/utility/](ftp://ftp.icpdas.com.tw/pub/cd/fieldbus_cd/profinet/utility/)

### Step 2: Follow the prompts to complete the installation

After the installation has been completed, there will be a new shortcut for PFN\_Tool Utility on the desktop.

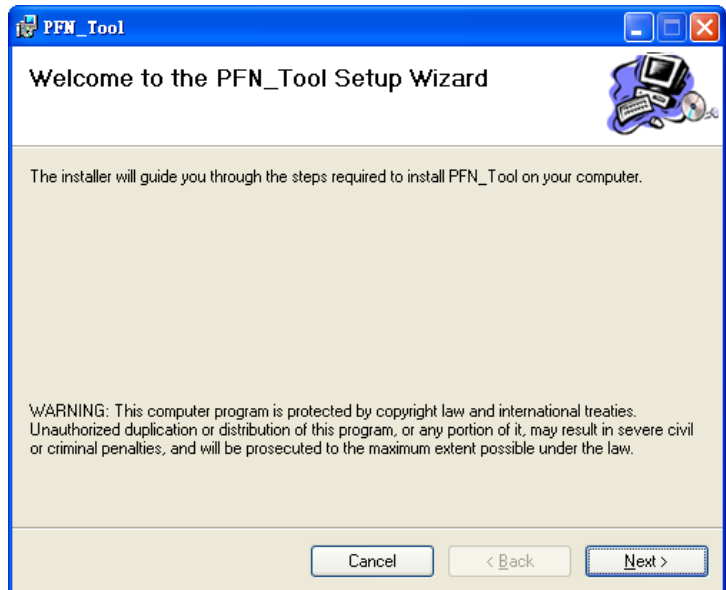

## 6.2. PFN\_Tool Utility Functionalities

### 6.2.1. Module Search

#### Step 1: Select Network Device

Select network device that connect with GW-7662 module, and press “Search Start” button.

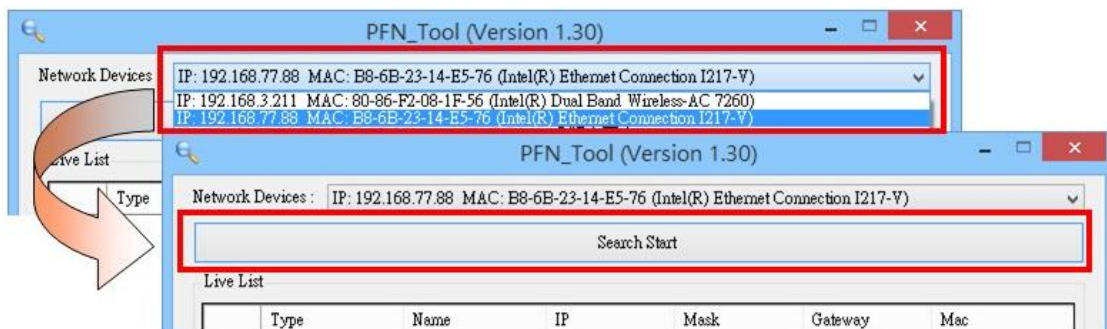

#### Step 2: Search results

Live List will show all of the PROFINET devices on the same network of network device.

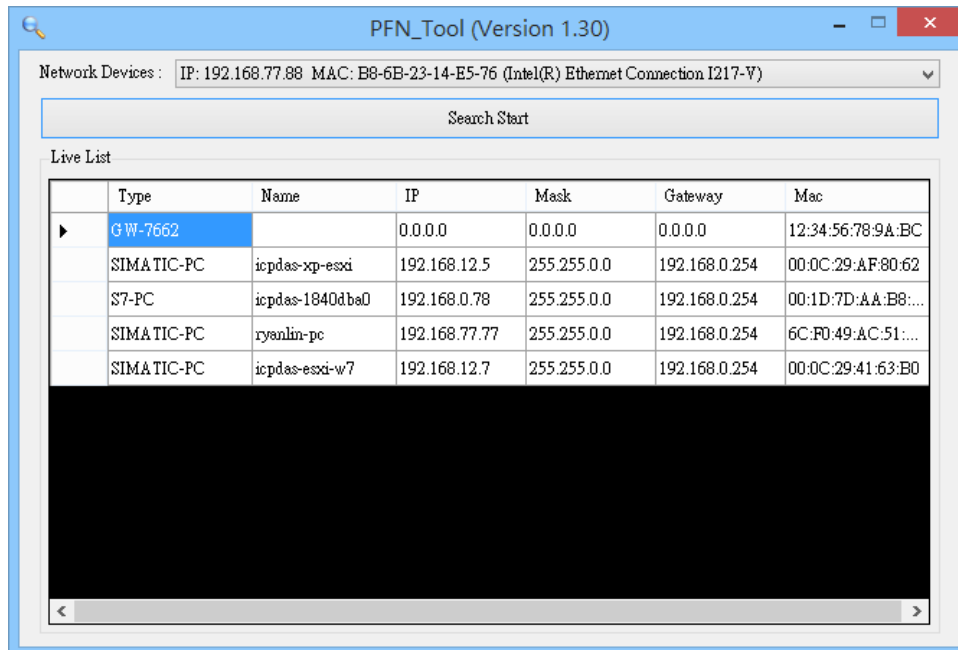

## 6.2.2. Module Basic Configuration

### Step 1: Open Device Basic Configuration

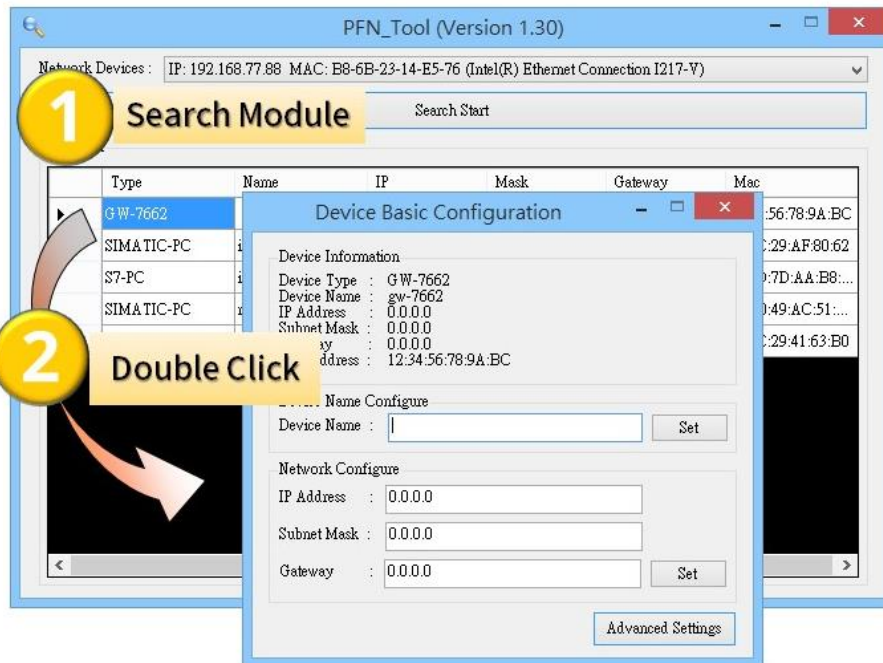

### Step 2: Set Device Name

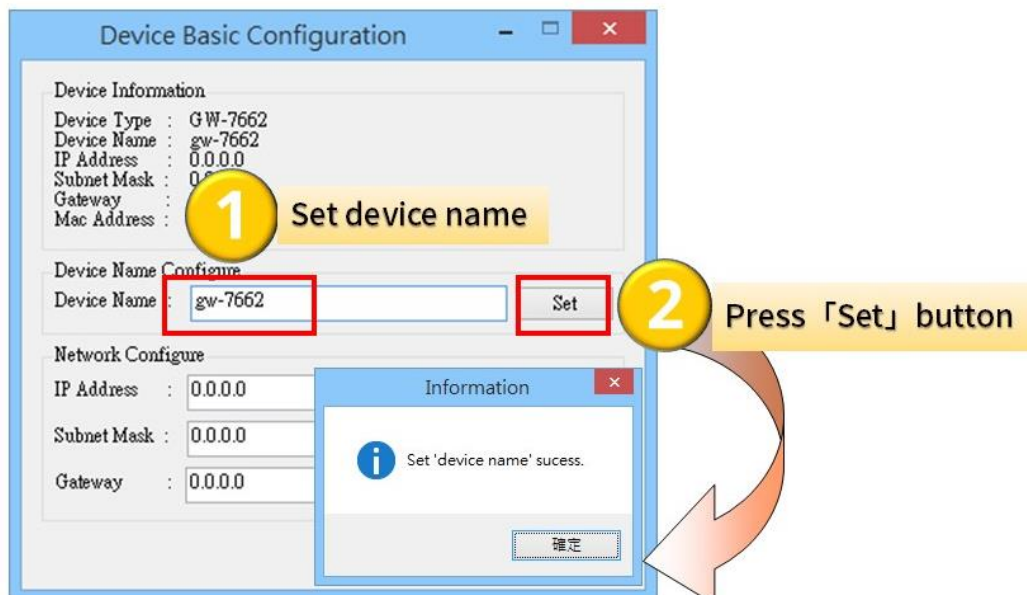

### Step 3: Set Network Parameters

The network parameter of GW-7662 module must have the same domain and different IP with PC.

EX: PC's IP = 192.168.1.110

GW-7662 module's IP = 192.168.1.111

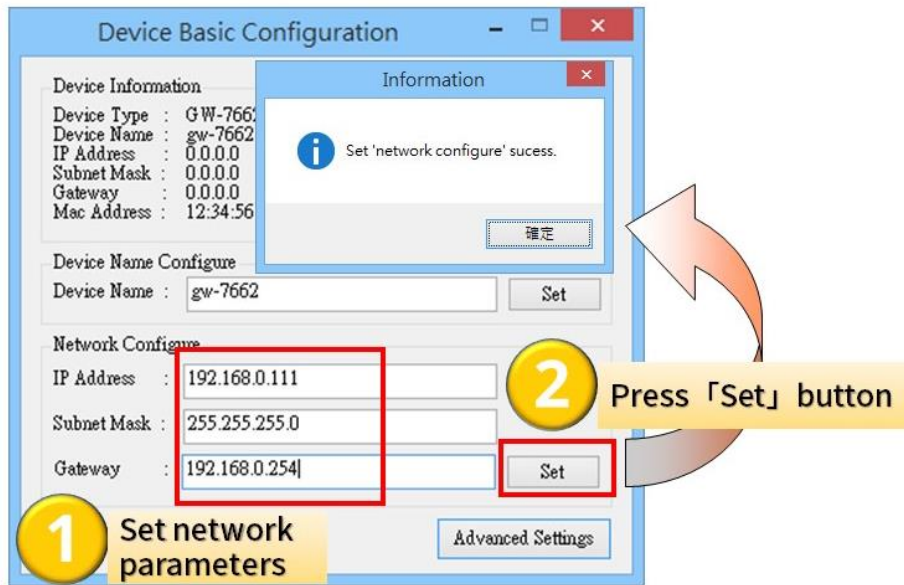

```
Connection-specific DNS Suffix . :  
Description . . . . . : Realtek RTL8168C(P)/8111C(P) PCI-E Gigabit Ethernet NIC  
Physical Address. . . . . : 6C-F0-49-AC-51-8B  
Dhcp Enabled. . . . . : No  
IP Address . . . . . : 192.168.0.110  
Subnet Mask . . . . . : 255.255.255.0  
Default Gateway . . . . . : 192.168.0.254  
DNS Servers . . . . . : 168.95.1.1
```

### Tips & Warnings



1. When PROFINET controller connect to GW-7662 module (AP LED=ON), user can't set device name and network parameters.

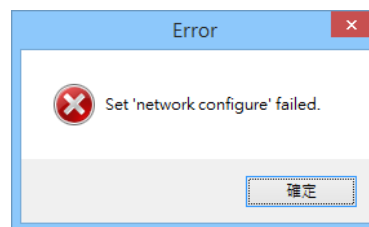
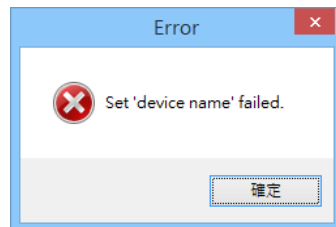

## 6.2.3. Module Advanced Configuration

### Step 1: Open Device Advanced Configuration

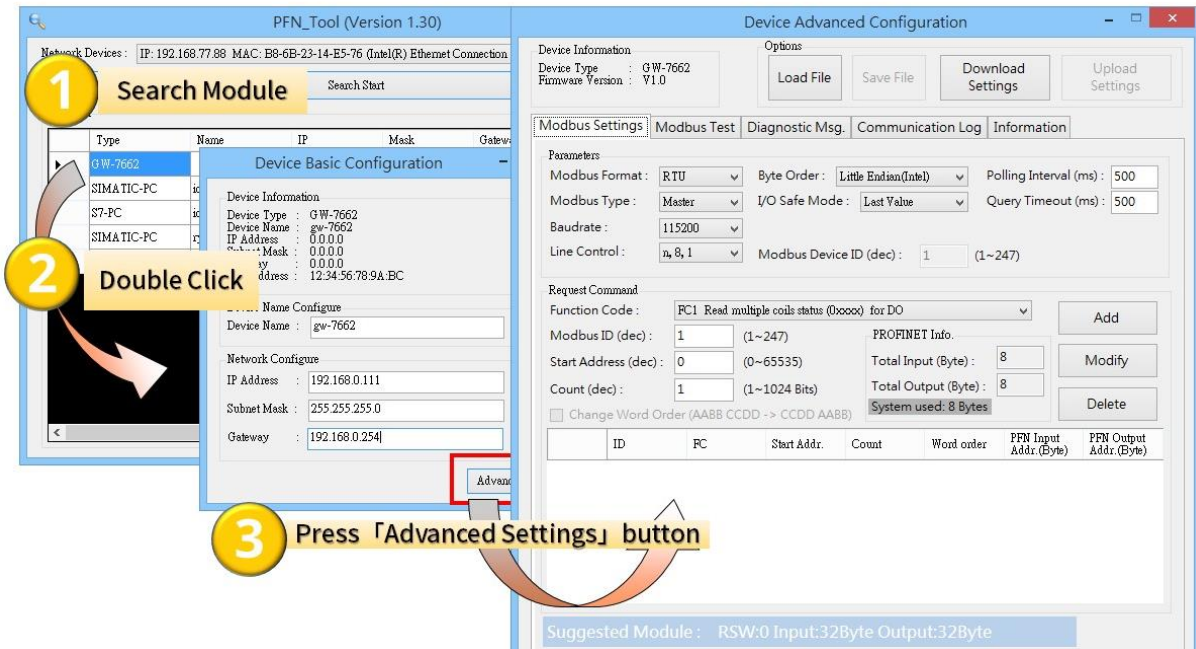

### Step 2: Advanced Configuration

Device Advanced Configuration of GW-7662 has 5 parts, they are (1)Modbus Settings (2)Modbus Test (3)Diagnostic Msg. (4)Communication Log (5)Information (6)History Diag. (utility version: V1.34 or later)

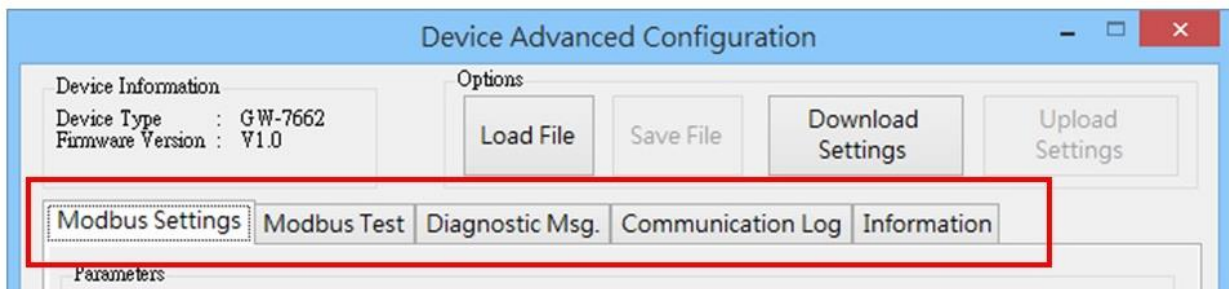

## ► Modbus Settings

Configure Modbus devices connected with GW-7662.

### Parameters

Parameters			
Modbus Format :	RTU	Byte Order :	Little Endian(Intel)
Modbus Type :	Master	I/O Safe Mode :	Last Value
Baudrate :	115200	Output Data Mode :	Auto
Line Control :	n, 8, 1	Modbus Device ID (dec) :	1 (1~247)
		Polling Interval (ms) :	500
		Query Timeout (ms) :	500

- ※ **I/O Safe Mode**: When GW-7662 acts as a Modbus master device. If connection between GW-7662 and PROFINET IO controller and Modbus slave devices is interrupted.

“*Last Value*”: Internal DO/DI/AO/AI data retain last value.

“*Safe Value*”: Internal DO/DI/AO/AI data will be set to safe value and send safe value to PROFINET IO controller and Modbus slave devices.

- ※ **Modbus Device ID**: Modbus address of the GW-7662, when GW-7662 acts as a Modbus slave device.
- ※ **Polling Interval**: Time interval between 2 Modbus commands, when GW-7662 acts as a Modbus master device.
- ※ **Query Timeout**: Timeout value for waiting Modbus response message, when GW-7662 acts as a Modbus master device.

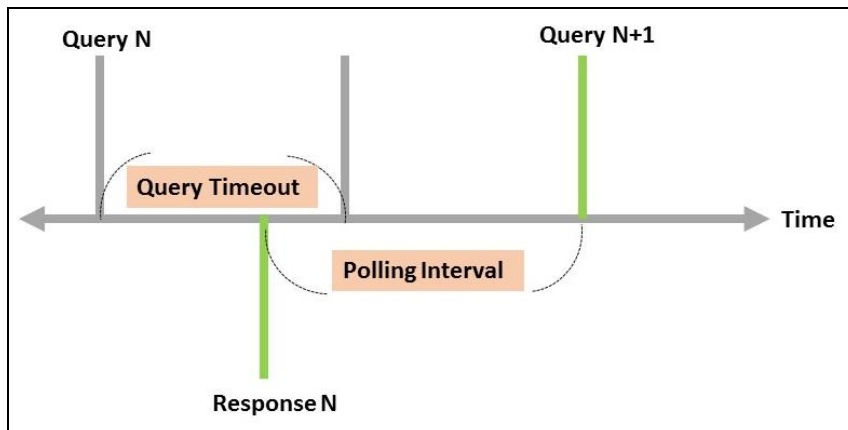

- ※ **Output Data Mode**: The method of Sending Modbus command, when GW-7662 acts as a Modbus master. (Firmware version:V1.3 or later, Utility version: V1.34 or later)
  - **Auto**: Send Modbus commands in order.
  - **Manual**: Reserved.
  - **Output Priority**: When the data of output type Modbus command change value, GW-7662 will send output type Modbus command in advance.

The example of output Priority:

Sending order	Modbus command	output data value
This command is sending	Read AI	None
1	Read DI	None
2	Read AI	None
3	Read DO	None
4	Write AO	0xABCD

Change the value of Write AO command

Sending order	Modbus command	output data value
This command is sending	Read AI	None
1	Write AO	0xABDE
2	Read DI	None
3	Read AI	None
4	Read DO	None

## Options

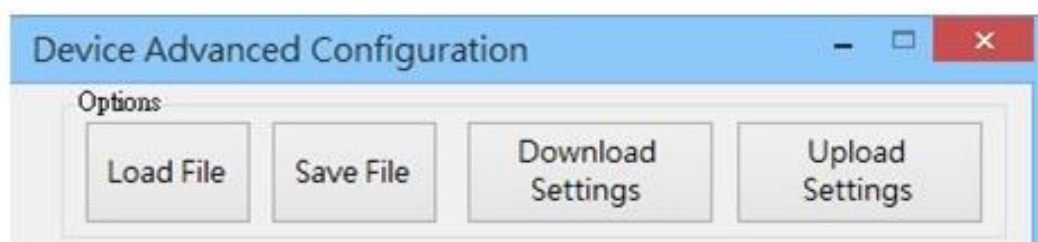

- ※ **Load File**: User can load Modbus settings from a file(\*.ini).
- ※ **Save File**: User can save Modbus settings to a file(\*.ini).
- ※ **Download Settings**: Read Modbus settings from GW-7662.
- ※ **Upload Settings**: Write Modbus settings to GW-7662, GW-7662 will reboot to complete the configuration.



## Request Command – Modbus Master

Request Command

Function Code : FC16 Write multiple registers (4x000) for AO

Modbus ID (dec) : 1 (1~247)

Start Address (dec) : 0 (0~65535)

Count (dec) : 64 (1~64 Words)

Change Word Order (AABB CCDD -> CCDD AABB)

PROFINET Info.

Total Input (Byte) : 512

Total Output (Byte) : 512

System used: 8 Bytes

Add Modify Delete

	ID	FC	Start Addr.	Count	Word order	PFN Input Addr.(Byte)	PFN Output Addr.(Byte)
▶ 1	1	16 (W&O)	0	64	No	N/A	8-135
2	1	16 (W&O)	64	64	No	N/A	136-263
3	1	16 (W&O)	128	64	No	N/A	264-391
4	1	16 (W&O)	192	60	No	N/A	392-511
5	1	4 (RAI)	0	64	No	8-135	N/A
6	1	4 (RAI)	64	64	No	136-263	N/A

Suggested Module : RSW:5 Input:512Byte Output:512Byte

- ※ **Max. Modbus command module:** 128 (Module 1~Module 128)
- ※ **Function Code:** FC01、FC02、FC03、FC04、FC05、FC06、FC15、FC16
- ※ **Modbus ID:** Device ID of Modbus slave that connected with GW-7662.
- ※ **Start Address:** GW-7662 and Modbus slave device exchange data from this starting address.
- ※ **Count:** It is data size that GW-7662 and Modbus device exchange.
- ※ **Change Word Order:** When checkbox is checked, GW-7662 will change the data between the high word and low word.
- ※ **Suggest Module:** It suggests a PROFINET IO module based on total Modbus command length.

## Request Command – Modbus Slave

Request Command

Slave Type : DO (Output Relay/Coil) Add

Count (dec) : 8 (1~8128 Bits) PROFINET Info.

Total Input (Byte) : 13 Modify

Total Output (Byte) : 18 Delete

System used: 8 Bytes

Change Word Order (AABB CCDD -> CCDD AABB)

	ID	FC	Mapping Table	Count	Word order	PFN Input Addr.(Byte)	PFN Output Addr.(Byte)
▶ 1	7	DO	00001~00008	8	No	8-8	N/A
2	7	DI	10001~10016	16	No	N/A	8-9
3	7	AO	40001~40002	2	No	9~12	N/A
4	7	AI	30001~30004	4	No	N/A	10~17

Suggested Module : RSW:0 Input:32Byte Output:32Byte

- ※ **Slave Type**: Modbus IO type when GW-7662 act as a Modbus slave.
- ※ **Count**: It is data size that GW-7662 and Modbus device exchange.
- ※ **Change Word Order**: When checkbox is checked, GW-7662 will change the data between the high word and low word.
- ※ **Suggest Module**: It suggests a PROFINET IO module based on total Modbus command length.

## ► Modbus Test

User can test communication between GW-7662 and Modbus devices.

**1** Configure Modbus Settings

**2** Move to Modbus Test page and press 「Upload Settings」 button

**3** 1. Set output value  
2. Press 「Send Data」 to change output value

**4** It will auto update input value

The screenshots show the following data in the Command List table:

ID	FC	Start Addr.	Count	Word order	FFN Input Addr. (Byte)	FFN Output Addr. (Byte)
1	15 (WDO)	0	16	No	N/A	8-9
2	4 (RAI)	0	2	No	8-11	N/A

The Command Test section shows the following data:

Byte	b7	b6	b5	b4	b3	b2	b1	b0	Value (Hex)
Byte 1	0	1	0	1	0	1	0	1	55
Byte 2	1	0	1	0	1	0	1	0	AA

The Command Test section also shows the following data:

Word	Value (Hex)
Word 1	5566
Word 2	7788

## ► Diagnostic Msg.

It shows diagnostic messages of GW-7662.

**Step 1:** Press 「Update」 button to update diag. msg

**Step 2:** Diag. Msg. Count : 1

**Step 3:** Diag. Msgs.

Diag Data	Type	Message
0x01 0x0C	Module 1 Error	Response Message Timeout

Name	Address	Display format	Monitor value	Modify value	Comment
1	%IB1	Hex	16#01	<input type="checkbox"/>	
2	%IB2	Hex	16#01	<input type="checkbox"/>	
3	%IB3	Hex	16#0C	<input type="checkbox"/>	
4	<Add new>				

## ► Communication Log

It shows communication logs between GW-7662 and Modbus devices connected with GW-7662.

**1**

Press 「 Update 」 button to update log

**2**

Update OK

**3**

2. Press 「 Save 」 button to Save logs

1. Save ok

#	Tiemaasp(ms)	Type	Tx/Rx	Frame
1	3314747	WDO	Tx	01 0F 00 00 00 10 02 EB 4D 6C E5
2	3314783	WDO	Rx	01 0F 00 00 00 10 54 07
3	3315287	RAI	Tx	01 04 00 00 00 02 71 CB
4	3315323	RAI	Rx	01 04 04 EB A5 0B A5 19 08
5	3315827	WDO	Tx	01 0F 00 00 00 10 02 ED 66 2F 5A
6	3315863	WDO	Rx	01 0F 00 00 00 10 54 07
7	3316367	RAI	Tx	01 04 00 00 00 02 71 CB
8	3316397	RAI	Rx	01 04 04 EB A7 0B A7 39 09
9	3316903	WDO	Tx	01 0F 00 00 00 10 02 EF 7E 2E 30
10	3316937	WDO	Rx	01 0F 00 00 00 10 54 07
11	3317443	RAI	Tx	01 04 00 00 00 02 71 CB
12	3317477	RAI	Rx	01 04 04 EB A9 0B A9 D9 0E
13	3317983	WDO	Tx	01 0F 00 00 00 10 02 F1 98 A6 1A
14	3318085	WDO	Rx	01 0F 00 00 00 10 54 07
15	3318591	RAI	Tx	01 04 00 00 00 02 71 CB

► **Information**

It shows PROFINET settings of GW-7662.

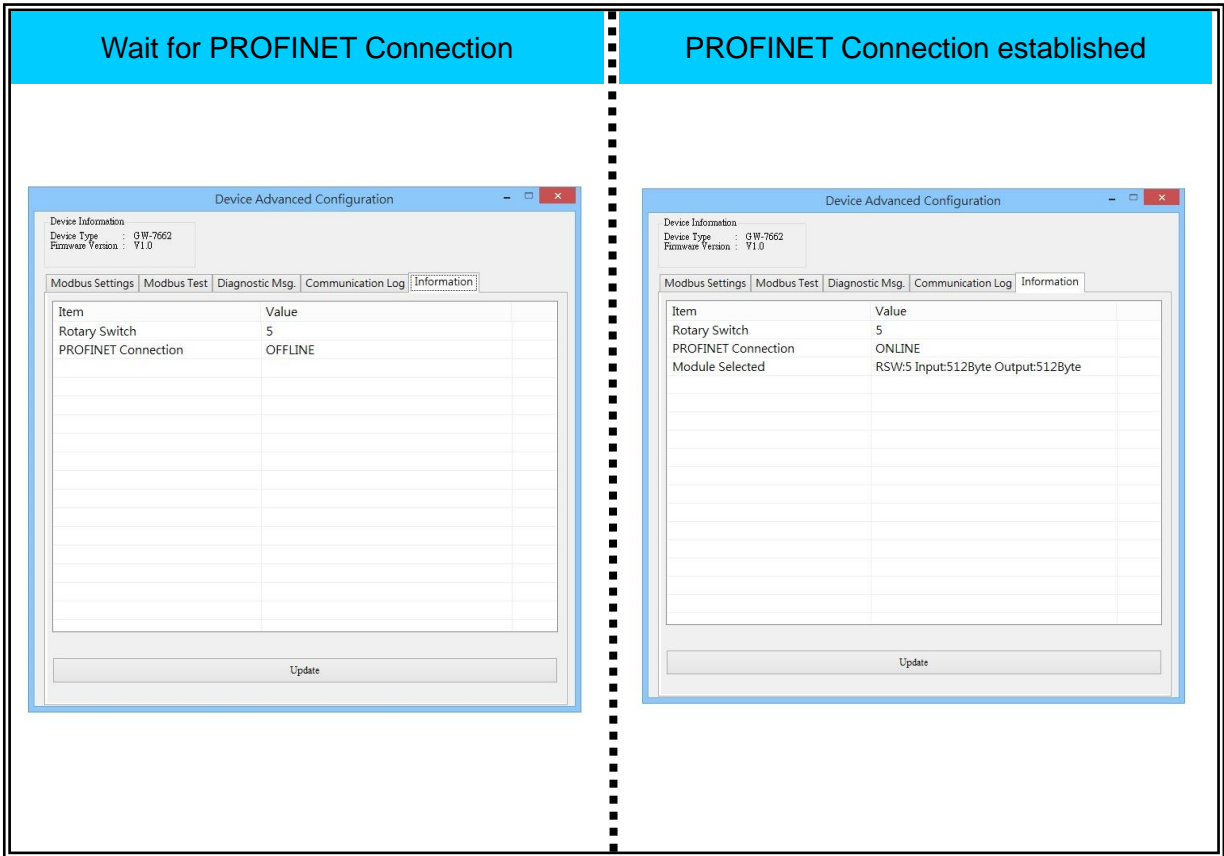

► History Diag.

(Firmware version: V1.3 or later, utility version: v1.34 or later)

- It shows history diagnostic messages of GW-7662.
- History diagnostic message: GW-7662 has shown the diagnostic messages, whatever the error is resolved.

Diag. Msg. Count : 5

Diag Data	Type	Message
0x01 0x0C	Module 1 Error	Response Message Timeout
0x02 0x0C	Module 2 Error	Response Message Timeout
0x03 0x0C	Module 3 Error	Response Message Timeout
0x04 0x0C	Module 4 Error	Response Message Timeout
0x05 0x0C	Module 5 Error	Response Message Timeout

Diag. Msgs.

Press 「Update」 button to update history diag. msg

1

2

# 7. Configuration with Web Browser

---

## 7.1. Connecting to Web Server

Open web browser (ex. IE) and enter the IP address of the GW-7662 module in the Address field and press “Enter” to connect to GW-7662 module.

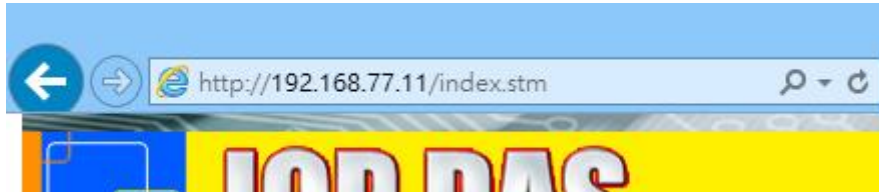

### Tips & Warnings

---



1. GW-7662 has to set IP settings to connect to web server. Please follow the section **3.2. Network configuration=> Step 3: Set GW-7662 module's name and IP"** to set module's IP or follow the section **5.2. Using MiniOS7 Utility to get Ethernet settings and firmware version** or follow the section **6.2.2. Module Basic Configuration**.



## 7.2. Web Configuration



The left side(1) is the function menu and the other(2) is the setup page.

Function Menu:

- Home
- Modbus Settings
- Communication Logs
- Diagnostic Messages
- Information

### ► Home

It shows the introduction of GW-7662.

## ► Modbus Settings

---

It shows Modbus settings stored in GW-7662.

Modbus Settings							
Parameters							
Modbus Format	RTU	Byte Order	Little Endian(intel)	Polling Interval (ms)	500		
Modbus Type	Master	I/O Safe Mode	Last Value	Query Timeout (ms)	500		
Baudrate	115200						
Line Control	n, 8, 1	Modbus Device ID (dec)	N/A				
Request Command							
#	ID	FC	Start Addr.	Count	Word order	PFN Input Addr. (Byte)	PFN Output Addr. (Byte)
1	1	15 (WDO)	0	16	No	N/A	8~9
2	1	4 (RAI)	0	2	No	8~11	N/A

## ► Communication Logs

It shows communication logs between GW-7662 and Modbus devices connected with GW-7662.

**Communication Log**

---

**Modbus RTU Master**

#	Timestamp (ms)	Type	Tx/Rx	Frame
1	506203	WDO	Tx	01 0F 00 00 00 10 02 41 C7 93 E2
2	506231	WDO	Rx	01 0F 00 00 00 10 54 07
3	506735	RAI	Tx	01 04 00 00 00 02 71 CB
4	506767	RAI	Rx	01 04 04 22 FC 42 FC 01 2D
5	507273	WDO	Tx	01 0F 00 00 00 10 02 43 DC D2 89
6	507311	WDO	Rx	01 0F 00 00 00 10 54 07
7	507815	RAI	Tx	01 04 00 00 00 02 71 CB
8	507851	RAI	Rx	01 04 04 22 FE 42 FE 21 2C
9	508357	WDO	Tx	01 0F 00 00 00 10 02 45 F9 10 F2
10	508393	WDO	Rx	01 0F 00 00 00 10 54 07
11	508895	RAI	Tx	01 04 00 00 00 02 71 CB
12	508931	RAI	Rx	01 04 04 23 00 43 00 C1 30
13	509437	WDO	Tx	01 0F 00 00 00 10 02 48 12 54 2D
14	509475	WDO	Rx	01 0F 00 00 00 10 54 07
15	509983	RAI	Tx	01 04 00 00 00 02 71 CB
16	510085	RAI	Rx	01 04 04 23 02 43 02 E1 31
17	510731	WDO	Tx	01 0F 00 00 00 10 02 4A 94 D4 EF
18	510763	WDO	Rx	01 0F 00 00 00 10 54 07
19	511397	RAI	Tx	01 04 00 00 00 02 71 CB
20	511565	RAI	Rx	01 04 04 23 05 43 05 11 32

Press 「 Update 」 to update logs

## ► Diagnostic Messages

- It will show diagnostic messages of GW-7662.
- History diagnostic message: GW-7662 has shown the diagnostic messages, whatever the error is resolved. (Firmware version: V1.3 or later)

1

---

2

Diag Data	Type	Messages
0x1 0xC	Moddule 1 Error	Response Message Timeout
0x2 0xC	Moddule 2 Error	Response Message Timeout

Name	Address	Display format	Monitor value	Modify
	%IB1	Hex	16#02	
	%IB2	Hex	16#01	
	%IB3	Hex	16#0C	
	<Add new>			

(Firmware version: V1.3 or later)

**Diagnostic Message Descriptions**

Message Counts: 2

Diag Data	Type	Messages
0x04 0x0C	Module 4 Error	Response Message Timeout
0x05 0x0C	Module 5 Error	Response Message Timeout

**History Diagnostic Message Descriptions**

Message Counts: 5 ← History Diag. Msg. Count : 5

Diag Data	Type	Messages
0x01 0x0C	Module 1 Error	Response Message Timeout
0x02 0x0C	Module 2 Error	Response Message Timeout
0x03 0x0C	Module 3 Error	Response Message Timeout
0x04 0x0C	Module 4 Error	Response Message Timeout
0x05 0x0C	Module 5 Error	Response Message Timeout

← History Diagnostic Messages

3

## ► Information

It shows PROFINET settings of GW-7662.

Device Information		Module Information	
<b>Device Information</b>		<b>Module Information</b>	
<b>HARDWARE:</b>			
MAC Address:	12:34:56:78:9a:bc	Rotary Switch:	5
Device Hardware Revision:	1	PROFINET Connection:	ONLINE
<b>NETWORK INTERFACE FIRMWARE:</b>			
Industrial Ethernet Protocol:	PROFINET	Module Selected:	RSW:5 Input:512Byte Output:512Byte
Firmware Version:	3.3		
<b>SOFTWARE:</b>			
User Software Version:	1.0.0		
<b>IP STATUS:</b>			
IP address:	192.168.77.11		
Subnet mask:	255.255.0.0		
Gateway:	192.168.0.254		

## 8. Troubleshooting

Item	Trouble state	Solution
1	'AP', 'BOOT' and 'ERR' LED are always off.	The power supply of GW-7662 module has some problems. Please check the wire connection of the power and the voltage is between 10~30V <sub>DC</sub> .
2	'AP' and 'BOOT' LED are always off and 'ERR' LED is always flash per 500ms.	That means the GW-7662 module can't connect to the PROFINET IO controller. Please check the wire connection and module configuration (include network settings, device name) and project configuration of engineering tool that provide by PROFINET IO controller's manufacturer.
3	'AP' LED is always on and 'BOOT' LED is always off and 'ERR' LED is always flash per 500ms.	It means that the value of rotary switch does not match the settings of the modules (please refer to section 4.2. Module configuration).
4	'BOOT' LED is always on.	It means the GW-7662 module is at Bootloader mode. Please switch to AP mode(section 1.5. Overview→Rotary Switch).
5	Can't find any GW-7662 module by MiniOS7 Utility	It means the IP address of GW-7662 module is zero (default IP = 0.0.0.0). At this time, please follow the section 3.2. Network configuration => Step 3: Set GW-7662 module's name and IP" to set module's IP and then re-search the network again. Or, wait for the PROFINET controller connect to GW-7662 module (AP LED=ON) and then re-search the network again.
6	Can't find any GW-7662 module by PFN_Tool Utility	<ol style="list-style-type: none"> <li>Please check the wire connection</li> <li>Please set the GW-7662 module to AP mode, please refer to the section 1.5. → Rotary Switch.</li> <li>Please check network card is ok, and GW-7662 module and network card have to in the same network.</li> </ol>

# 9. Appendix

---

## 9.1. Modbus Exception Code

Code	Name	Meaning
01	Illegal Function	The Function Code received in the query is not an allowable action for the server (or slave). This may be because the function code is only applicable to newer devices, and was not implemented in the unit selected. It could also indicate that the server (or slave) is in the wrong state to process a request of this type, for example because it is not configured and is being asked to return register values.
02	Illegal Data Address	The data address received in the query is not an allowable address for the server (or slave). More specifically, the combination of reference number and transfer length is invalid. For a controller with 100 registers a request of offset 96 and a length of 5 will generate exception 02.
03	Illegal Data Value	A value contained in the query data field is not an allowable value for server (or slave). This indicates a fault in the structure of the remainder of a complex request, such as that the implied length is incorrect. It specifically does NOT mean that a data item submitted for storage in a register has a value outside the expectation of the application program, since the MODBUS protocol is unaware of the significance of any particular value of any particular register.
04	Failure In Associated Device	An unrecoverable error occurred while the server (or slave) was attempting to perform the requested action.
05	Acknowledge	Specialized use in conjunction with programming commands. The server (or slave) has accepted the request and is processing it, but a long duration of time will be required to do so. This response is returned to prevent a timeout error from occurring in the client (or master). The client (or master) can next issue a Poll Program Complete message to determine if processing is completed.



06	Busy, Rejected Message	Specialized use in conjunction with programming commands. The server (or slave) is engaged in processing a long-duration program command. The client (or master) should retransmit the message later when the server (or slave) is free.
07	Negative Acknowledgement	The program function just requested cannot be performed. Issue poll to obtain detailed device dependent error information. Valid for Program/Poll 13 and 14 only.
08	Memory Parity Error	Specialized use in conjunction with function codes 20 and 21 and reference type 6, to indicate that the extended file area failed to pass a consistency check. The server (or slave) attempted to read record file, but detected a parity error in the memory. The client (or master) can retry the request, but service may be required on the server (or slave) device.
0A	Gateway Path Unavailable	Specialized use in conjunction with gateways, indicates that the gateway was unable to allocate an internal communication path from the input port to the output port for processing the request. Usually means that the gateway is misconfigured or overloaded.
0B	Gateway Target Device Failed to respond	Specialized use in conjunction with gateways, indicates that no response was obtained from the target device. Usually means that the device is not present on the network.