I-7547

Ethernet To HART Converter

User's Manual

Warranty

All products manufactured by ICP DAS are under warranty regarding defective materials for a period of one year from the date of delivery to the original purchaser.

Warning

ICP DAS assumes no liability for damages resulting from the use of this product. ICP DAS reserves the right to change this manual at any time without notice. The information furnished by ICP DAS is believed to be accurate and reliable. However, no responsibility is assumed by ICP DAS for its use, or for any infringements of patents or other rights of third parties resulting from its use.

Copyright

Copyright 2013 by ICP DAS. All rights are reserved.

Trademark

The names used for identification only may be registered trademarks of their respective companies.

Table of Contents

1. Introduction	4
1.1 Features	4
1.2 Specifications	5
2. Hardware	7
2.1 Pin Assignment of I-7547	8
2.1.1 Pin Function Description	8
2.1.2 HART Wiring	9
2.2 Terminator Resistor Settings	12
2.3 Init / Normal Dip-switch	13
2.3.1 Firmware Update Mode	14
2.3.2 Firmware Operation Mode	16
2.4 LED Indication	16
2.4.1 LED Function	16
2.4.2 LED Indication Table	17
2.5 Cable Selection	17
3. Web Server Configuration	18
3.1 Connect to I-7547 Web Server	18
3.2 Home	19
3.3 Network Setting	19
3.4 Monitor	22
3.5 Change Password	23
3.6 Logout	23
3.7 Port1 / Port2 Settings (Support Pair-Connection)	23
4. HC_Tool Utility	26
4.1 VxComm Utility	26
4.2 Run HC_Tool	28
4.3 Serial Port and HART Command Settings	29
4.3.1 Serial port settings	29
4.3.2 HART Frame Settings	29
4.4 Search HART devices	30
4.4.1 Search HART devices automatically	30
4.4.2 Search HART devices manually	31
4.4.3 Search HART devices	32
4.5 Send / Receive HART Frame (SRMsg)	34
4.6 HART Information Log (Data Log)	35
4.7 HART Configuration (HTCfg)	36

4.8	Module Configuration (ModCfg)	38
5.	FAQ	41
	Q01 : How to use I-7547 to communicate with HART devices ?.....	41
	Q02 : Does I-7547 support the Pair-Connection for HART ?	41
	Q03 : Does I-7547 support HART OPC Server from HCF?	41
	Q04 : Set HART device address by using HART converter ?	41
	Q05 :How to send HART command for writing (Ex: CMD51)?.....	43
	Q06: How to connect with HART OPC server?.....	45
	Q07 : How to connect with HART FDT software?	48
	Q08 : How to listen HART network communication by HART converter	57
	Q101 : How to get the current IP address of I-7547 ?.....	60
	Q102 : How to avoid I-7547 to reset automatically ?	60
	Q103 : How to write Ethernet program to access HART device data via I-7547 ..	61
6.	Version History.....	62

1. Introduction

I-7547 is an Ethernet to HART converter designed as the master device of HART protocol. It allows users to access the HART slaves via Ethernet by using virtual COM port. These HART slave devices may be a transmitter, actuator, current output device, and so forth. I-7547 provides four HART channels and 250 Ω load built-in resistors for each HART channel which are adjustable by jumpers. In addition, we also provide free utility tool (HC_Tool) for users to configure I-7547 and test HART communication easily and quickly.

The following is the application structure of I-7547.

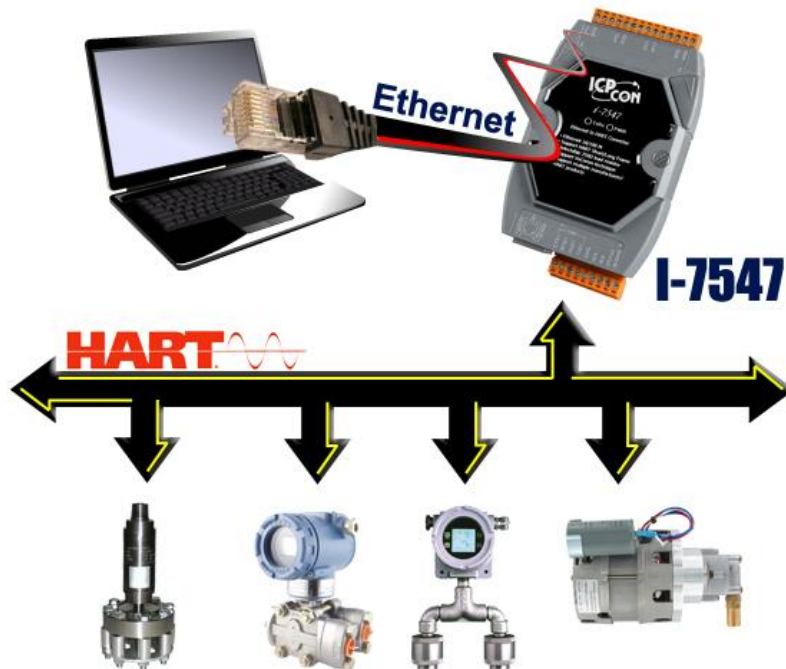

1.1 Features

- Support HART Short / Long frame.
- Support HART Burst mode.
- Support point-to-point or multi-drop HART mode.
- Support connecting up to 15 HART slave devices.
- Allow two HART masters.
- Provide utility tool for module configuration and HART communication.

- Provide four HART channels.
- Support firmware update via Ethernet
- Provide PWR / TxRx indication LED
- 4KV ESD Protection
- Built-in Watchdog
- Selectable 250Ω load resistor for each HART channel.
- Support FDT (Field Device Tool) technology (like: PACTware / FieldCare / Seimens PDM ...)
- Support HART Pair-Connection (FW_v1.03)

1.2 Specifications

[Ethernet Spec.]

Ethernet Port	10/100 Base-TX with Auto MDI/MDI-X
Virtual COM	Created by VxComm Utility
Built-In Web Server	Ethernet Parameters Configuration

[HART Spec.]

Channel	4
Connector	2-pin screwed terminal block (for each HART Ch.)
Device type	Two-wiring or four-wiring HART devices
Network	Point to Point or Multi-drop
Comm. Mode	Only HART digital communication
Frame	Short or Long frame
Burst Mode	Support
Max. Device	15 HART slave devices
Load Resistor	Selectable 250Ω by Jumper (for each HART Ch.)
Isolation	500 VDC
Operate Mode	HART Master and supports all HART commands

[COM Spec.]

COM1	Tx / Rx / GND / RTS / CTS
Baud Rate (bps)	1200 ~ 115200bps
Data Format	N/O/E (parity), 5/6/7/8 (data bit), 1/2 (stop bit)

[Power Requirement]

Power supply	Unregulated +10 ~ +30 VDC
Protection	Power reverse protection, Over-Voltage brown-out protection
Power Consumption	1.5W

[Module spec.]

Dimensions	123mm x 72mm x 35mm (H x W x D)
Operating temperature	-25 ~ +75 °C (-13 to 167 °F)
Storage temperature	-30 ~ +80 °C (-22 to 176 °F)
Humidity	5% ~ 95% RH, non-condensing
LED	PWR : Power Indicator TxRx : Data Received from Ethernet / HART Indicator

[Utility Tool]

- Provide module configuration and HART communication easily and quickly.
- Provide automatically searching function for HART devices.
- Provide diagnostic Information of HART device.
- Provide data logging for HART communication.

[Application]

- Current Measuring.
- Petrochemical Industry Application.
- Environment Monitoring.
- Tunnel Monitoring.
- Monitor system.
- Building Monitoring.

2. Hardware

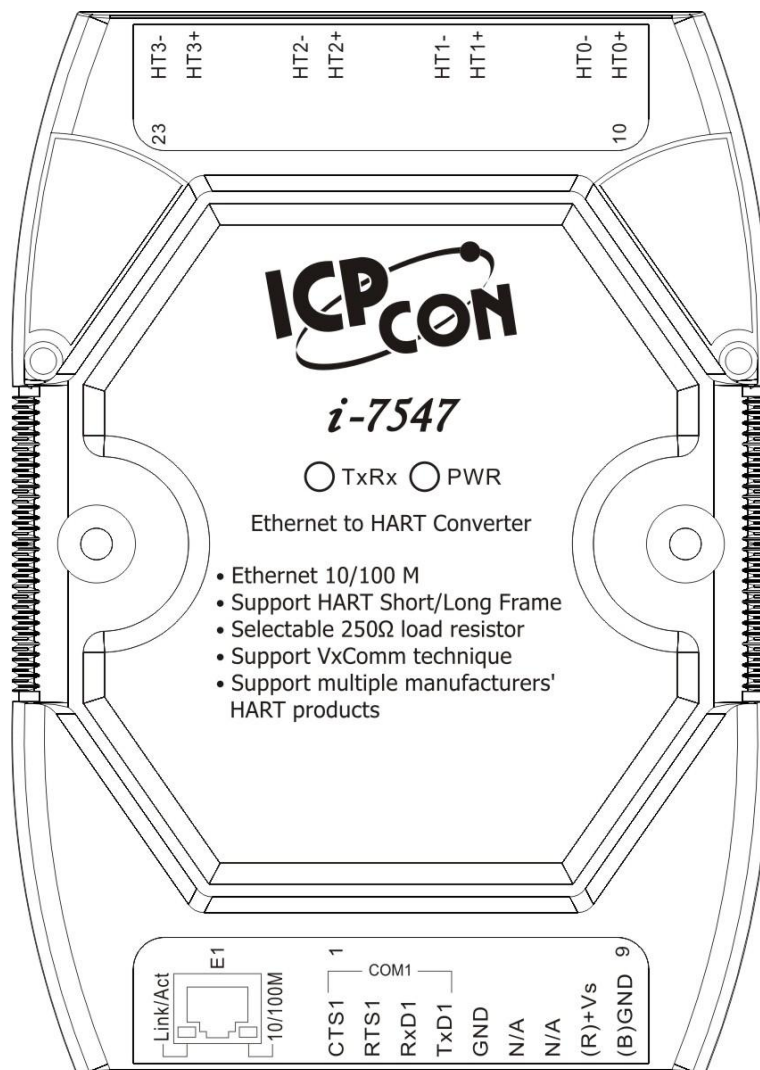

Figure 2-1: Hardware externals of I-7547

2.1 Pin Assignment of I-7547

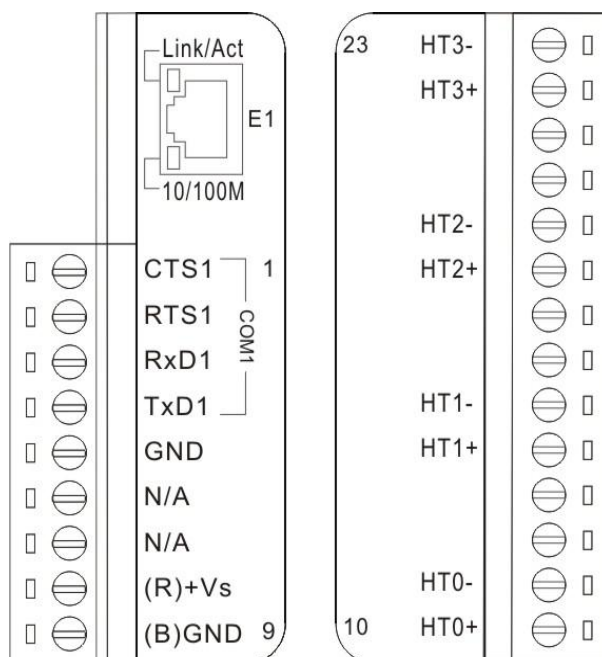

Figure 2-3: Pin Assignment of I-7547

2.1.1 Pin Function Description

Pin No.	Pin Name	Pin Function Description
1	CTS1	CTS of RS-232
2	RTS1	RTS of RS-232
3	RxD1	Receive Data of RS-232
4	TxD1	Transmit Data of RS-232
5	GND	GND of RS-232
6	-	N/A
7	-	N/A
8	+Vs	V+ of Power Supply (+10V~+30Vdc)
9	GND	GND of Power Supply
10	HT0+	HART+ of port 0
11	HT0-	HART- of port 0
12	-	N/A
13	-	N/A
14	HT1+	HART+ of port 1
15	HT1-	HART- of port 1
16	-	N/A

17	-	N/A
18	HT2+	HART+ of port 2
19	HT2-	HART- of port 2
20	-	N/A
21	-	N/A
22	HT3+	HART+ of port 3
23	HT3-	HART- of port 3
E1	Ethernet	10 / 100M

2.1.2 HART Wiring

The HART network connection can be divided into the following two types.

(1) **“Peer to Peer” Mode.**

[1] **“Loop Power” (Passive) Mode: (Internal Resistor)**

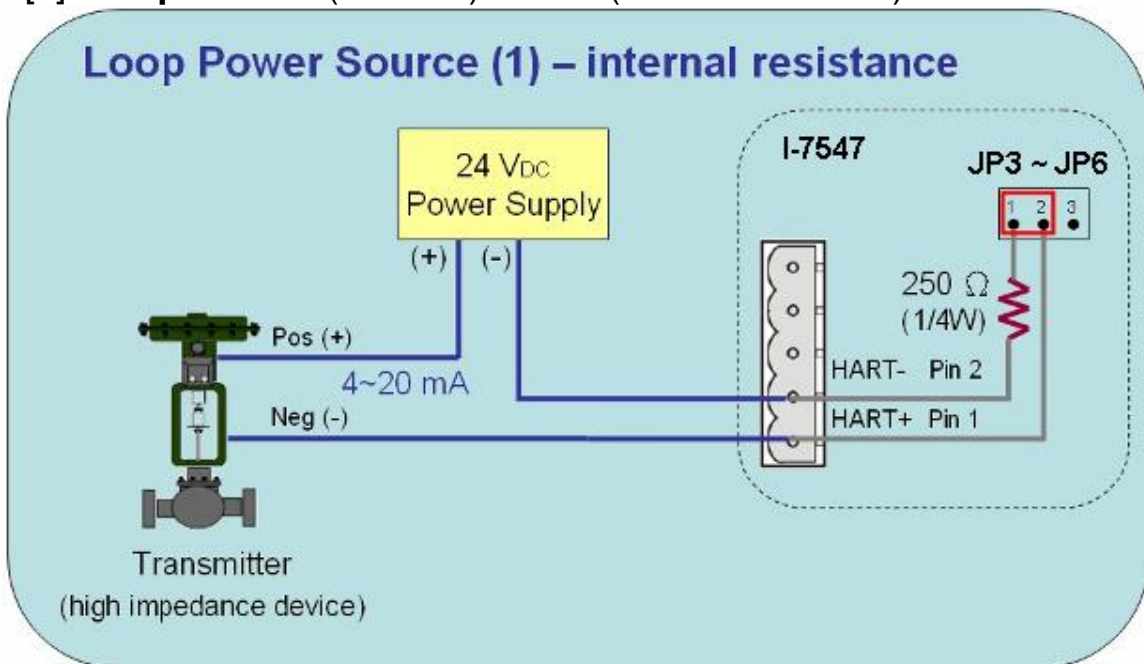

P2P => “Loop Power” Mode (Internal Resistor)

[2] **“Loop Power” (Passive) Mode: (External Resistor)**

Loop Power Source (2) – external resistance

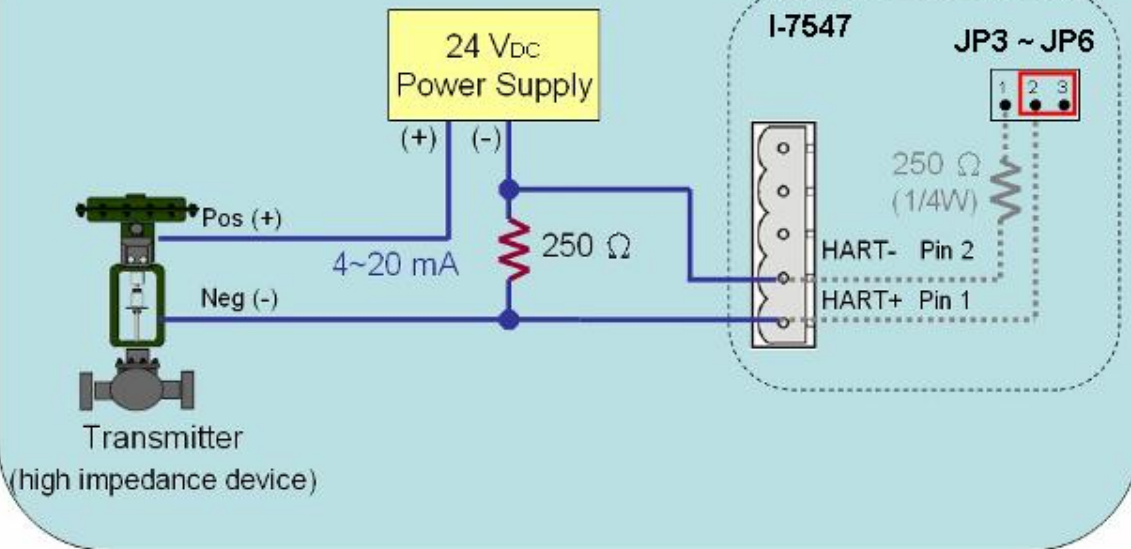

P2P => “Loop Power” Mode (External Resistor)

[3] “External Power” (Active) Mode:

External Power Source – external resistance

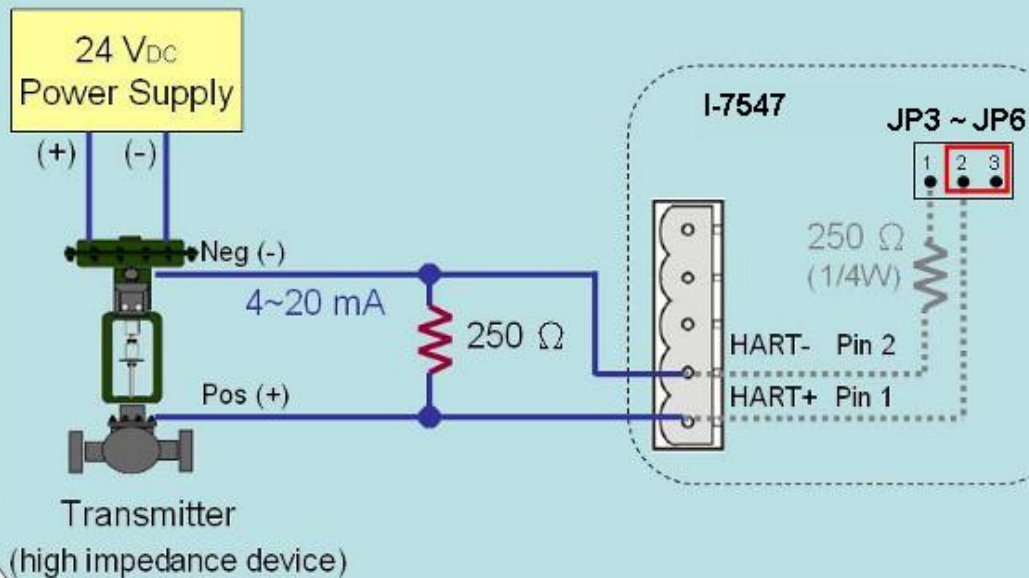

P2P => “External Power” Mode

(2) Multi-Drop Mode

[1] “Loop Power” (Passive) Mode:

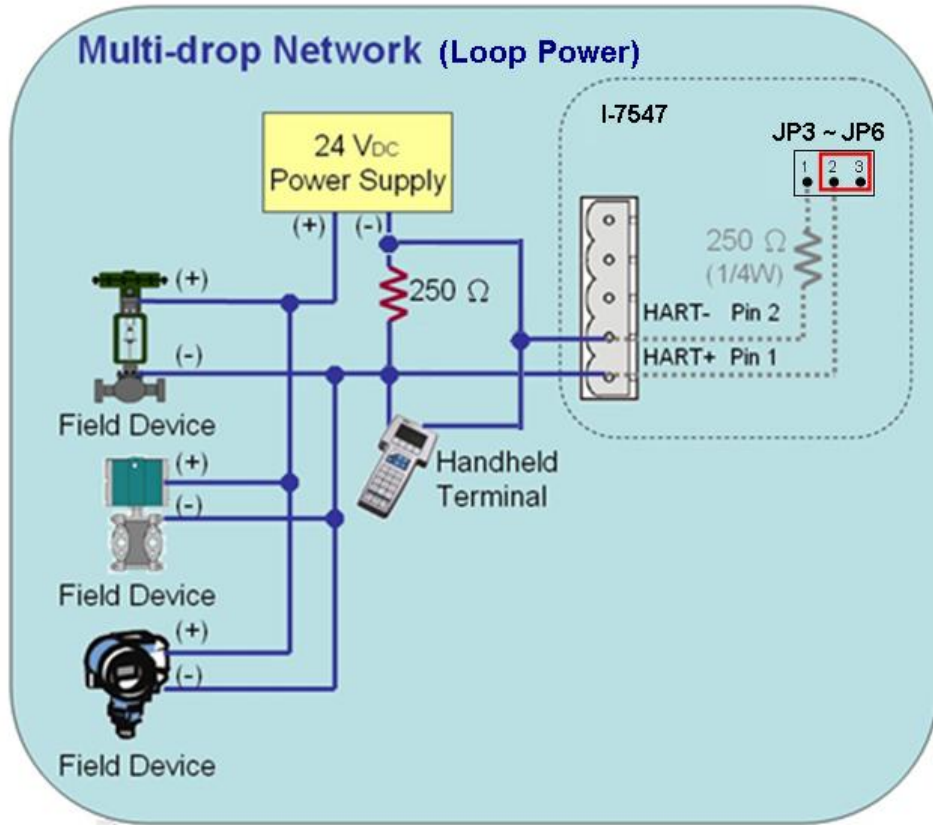

Multi-Drop => "Loop Power" Mode

(2) "External Power" (Active) Mode:

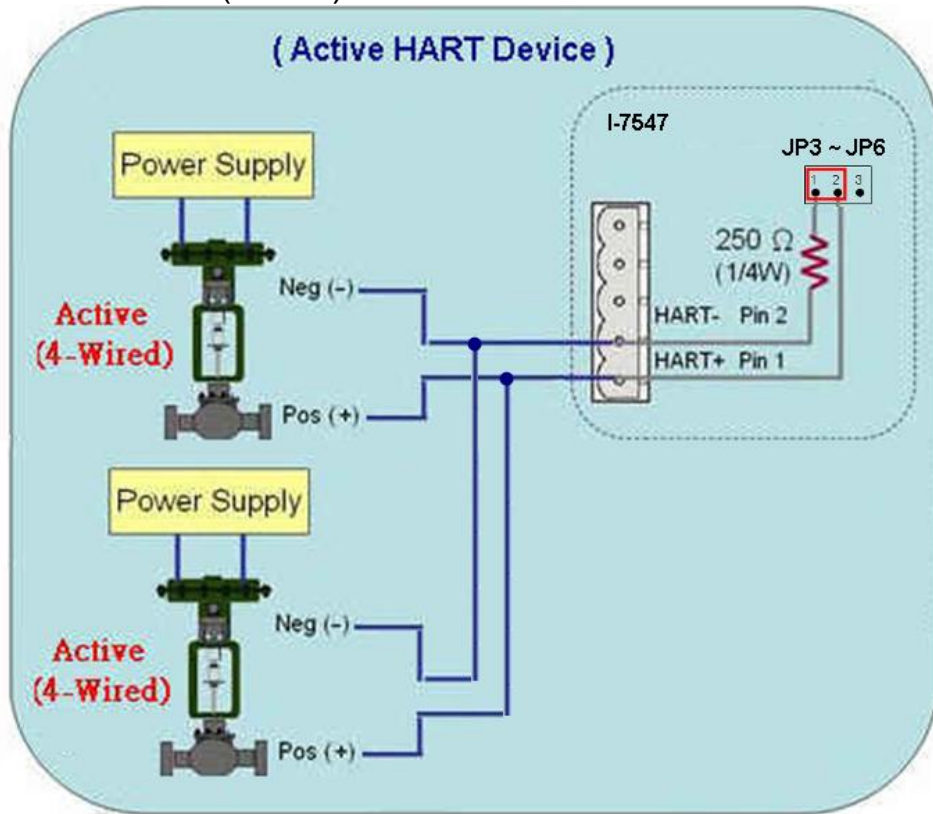

Multi-Drop => "External Power" Mode

(3) “Loop Power + External Power” (Passive+Active) Mode:

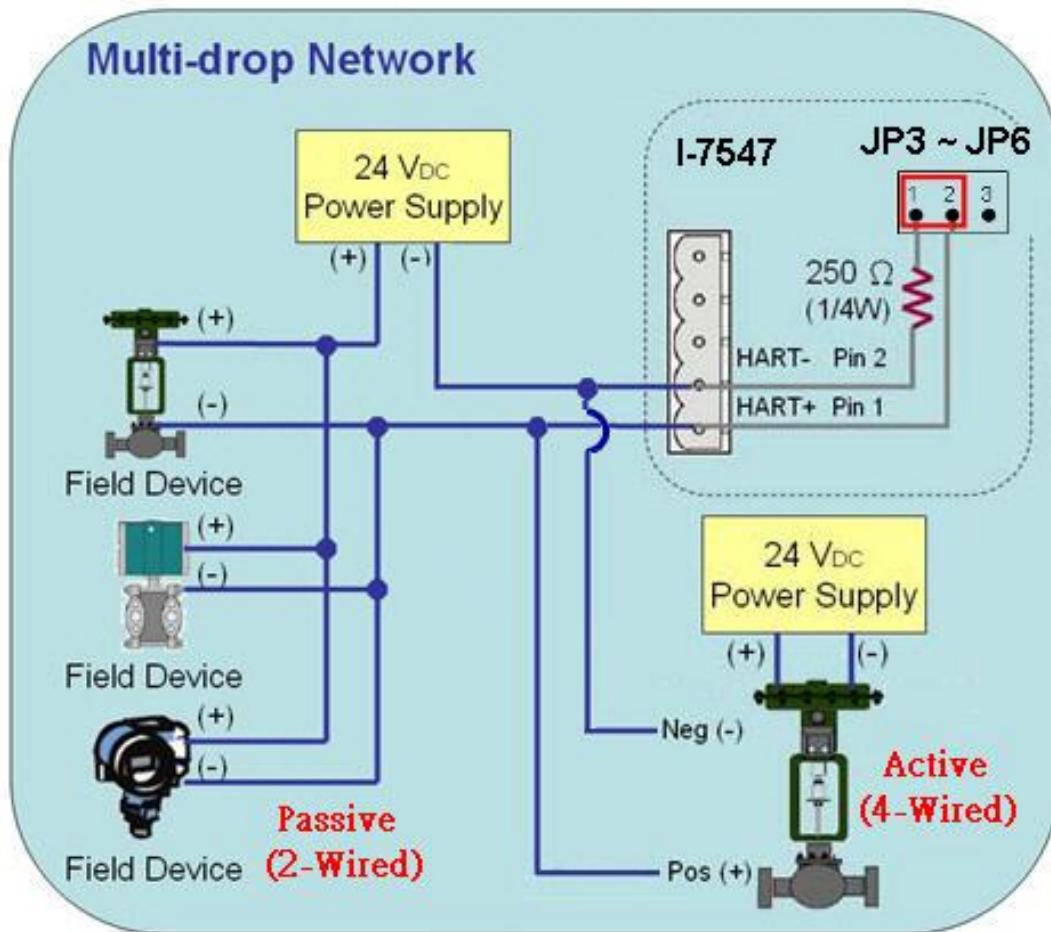

Multi-Drop => “Loop Power + External Power” Mode

2.2 Terminator Resistor Settings

In I-7547, there are four jumpers (JP3 ~ JP6) provided for four HART channels, shown as Figure 2-4. These jumpers can be used to connect or disconnect the 250Ω (1/4 W) loop resistor to HART network.

(1) **Enabled** HART loop resistor : Please connect the pin 1&2 together.

(1) **Disabled** HART loop resistor : Please connect the pin 2&3 together.

=> The default setting is enabled (the pin1&2 is connected)

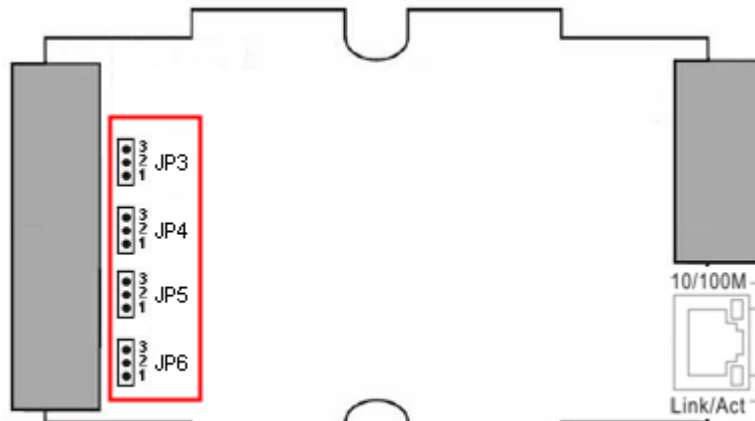

Figure 2-4: Internal Load Resistor

2.3 Init / Normal Dip-switch

There is a DIP switch on the back of the I-7547 module shown as the Figure 2-5.

(1) **“Init”** Mode function : [\(Modified to Lower position\)](#)

- [1] PWR LED will be ON after 5 seconds when power on.
- [2] Adopt module default IP address (192.168.255.1).
- [3] Firmware Update Mode.

(2) **“Normal”** Mode function : [\(Modified to Upper position\)](#)

- [1] PWR LED will be ON immediately when power on.
- [2] Adopt the IP address set by users.
- [3] Firmware Operation Mode.

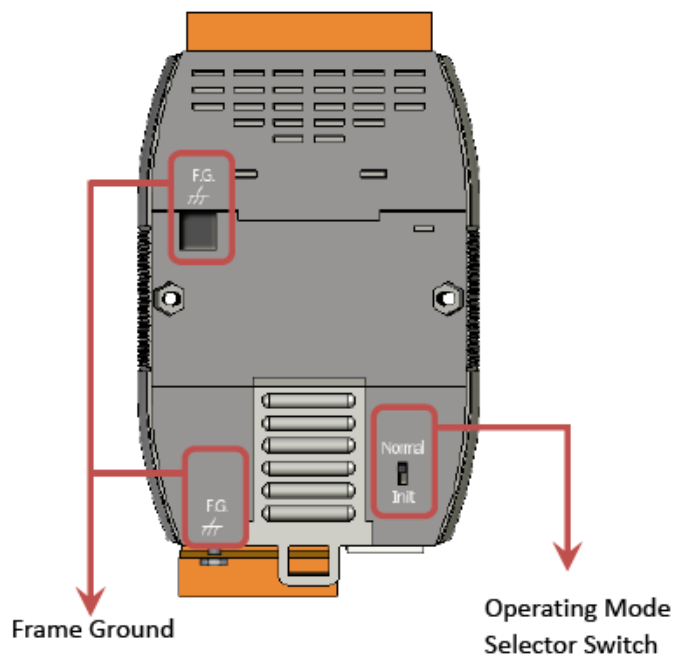

Figure 2-5: Dip Switch

2.3.1 Firmware Update Mode

Please follow the following instructions to complete the firmware update process of I-7547.

(1) Connect I-7547 to the same network with PC and make sure they can communicate with each other. (Please don't connect I-7547 to Internet, or it may cause the firmware update failure.)

(2) Run "eSearch" Utility.

(Download : ftp://ftp.icpdas.com/pub/cd/fieldbus_cd/hart/converter/i-7547/firmware/ and make sure the version is newer than v1.0.8) Click "Search Servers" button to search I-7547 module automatically. Right click on I-7547 item and choose the "Firmware Update" option to start firmware update process.

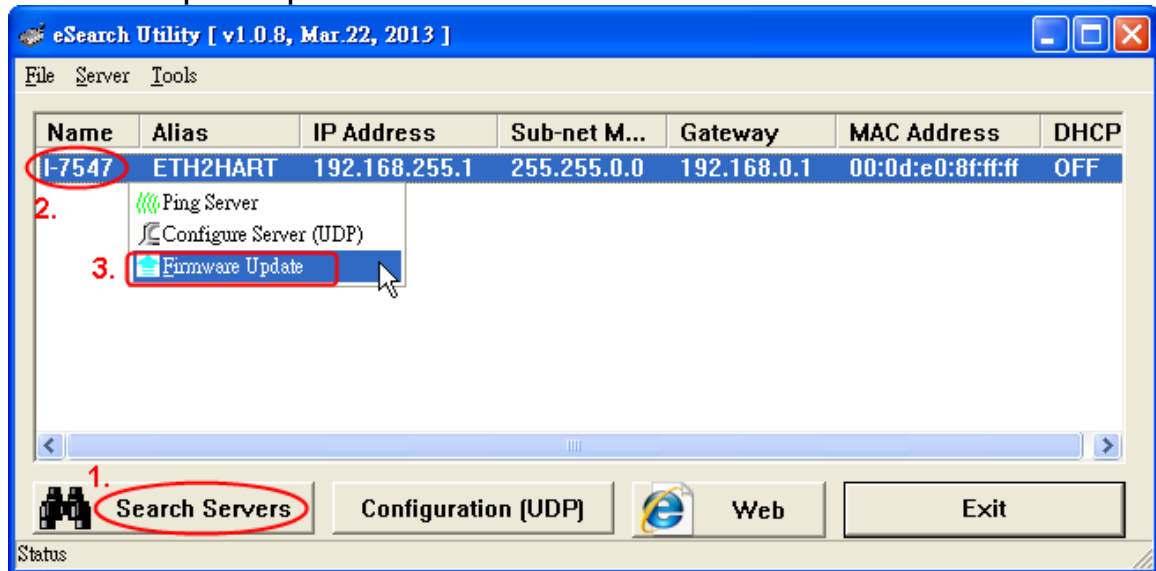

(3) Choose I-7547 firmware file.

(Download: ftp://ftp.icpdas.com/pub/cd/fieldbus_cd/hart/converter/i-7547/firmware/)

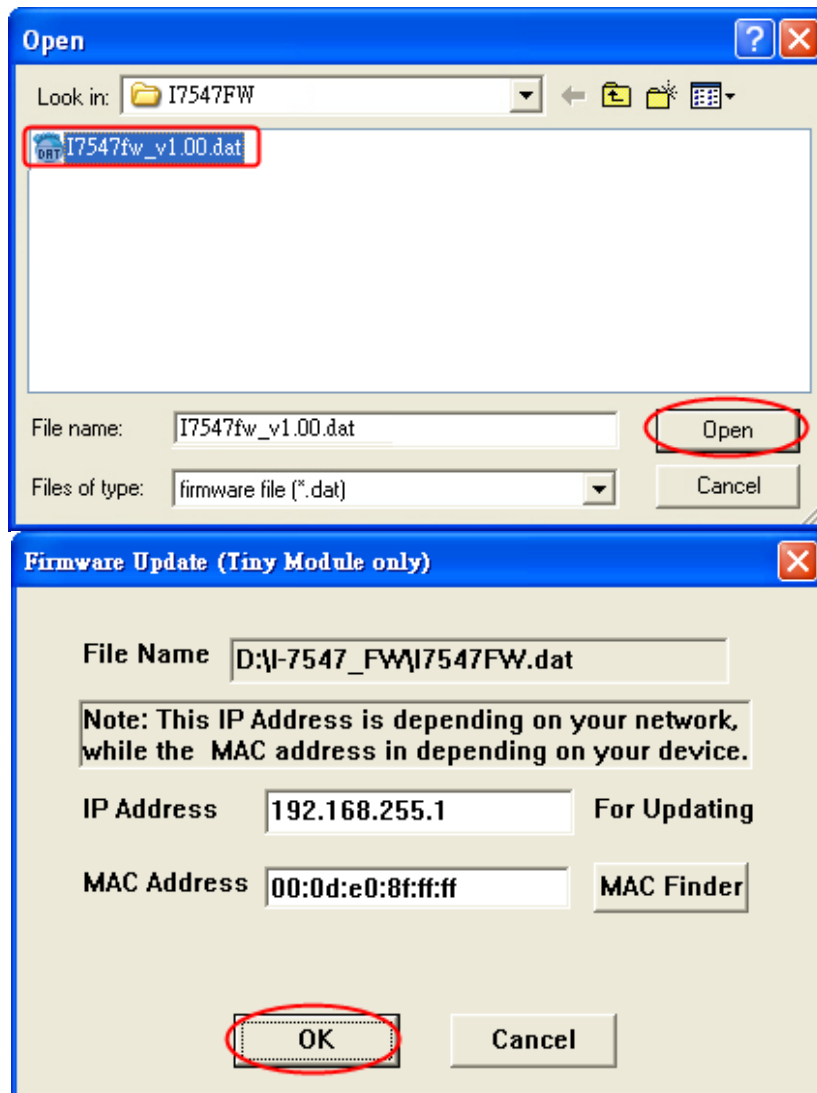

(4) In DOS command prompt, it will show the message for ready to update firmware.

```

C:\WINDOWS\system32\cmd.exe
Waiting request from MAC 00-0d-e0-8f-ff-ff <IP:192.168.255.1>
Starting BOOTP/TFTP Server ...
% Complete: 0%

```

(5) Set the dip switch to the “Init” position and reboot I-7547. After that, it will start to update firmware automatically.

If firmware updates successfully, the progress will run to 100%. If not, the following error message will show:

```

C:\Windows\system32\cmd.exe
Waiting request from MAC 00-0d-e0-80-55-71 <IP:192.168.255.1>
Starting BOOTP/TFTP Server ...
BOOTPREQ from MAC: 00-0D-E0-80-55-71

```

(6) After the process of firmware update finished, set the dip switch to the “Normal” position and reboot I-7547.

2.3.2 Firmware Operation Mode

Set the dip switch to the “Normal” position and then reboot I-7547. I-7547 will run under operation mode and then users can communicate with HART devices via Ethernet.

2.4 LED Indication

There are two LEDs provided to indicate the status of I-7547. The Figure 2-6 is the illustration of these two LEDs.

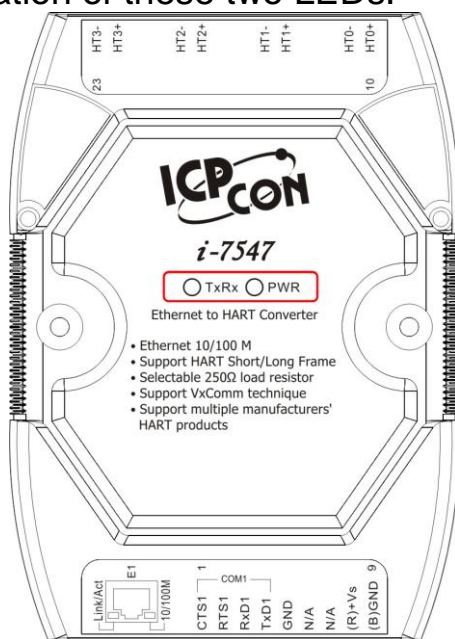

Figure 2-6: LED position of I-7547

2.4.1 LED Function

(1) PWR LED :

When I-7547 turned on, if it is in the firmware operation mode, then the PWR LED will be on immediately. If I-7547 is in the firmware update mode, after 5 seconds, it will switch from update mode to operation mode. When I-7547 turns off, all LEDs turn off.

(2) TxRxD LED :

When I-7547 is receiving data from Ethernet or HART port, then the TxRx LED will flash until data transmission completed.

2.4.2 LED Indication Table

LED Name \ Mode	Power off	FW Update	FW Operation	Ethernet Data Received	HART Port Data Received
PWR LED	Off	On after 5 sec when reboot	On immediately when reboot	On	On
TxRx LED	Off	Off	Off	Flash	Flash

2.5 Cable Selection

The HART bus is a balanced (differential) 2-wire interface running over a Shielded Twisted Pair (STP), Un-shielded Twisted Pair (UTP), or Ribbon cable. Please refer to the following table to decide what cable type, cable length, and terminator to use in the HART bus network.

No. Network Devices	Cable Capacitance – pf/ft (pf/m)			
	20 pf/ft (65 pf/m)	30 pf/ft (95 pf/m)	50 pf/ft (160 pf/m)	70 pf/ft (225 pf/m)
1	9,000 ft (2,769 m)	6,500 ft (2,000 m)	4,200 ft (1,292 m)	3,200 ft (985 m)
5	8,000 ft (2,462 m)	5,900 ft (1,815 m)	3,700 ft (1,138 m)	2,900 ft (892 m)
10	7,000 ft (2,154 m)	5,200 ft (1,600 m)	3,300 ft (1,015 m)	2,500 ft (769 m)
15	6,000 ft (1,846 m)	4,600 ft (1,415 m)	2,900 ft (892 m)	2,300 ft (708 m)

Allowable cable lengths for 1.0mm (#18 AWG) shield twisted pair

Note: The AWG means a standard method used to measure wire. The numbering system works backwards from what people would think, the thicker (heavier) the wire, the lower the number.

3. Web Server Configuration

I-7547 provides the built-in web server for module Ethernet parameter setting.

3.1 Connect to I-7547 Web Server

[Step 1: Type “IP Address” in the Web Browser]

I-7547 supports many kinds of web browser like Mozilla, Firefox, Google Chrome and IE etc. The default IP address of I-7547 is “192.168.255.1”.

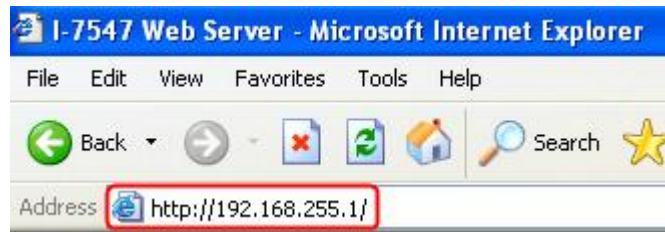

[Step 2: Type “Password” in Log-In screen]

When connecting to I-7547 web server, please input the password in the “Login password” field (**Default Password : admin**) and click “Submit” button to log in.

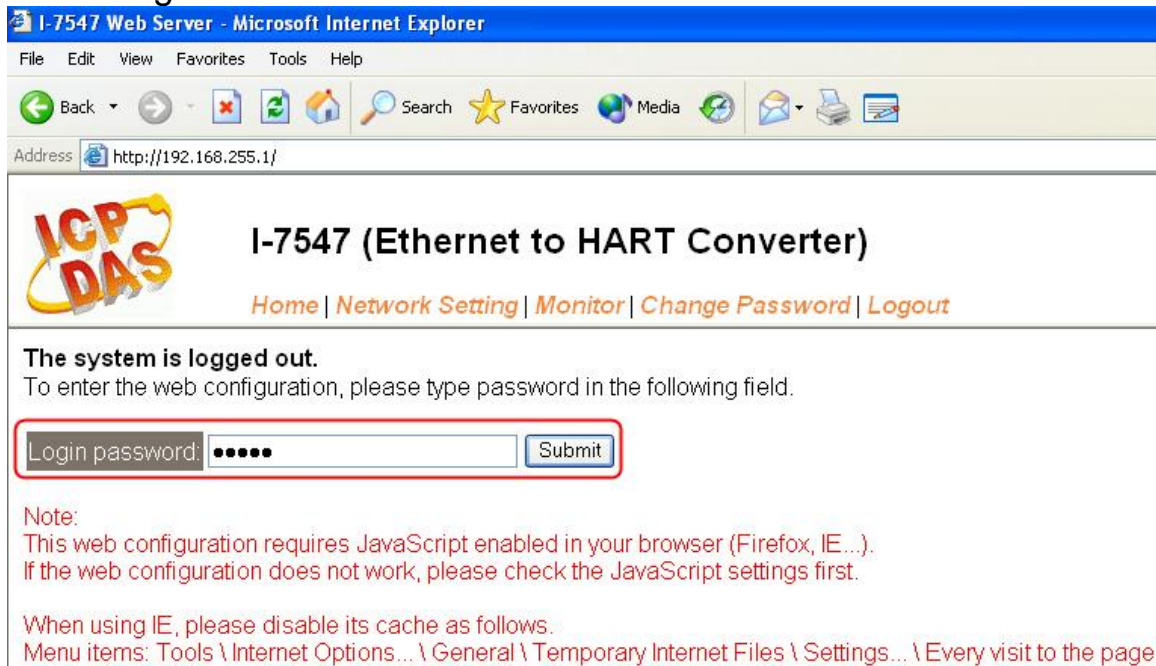

3.2 Home

Provide the basic software and hardware information of I-7547.



I-7547 (Ethernet to HART Converter)

[Home](#) | [Network Setting](#) | [Monitor](#) | [Change Password](#) | [Logout](#)

System Information

Model Name:	I-7547	Alias Name:	ETH2HART
Firmware Version:	v1.00 [2013/04/25]	MAC Address:	00-0d-e0-8f-ff-ff
IP Address:	192.168.255.1	TCP Command Port:	10000
Initial Switch:	OFF	System Timeout: (Network Watchdog, Seconds)	300

3.3 Network Setting

Provide following configuration.

(1) IP Address Setting:

Provide module Ethernet communication configuration.

IP Address	
Address Type:	Static IP <input type="button" value="v"/>
Static IP Address:	<input type="text" value="192"/> <input type="text" value="168"/> <input type="text" value="255"/> <input type="text" value="1"/>
Subnet Mask:	<input type="text" value="255"/> <input type="text" value="255"/> <input type="text" value="0"/> <input type="text" value="0"/>
Default Gateway:	<input type="text" value="192"/> <input type="text" value="168"/> <input type="text" value="0"/> <input type="text" value="1"/>
MAC Address:	<input type="text" value="00-0d-e0-8f-ff-ff"/> (Format: FF-FF-FF-FF-FF-FF)
Virtual COM	
TCP Command Port:	<input type="text" value="10000"/> (Default: 10000)
Command Port Timeout: (Socket Watchdog)	<input type="text" value="180"/> (1 ~ 65535 seconds, 30=default, 0=disable)
<input type="button" value="Update Settings"/>	

Items	Description
Address Type	[Static IP] If there is no DHCP server in the network, then static IP can be assigned to I-7547.

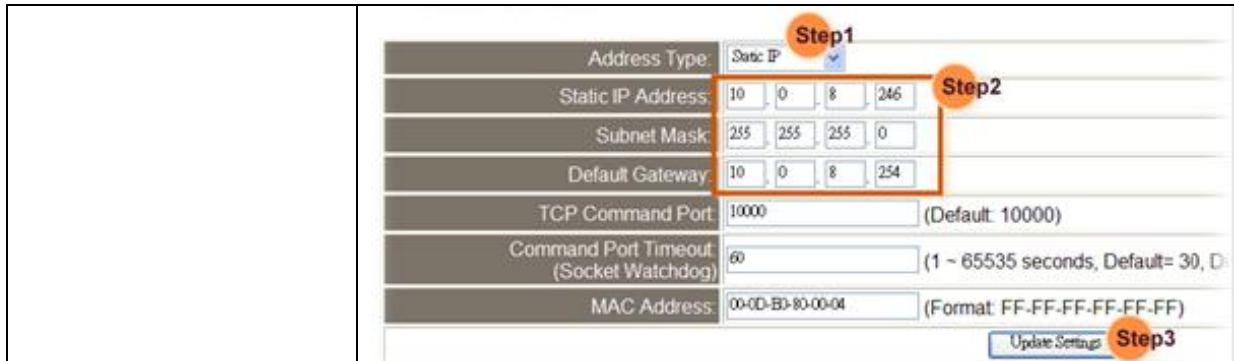

[DHCP / AutoIP]

If there is a DHCP server in the network, then I-7547 can be assigned to the IP address automatically. When I-7547 reboots, the IP address of I-7547 assigned by the DHCP server may be different.

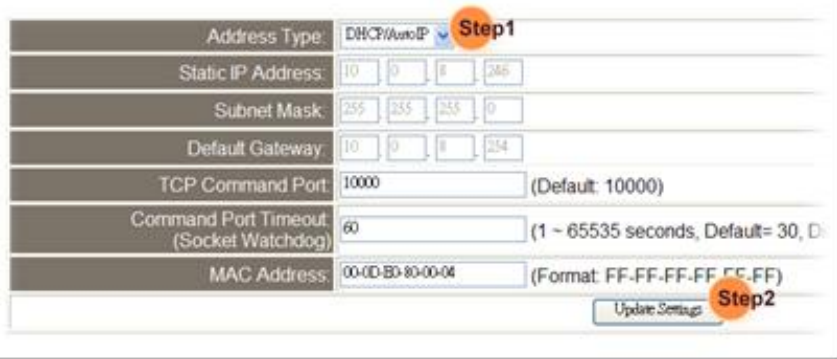

Static IP Address	Set the static IP address.
Subnet Mask	Set the subnet mask.
Default Gateway	Set the gateway.
MAC Address	Set the user-defined MAC address.
TCP Command Port	Default TCP command port is 10000.
Command Port Timeout (Socket Watchdog)	If command port doesn't receive any TCP/IP data within the timeout, then I-7547 will be disconnected automatically. Range : 1~65535 (seconds); Default : 30 (seconds); Disabled = 0
Update Settings	Click the button to save the new settings to I-7547.

(2)General Setting:

Provide the general module configuration like module alias, watchdog and web auto-logout etc.

Network	
System Timeout: (Network Watchdog)	300 (30 ~ 65535 seconds, 300=default, 0=disable) Action=Reboot
Web Auto-logout:	10 (1 ~ 255 minutes, 10=default, 0=disable)
CGI Configuration:	Enable (Enable/Disable the assign.cgi, Enable=default.)
UDP Alarm	
Alarm IP Address(UDP):	255 . 255 . 255 . 255
Alarm Port(UDP):	54300
Misc.	
Alias Name:	ETH2HART (Max. 18 chars)
UART Watchdog:	Tx:0 Rx:0 (30 ~ 65535 seconds, 0=default=disable) Action=Reboot
Debug Message(UDP):	20 (1 ~ 255 seconds, 20=default, 0=disable)
<input type="button" value="Update Settings"/>	

Items	Description	Default
Alias Name	Set the module alias so it is easier to identify in the network.	ETH2HART
System Timeout (Network WDT)	Set the system timeout value. (When error occurs and lost communication, I-7547 will reboot automatically after system timeout value passed.) Range : 30~65535 (seconds); Disabled = 0;	300
Web Auto-logout	Set the timeout value for web auto-logout. (If there is no action on the I-7547 web server for a period of time, then it will log out automatically.) Range : 1~65535 (minutes); Disabled = 0;	10
Update Settings	Click the button to save the new settings to I-7547.	

(3) Restore Factory Defaults:

Provide restoration to the factory default settings of I-7547.

[1] Click “Restore Defaults” button to restore the factory default settings.



[2] Click “OK” button to finish the setting.

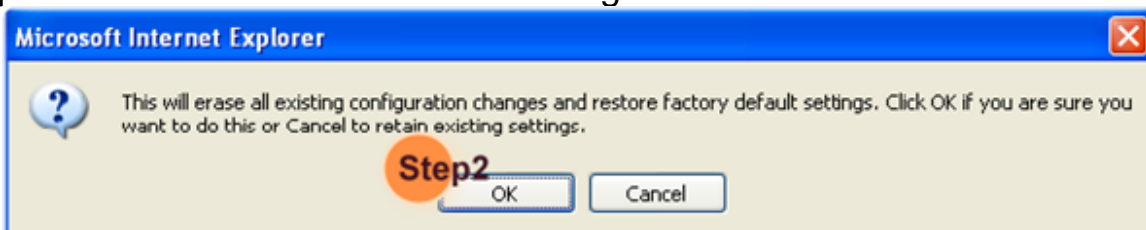

Items	Factory Default
IP	192.168.255.1
Gateway	192.168.0.1
Mask	255.255.0.0

(4) Forced Reboot:

Provide remote reboot I-7547 module via web.

3.4 Monitor

Provide the connection status and transmitted data byte count of the “Ethernet to COM” and “Ethernet to HART” function.



I-7547 (Ethernet to HART Converter)

[Home](#) | [Network Setting](#) | **Monitor** | [Change Password](#) | [Logout](#)

Connection Status (Ethernet) :

Port Number	COM 1	HART
Client/Server Mode:	Server	Server
Connected IP1:	192.168.255.203	192.168.255.203
IP2:	0.0.0.0	0.0.0.0
IP3:	0.0.0.0	0.0.0.0
IP4:	0.0.0.0	0.0.0.0

- (1) COM1: The VxComm connection status of “Ethernet to COM”.
- (2) HART: The VxComm connection status of “Ethernet to HART”.

Tx/Rx Count (COM/HART) :

Port Number	COM 1	HART
Last Tx Count (bytes):	0	0
Last Rx Count (bytes):	0	0
Total Tx Count (bytes):	14	55
Total Rx Count (bytes):	21	0

- (1) COM1: The Tx/Rx byte count of “Ethernet to COM”.
- (2) HART: The Tx/Rx byte count of “Ethernet to HART”.

3.5 Change Password

Provide the new password setting for web server login.



I-7547 (Ethernet to HART Converter)

[Home](#) | [Network Setting](#) | [Monitor](#) | **[Change Password](#)** | [Logout](#)

Change Password

The length of the password is 12 characters maximum.

Current password:	<input type="password" value="*****"/>
New password:	<input type="password" value="*****"/>
Confirm new password:	<input type="password" value="*****"/> <input type="button" value="Submit"/>

Items	Description
Current password	Input the old password. (Default : admin)
New password	Input the new password.
Confirm new password	Input the new password again.
Submit	Click the button to save the new settings to I-7547.

3.6 Logout

When click the “Logout” label, it will logout from the web server of I-7547 automatically and redirect to the login screen.



I-7547 (Ethernet to HART Converter)

[Home](#) | [Network Setting](#) | [Monitor](#) | [Change Password](#) | **[Logout](#)**

The system is logged out.

To enter the web configuration, please type password in the following field.

Login password:	<input type="password"/>	<input type="button" value="Submit"/>
-----------------	--------------------------	---------------------------------------

3.7 Port1 / Port2 Settings (Support Pair-Connection)

When click the “Port1” or “Port2” label, it will provide the setting of “Pair-Connection” function. (The function needs to use two I-7547 modules and connect these two I-7547 Ethernet ports in the same network.)

(1)Port1 Page: The Pair-Connection settings for **COM1** port. (Port 10001)

(2)Port2 Page: The Pair-Connection settings for **HART** port. (Port 10002)

Server / Client Settings of “Pair-Connection”:

Items	I-7547 Server Setting	I-7547 Client Setting
Server Mode	Server	Client
Remote Server IP	Disable	Remote I-7547 Server IP
Remote TCP Port	Disable	Port1: 10001 (COM) Port2: 10002 (HART)
Submit Button	Click the button to save the new settings to I-7547.	



I-7547 (Ethernet to HART Converter)

Home **Port1** **Port2** Network Setting | Monitor | Change Password | Logout

Dynamic Serial Setting:	Enable	Enable
Operation Mode:	0	0 (0=Data-sharing, 1=Non-sharing) (=TCP Command Port +2)
Local TCP Port:	10002	
TCP Timeout (seconds):	180	180 (1 ~ 65535, 180=default, 0=disable)
Serial Data Packing:	Current	Updated
Slave Timeout (ms):	1000	1000 (After last TX)
Packing Length(bytes):	0	0 (0 ~ 1024, 0=default=disable)
Serial Ending Chars: (Number,char1[,char2])	0	0 (e.g.: 2,0x0D,0x0A)
Timeout Between Chars (ms):	10	10 (After last RX) (10 ~ 65535, 10=default, 0=disable)
Pair-Connection Settings (Client/Server Mode)	Current	Updated
Server Mode:	Server	Server (Server=Slave, Client=Master)
Remote Server IP:	Disable	10 . 0 . 8 . 244
Remote TCP Port:	Disable	10002
		<input type="button" value="Submit"/>

(1) Enable HART “Pair-Connection” :

Set the Server Mode to be “**Server**” in one I-7547 and Set another I-7547 to be “**Client**”. In client mode, the “Remote Server IP” and “TCP Port” parameters need to be configured.

(2) Disable “Pair-Connection” :

Set the Server Mode to be “**Server**” in two I-7547 modules to disable the function.

=> Remember to click “Submit” button to save settings to I-7547.

I-7547 Server Settings:

Pair-Connection Settings (Client/Server Mode)	Current	Updated
Server Mode:	Server	Server (Server=Slave, Client=Master)
Remote Server IP:	Disable	10 . 0 . 8 . 244
Remote TCP Port:	Disable	10002

I-7547 Client Settings:

Pair-Connection Settings (Client/Server Mode)	Current	Updated
Server Mode:	Client	Client (Server=Slave, Client=Master)
Remote Server IP:	192.168.255.1	192 . 168 . 255 . 1
Remote TCP Port:	10002	10002

4. HC_Tool Utility

4.1 VxComm Utility

Before using HC_Tool utility to communicate with I-7547, please install the “VxComm Utility” software first to create a virtual com port.

(1) Install the “VxComm Utility”.

(Download:

<http://www.icpdas.com/root/product/solutions/software/utilities/vxcomm.html> and make sure the version is newer than v2.12) °

(2) Run the “VxComm Utility”.

Click the “Search Servers” button to search all I-7547 modules automatically.

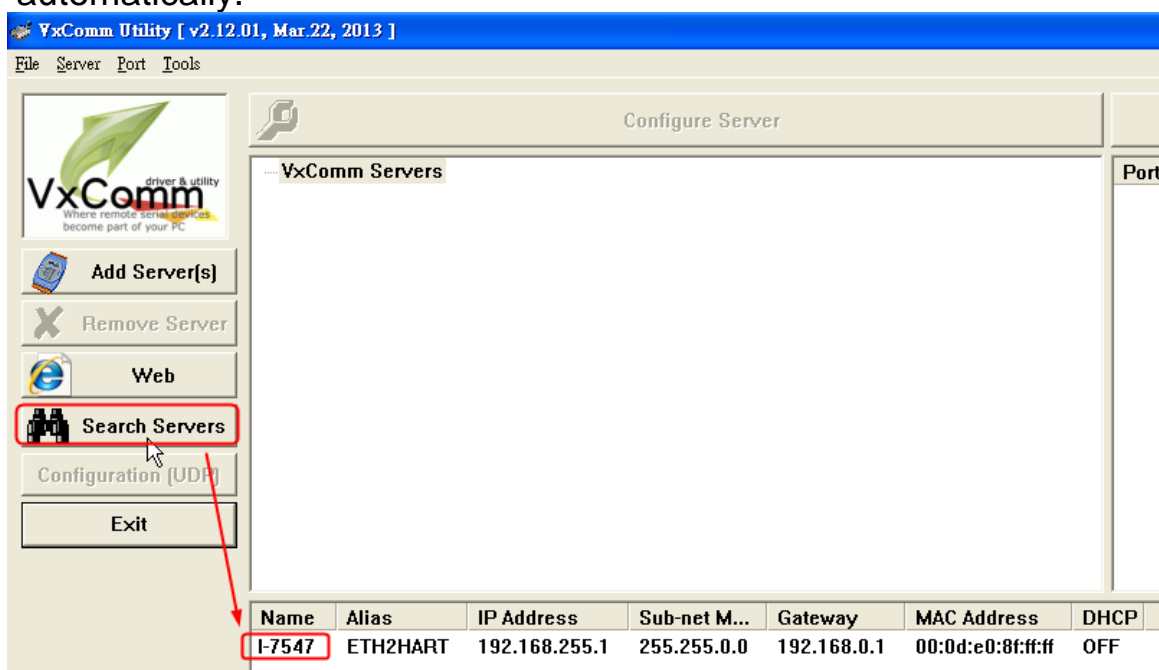

(3) Right click the “I-7547” item(s) and choose the “Add Server(s)” option.

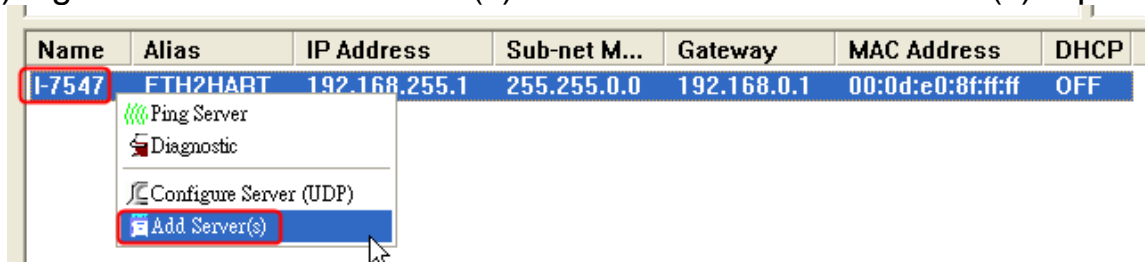

(4) In “COM Port:” item, choose the com port number.

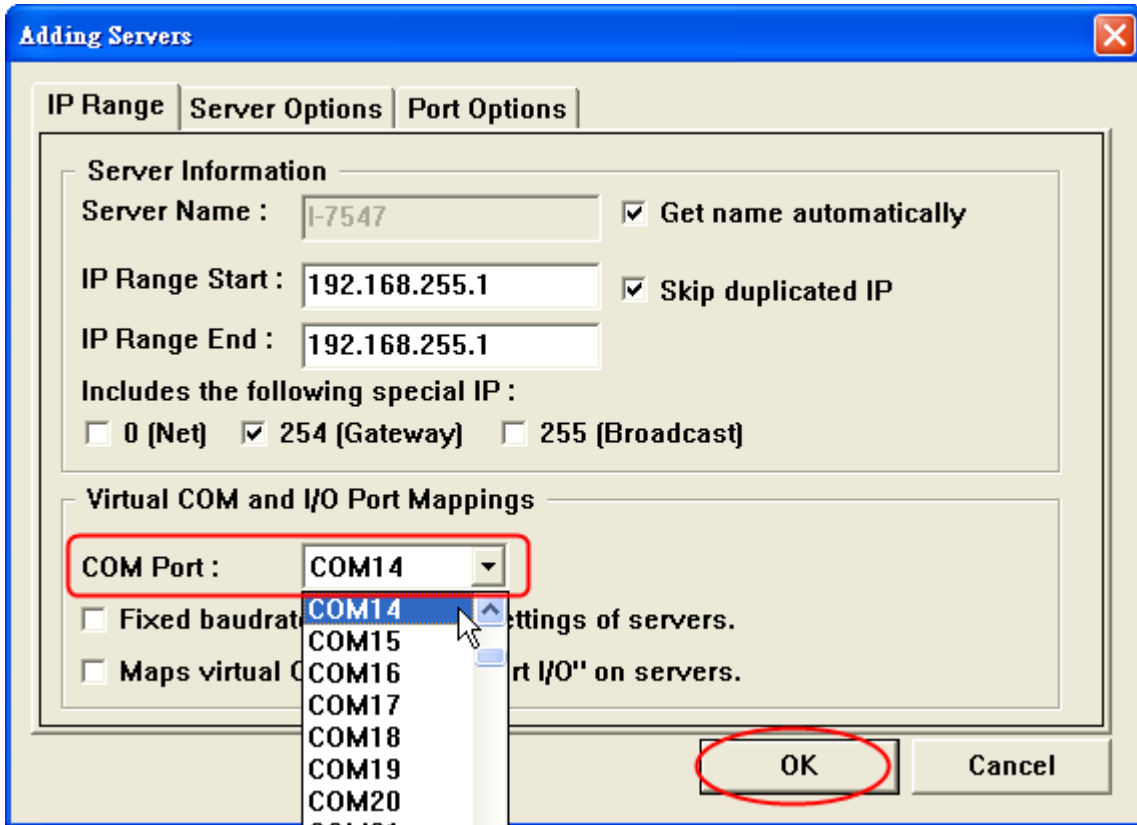

(5) If success, the “I-7547” item will be listed in the above “VxComm Servers” list. The virtual com port will be shown in the right field like Port1 and Port2.

- [1] Port 1 (COM14) : The virtual com port for Ethernet to COM.
- [2] Port 2 (COM15) : The virtual com port for Ethernet to HART.

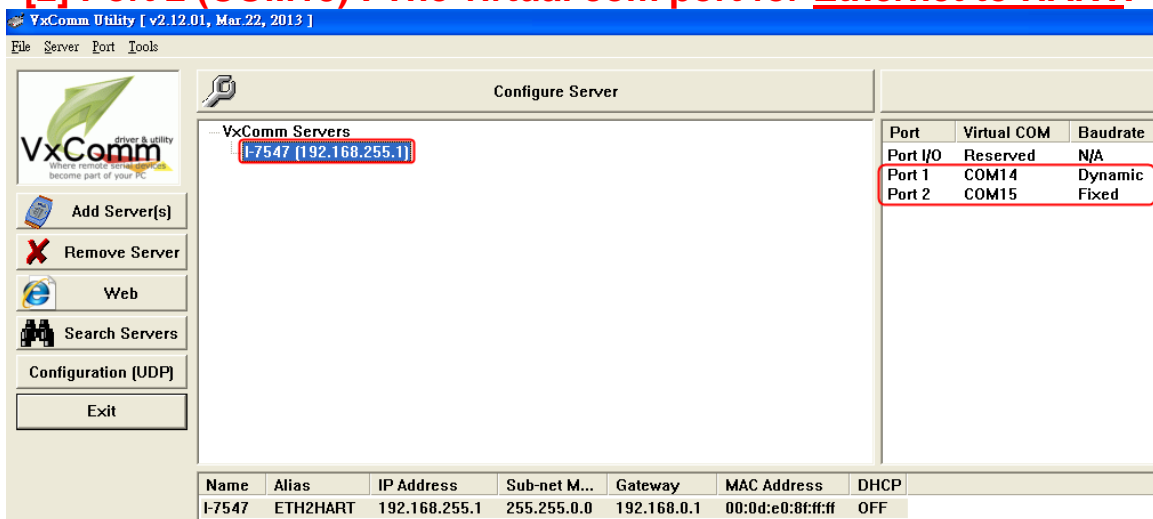

(6) Click “Tools” menu and choose the “Restart Driver” option then it will enable the virtual com port settings.

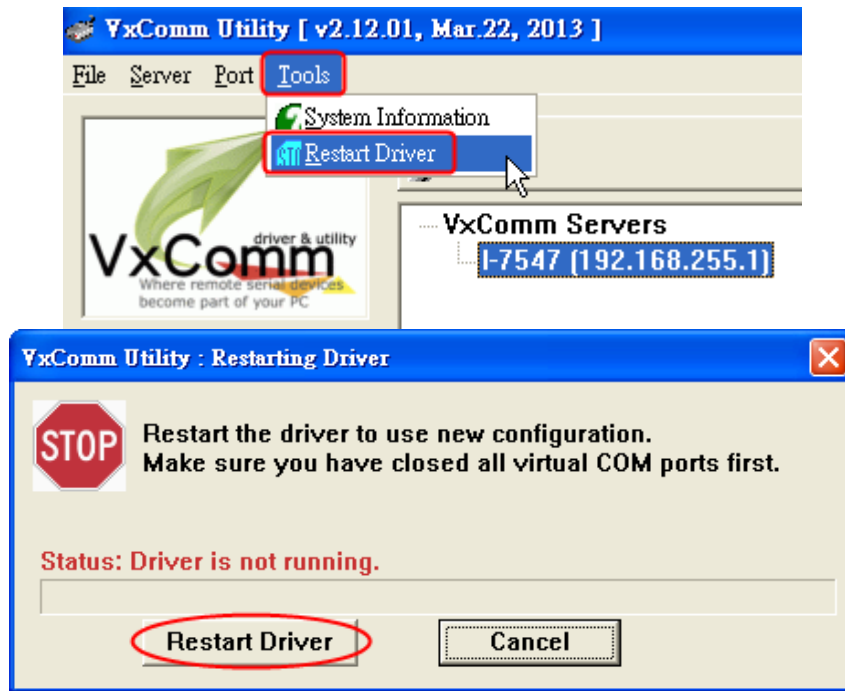

4.2 Run HC_Tool

HC_Tool utility is provided to configure all ICP DAS's HART converter modules (like I-7567 / I-7570 / I-7547) and transmit / receive HART frame for HART communication easily and quickly. HC_Tool utility can be downloaded from the ICP DAS website :

http://ftp.icpdas.com/pub/cd/fieldbus_cd/hart/converter/i-7547/software/.

Run the "HC_Tool", like Figure 4-1. If users can't run "HC_Tool", please install .NET Framework 3.5 first.

(<http://www.microsoft.com/downloads/details.aspx?familyid=333325FDAE52-4E35-B531-508D977D32A6&displaylang=en>).

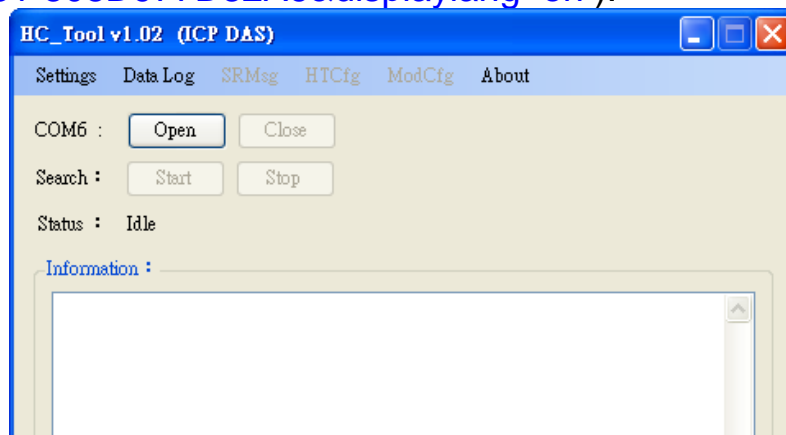

Figure 4-1: HC_Tool Utility

4.3 Serial Port and HART Command Settings

Please click “**Settings**” menu to open settings window of serial port and HART parameters like Figure 4-2.

4.3.1 Serial port settings

- (1) Please select serial port no. of PC like Figure 4-2.
- (2) “**Timeout**” Field: HART command Timeout value. The default value is 650ms. (Supported by HC_Tool v1.04 or newer. When using HART pair-connection function, suggest to set the timeout value to be 2000 (2 sec))

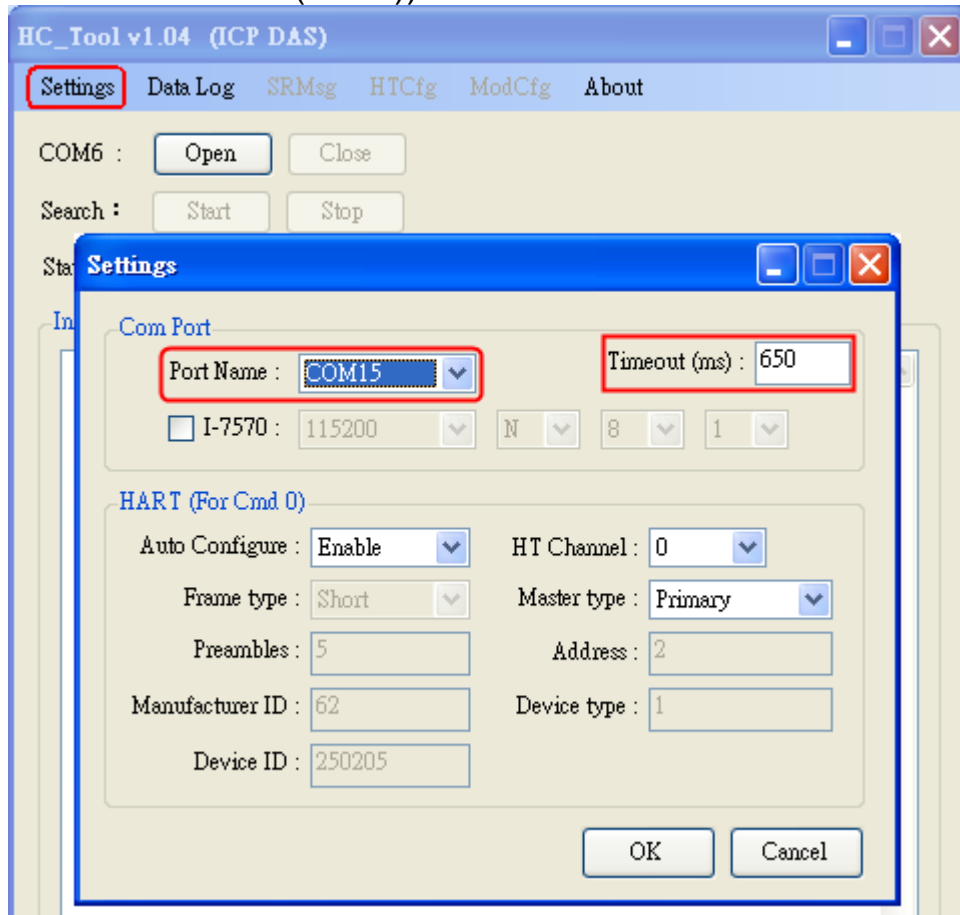

Figure 4-2: Set Serial Port No.

4.3.2 HART Frame Settings

The following are the descriptions of HART command fields.

- Auto Configure** : (1) Enable : search HART devices automatically.
- (2) Disable : search HART devices according to manual parameters.

- HT Channel : Select HART channel no.
- Frame type : Select HART frame format (Short/Long).
- Master type : Select Primary master or Secondary master.
- Preambles : Select 5~20 bytes (0xFF) number.
- Address : Select HART Polling Address (0~15).
- Manufacturer ID: Manufacturer Identification Code
- Device type : Manufacturer Device Type Code
- Device ID : Manufacturer Device Identification Code.

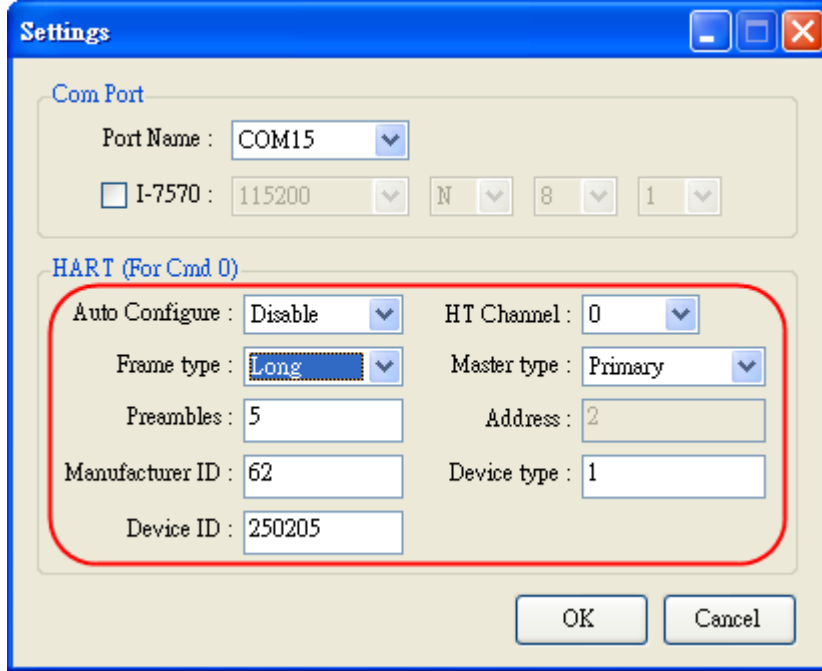

Figure 4-3: Set HART Frame Format

4.4 Search HART devices

4.4.1 Search HART devices automatically

Set the option of “Auto Configure” field to be “Enable” and the option of “Master type” field to be “Secondary” like Figure 4-4. Then HC_Tool utility will automatically search all HART devices by using HART short frame with “Secondary Master” identity.

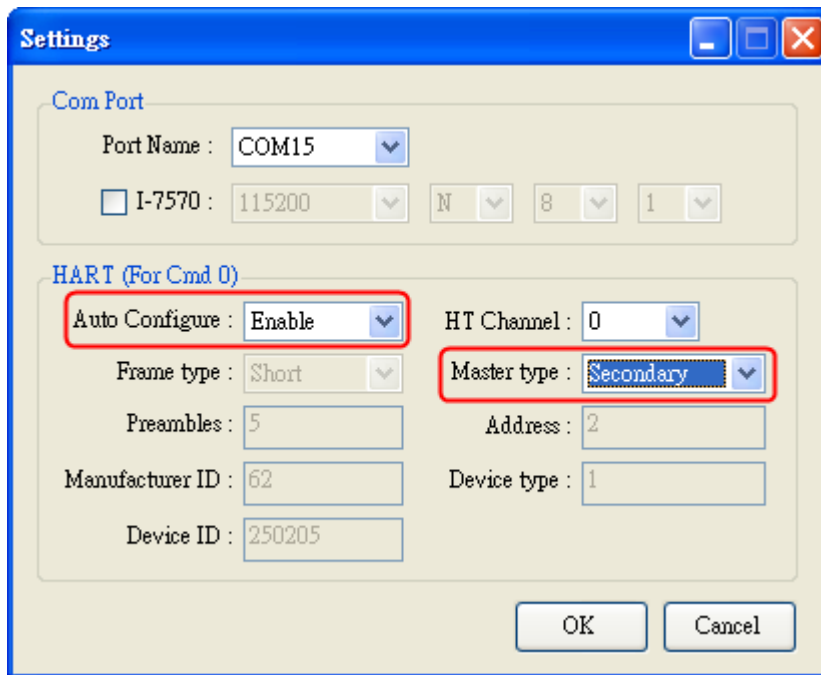

Figure 4-4: Auto Configure - Enable

4.4.2 Search HART devices manually

Set the option of “Auto Configure” field to be “Disable” and then users can set the HART frame manually to search HART devices.

- (1) If the option of “Frame type” field is “Short”, then “Master type”, “Preambles”, “Address” fields need to be configured like Figure 4-5.

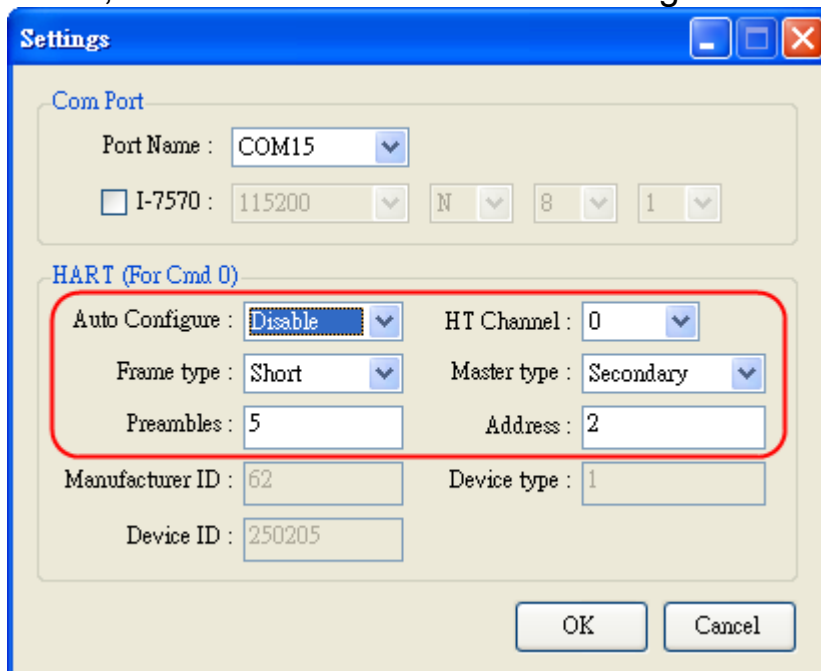

Figure 4-5: Short frame settings

- (2) If the option of “Frame type” field is “Long”, then “Master type”, “Preambles”, “Manufacturer ID”, “Device type”, “Device ID” fields need to be configured like Figure 4-6.

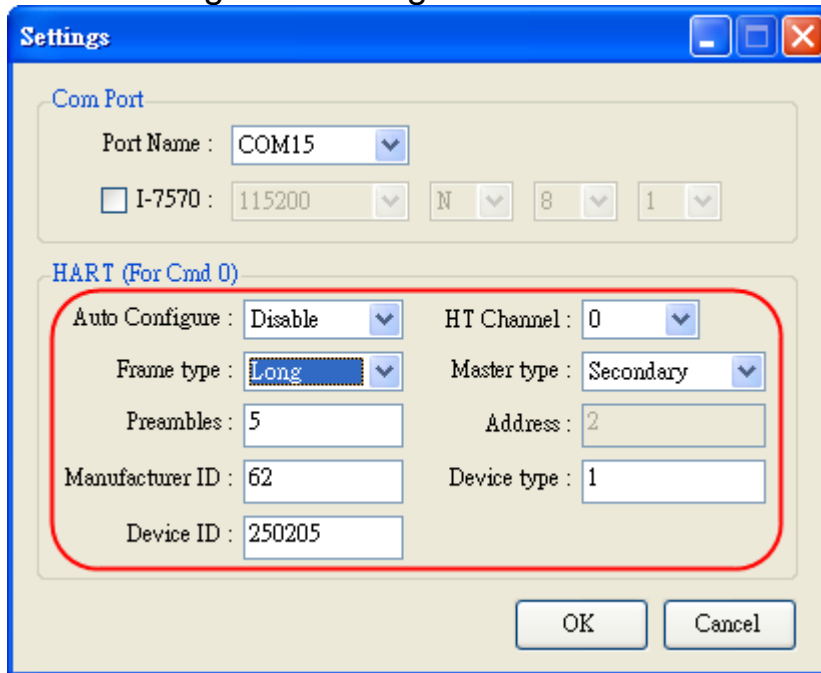

Figure 4-6: Long frame settings

If the setting of serial port and HART frame format is finished, please click the “OK” button. Then users can test the HART communication.

4.4.3 Search HART devices

- (1) Click “**Open**” button to open the com port of PC like Figure 4-7. If com port open failed, please check the com port setting.

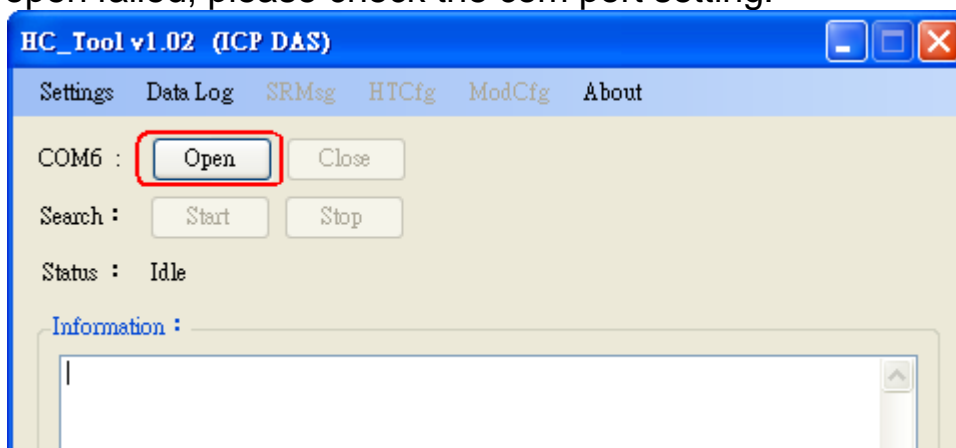

Figure 4-7: Click “Open” button

- (2) Click “**Start**” button to search all HART devices and the result will be shown in the “Information” field like Figure 4-8.

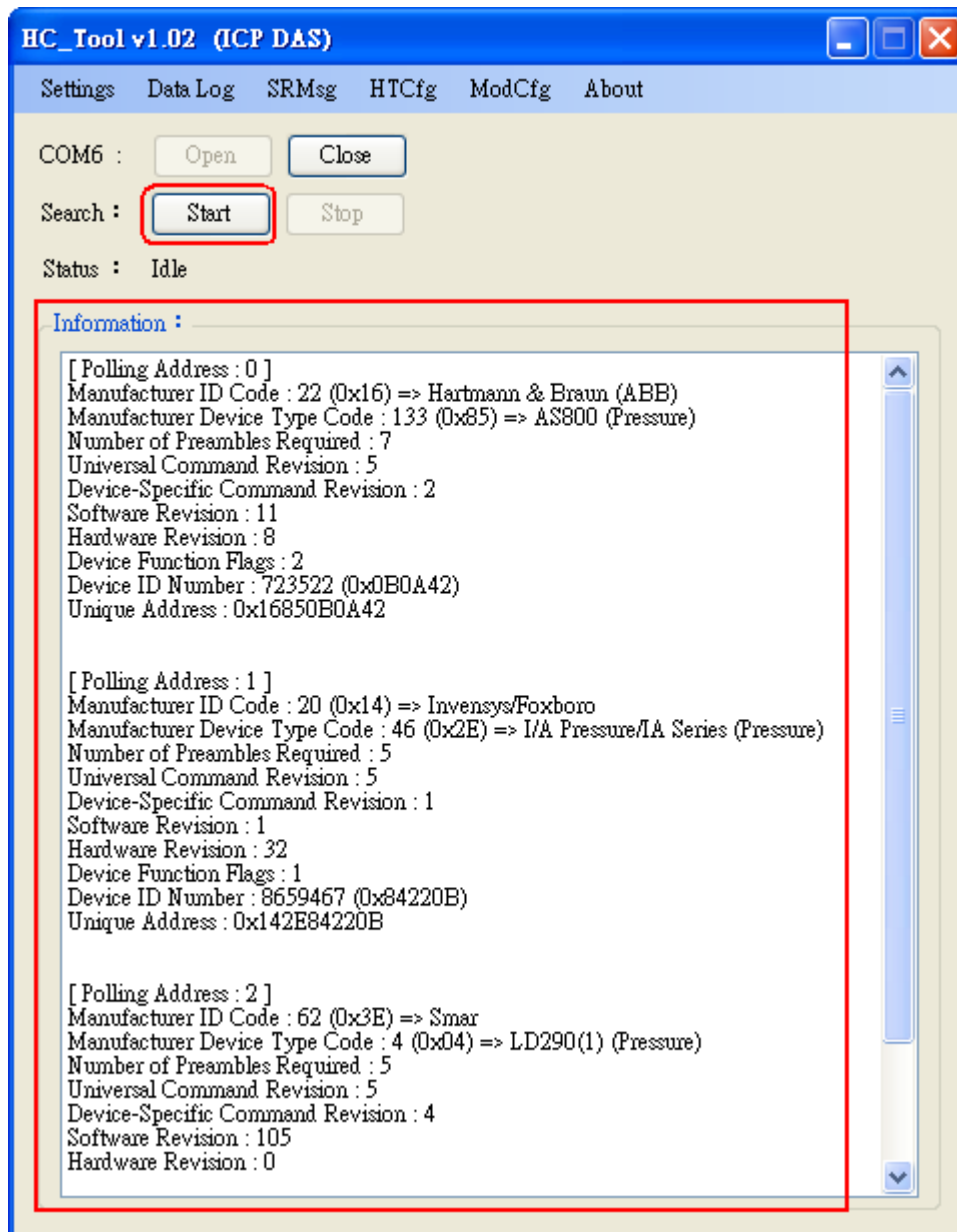

Figure 4-8: HART device Information

If the error message - “Search Device Failed !!” shows like Figure 4-9, please check HART network status and HART command format.

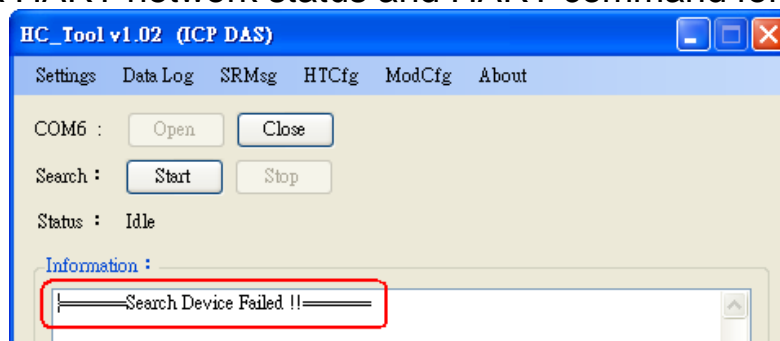

Figure 4-9: Search Device Failed

4.5 Send / Receive HART Frame (SRMsg)

- (1) Click “**SRMsg**” menu and it will open the HART command function window for HART communication like Figure 4-10.

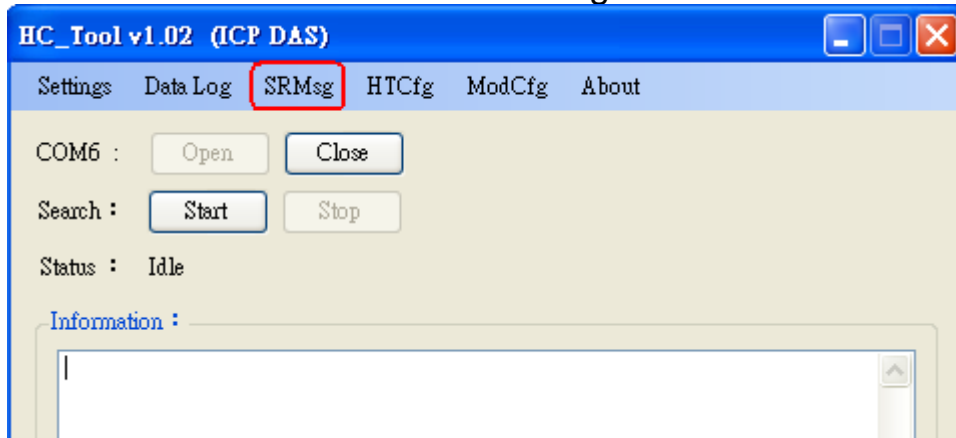

Figure 4-10: SRMsg Function

- (2) Please type the HART command in the “Send Data” field and click “Send” button to send out the HART command like Figure 4-11.

[1] “**With Parity Check**” item :

When check the item, it will add the “check byte” automatically while sending the HART frame.

[2] “**Auto Scroll**” item :

When check the item, it will scroll the HART message field automatically to show the latest HART message information.

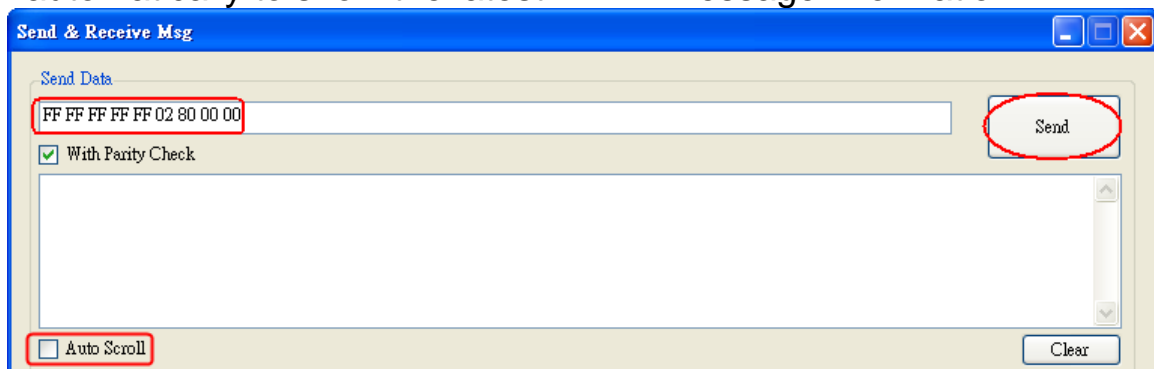

Figure 4-11: Send HART Command

- (3) When HART device responses the HART information, it will show in the “Receive Data” field like Figure 4-12. If error happened in HART communication, it will not show any message in the “Receive Data” field. Please check the HART command in the “Send Data” field if it is correct.

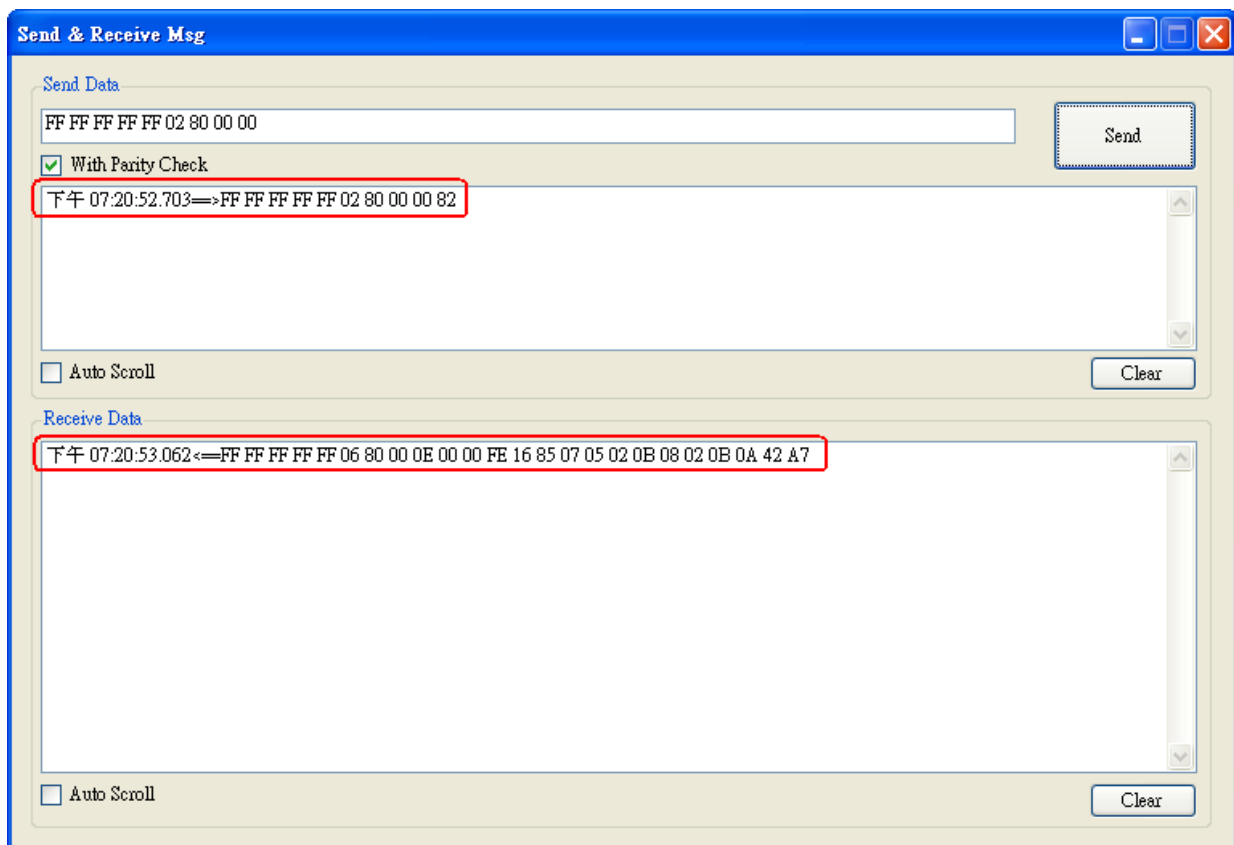

Figure 4-12: Receive HART Command

4.6 HART Information Log (Data Log)

When using "SRMsg" or "Start" function for HART communication, all the HART command information will be logged in the "Data Log" function. Users can click "Data Log" item and all the HART communication information will be shown in "Log" field like Figure 4-13.

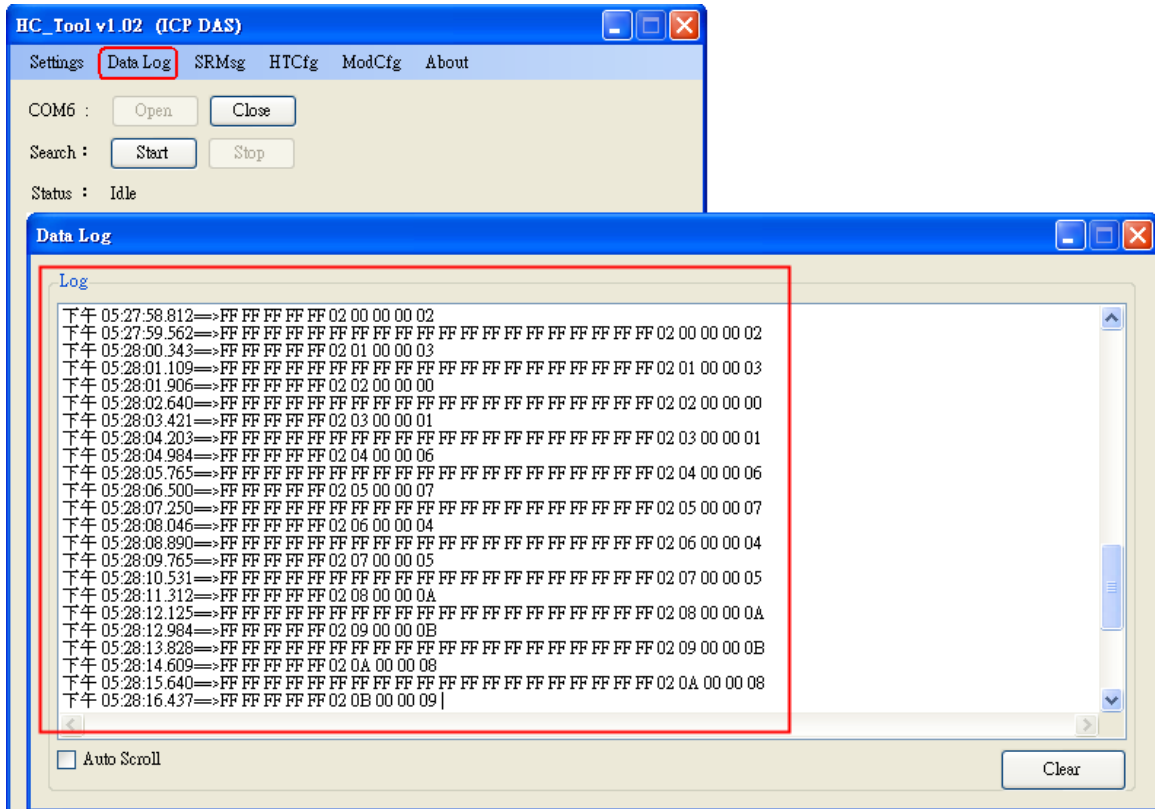

Figure 4-13: HART Information Log

4.7 HART Configuration (HTCfg)

When HART devices are searched in HC_Tool, then users can use “HTCfg” function to configure HART devices like Figure 4-14.

(Supported by HC_Tool v1.02 or newer)

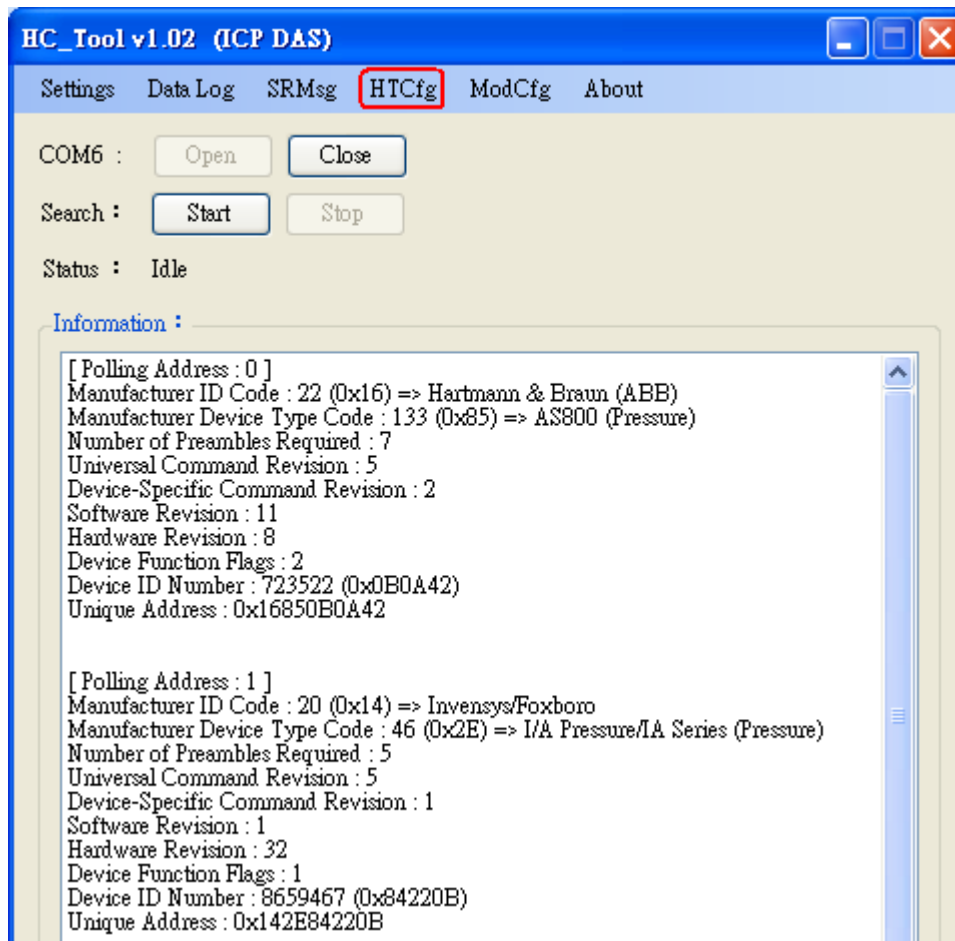

Figure 4-14: HTCcfg Item

The following are the function descriptions of “HTCcfg” screen. (Like Figure 4-15)

- (1) “**DevAddr**” Field: Assign the HART device for configuration.
- (2) “**Response**” Field: Show the response message of HART configuration command.
- (3) “**Universal**” Page: Choose the “Universal” command for configuration.
([Support HART Command version v6.0](#))
- (4) “**Common**” Page: Choose the “Common-Practice” for configuration.
([Support HART Command version v6.0](#))
- (5) “**Start**” Button: Trig to send the HART configuration command.
- (6) “**Listen Mode**” item: Check it and click the “Start” button, HC_Tool will listen HART bus and show the received HART message information.
- (7) “**HART RecvMsg Count**” Area: Show the total count of the received HART messages. (Including Master sending message and Slave response message)

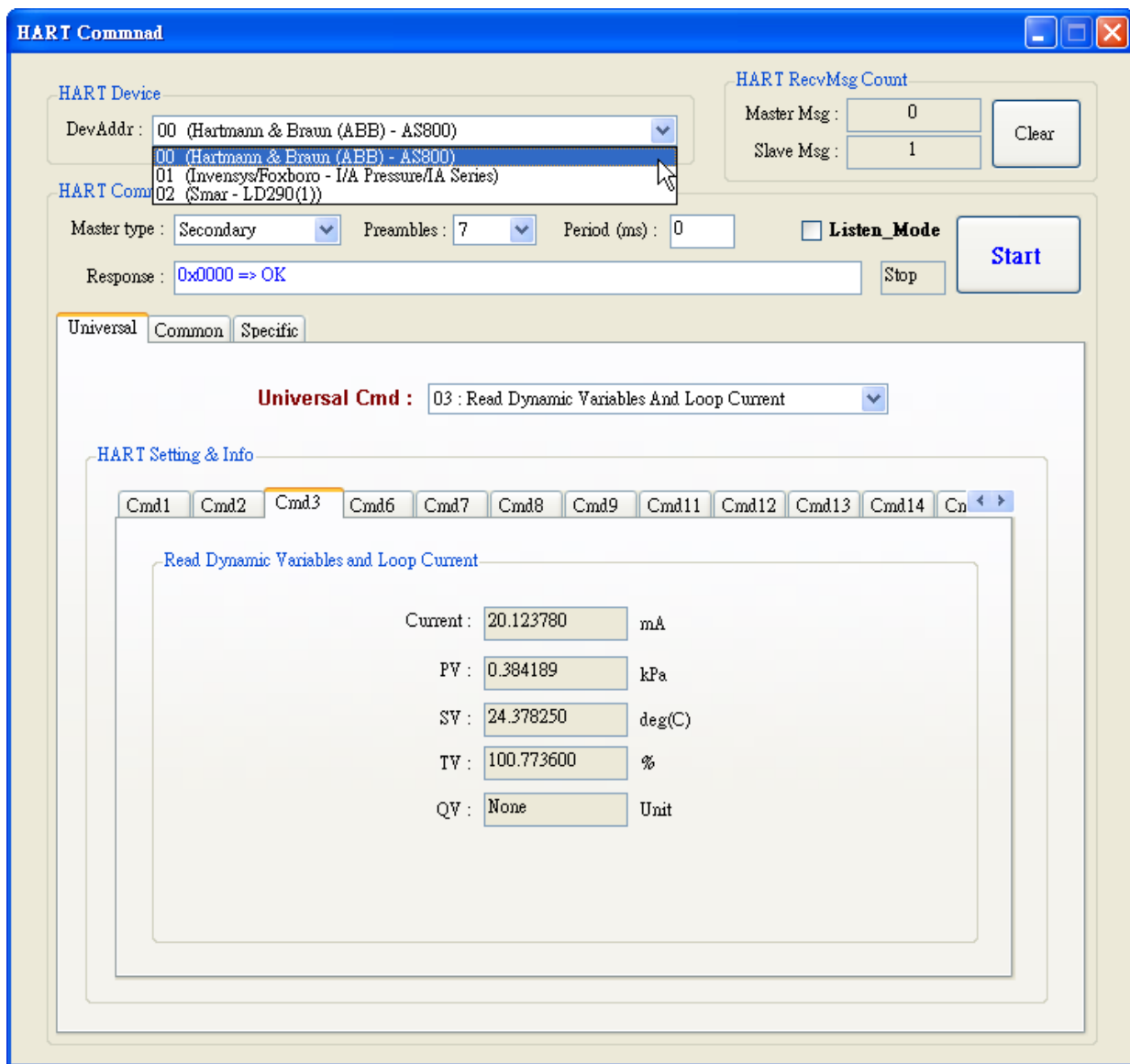

Figure 4-15: HTCfg Screen

4.8 Module Configuration (ModCfg)

Click “**ModCfg**” item, it will show the below two options to open the module configuration screen of HART Converter like Figure 4-16.

- (1) HC_Tool : v1.02 or newer supported.
- (2) I-7567 : FW_v1.5 or newer supported.
- (3) I-7570 : FW_v1.4 or newer supported

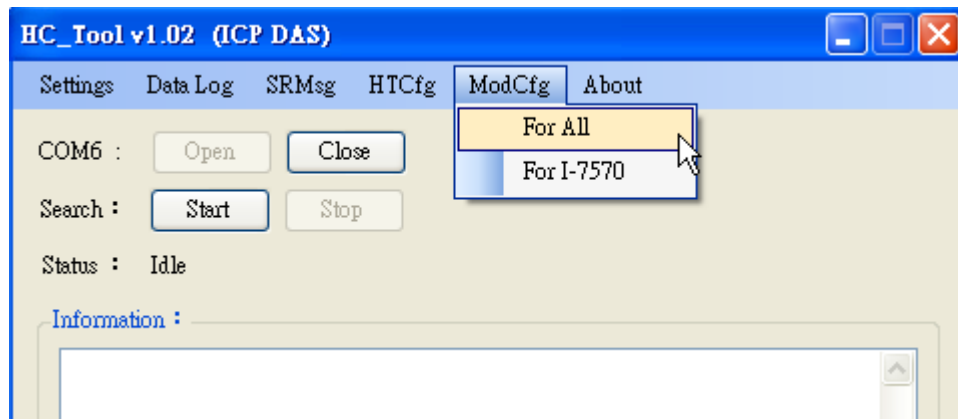

Figure 4-16: ModCfg Item

The following is the function description of “ModCfg”.

1. “For All” Option : (Like Figure 4-17)

Note : It is used for all HART Converter modules

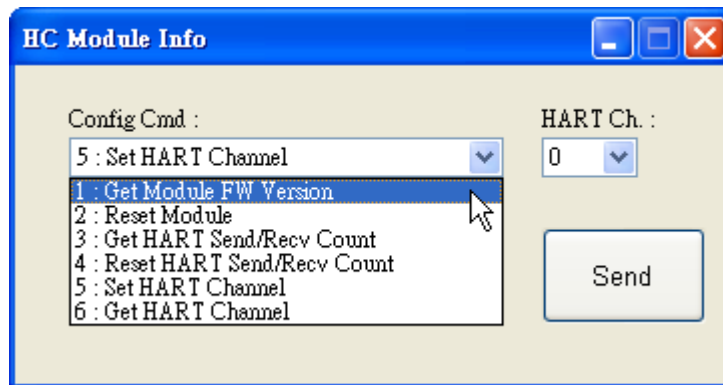

Figure 4-17: “For All” Option - Configuration Screen

(1) “Get Module FW Version”:

=> Return the firmware version of HART converter module.

(2) “Reset Module”:

=> Reset HART converter module.

(3) “Get HART Send/Recv Count”:

=> Return the total count of the sending and receiving HART messages in HART converter module.

(4) “Reset HART Send/Recv Count”:

=> Reset the total count of the sending and receiving HART messages in HART converter module.

(5) “Set HART Channel”: (Only for I-7547)

=> Set the HART channel (Range: 0 ~ 3) of I-7547 for HART communication by using “HART Ch” option.

Users can also set the HART channel by send com port command.

For example:

Send Command => **#C52\r** (Set HART channel to be 2)

Return Data => **!C5\r** (Success)

Return Data => **?02\r** (Failure)

[Note]

1. Only one HART channel in I-7547 can be used to communicate with HART device in the same time.

(6) “Get HART Channel”: (Only for I-7547)

=> Return the current HART communication channel (Range: 0 ~ 3) of I-7547.

Users can also get the HART channel by send com port command.

For example:

Send Command => **#C6\r**

Return Data => **!C6_2\r** (The current HART channel is 2.)

2. “For I-7570” Option : (Like Figure 4-18)

Note : It is just used to I-7570 module and make sure the I-7570 must run in “Config Mode” first.

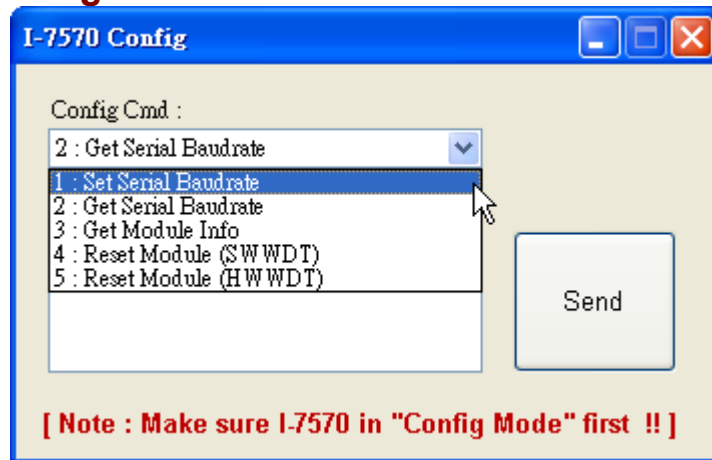

Figure 4-18: “For I-7570” Option - Configuration Screen

5. FAQ

Q01 : How to use I-7547 to communicate with HART devices ?

A01:

1. Install “VxComm” utility to create the virtual com port. (refer to section 4.1)
2. Run “HC_Tool” utility to communicate with HART devices. (refer to section 4.2~4.7)

Q02 : Does I-7547 support the Pair-Connection for HART ?

A02:

Yes, please refer the below steps. (It needs two I-7547 modules for Pair-Connection)

1. Log in the web setting page of I-7547. (refer to section 3.1)
2. Set the pair-connection parameters for these two I-7547s.
(Note: One should be set for server and the other will be client. (refer to section 3.7))
3. Connect the Ethernet port of these two I-7547 modules in the same network.

Q03 : Does I-7547 support HART OPC Server from HCF?

A03:

1. Not yet. Because of the timeout setting value is too short in the HART OPC Server and it does not provide any field for timeout value setting in it.
2. The other HART converters of ICP DAS (like: I-7567 / I-7570) can work well without any problem.

Q04 : Set HART device address by using HART converter ?

A04: (2016/03/17)

Please follow the steps below.

- (1) Just connect one HART device to one HART converter (like : I-7567 / I-7570 / I-7547).
- (2) Run “HC_Tool” software.
 - [1] Open the ComPort ◦
 - [2] Click the “Start” button to search HART device automatically. As the figure below, the original address of the HART device is 0.

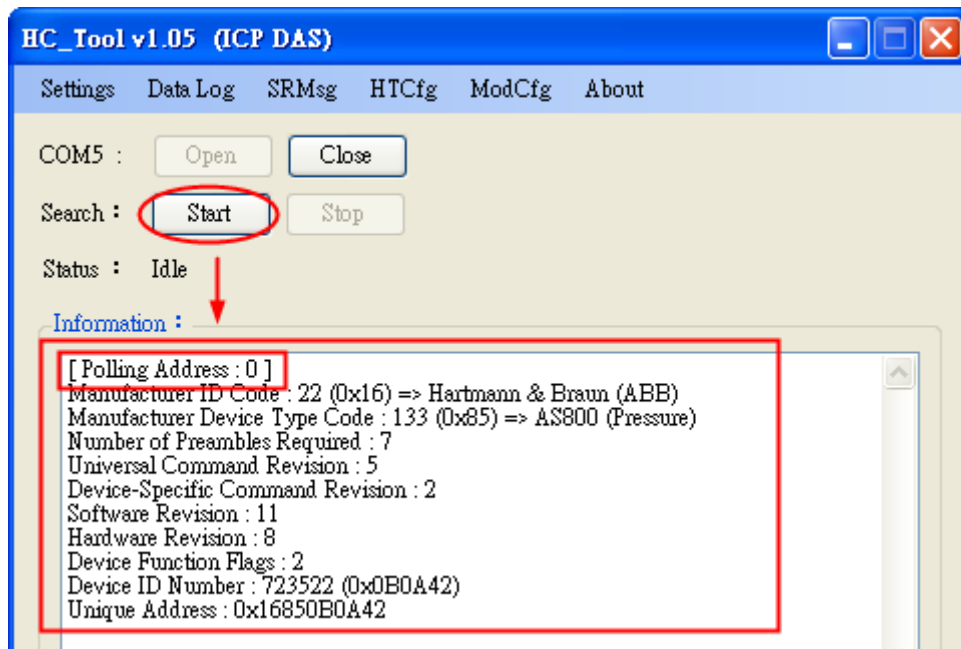

[3] Click the “HTCfg” button to open HART configuration page.

[4] Choose the “HART device” for configuration. In the “Universal” page, click the “Cmd6” option and users can choose the new address of HART device (Example : set to 1). Then click the “Start” button to set the new address.

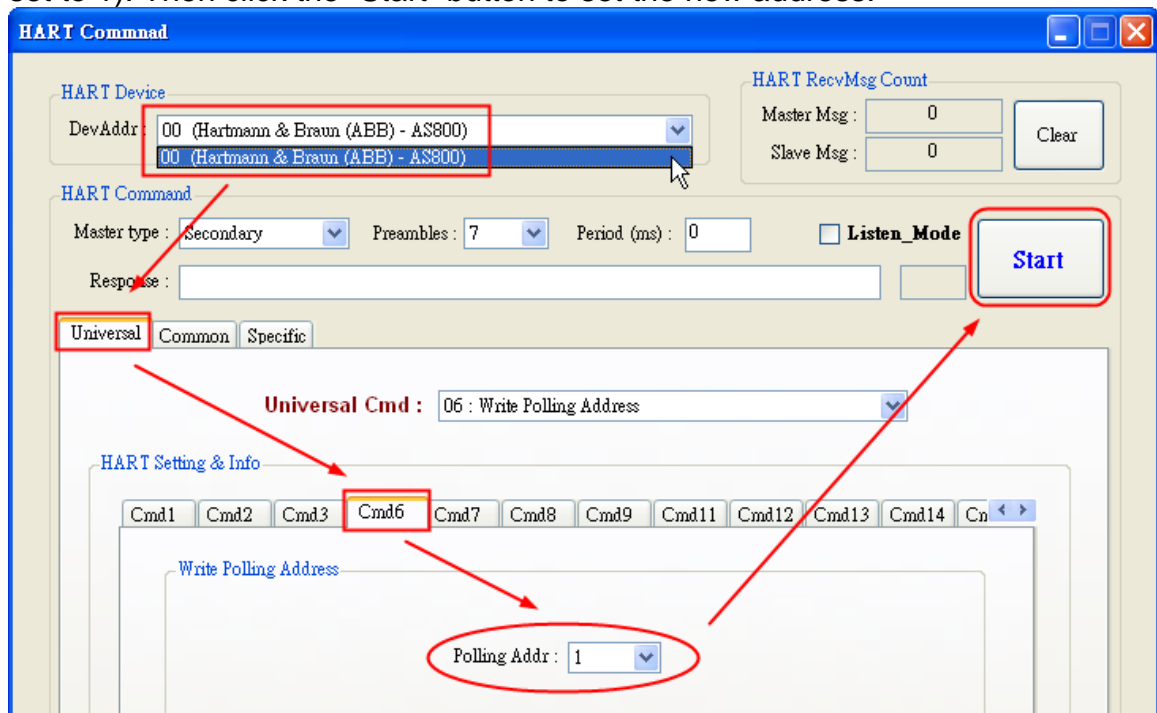

[5] After the setting for the new address is successful, the below message will show.



[6] Click the “Start” button in the main page to search HART device again. Then the address of the HART device will be 1 as the below figure.

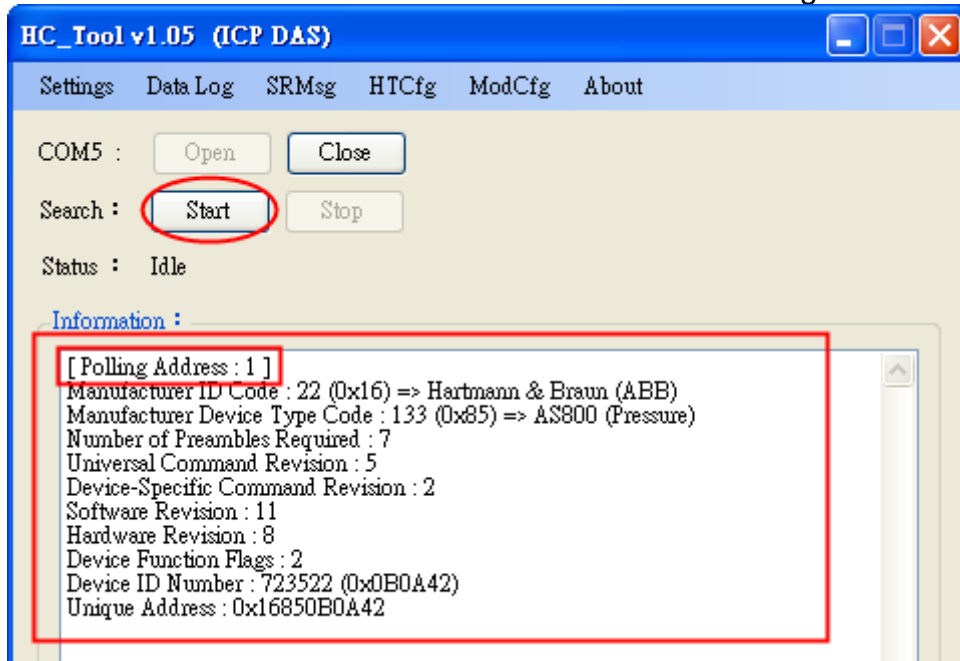

Q05 :How to send HART command for writing (Ex: CMD51)?

A05: (2017/04/05)

Please follow the steps below.

- (1) Just connect one HART device to I-7547
- (2) Run “HC_Tool” software.
 - [1] Open the ComPort ◦
 - [2] Click the “Start” button to search HART device automatically.
 - [3] Click the “HTCfg” button to open HART configuration page.

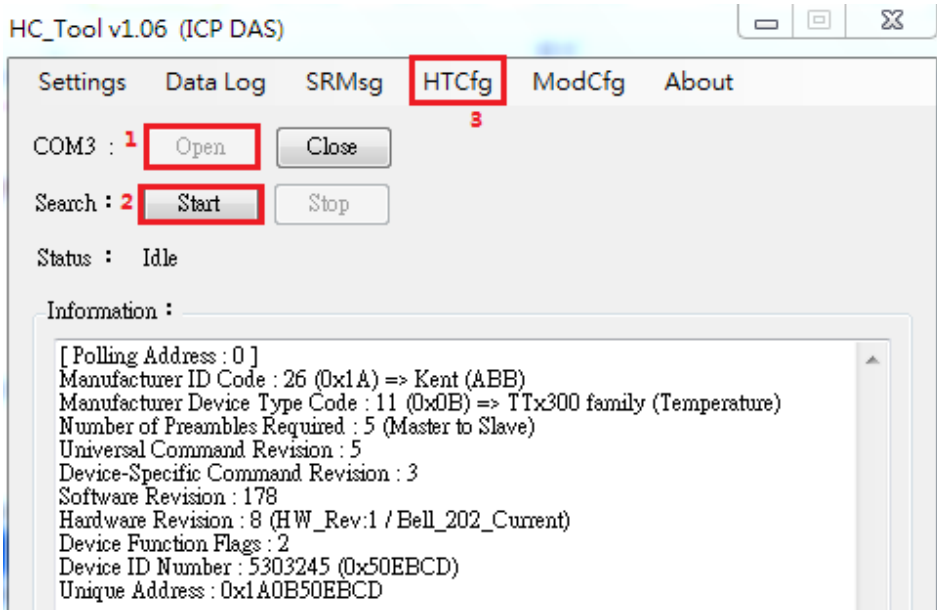

[4] Choose the “HART device” for configuration. In the “Common” tab, select no.51 from the “Common-Practice Cmd” dropdown menu and users can enter dynamic variable assignments. Then click the “Start” button and check the responses.

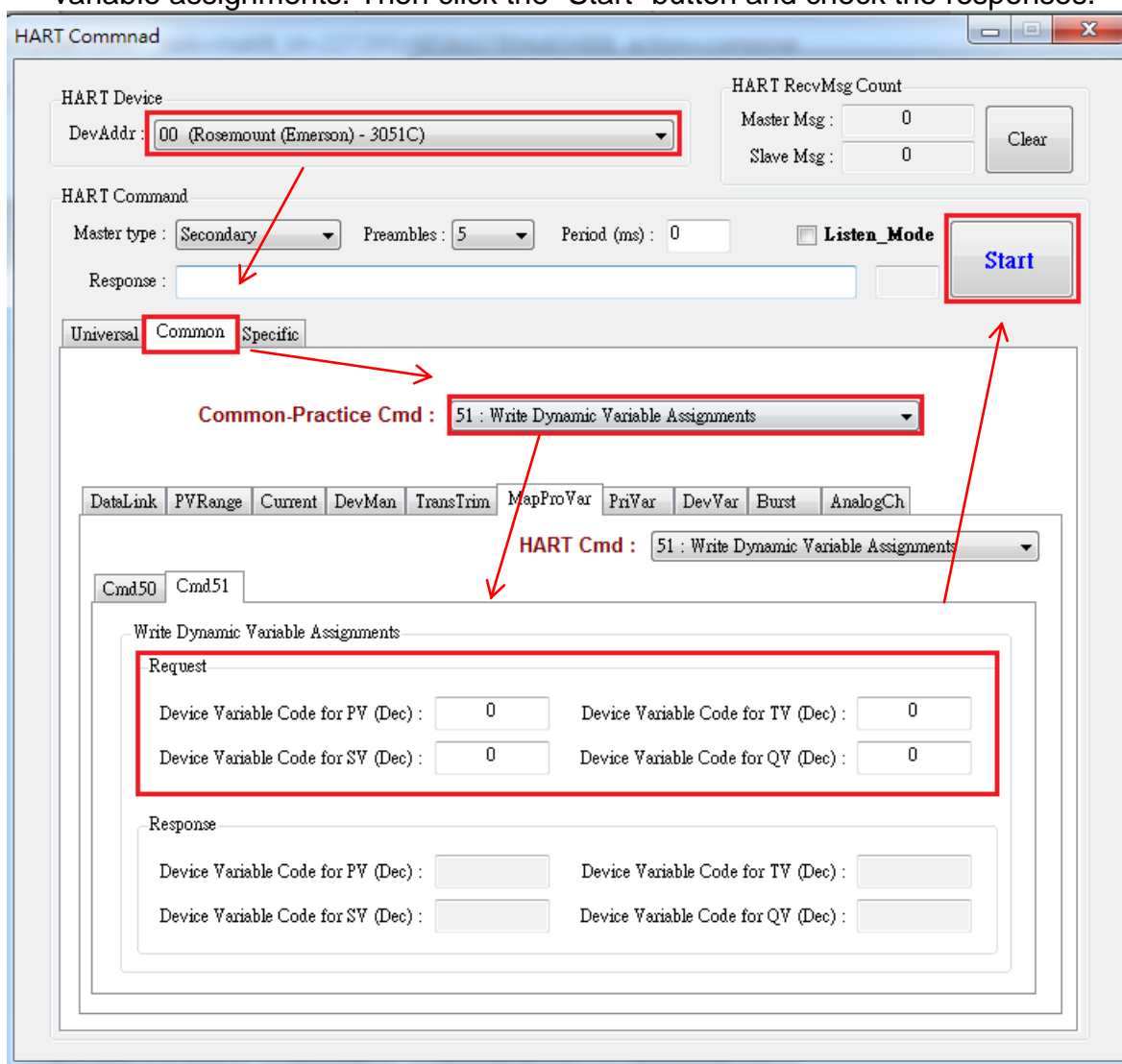

Q06: How to connect with HART OPC server?

A06: (2017/06/22)

I-7567 or I-7570 is highly recommended to be used for HART OPC server connection.

HART OPC server provided by HCF can be downloaded from the following link:

<https://fieldcommgroup.org/hart-server>

After installation finished, open the OPC server and follow the steps below:

(1) Right click the HARTServer icon and choose Add Network

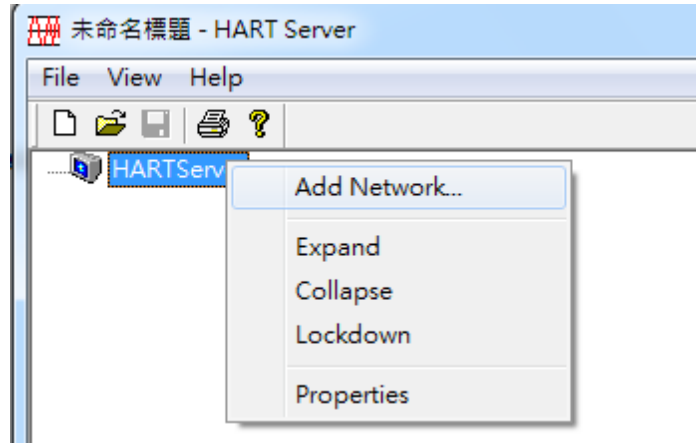

(2) Choose Single Serial Port option

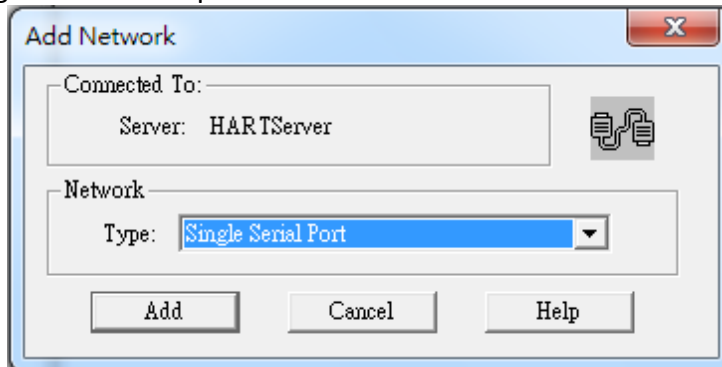

(3) Open COM Port

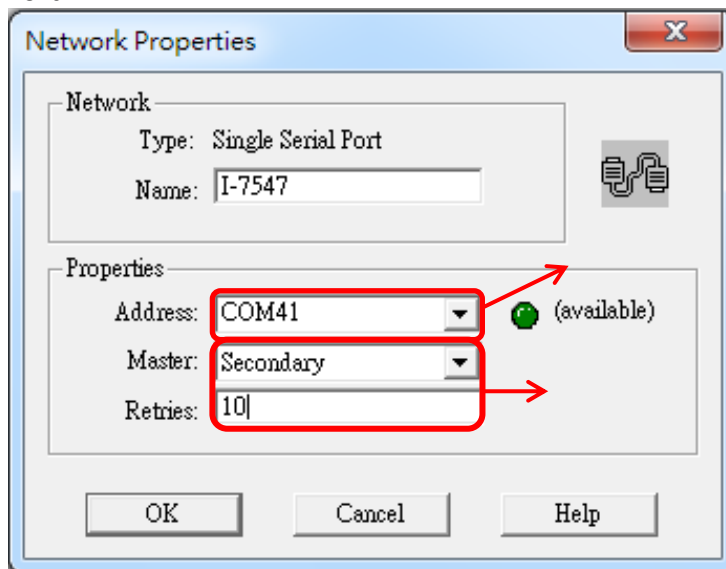

- (4) After module added to the server successful, right click on the module icon and choose Add Device

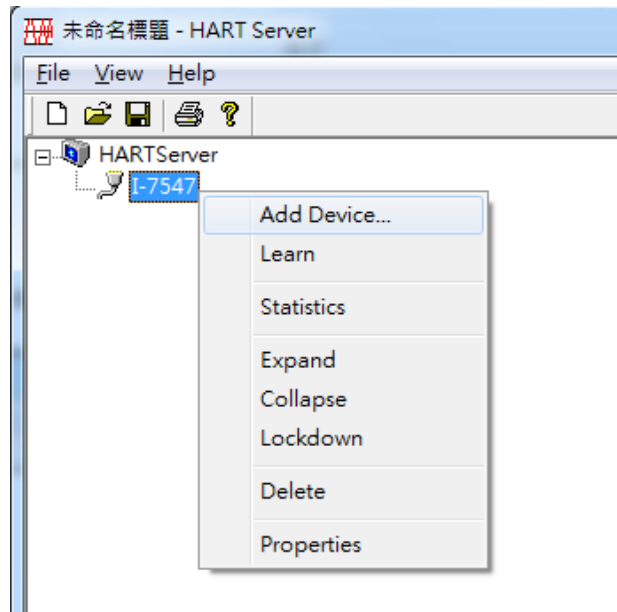

- (5) Choose polling address, and click OK for Instrument Properties window

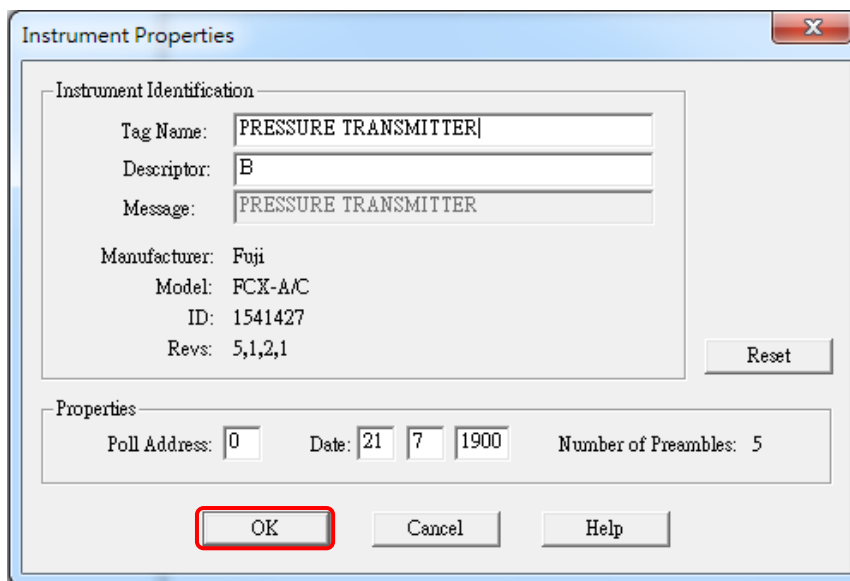
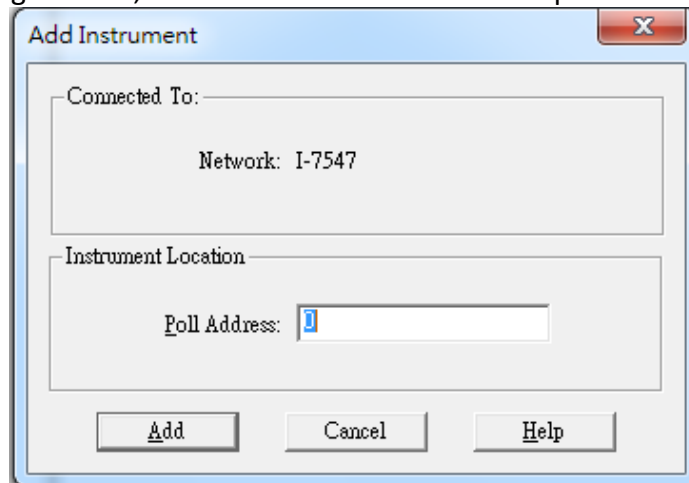

(6) Check device data: double click on the device icon added

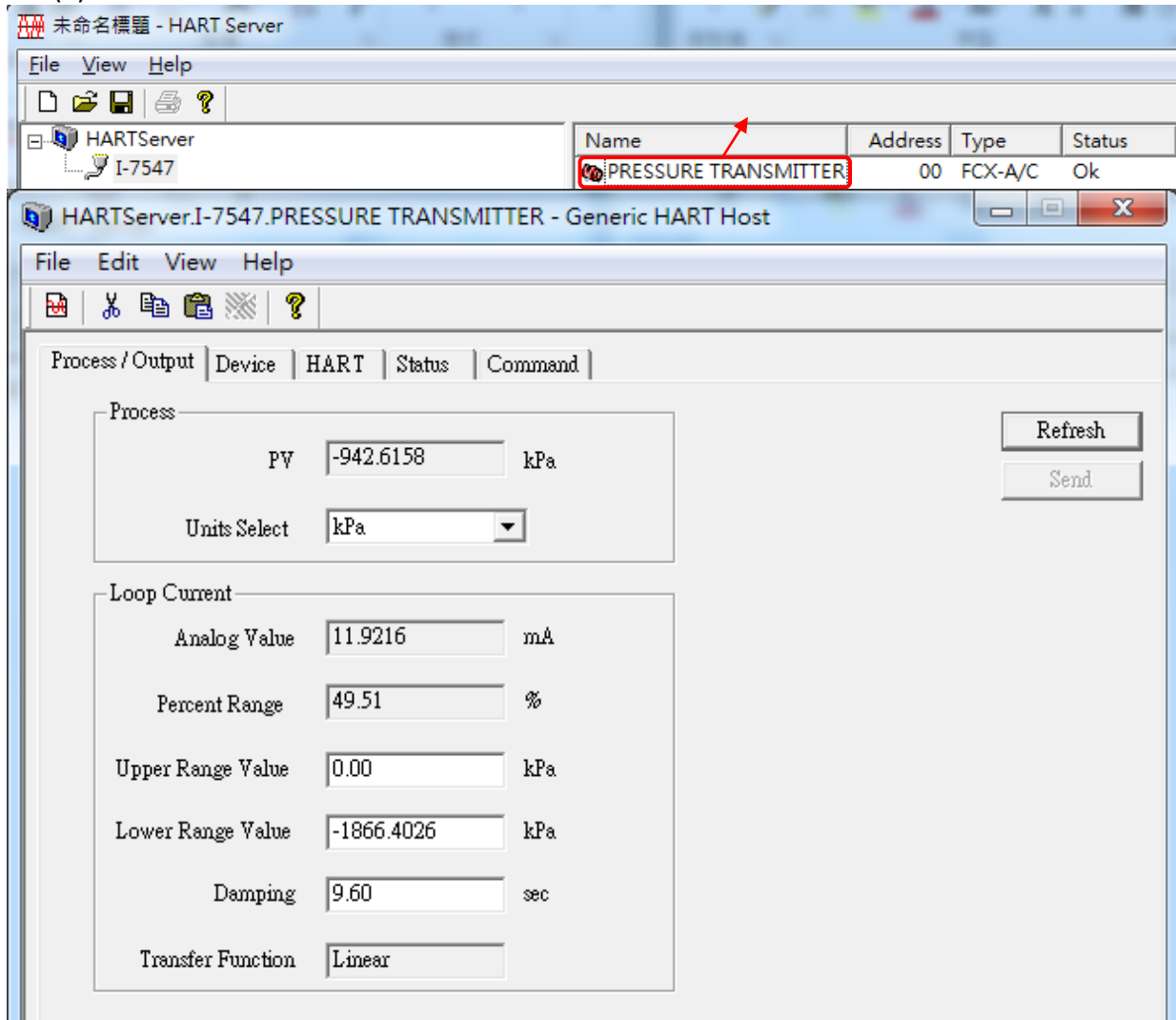

Note: Because of I-7547's efficiency, module no response happens sometimes. I-7567/ I-7570 is recommended to be used which both have been tested to work properly with.

Q07 : How to connect with HART FDT software?

A07: (2018/11/27)

ICP DAS converter can be used with FDT software. The following introduces 3 different FDT software and connection instruction.

(1) PACTware

[1] Add HART communication DTM (ComPort)

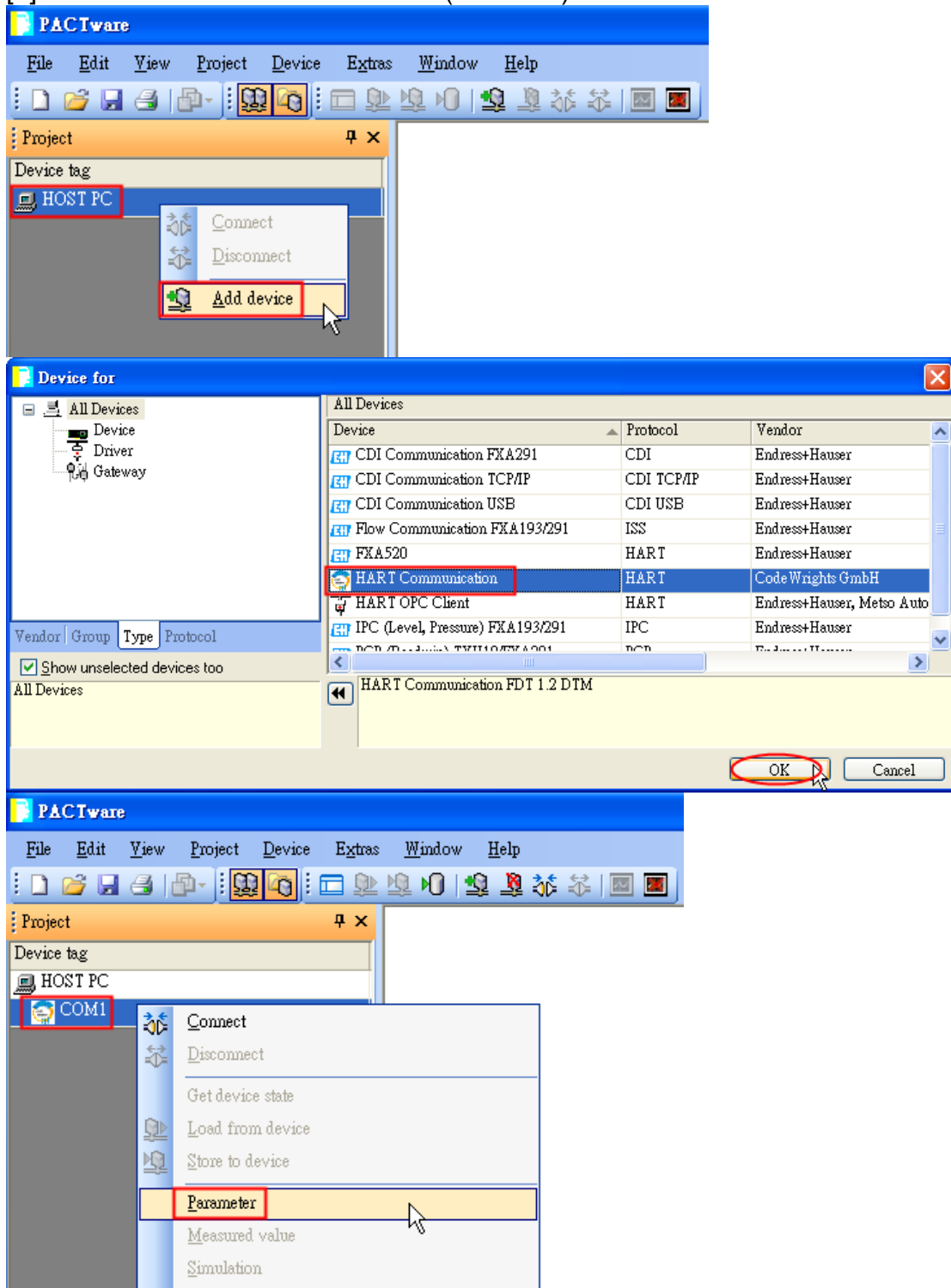

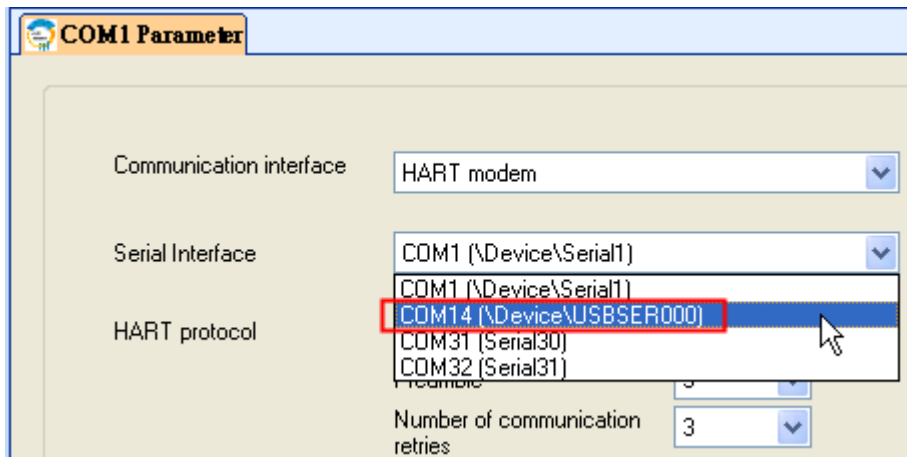

[2] Add HART Device DTM (Generic HART DTM)

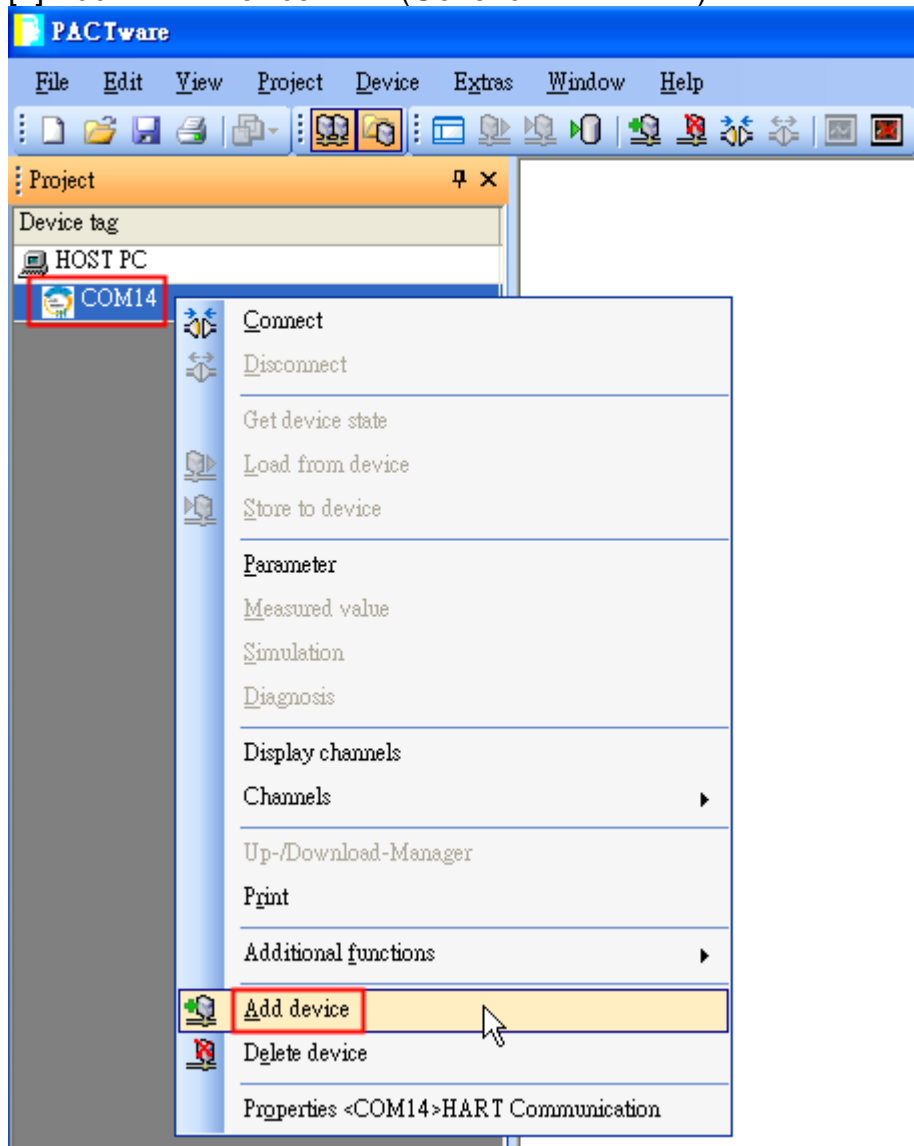

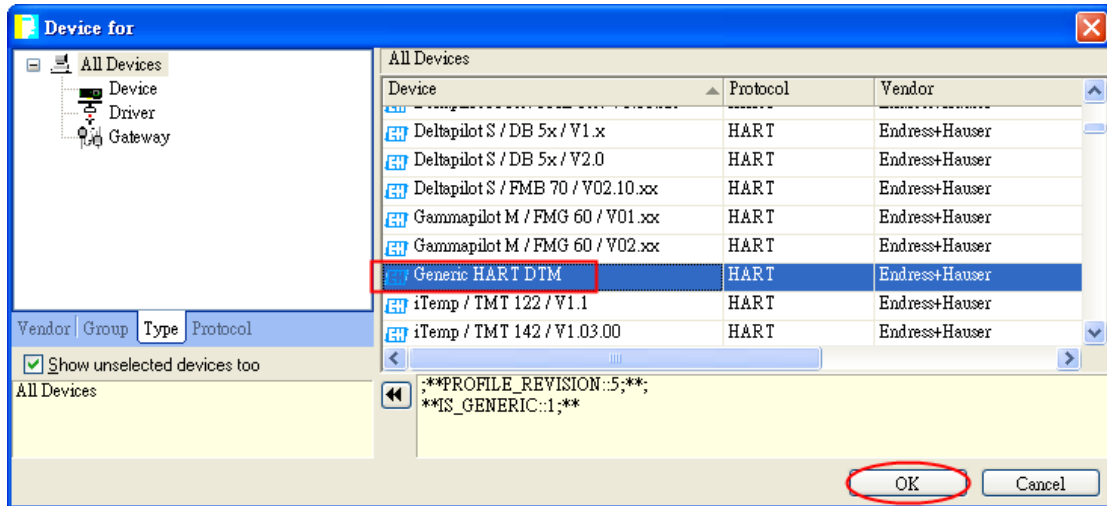

[3] Connect to HART device and show HART information

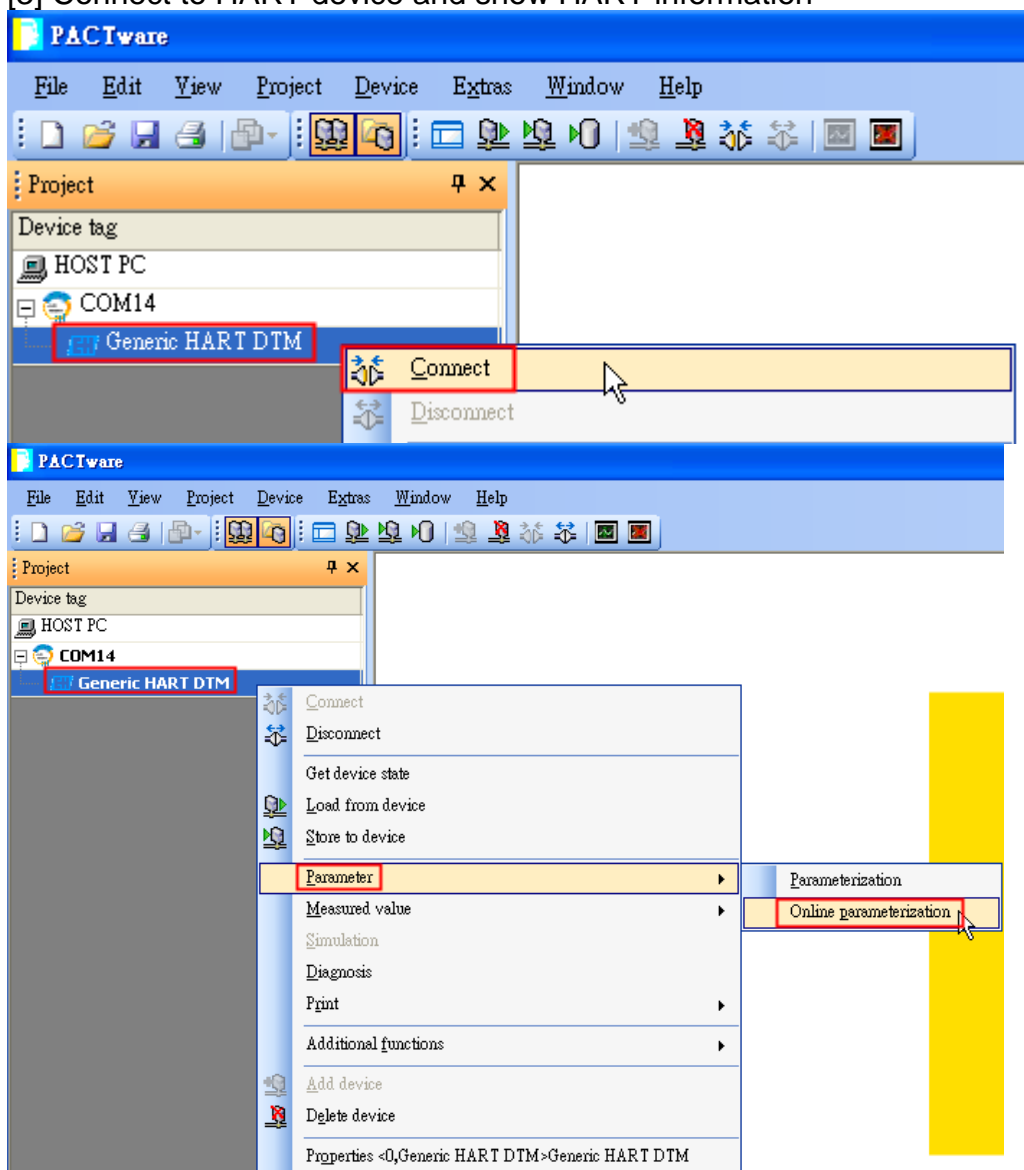

Generic HART DTM # Online parameterization

HART
COMMUNICATION FOUNDATION

0
Generic HART DTM

Generic HART DTM 0.0
0.38766 [kPa]

Offline-Parameterize
Online-Parameterize
Archive
Measured Values Display
Diagnosis
Calibrate device...

Sensor range

URV 0.2313843 kPa
LRV -19.50043 kPa
Unit kPa

Current output

Damping Value 0.25 s
Current alarm High

Generic HART DTM # Online parameterization

HART
COMMUNICATION FOUNDATION

0
Generic HART DTM

Generic HART DTM 0.0
0.38783 [kPa]

Offline-Parameterize
Online-Parameterize
Archive
Measured Values Display
Diagnosis
Calibrate device...

Endress+Hauser
People for Process Automation

PV [kPa] SV [°C] TV [%] QV [unknown]

Current [mA]

Archive
 PV
 Current
 SV
 TV
 QV
 Recording

Data state
Connected
 Cyclic Refresh
 Cycle Time 5 s
 Professional

9:39:45 9:40:00 9:40:15 9:40:30 9:40:45 9:41:00 9:41:15 9:41:30
9/10/2013 9 39 33 9/10/2013 9 41 33

Generic HART DTM # Online parameterization

HART
COMMUNICATION FOUNDATION

0
Generic HART DTM

Generic HART DTM 0.0
0.38758 [kPa]

Offline-Parameterize
Online-Parameterize
Archive
Measured Values Display
Diagnosis
Calibrate device...

Endress+Hauser
People for Process Automation

PV 0.3875781 kPa
Current 20.12672 mA
SV 27.29742 °C
TV 100.792 %
QV unknown

0 100 200 300 400 500 600 700 800 900 1000

0 5 10 15 20

0 100 200 300 400 500 600 700 800 900 1000

0 100 200 300 400 500 600 700 800 900 1000

0 100 200 300 400 500 600 700 800 900 1000

(2) FieldCare

[1] Enabling SQLFIELD CARE

SQL Active Directory Helper Service	Enabl...		已停用	Network S...
SQL Server (MSSQLSERVER)	Provi...	已啓動	自動	本機系統
SQL Server (SQLEXPRESS)	Provi...		手動	Network S...
SQL Server (SQLFIELD CARE)	Provi...	已啓動	手動	本機系統
SQL Server Agent (MSSQLSERVER)	Exec...		已停用	Network S...
SQL Server Agent (SQLEXPRESS)	Exec...		已停用	Network S...
SQL Server Agent (SQLFIELD CARE)	Exec...	已啓動	自動	Network S...
SQL Server Browser	Provi...	已啓動	自動	Local Serv...
SQL Server VSS Writer	Provi...	已啓動	自動	本機系統

[2] Add HART Communication DTM

Connection Wizard

Select the communication protocol and the CommDTM with which you wish to connect to devices!

1. Select the communication protocol:

Protocol
<input checked="" type="checkbox"/> HART
<input type="checkbox"/> SERVICE



2. Select the Communication DTM to be used:

Communication DTM	Communication Hardware	Version	Manufacturer
<input checked="" type="checkbox"/> HART Communication	FXA191; FXA195	1.0.42	CodeWrights GmbH
<input type="checkbox"/> HART OPC Client	-	2.0	Endress+Hauser, Met...
<input type="checkbox"/> FXA520	FieldGate FXA520	1.05.09	Endress+Hauser

Help Next > Cancel

[3] Connect to HART device and show HART information

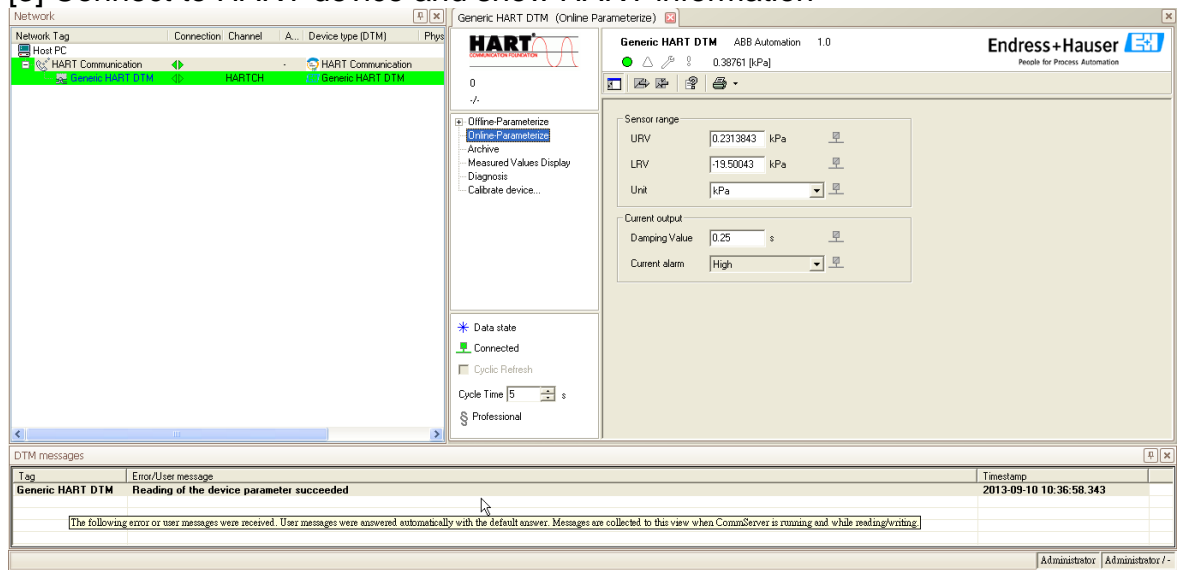

(3) Siemens PDM

[1] Add HART Device DDL (ABB AS-800 as example)

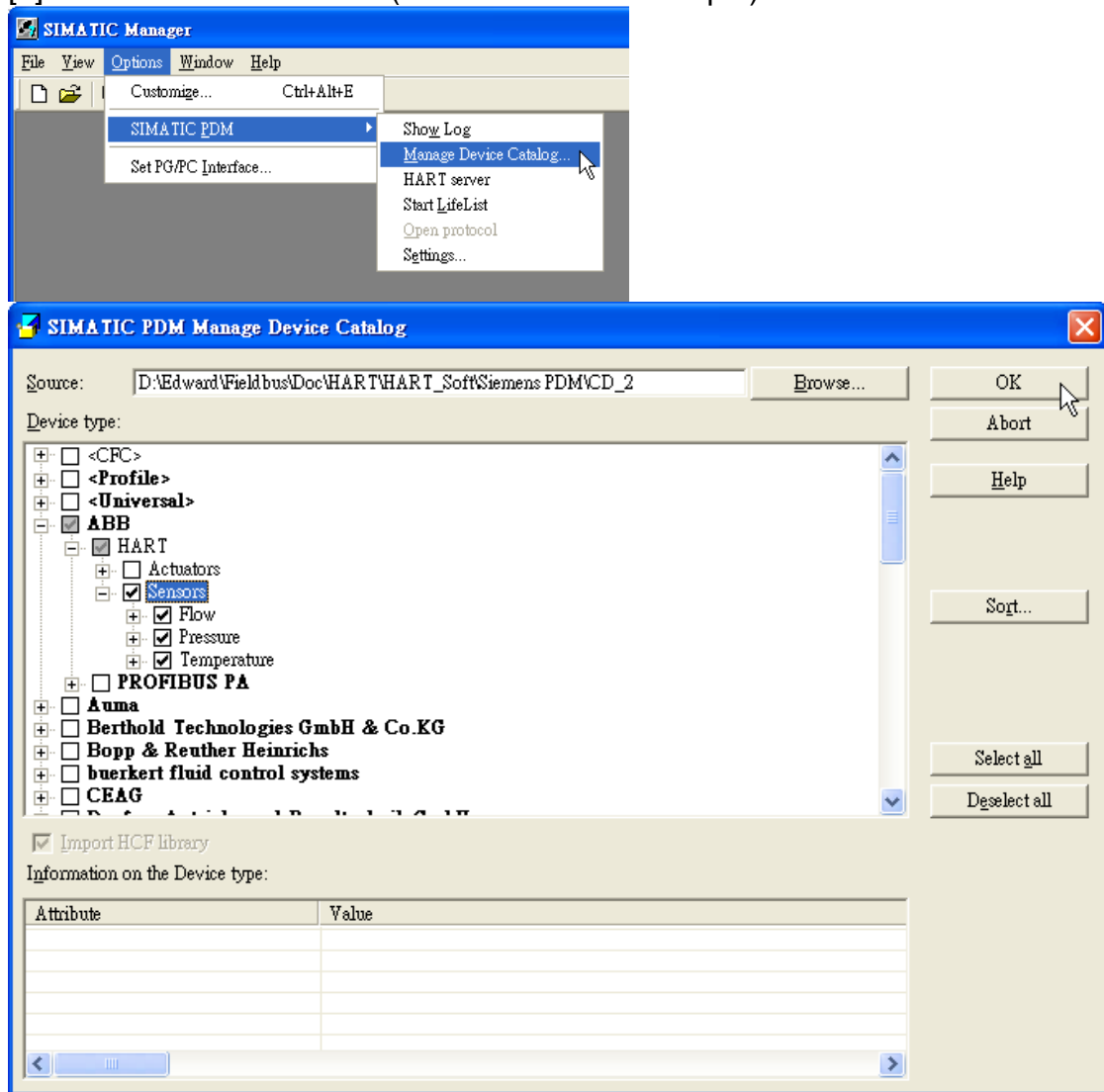

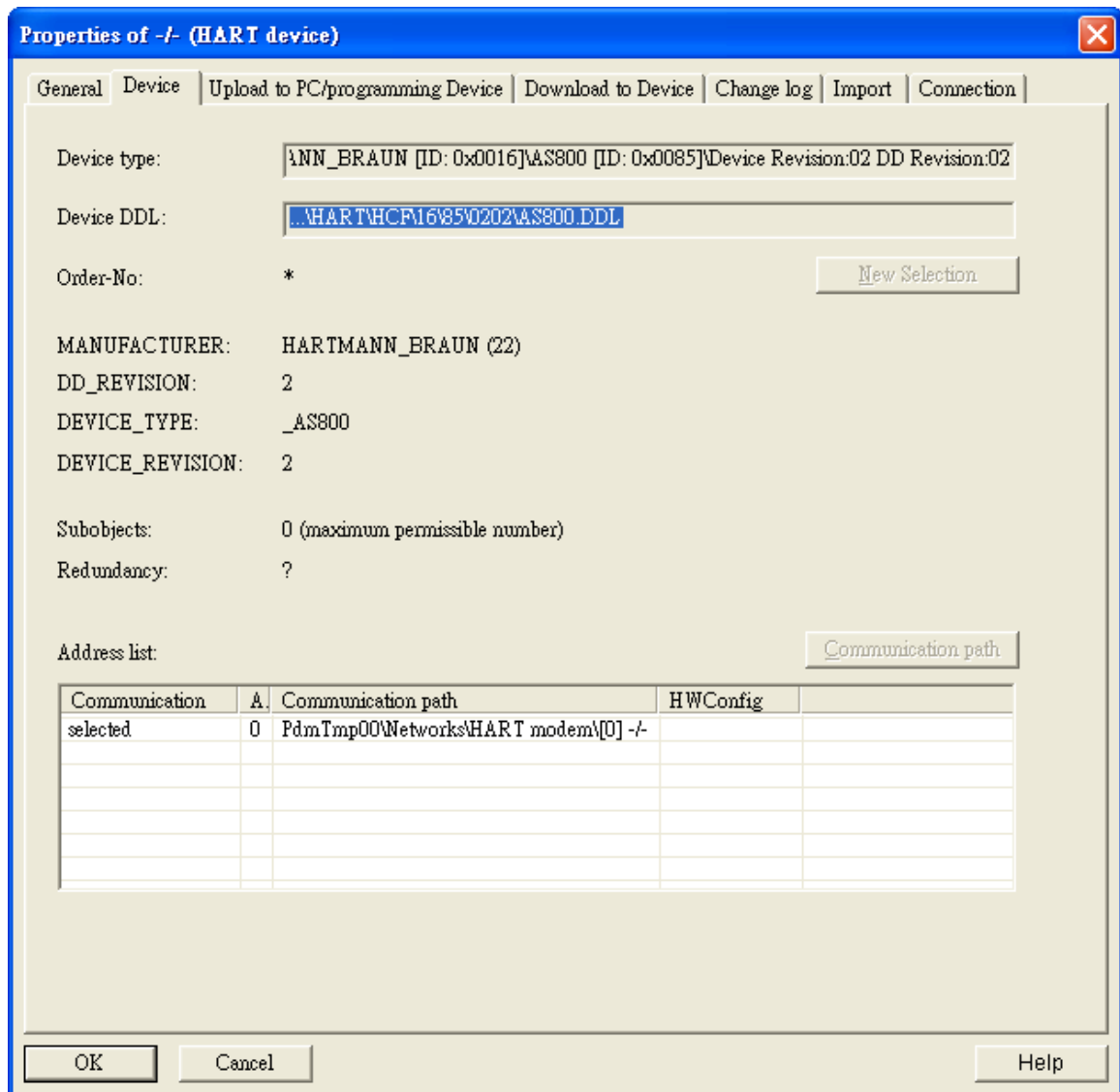

[2] Scan HART Device (ComPort)

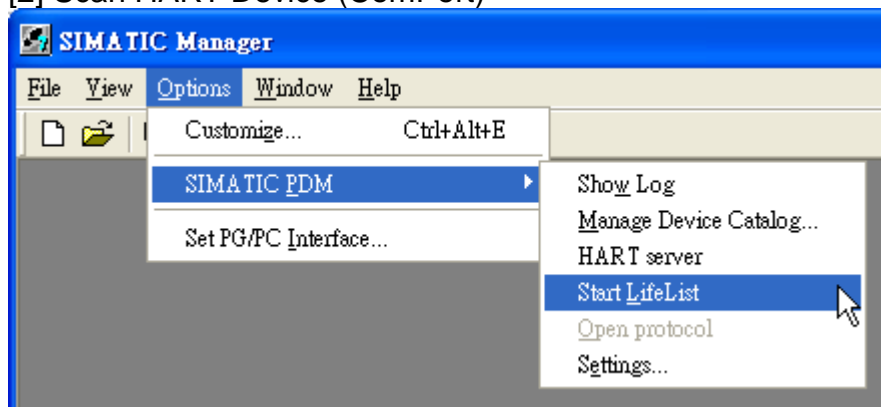

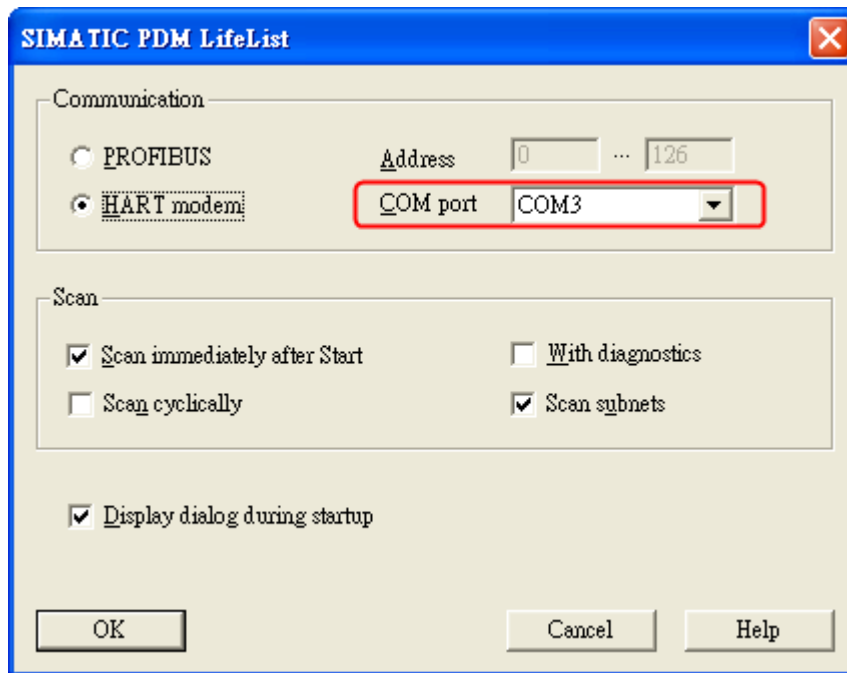

[3] Check HART Device information

SIMATIC PDM - -/- [Temporary project]

File Device View Options Help

Networks

- CHARLIE-80DAC5C
- HART modem
 - /-

Parameter	Value	Unit	Status
Online			
	1	inH2	Initial
Analog outp	1.000	mA	Initial
LRV	1	inH2	Initial
URV	1	inH2	Initial
Version	1.1	Englis	Initial
» Device setup			
» » Process variables			
	1	inH2	Initial
% mng	1.0	%	Initial
Analog outp	1.000	mA	Initial
	1.0	deg	Initial
TV Value	1.00e	inH2	Initial
» » Diag/Service			
» » » Test device			
» » » » Status			
Status grou			Initial
Status grou			Initial
» » » Calibration			
» » Basic setup			
Tag	-/-		
Unit	inH20		Initial
Xfer fnctn	Linear		Initial
Damp	1.000	s	Initial
» » » Range values			
LSL	1.00	inH2	Initial
USL	1.00	inH2	Initial
LRV	1	inH2	Initial
URV	1	inH2	Initial
Unit	inH20		Initial
» » » Device information			
Distributor	Acrom		Initial

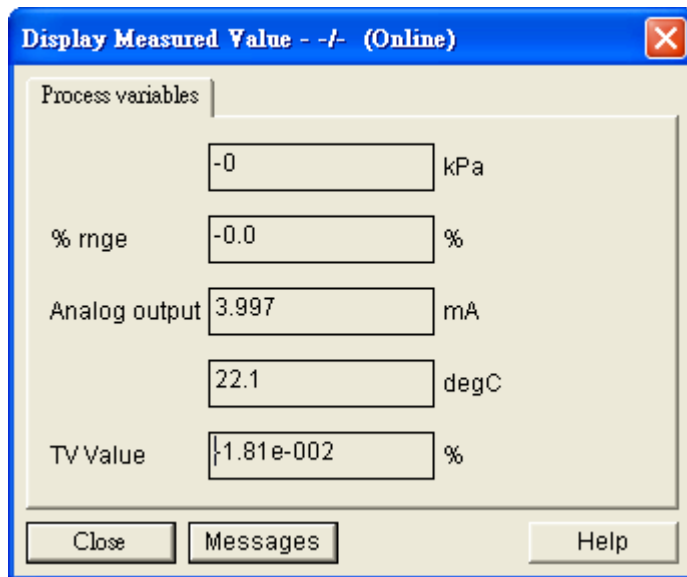

Q08 : How to listen HART network communication by HART converter

converter

A08: (2019/02/14)

HART converter is a good tool for analyzing and debugging HART network communication. To do so, please follow the instruction below:

Hardware:

ICP DAS HART converter *1

Software:

HC_Tool

Download from: ftp://ftp.icpdas.com.tw/pub/cd/fieldbus_cd/hart/converter/i-7547/software/

Steps:

1. Add HART converter to the existing HART network.

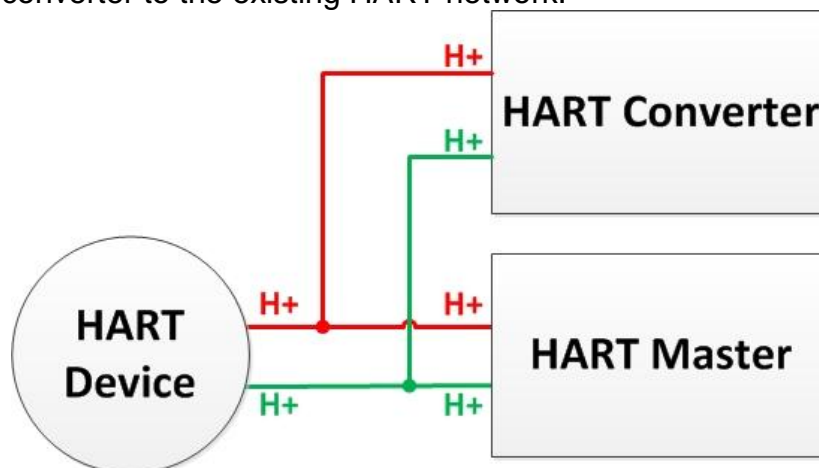

2. Make sure the loop resistance is $250\ \Omega$, if HART converter's built-in resistor needs to turn off, please refer to section 2.2 of Terminator Resistor Settings.
3. Use HC_Tool to record HART communication frames

(1) Simple data logging (does not affect existing communication)

[1] "Open" Com Port and click the "Data Log" button

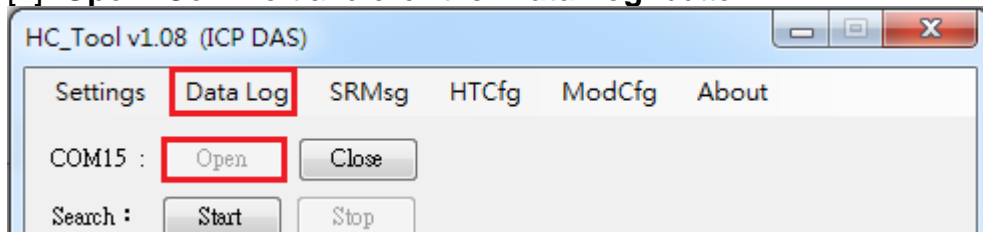

[2] Click the "Start Record" button to record communication frames, and click "Stop Record" to end



(2) Listen mode analysis data logging (may affect existing communication)

[1] “Open” Com Port and “Start” searching HART network device

[2] After finish searching device, click “HTCfg” button

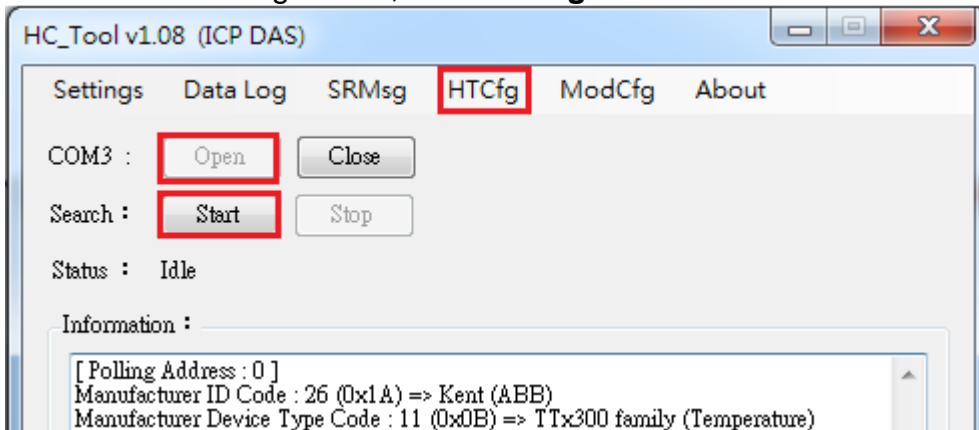

[3] Tick “Listen_Mode” and click the “Start” button

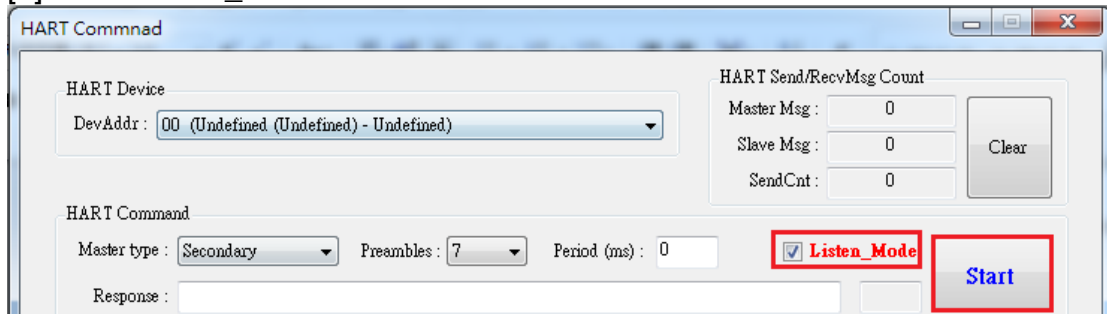

[4] Click the “Data Log” button

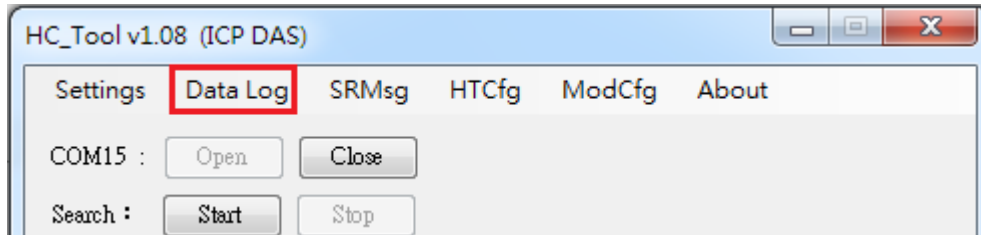

[5] Click the **“Start Record”** button to record communication frames, and click **“Stop Record”** to end

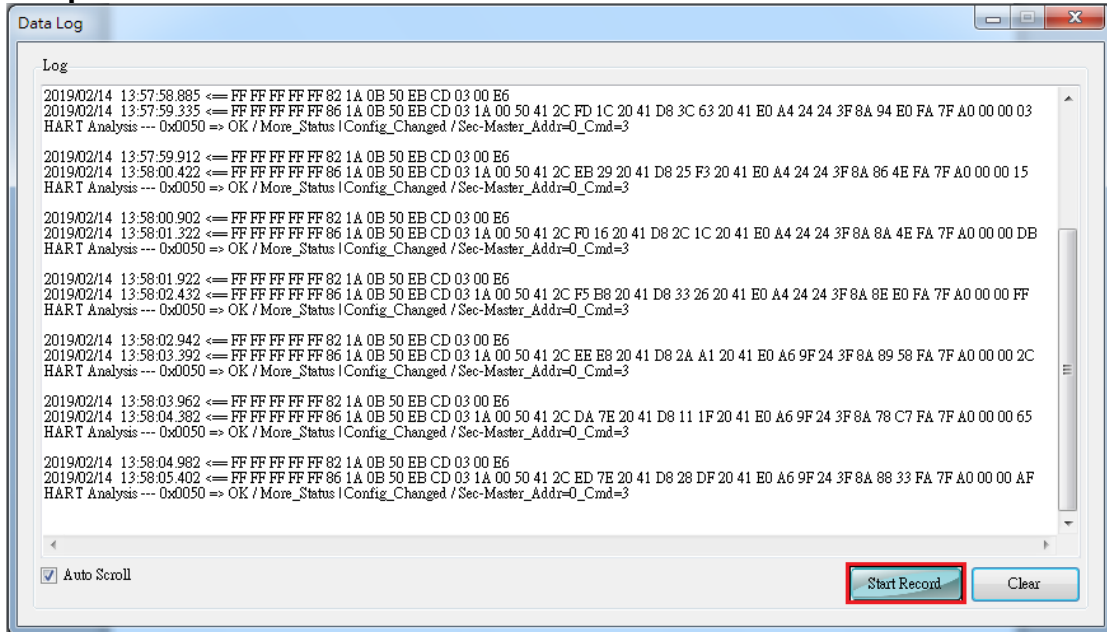

Q101 : How to get the current IP address of I-7547 ?

A101: (2016/04/26)

1. Use the "Search Servers" function in the "VxComm utility" to search I-7547 module automatically and users can get the current IP address of I-7547.
2. If users set the IP type of I-7547 to be "DHCP" and no DHCP server exists in the network, please follow the below steps.
 - (1) Set the dip-switch in the back of I-7547 to be "Init" position and reboot I-7547. Then the default IP of I-7547 will be 192.168.255.1.
 - (2) Use the "Search Servers" function in the "VxComm utility" to search I-7547 module automatically and then users can set the network settings of I-7547 again.

Q102 : How to avoid I-7547 to reset automatically ?

A102: (2019/08/28)

1. The default function of I-7547, when Ethernet of I-7547 without any communication lasts for 300 seconds (5 minutes), I-7547 will reset automatically.
2. If users want to modify the reset time or stop the function, please follow the below steps.
 - (1) Connect to the web of I-7547.
 - (2) Go to the page of "**Network Setting**" and find the "**General Setting**" subject. Then you can adjust the reset time in the "**System Timeout**" field,
 - [1] Default : 300 (300 seconds = 5 minutes)
 - [2] Disable : 0 (Stop the function)
 - [3] Max. : 65535 (655.35 seconds)



I-7547 (Ethernet to HART Converter)

[Home](#) | [Port1](#) | [Port2](#) | **[Network Setting](#)** | [Monitor](#) | [Change Password](#) | [Logout](#)

General Settings

Network	
System Timeout (Network Watchdog)	<input type="text" value="0"/> (30 ~ 65535 seconds, 300=default, 0=disable) Action=Reboot
Web Auto-logout	<input type="text" value="10"/> (1 ~ 255 minutes, 10=default, 0=disable)
CGI Configuration:	<input type="text" value="Enable"/> (Enable/Disable the assign.cgi, Enable=default.)
UDP Alarm	
Alarm IP Address(UDP):	<input type="text" value="255"/> . <input type="text" value="255"/> . <input type="text" value="255"/> . <input type="text" value="255"/>
Alarm Port(UDP):	<input type="text" value="54300"/>
Misc.	
Alias Name:	<input type="text" value="ETH2HART"/> (Max. 18 chars)
UART Watchdog:	Tx: <input type="text" value="0"/> Rx: <input type="text" value="0"/> (30 ~ 65535 seconds, 0=default=disable) Action=Reboot
Debug Message(UDP):	<input type="text" value="20"/> (1 ~ 255 seconds, 20=default, 0=disable)
<input type="button" value="Update Settings"/>	

Q103 : How to write Ethernet program to access HART device data via I-7547

A102: (2019/08/28)

1. In general, we will suggest users to install VxComm Utility (refer to section 4.1) to create the virtual com port of I-7547 and write com port program or use HC_Tool to access HART device data.
2. If users want to write Ethernet program to access HART device data, I-7547 supports to use **IP** and **Port 10002** to do that.
(Demo refers to "I-7547_Ethernet_HART_Demo", download :
ftp://ftp.icpdas.com.tw/pub/cd/fieldbus_cd/hart/converter/i-7547/software/)

6. Version History

Ver.	Author	Date	Description
1.00	Edward	2013/08/27	1. First version
1.01	Edward	2014/04/29	1. Modify the position of Init/Normal in the back of I-7547 . (Refer to section 2.3) [1] Init: Move to down. [2] Normal: Move to up. 2. In FW_v1.03, add the below function. [1] In Web Configuration, add Port1 / Port2 page. [2] In Port1 / Port2 page, add Pair-Connection function. (Refer to section 3.7)
1.02	Edward	2015/10/30	1. Add the FAQ chapter.
1.03	Edward	2016/04/26	1. Add the Q101 in the FAQ chapter.
1.04	Peter	2017/06/22	1. Add the Q05 of FAQ 2. Add the Q06 of FAQ
1.05	Peter	2018/11/27	1. Add the Q07 of FAQ
1.06	Peter	2019/02/14	1. Add the Q08 of FAQ
1.06	Edward	2019/08/28	1. Add the Q102 / Q103 of FAQ