I-7567

USB To HART Converter

User's Manual

Warranty

All products manufactured by ICP DAS are under warranty regarding defective materials for a period of one year from the date of delivery to the original purchaser.

Warning

ICP DAS assumes no liability for damages resulting from the use of this product. ICP DAS reserves the right to change this manual at any time without notice. The information furnished by ICP DAS is believed to be accurate and reliable. However, no responsibility is assumed by ICP DAS for its use, or for any infringements of patents or other rights of third parties resulting from its use.

Copyright

Copyright 2011 by ICP DAS. All rights are reserved.

Trademark

The names used for identification only may be registered trademarks of their respective companies.

Table of Contents

1. Introduction	4
1.1 Features	4
1.2 Specifications	5
2. Hardware	7
2.1 Block Diagram	8
2.2 Pin Assignment of HART Port	9
2.2.1 Pin Function Description	9
2.2.2 HART Connection	9
2.3 Terminator Resistor Settings	12
2.4 Init / Normal Jumper	13
2.4.1 Firmware Update Mode	13
2.4.2 Firmware Operation Mode	14
2.5 LED Indication	15
2.5.1 LED function	15
2.5.2 LED indication Table	16
2.6 Cable Selection	16
3. Driver Installation	17
3.1 Install I-7567 Driver Automatically	17
3.2 Install I-7567 Driver by Manual (Windows x86 Platform)	18
3.3 Install I-7567 Driver by Manual (Windows x64 Platform)	21
3.4 Verify Driver Installation	23
3.5 Uninstall I-7567 Driver	24
3.6 Install I-7567 Driver in Windows10	25
4. HC_Tool Utility	30
4.1 Run Utility	30
4.2 Serial Port and HART Command Settings	30
4.2.1 Serial port settings	30
4.2.2 HART Frame Settings	31
4.3 Search HART devices	32
4.3.1 Search HART devices automatically	32
4.3.2 Search HART devices by manual	33
4.3.3 Search HART devices	34
4.4 Send / Receive HART Frame (SRMsg)	36
4.5 HART Information Log (Data Log)	38
4.6 HART Configuration (HTCfg)	39
4.7 Module Configuration (ModCfg)	41

5. FAQ	44
Q01 : How to use I-7567 to communicate with HART devices ?.....	44
Q02 : Does I-7567 support the API Library for HART ?	44
Q03 : I-7567 driver installation for Windows10 ?	44
Q04 : Set HART device address by using HART converter ?	44
6. History Version.....	47

1. Introduction

The I-7567 is a USB to HART converter specially designed as the master device of HART protocol. It allows users to access the HART slave via virtual COM-port of PC and the baud rate must be set 1200 bps.

When connecting I-7567 to PC, PC will load the relevant device driver automatically (hot plug & play). Therefore, users can make data collection and processing of HART network easier and quicker by applying I-7567. In addition, by using the I-7567 utility, users can configure module and test HART communication easily.

The following is the application structure of the USB/HART modules.



1.1 Features

- Support HART Short/Long frame
- Support HART Burst mode.

-
- Support point-to-point or multi-drop HART mode.
 - Support connecting up to 15 HART slave devices.
 - Allow two HART masters.
 - Provide utility tool for module configuration and HART communication.
 - No external power supply (powered by USB)
 - Support firmware update via USB
 - Provide PWR / Tx / Rx indication LED
 - 4KV ESD Protection
 - Selectable 250Ω load resistor (1/4W)

1.2 Specifications

[USB Spec.]

- Input port : USB (USB Type B)
- Compatibility : USB 1.1 and 2.0 standard
- Driver Supported : Windows 2000 / XP / Vista / 7 (32/64 bit)
- Virtual COM Parameter : **1200** bps, **O**(odd parity), **8**(data bit), **1**(stop bit)

[HART Spec.]

- Channel : 1
- Connector : 2-pin screwed terminal-block
- Network : Point to Point or Multi-drop
- Baud Rate : **1200** bps
- Frame : Short or Long
- Operates as a HART Master and supports all HART commands
- Support up to 15 HART slave devices
- Isolation Voltage : 3KVdc on the HART side

[Module Spec.]

- Dimensions : 108mm x 72mm x 35mm (H x W x D)
- Operating temperature : -25 to 75°C (-13 to 167°F);
- Storage temperature : -30 to 75°C (-22 to 167°F);
- Humidity : 5 to 95%, non-condensing;
- Indication LEDs :
PWR LED : Module power status

Tx LED : Data received from USB
Rx LED : Data received from HART port

[Utility Tool]

- Provide module configuration and HART communication easily and quickly.
- Provide HART devices search automatically.
- Provide diagnostic Information of HART device.
- Provide data logging for HART communication.

[Application]

- Current Measuring;
- Petrochemical Industry Application;
- Environment Monitoring;
- Tunnel Monitoring;
- Monitor system;
- Building Monitoring etc.;

2. Hardware



Figure 2-1: Hardware externals of I-7567

2.1 Block Diagram

Figure 2-2 is a block diagram illustrating the functions on the I-7567 module. It provides the 3000Vrms Isolation in the HART interface site.

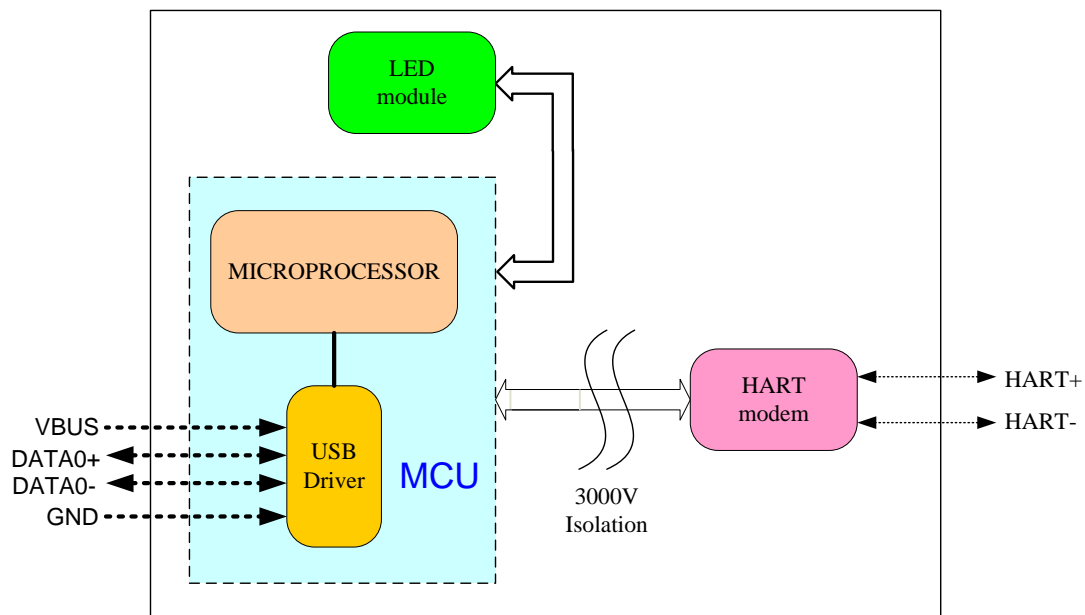

Figure 2-2: Block diagram of I-7567

2.2 Pin Assignment of HART Port

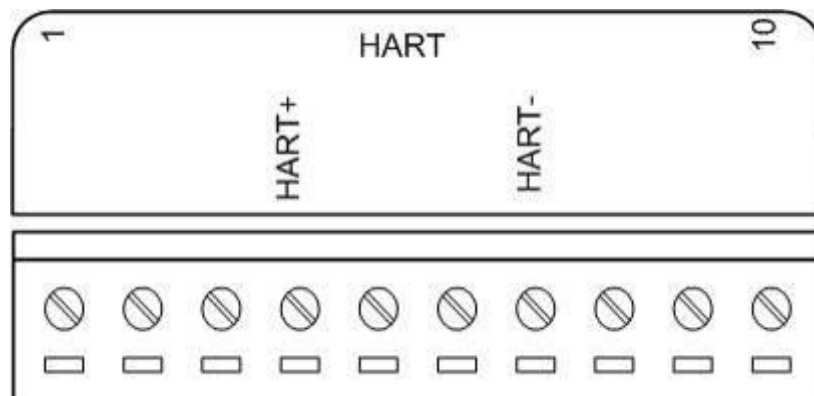

Figure 2-3: Pin Assignment on I-7567

2.2.1 Pin Function Description

Pin No.	Pin Name	Pin Function Description
1	-	N/A
2	-	N/A
3	-	N/A
4	HART+	HART+
5	-	N/A
6	-	N/A
7	HART-	HART-
8	-	N/A
9	-	N/A
10	-	N/A

2.2.2 HART Connection

The HART connection can be divided to the following two types :

- (1) "Loop Power Source" Mode.
- (2) "External Power Source" Mode.

Loop Power Source (1) – internal resistance

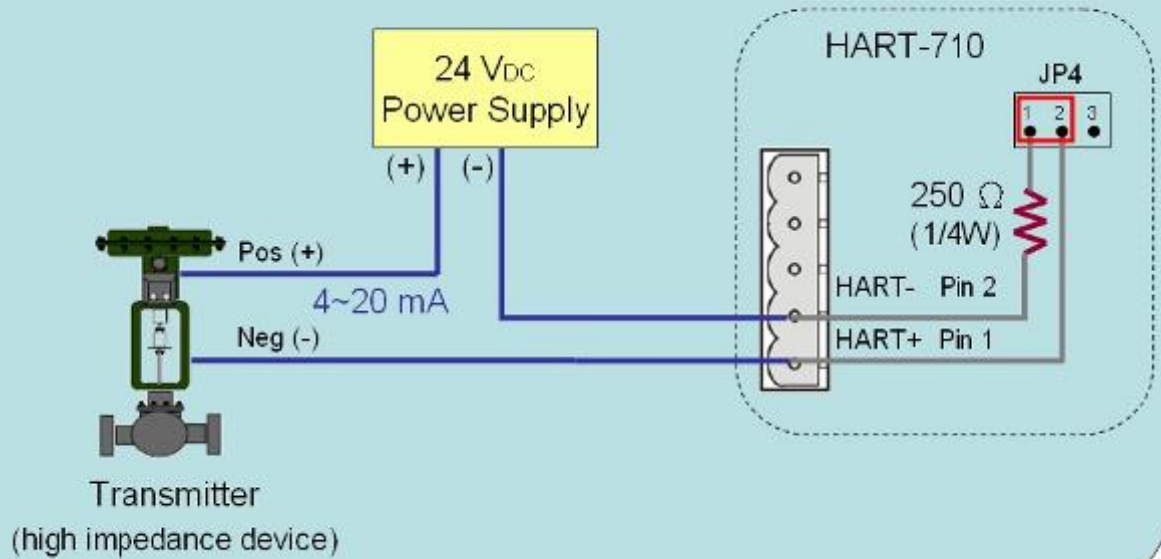

Ex1 : Loop Power Source (Internal Resistance)

Loop Power Source (2) – external resistance

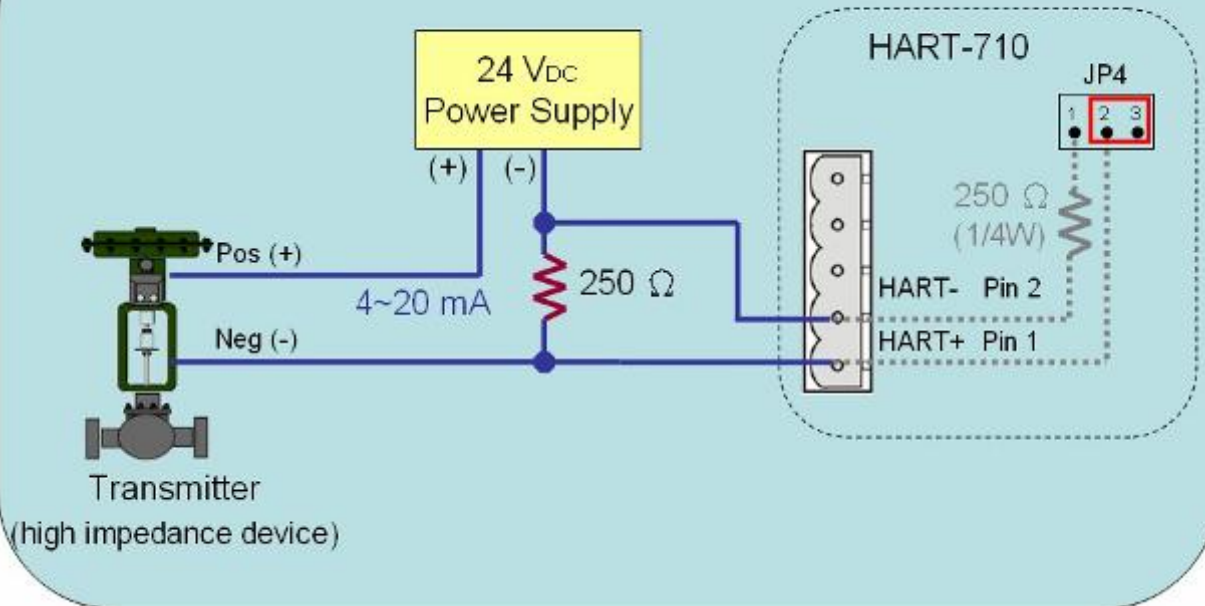

Ex2 : Loop Power Source (External Resistance)

Loop Power Source (3) – external resistance

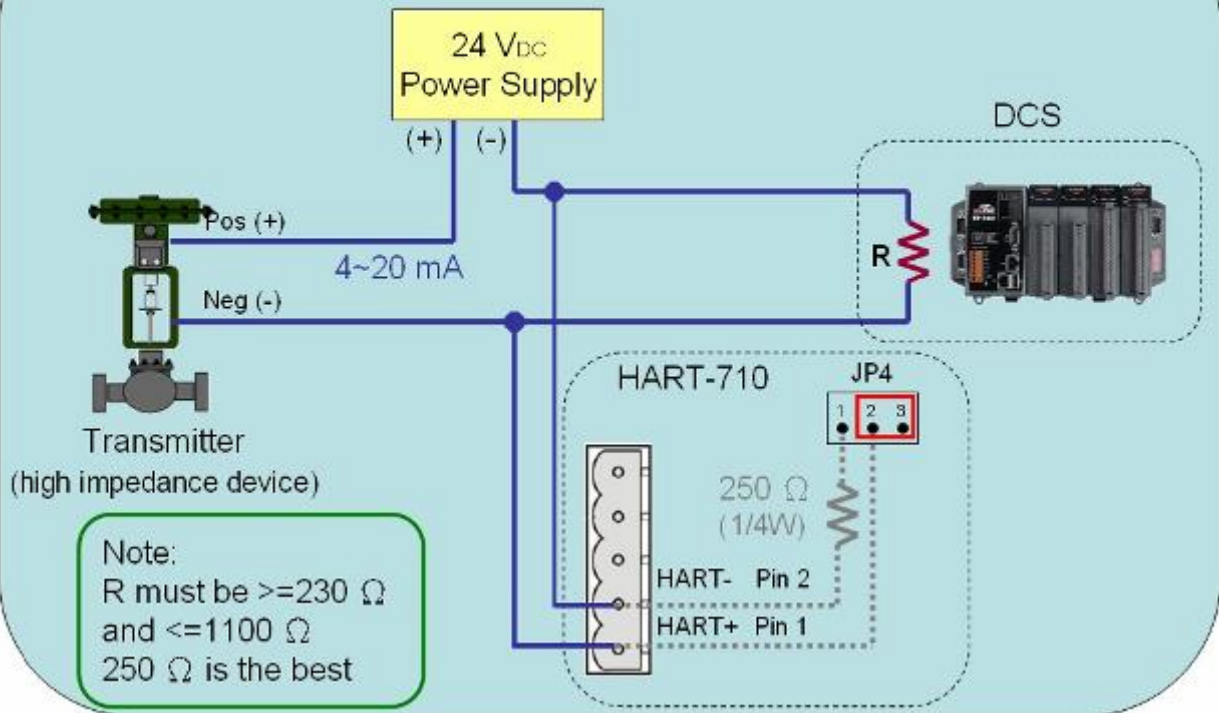

Ex3 : Loop Power Source (External Resistance)

External Power Source – external resistance

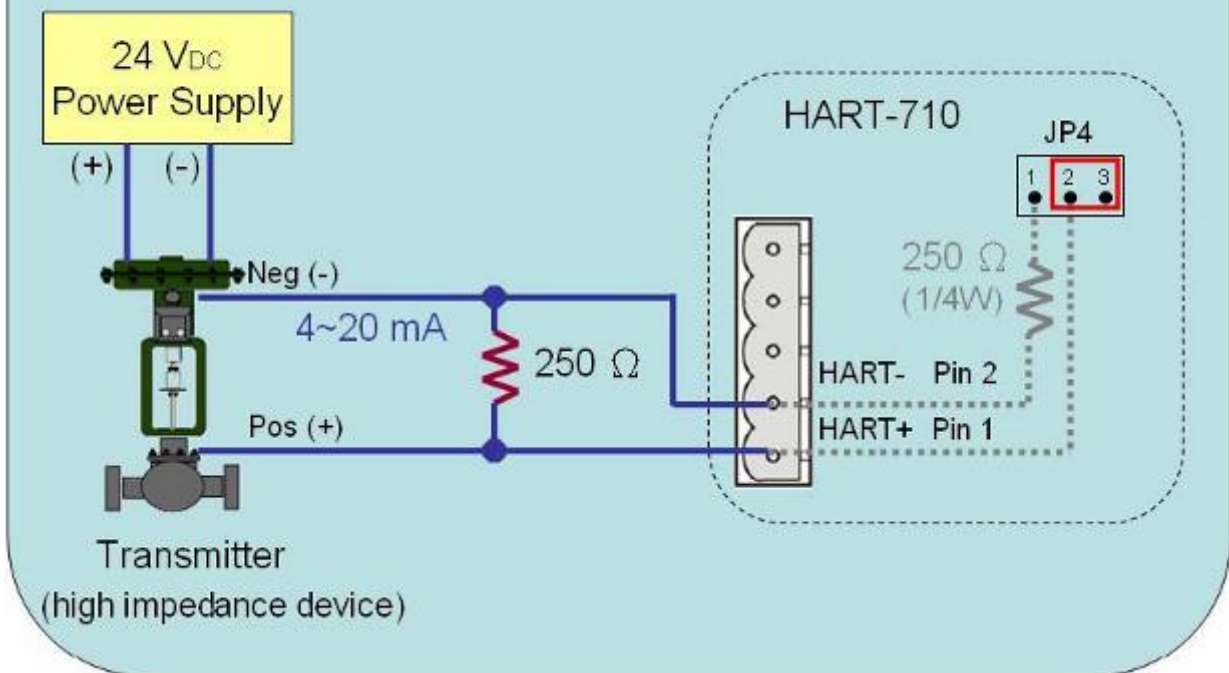

Ex4 : External Power Source (Internal Resistance)

2.3 Terminator Resistor Settings

The DIP switch is used to provide HART network with 250 Ω (1/4 W) resistor. When it is set to “On”, the resistor will connect to HART network. Otherwise, it will disconnect the resistor from HART network. The default position of the DIP switch is in “On”.

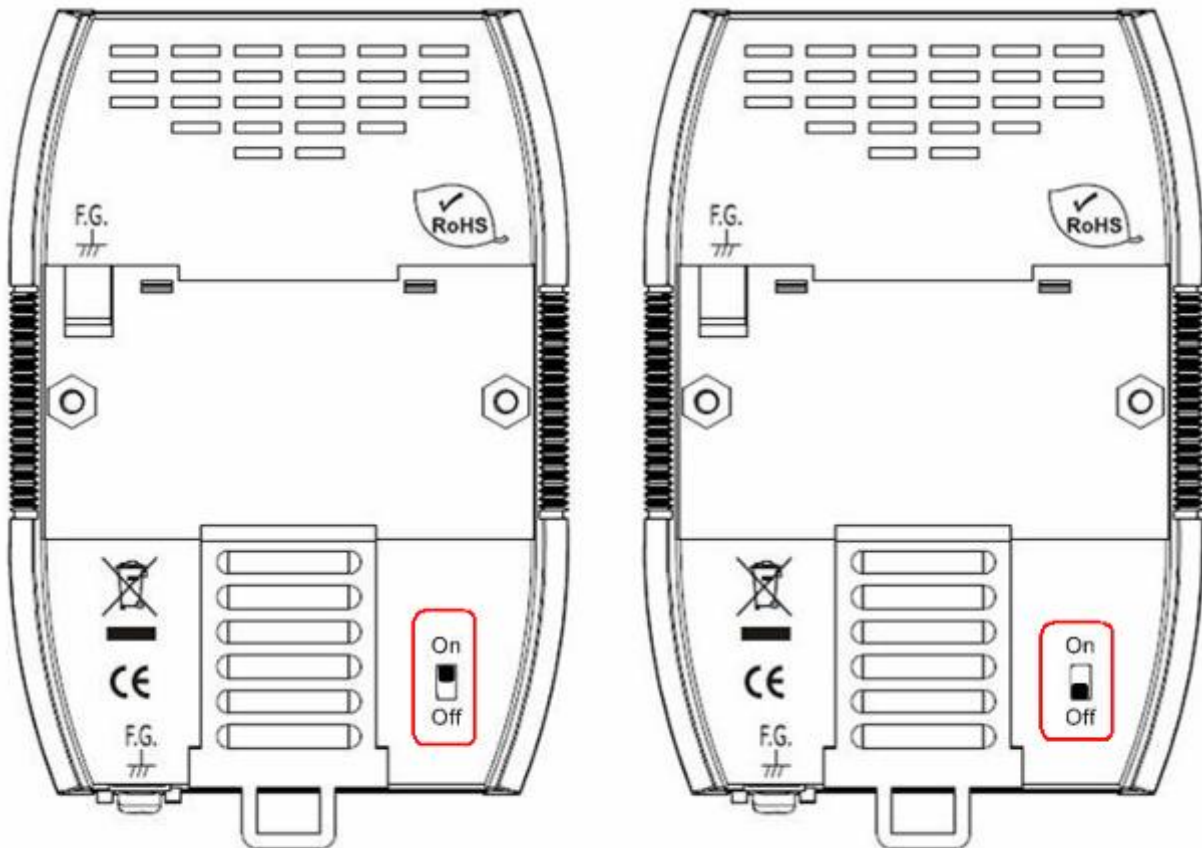

Figure 2-5: Enable Internal Resistor. Figure 2-6: Disable Internal Resistor.

2.4 Init / Normal Jumper

Open the shell of I-7567 and there is a jumper (JP1) on the PCB of I-7567 is used for firmware operation or firmware updating function of I-7567 module.

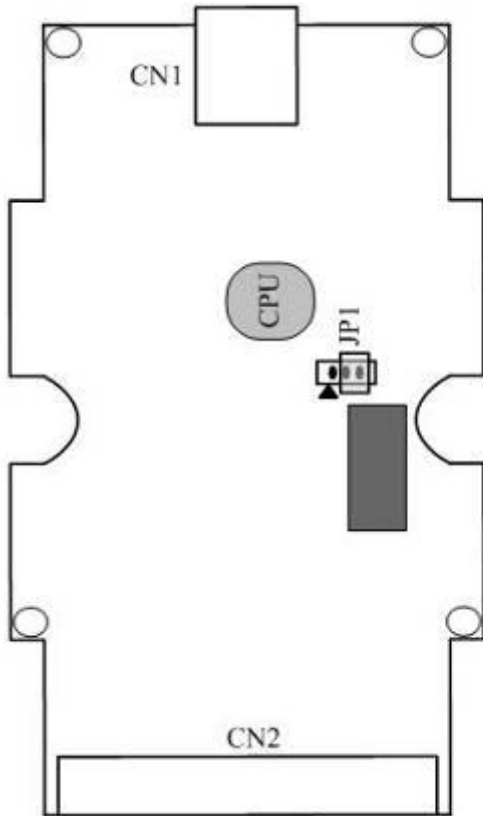

Figure 2-7: Firmware Operation

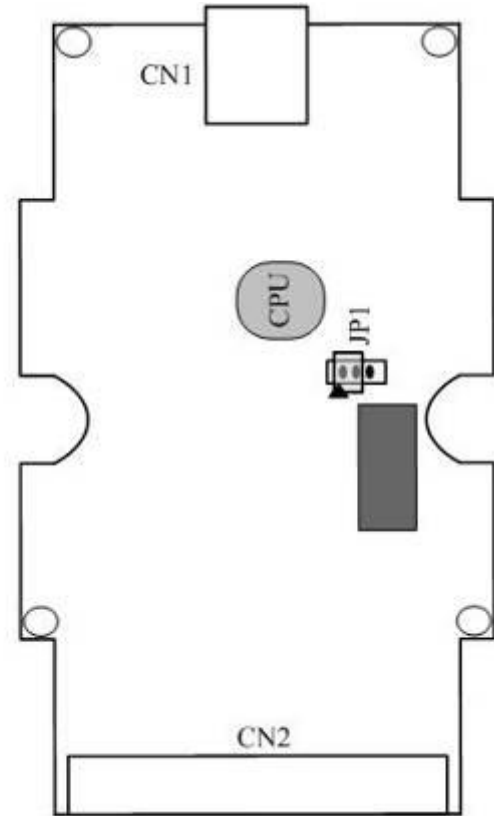

Figure 2-8: Firmware Updating

2.4.1 Firmware Update Mode

Please follow the below steps to complete the firmware update process of I-7567.

- (1) Set the jumper (JP1) to the firmware updating position like Figure 2-8 and reboot I-7567. Then I-7567 will work in the “Firmware Update Mode”. In this mode, users can update the firmware of I-7567 module via USB and the I-7567 will become a “USB Mass Storage” device like Figure 2-9.

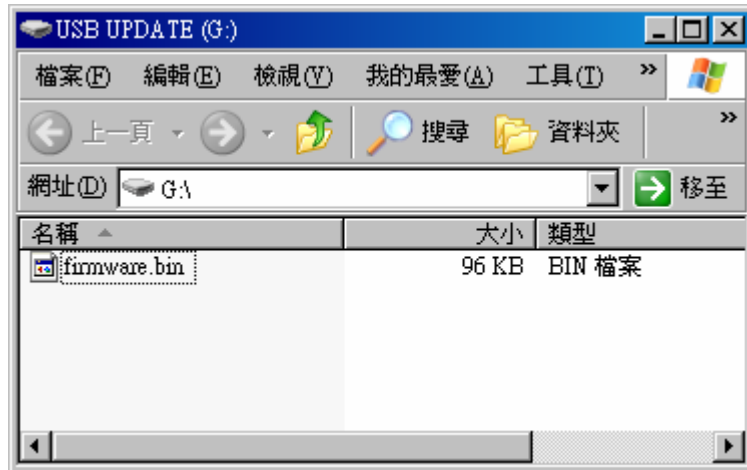
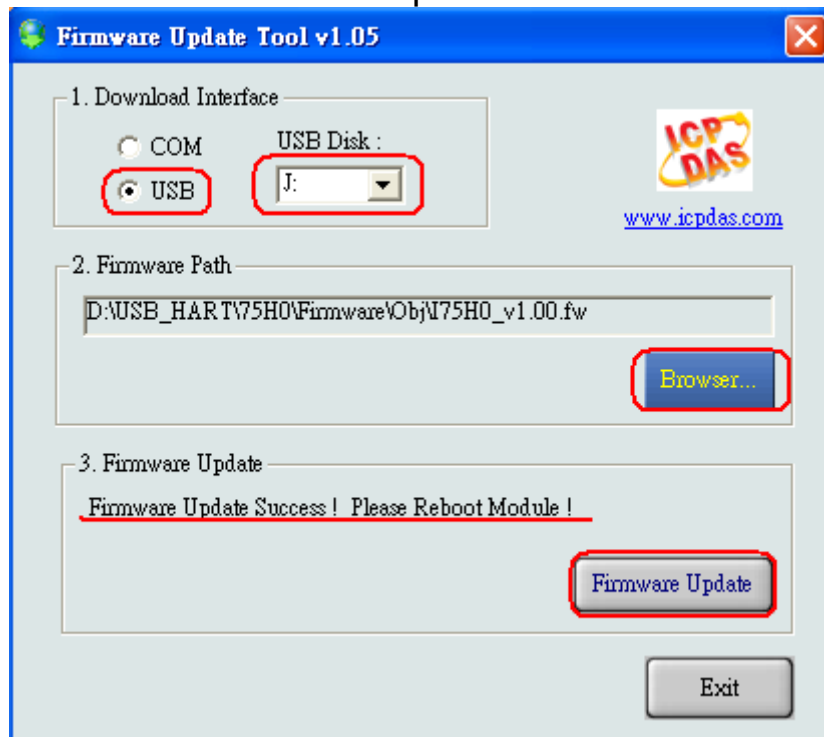

Figure 2-9: USB Mass Storage Device (G:\)

- (2) Execute the “**FW_Update_Tool**” utility. (Download from http://ftp.icpdas.com/pub/cd/fieldbus_cd/hart/converter/i-7567/software/)
- [1] Choose “**USB**” interface and “**USB Disk**” (like : J:).
 - [2] Click “**Browser**” button to choose FW file (like : **I7567_v1.00.fw**).
 - [3] Click “**Firmware Update**” button to start FW update process.
- The result will show in “Firmware Update” field.



2.4.2 Firmware Operation Mode

In operation mode, users need to set the jumper (JP1) to the firmware operation position like Figure 2-7 and reboot I-7567. In this mode, users

can send / receive HART frame via USB port of PC.

2.5 LED Indication

There are three LEDs provided to indicate what situation the I-7567 is in. The Figure 2-10 is the illustration of these three LEDs.



Figure 2-10: LED position of I-7567

2.5.1 LED function

(1) PWR LED :

When power on I-7567, if I-7567 is in the firmware operation mode, then the PWR LED will be on permanently. If I-7567 is in the firmware update mode, then all the LED will be off.

(2) Tx LED :

When I-7567 received the data from USB, then the Tx LED will flash until the data transmission completed.

(3) Rx LED :

When I-7567 received the HART frame from HART device, then the Rx LED will flash until the data transmission completed.

2.5.2 LED indication Table

LED Name	Power off	No Driver	FW Update	FW Operation	USB Port Data Received	HART Port Data Received
PWR LED	off	flash	off	on	on	on
Tx LED	off	flash	off	off	flash	off
Rx LED	off	flash	off	off	off	flash

2.6 Cable Selection

The HART bus is a balanced (differential) 2-wire interface running over a Shielded Twisted Pair (STP), Un-shielded Twisted Pair (UTP), or Ribbon cable. How to decide a cable type, cable length, and terminator in the HART bus network, please refer to the following table.

No. Network Devices	Cable Capacitance – pf/ft (pf/m)			
	20 pf/ft (65 pf/m)	30 pf/ft (95 pf/m)	50 pf/ft (160 pf/m)	70 pf/ft (225 pf/m)
1	9,000 ft (2,769 m)	6,500 ft (2,000 m)	4,200 ft (1,292 m)	3,200 ft (985 m)
5	8,000 ft (2,462 m)	5,900 ft (1,815 m)	3,700 ft (1,138 m)	2,900 ft (892 m)
10	7,000 ft (2,154 m)	5,200 ft (1,600 m)	3,300 ft (1,015 m)	2,500 ft (769 m)
15	6,000 ft (1,846 m)	4,600 ft (1,415 m)	2,900 ft (892 m)	2,300 ft (708 m)

Allowable cable lengths for 1.0mm (#18 AWG) shield twisted pair

Note: The AWG means a standard method used to measure wire. The numbering system works backwards from what people would think, the thicker (heavier) the wire, the lower the number.

3. Driver Installation

This section will show how to install the I-7567 USB/HART converter device driver under Windows 2000/XP and Win7. Users can download the I-7567 device driver from ICP DAS web site:

ftp://ftp.icpdas.com/pub/cd/fieldbus_cd/hart/converter/i-7567/usb_driver/

3.1 Install I-7567 Driver Automatically

[Step - 1]

Plug-in the I-7567 to PC first and Windows will detect the new device and shows the “Found New Hardware Wizard” screen prompting you to install the driver for the detected USB Device. Please click “Cancel” button to cancel driver installation by manual like Figure 3-1.



Figure 3-1: New Hardware Wizard (1)

[Step - 2]

Execute “**icpusbconverter_drvinst_v1.2.exe**” file to install driver automatically and then click “Continue Anyway” button like Figure 3-2. After driver installation process finished, it will show the screen like Figure 3-3.



Figure 3-2: New Hardware Wizard (2)



Figure 3-3: Install I-7567 Driver Finished

3.2 Install I-7567 Driver by Manual (Windows x86 Platform)

[Step - 1]

Please execute “`icpusbconverter_drvinst_v1.4.exe`” file first to install necessary driver files of I-7567 to system.

[Step - 2]

Plug in the I-7567 to PC and Windows will detect the new device and shows the “Found New Hardware Wizard” screen prompting you to install the driver for the detected USB Device. Please select “No, not this time” option and click “Next” button like Figure 3-4.



Figure 3-4: New Hardware Wizard (1)

[Step - 3]

Please select “install from a list or specific location (Advanced)” option and click “Next” button like Figure 3-5.



Figure 3-5: New Hardware Wizard (2)

[Step - 4]

Please select “Search for the best driver in these locations” option and check “include this location in the search:” checkbox and click “Browser” button to assign the I-7567 driver location - C:\WINDOWS\inf and then click “Next” button like Figure 3-6.

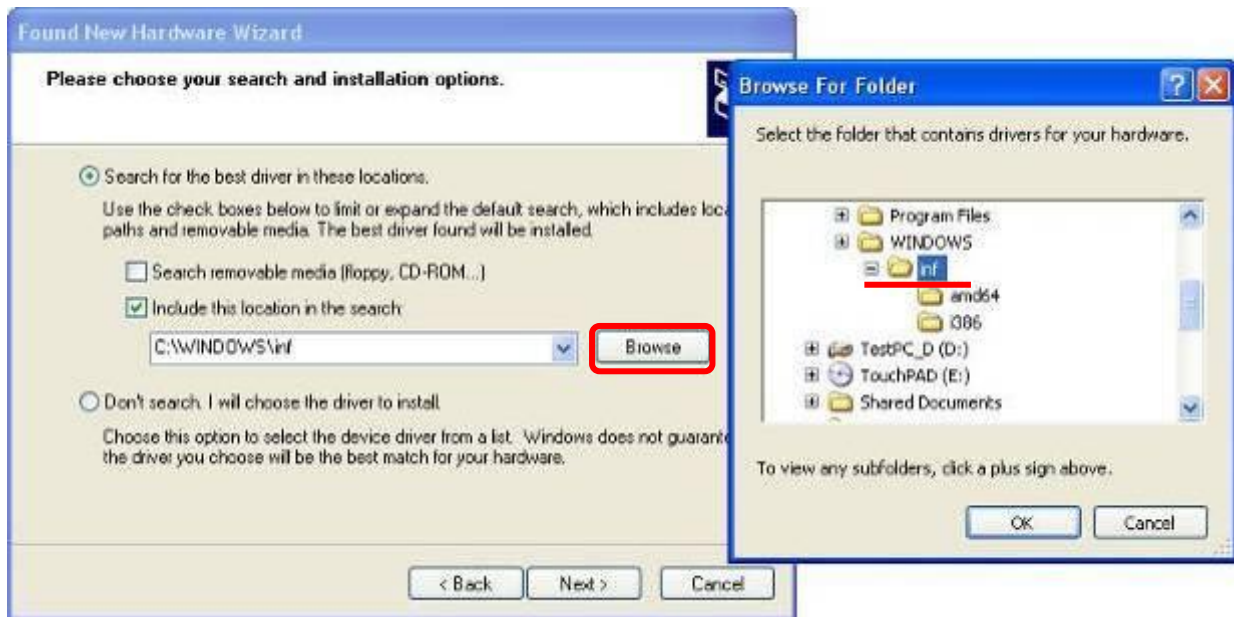

Figure 3-6: New Hardware Wizard (3)

[Step - 5]

Please click “Continue Anyway” button like Figure 3-7 .



Figure 3-7: New Hardware Wizard (4)

[Step - 6]

Please click “Finish” button to complete I-7567 device driver installation like Figure 3-8.



Figure 3-8: New Hardware Wizard (5)

3.3 Install I-7567 Driver by Manual (Windows x64 Platform)

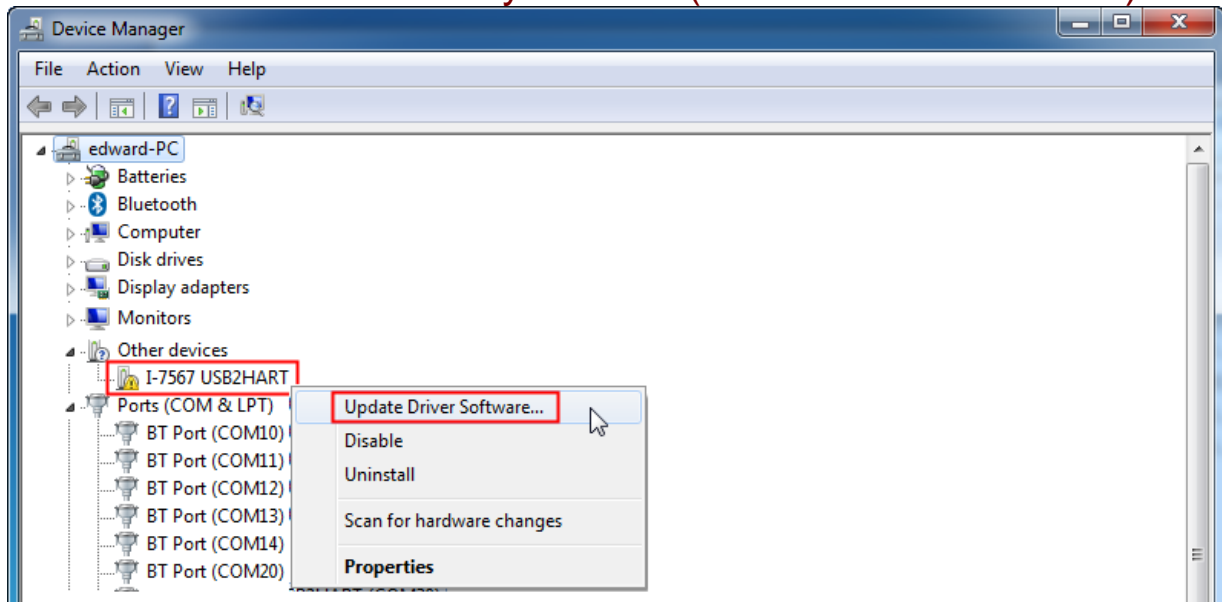

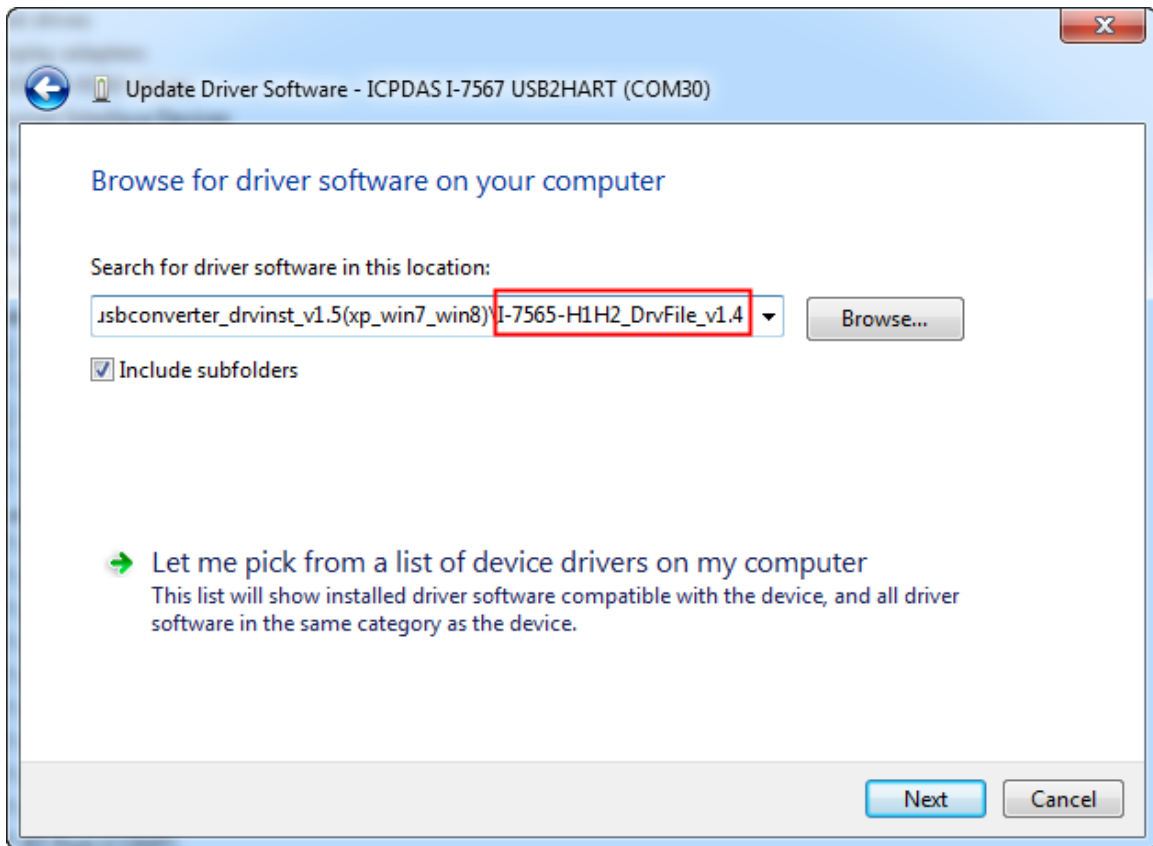

[Assign the I-7567 driver to the "I-7565-H1H2_DrvFile_v1.4" folder]

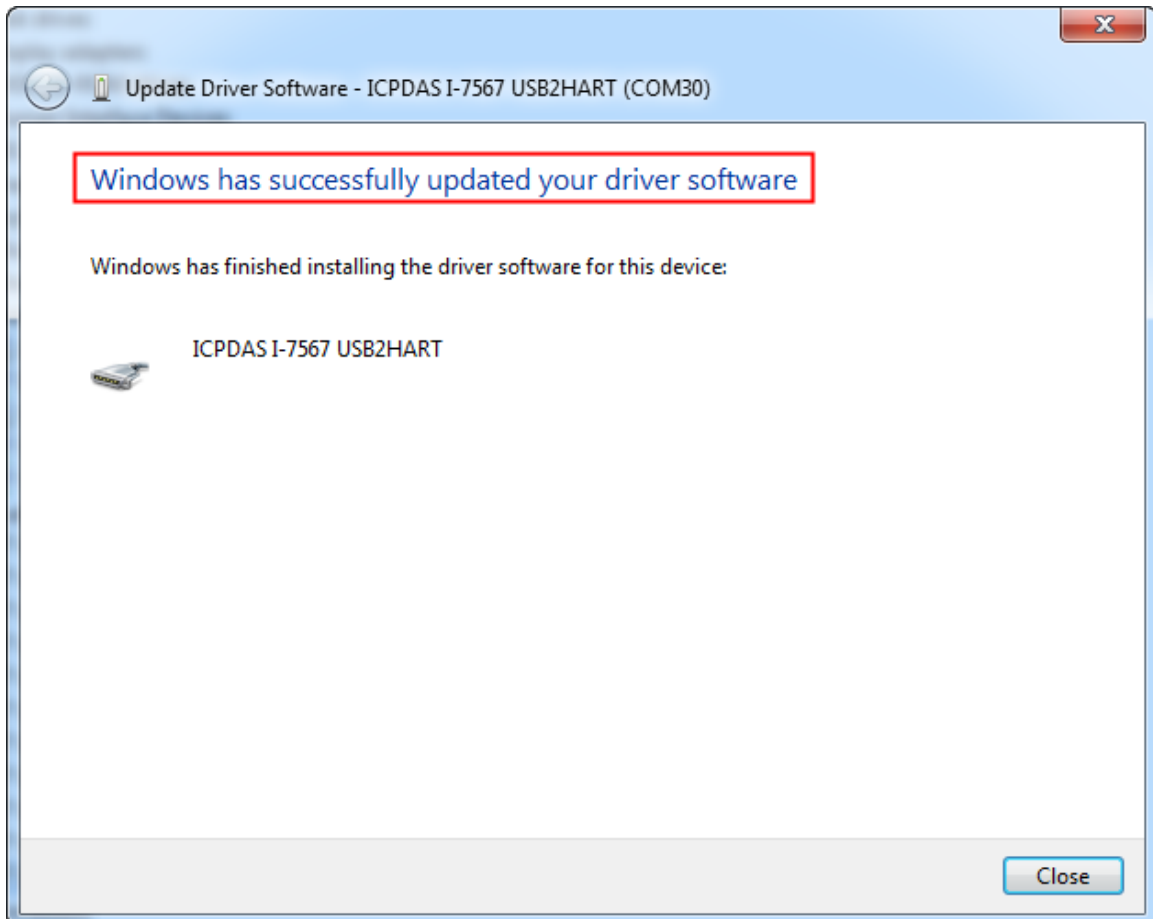

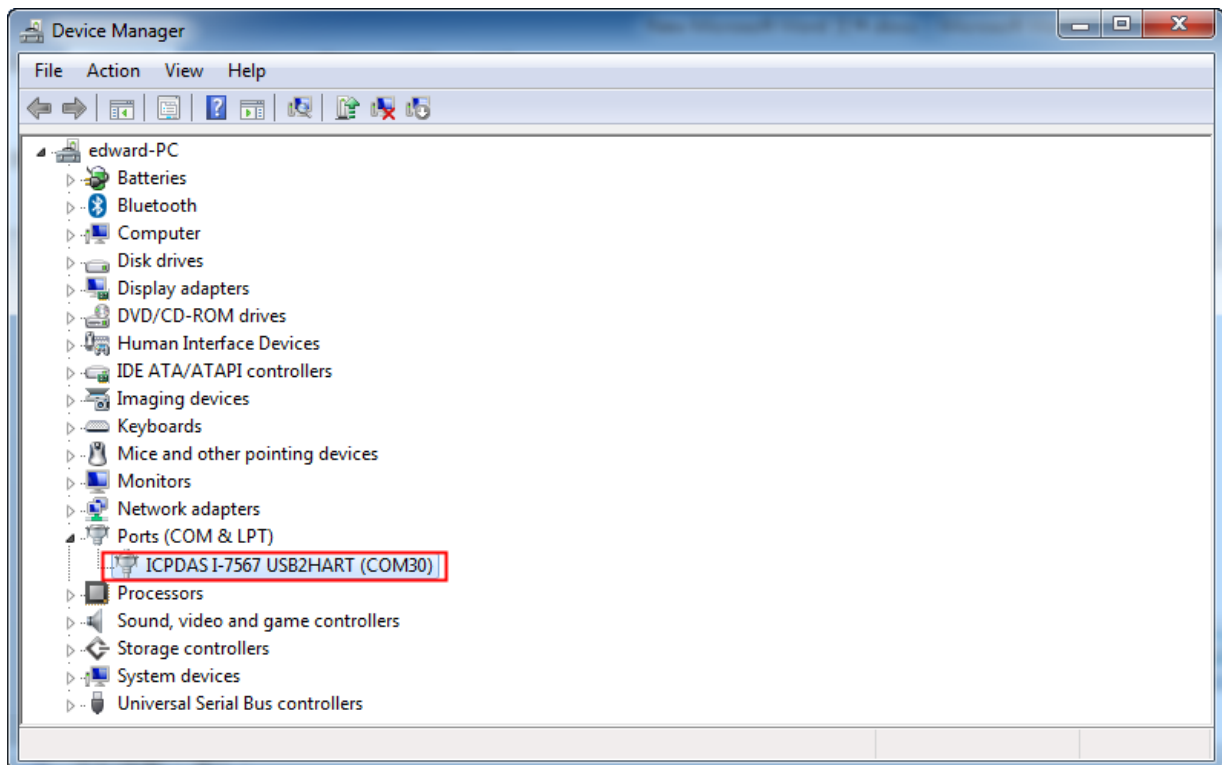

3.4 Verify Driver Installation

This section will show how to verify whether the driver of I-7567 was properly installed. If the driver is installed successfully, then there will be a “Virtual COM Port” assigned by Windows. Please follow the below steps to check it.

Click “**Start**” → “**Settings**” → “**Control Panel**” and then double click on the “**System**” icon. Once the “**System Properties**” screen displayed, click on “**Hardware**” tab and then click on the “**Device Manager**” button. Double-click on **Ports (COM & LPT)** item. If the device driver was correctly installed, users can find the “ICPDAS I-7567 USB2HART” device listing and the “Virtual COM Port” number that Windows has assigned to the device is **COM3** like Figure 3-9.

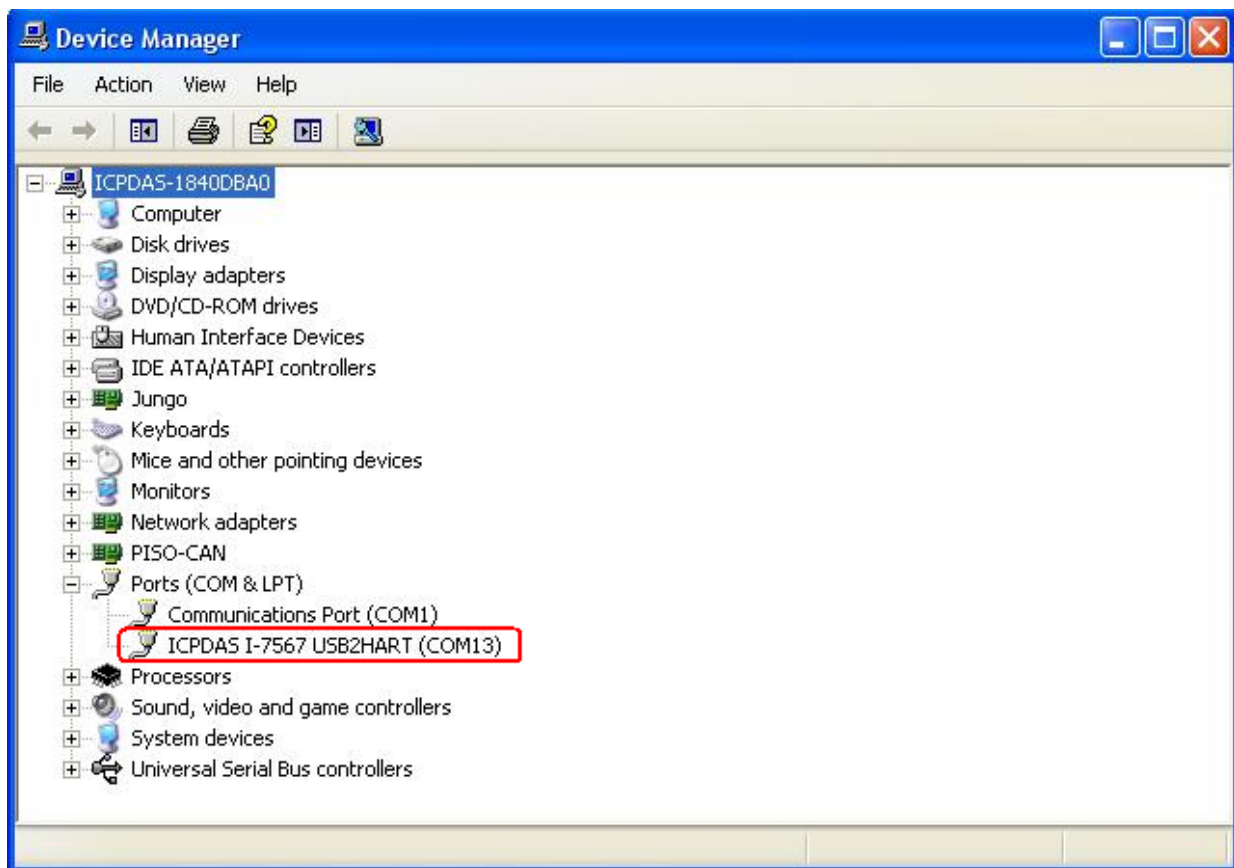

Figure 3-9: Virtual COM Port Number

3.5 Uninstall I-7567 Driver

Please follow the below steps to uninstall I-7567 device driver.

[Step - 1]

Click **“Start”** → **“Settings”** → **“Control Panel”** and then double click on the **“System”** icon. Once the **“System Properties”** screen displayed, click on **“Hardware”** tab and then click on the **“Device Manager”** button. Double-click on **Ports (COM & LPT)** item. Please find the **“ICPDAS I-7567 USB2HART”** device listing and click the right button on the mouse and choose **“Uninstall”** item like Figure 3-10.

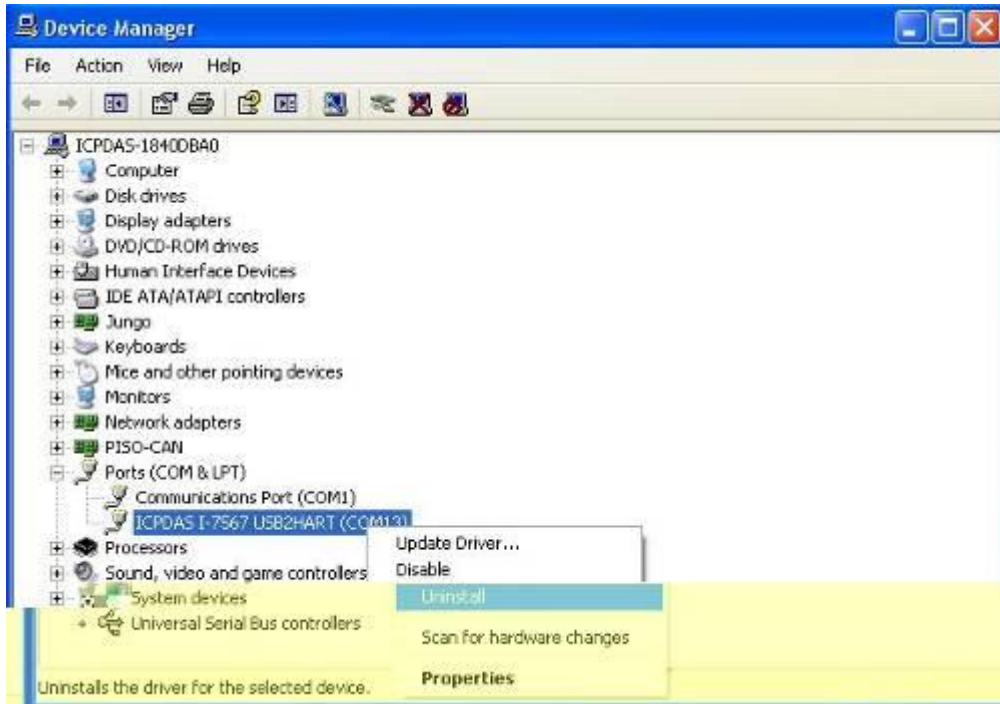

Figure 3-10: Uninstall I-7567 Driver (1)

[Step - 2]

Click “**OK**” button to complete I-7567 device driver un-installation like Figure 3-11. After that, the “ICPDAS I-7567 USB2HART” device listing will disappear on **Ports (COM & LPT)** item.

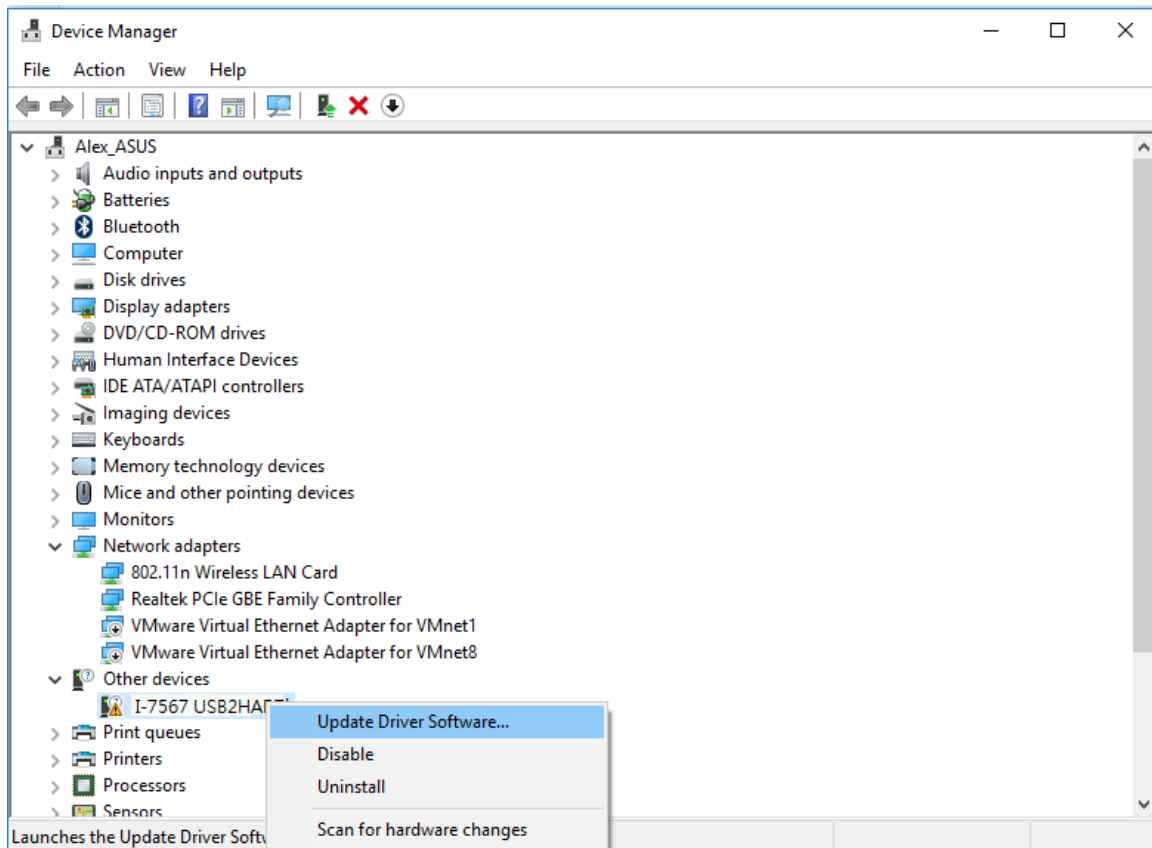

Figure 3-11: Uninstall I-7567 Driver (2)

3.6 Install I-7567 Driver in Windows10

Please follow the below steps.

1. Click the right button of mouse on the **【I-7567 USB2HART】** option and choose **【Update Driver Software ...】** .



2. Click the **【Browse my computer for driver software】** option.

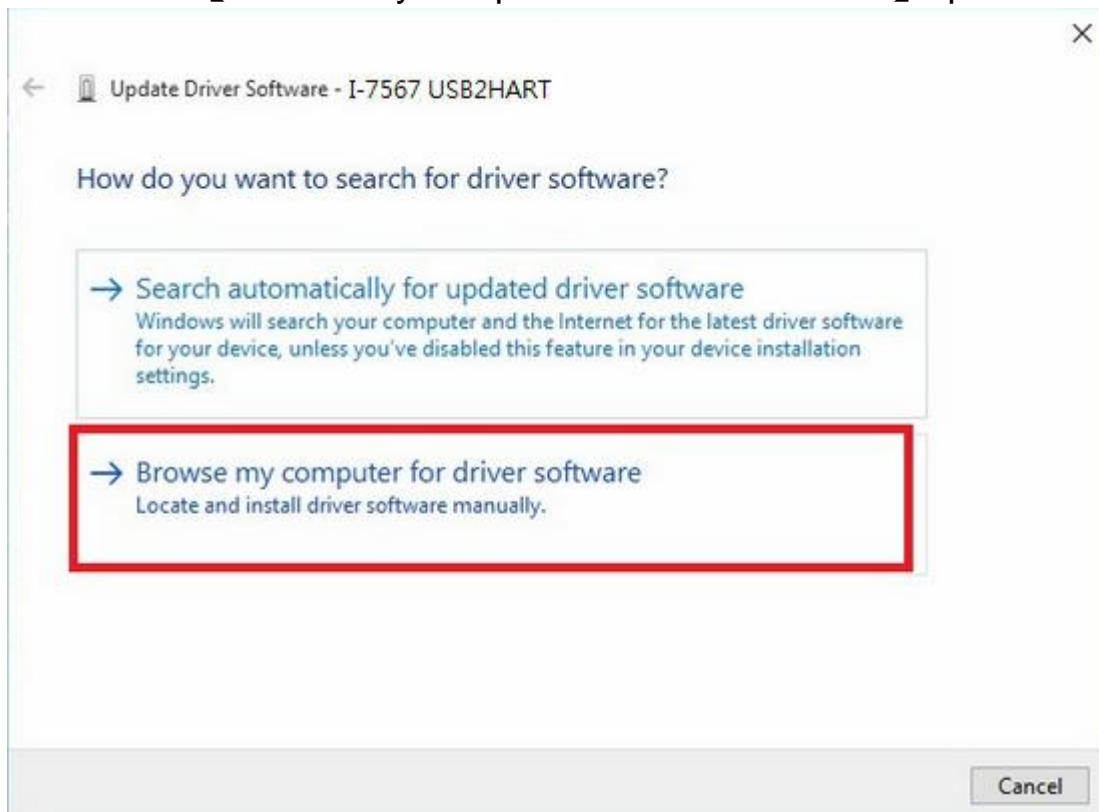

3. Click the **【Let me pick from a list of device drivers on my computer】** option.

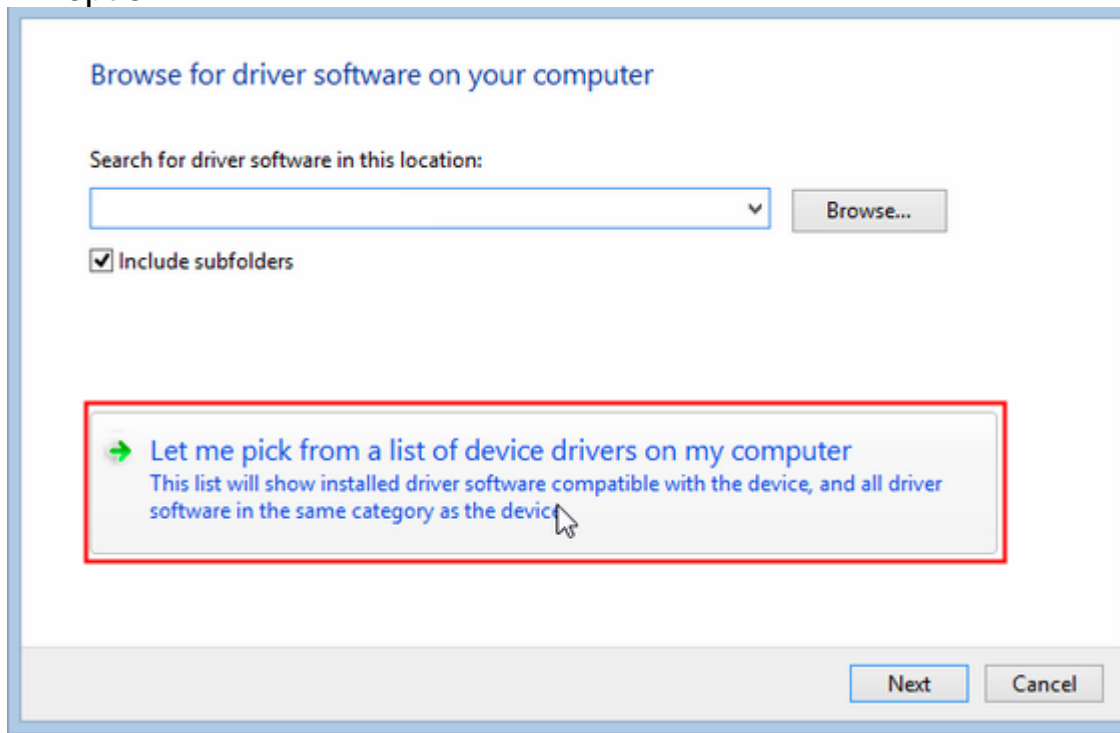

4. Directly click the **【Next】** button ◦

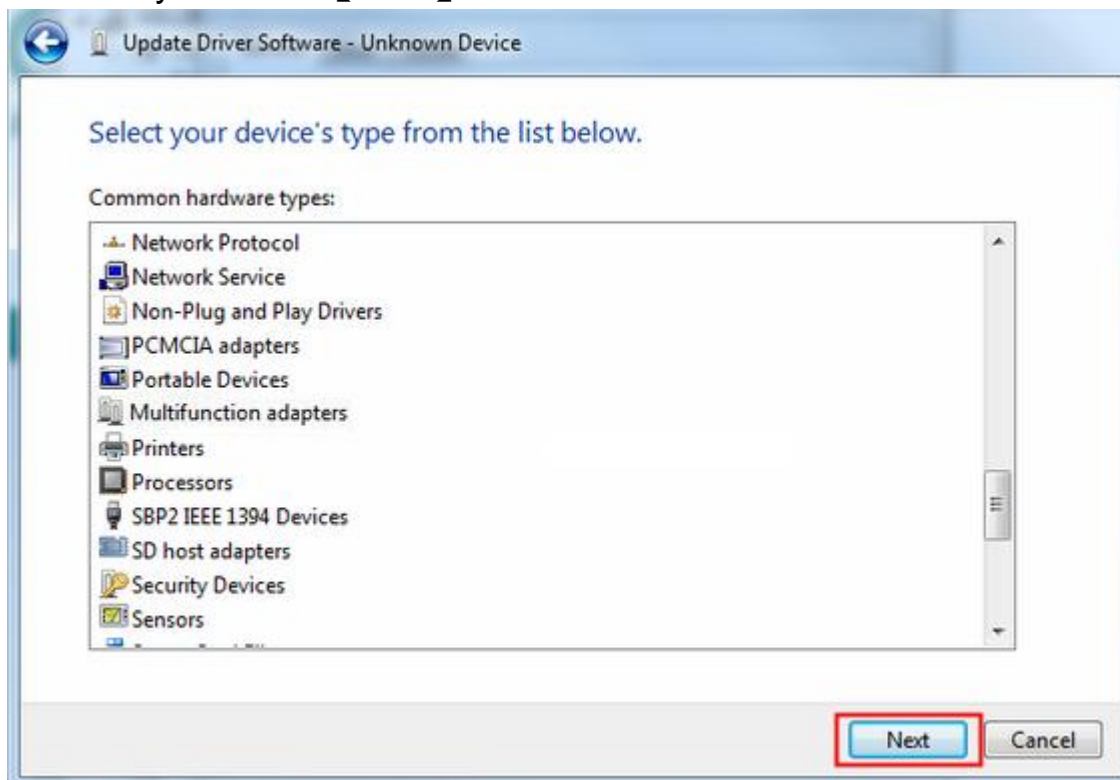

5. Click the **【USB Serial Device】** option and click the **【Next】** button.

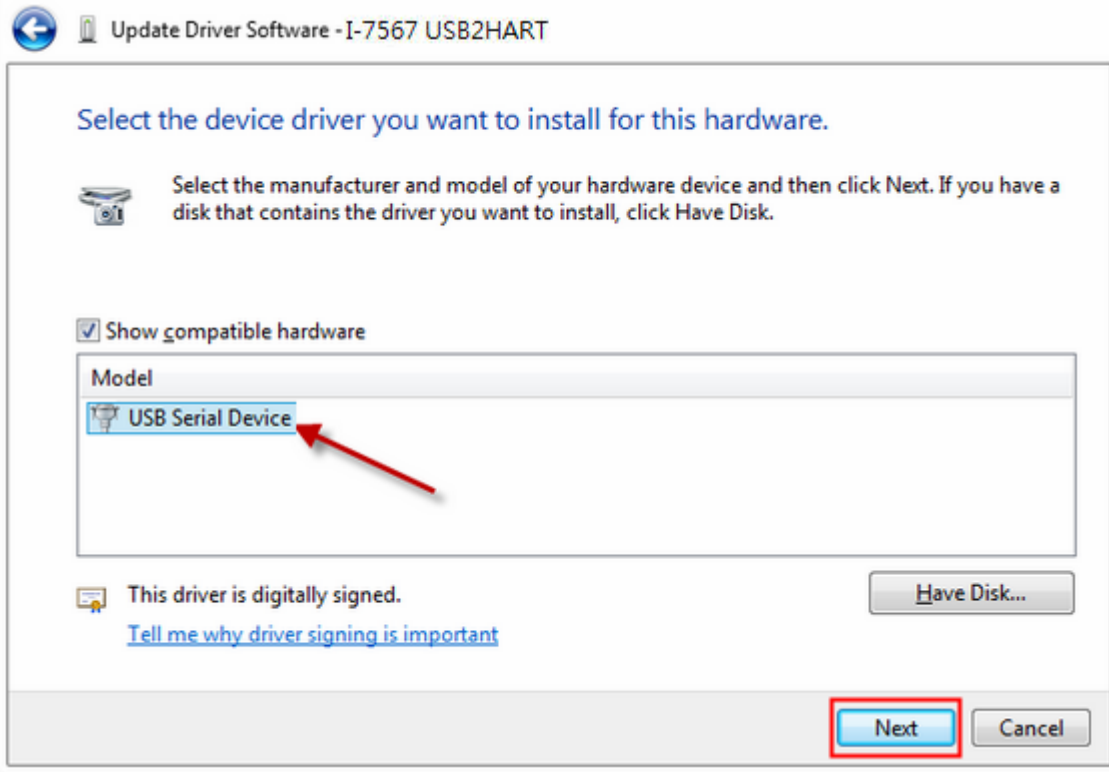

6. Show the **【Windows has successfully updated your driver software】** message and it means that I-7567 driver installation is finished.



7. In the **【Device Manager】**, The **【USB Serial Device (COMx)】** will show up. (In Win10, I-7567 device message can't be shown.)

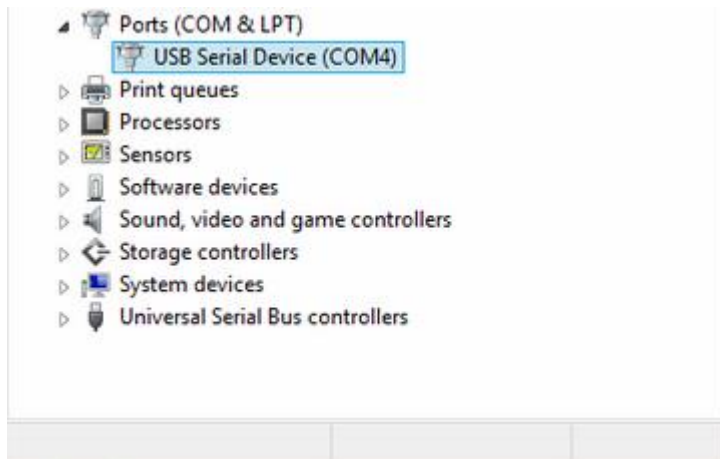

4. HC_Tool Utility

HC_Tool utility is provided to configure ICP DAS all HART converter modules (like I-7567 / I-7570) or transmit / receive HART frame for HART communication easily and quickly. HC_Tool utility can be downloaded from the ICP DAS web site :

http://ftp.icpdas.com/pub/cd/fieldbus_cd/hart/converter/i-7567/software/.

4.1 Run Utility

Run the “**HC_Tool**”, like Figure 4-1. If users can’t run “HC_Tool”, please install .NET Framework 3.5 first.

(<http://www.microsoft.com/downloads/details.aspx?familyid=333325FDAE52-4E35-B531-508D977D32A6&displaylang=en>).

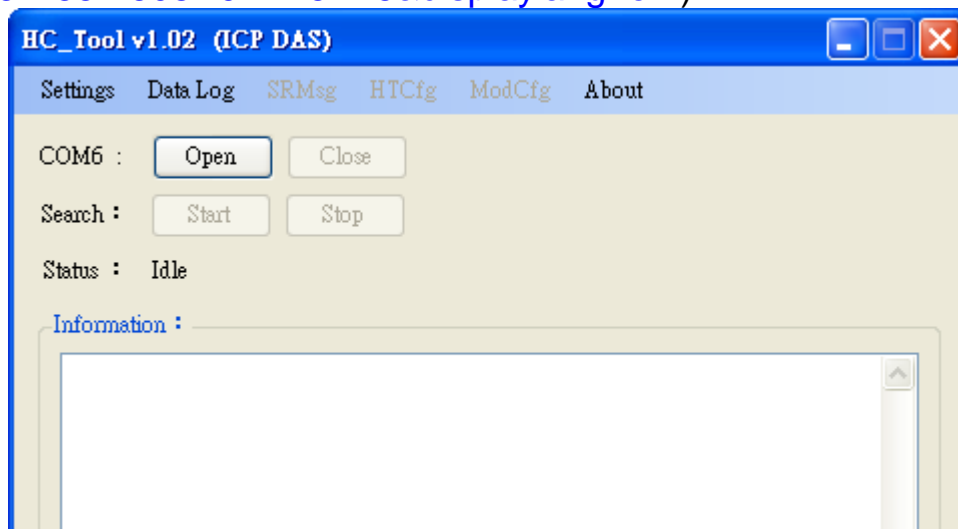

Figure 4-1: HC_Tool Utility

4.2 Serial Port and HART Command Settings

Please click “**Settings**” item to open setting window of serial port and HART parameters like Figure 4-2.

4.2.1 Serial port settings

- (1) Please select serial port no. of PC like Figure 4-2.

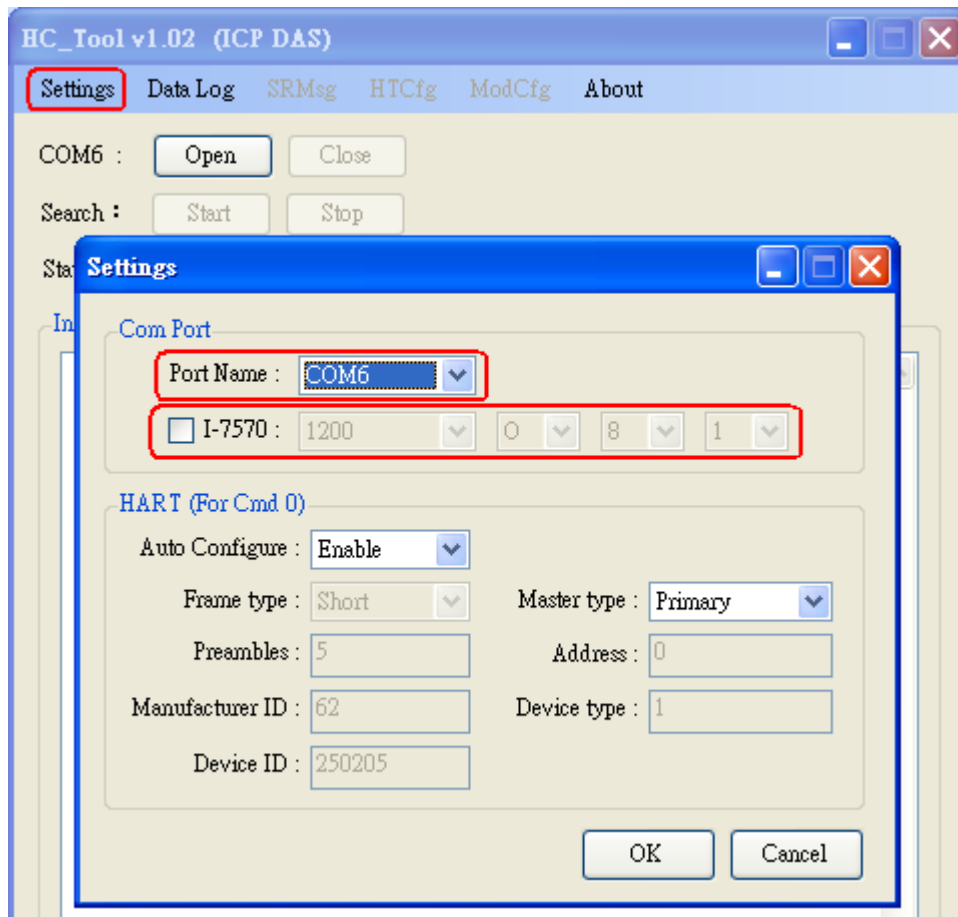

Figure 4-2: Set Serial Port No.

(2) If using I-7570 module, please check “I-7570” item and select the communication parameters of PC serial port. Note, the settings of the communication parameters must be the same with those in I-7570.

4.2.2 HART Frame Settings

The following is the description of HART command fields.

Auto Configure : (1) Enable : search HART devices automatically.

(2) Disable : search HART devices according to manual parameters.

Frame type : Select HART frame format (Short/Long).

Master type : Select Primary master or Secondary master.

Preambles : Select 5~20 bytes (0xFF) number.

Address : Select HART Polling Address (0~15).

Manufacturer ID: Manufacturer Identification Code

Device type : Manufacturer Device Type Code

Device ID : Manufacturer Device Identification Code.

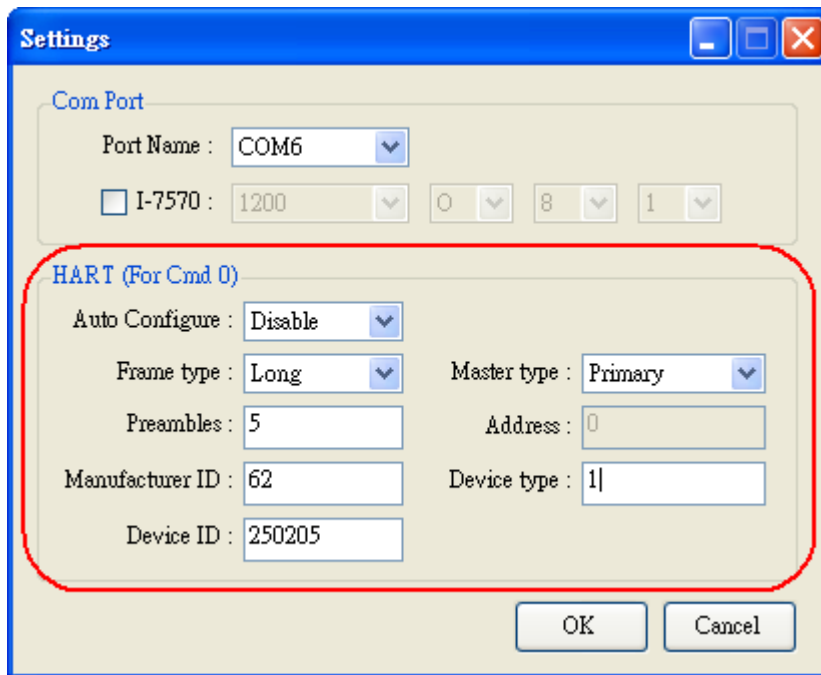

Figure 4-3: Set HART Frame Format

4.3 Search HART devices

4.3.1 Search HART devices automatically

Set the option of “Auto Configure” field to be “Enable” and the option of “Master type” field to be “Secondary” like Figure 4-4. Then HC_Tool utility will automatically search all HART devices by using HART short frame with “Secondary Master” identity.

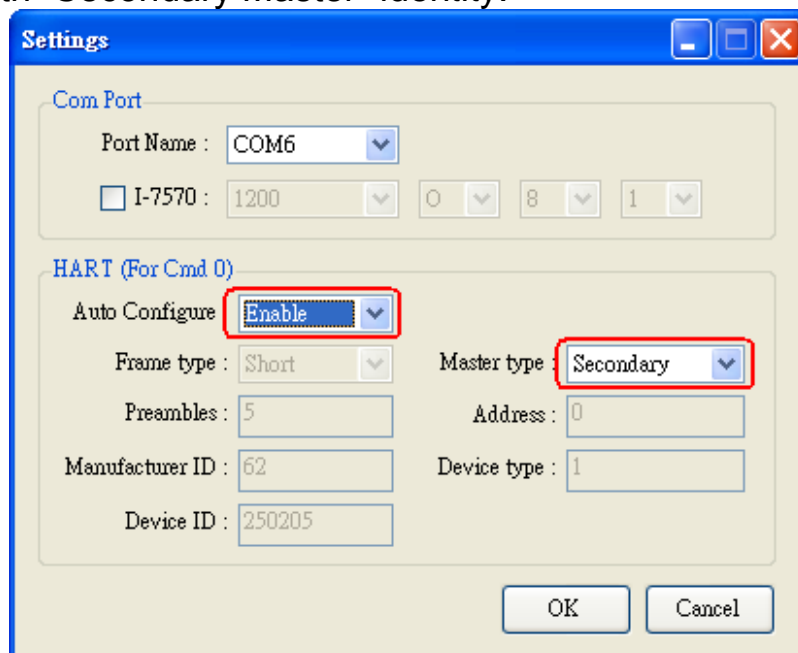

Figure 4-4: Auto Configure - Enable

4.3.2 Search HART devices by manual

Set the option of “Auto Configure” field to be “Disable” and then users can set the HART frame by manual to search HART devices.

- (1) If the option of “Frame type” field is “Short”, then “Master type”, “Preambles”, “Address” fields need to be configured like Figure 4-5.

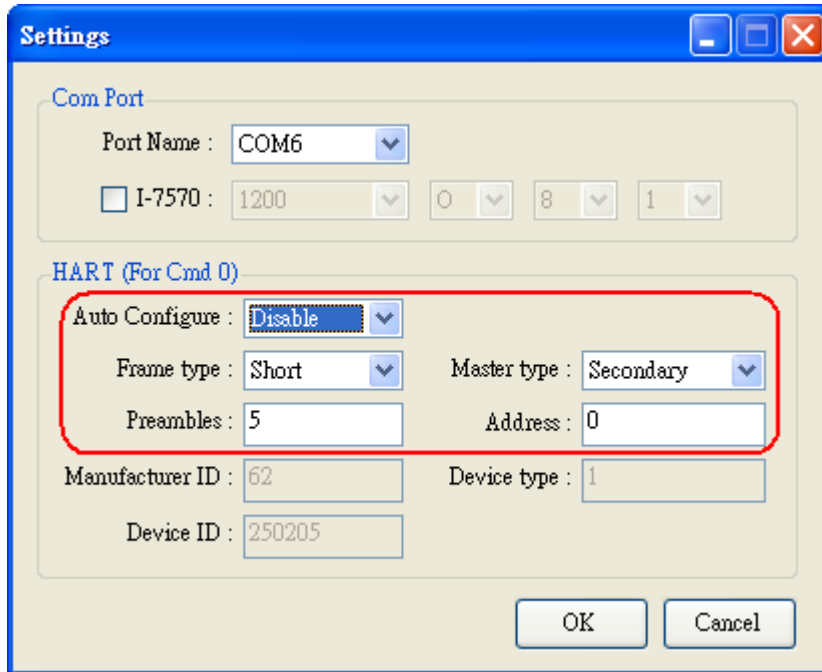

Figure 4-5: Short frame settings

- (2) If the option of “Frame type” field is “Long”, then “Master type”, “Preambles”, “Manufacturer ID”, “Device type”, “Device ID” fields need to be configured like Figure 4-6.

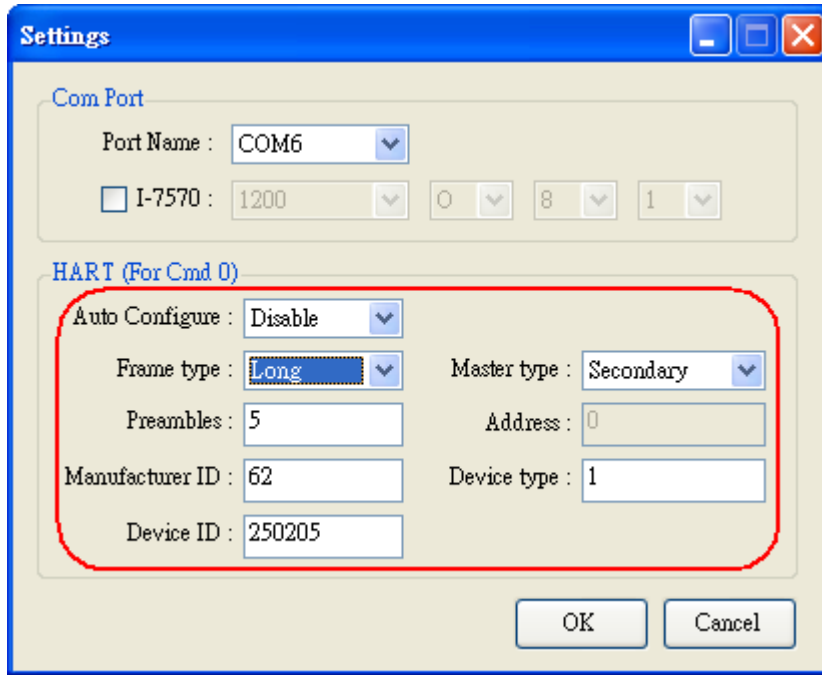

Figure 4-6: Long frame settings

If the setting of serial port and HART frame format is finished, please click the “OK” button. Then users can test the HART communication.

4.3.3 Search HART devices

- (1) Click “**Open**” button to open the com port of PC like Figure 4-7. If com port open failed, please check the com port setting.

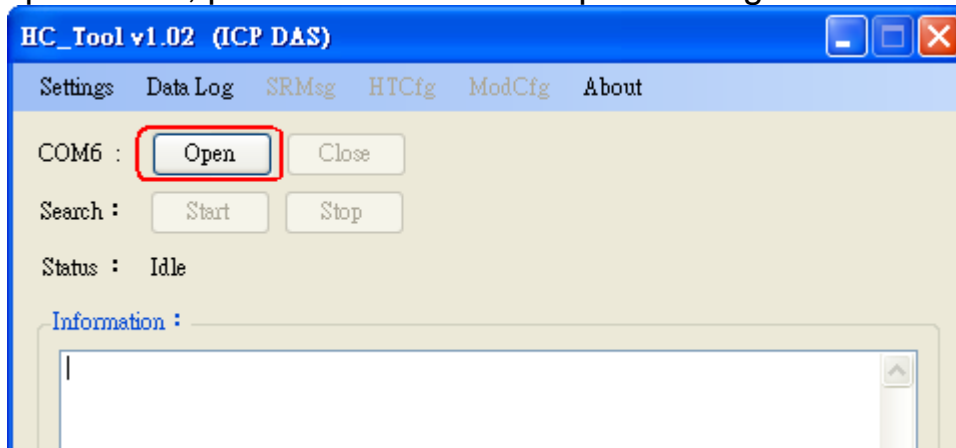

Figure 4-7: Click “Open” button

- (2) Click “**Start**” button to search all HART devices and the result will be shown in the “Information” field like Figure 4-8.

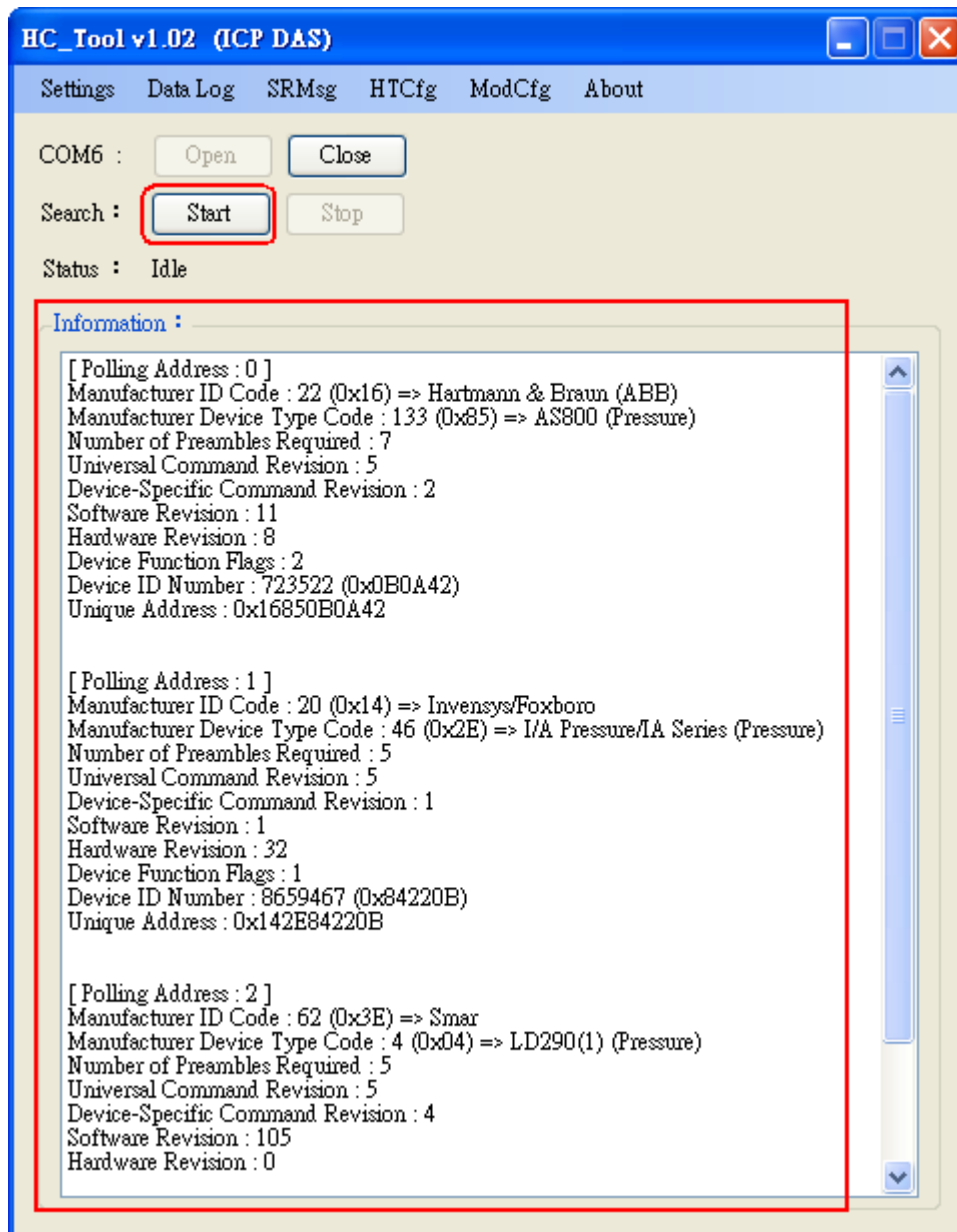

Figure 4-8: HART device Information

If the error message - “Search Device Failed !!” shows like Figure 4-9, please check HART network status and HART command format.

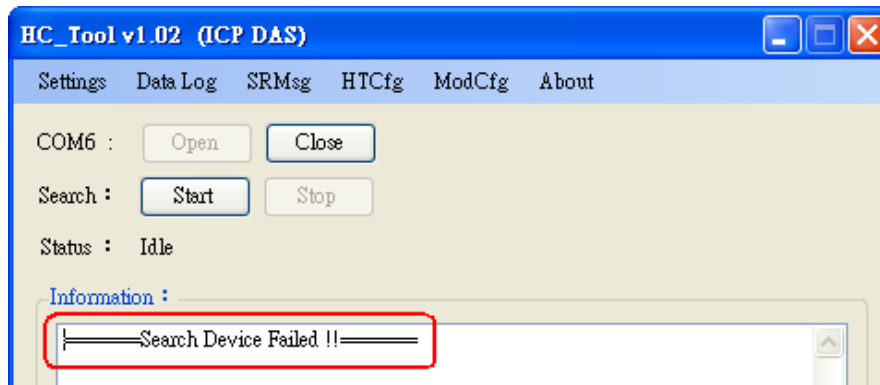

Figure 4-9: Search Device Failed

4.4 Send / Receive HART Frame (SRMsg)

- (1) Click “**SRMsg**” item and it will open the HART command function window for HART communication like Figure 4-10.

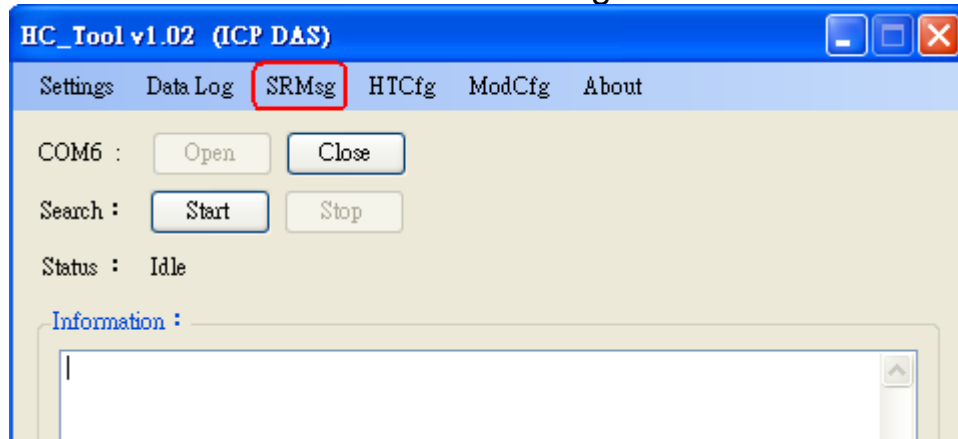

Figure 4-10: SRMsg Function

- (2) Please type the HART command in the "Send Data" field and click "Send" button to send out the HART command like Figure 4-11.

[1] “**With Parity Check**” item :

When check the item, it will add the “check byte” automatically while sending the HART frame.

[2] “**Auto Scroll**” item :

When check the item, it will scroll the HART message field automatically to show the latest HART message information.

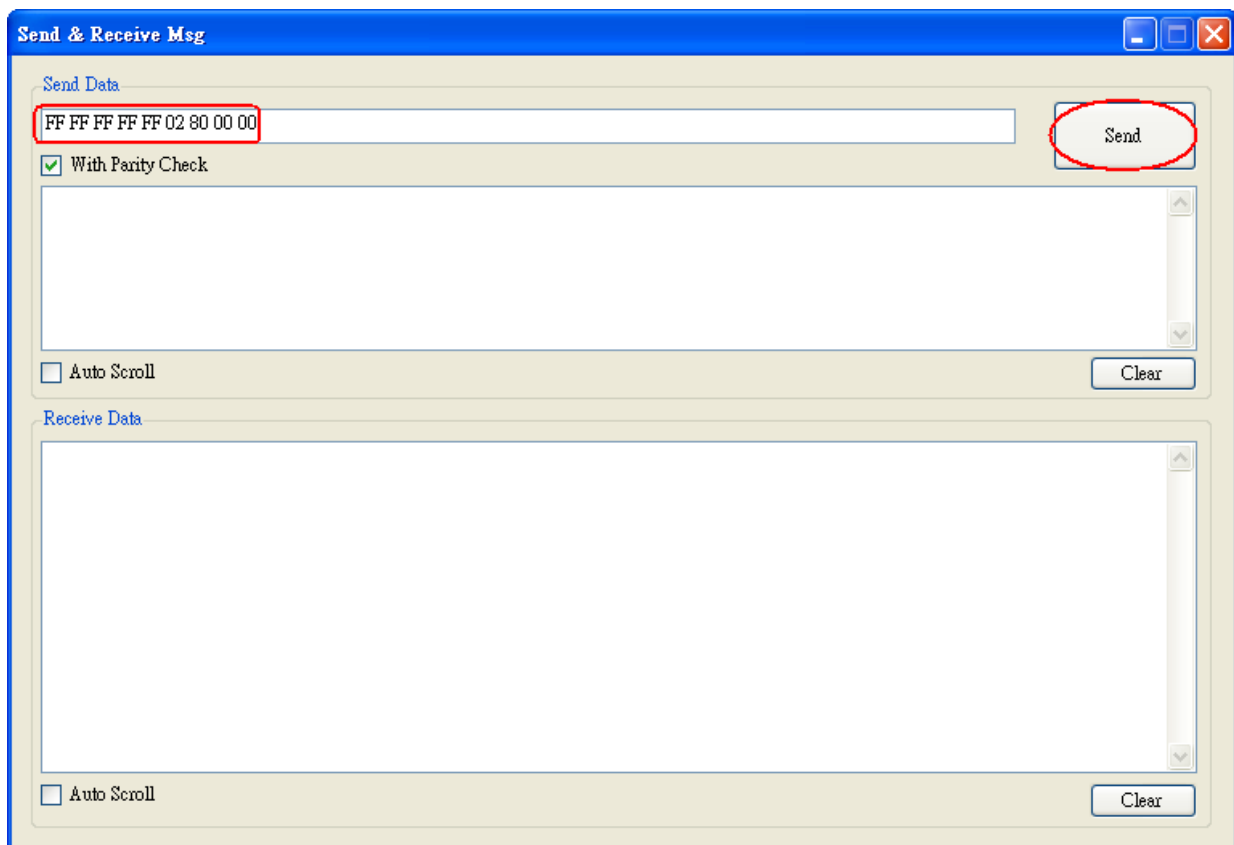

Figure 4-11: Send HART Command

- (3) When HART device responses the HART information, it will show in the "Receive Data" field like Figure 4-12. If error happened in HART communication, it will not show any message in the "Receive Data" field. Please check the HART command in the "Send Data" field if it is correct.

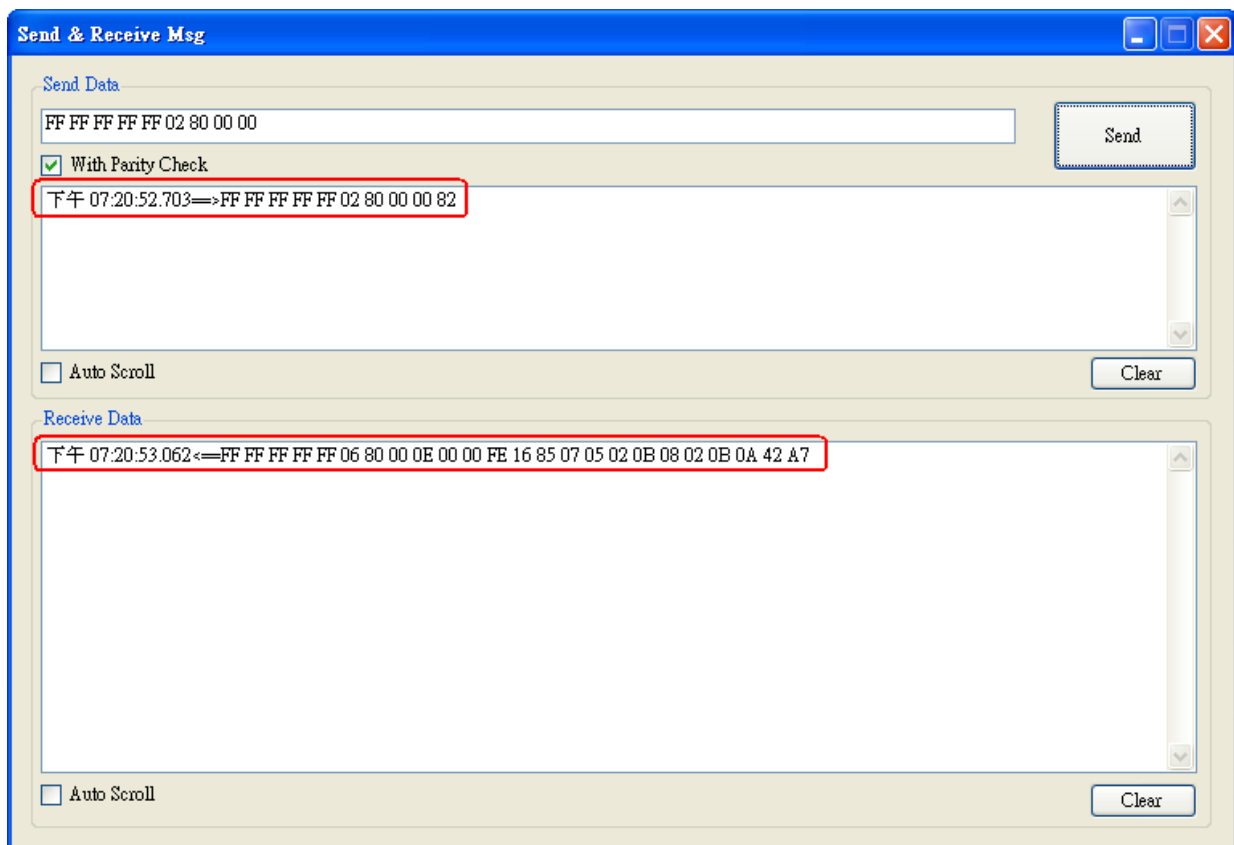

Figure 4-12: Receive HART Command

4.5 HART Information Log (Data Log)

When using "SRMsg" or "Start" function for HART communication, all the HART command information will be logged in the "Data Log" function. Users can click "**Data Log**" item and all the HART communication information will be shown in "Log" field like Figure 4-13.

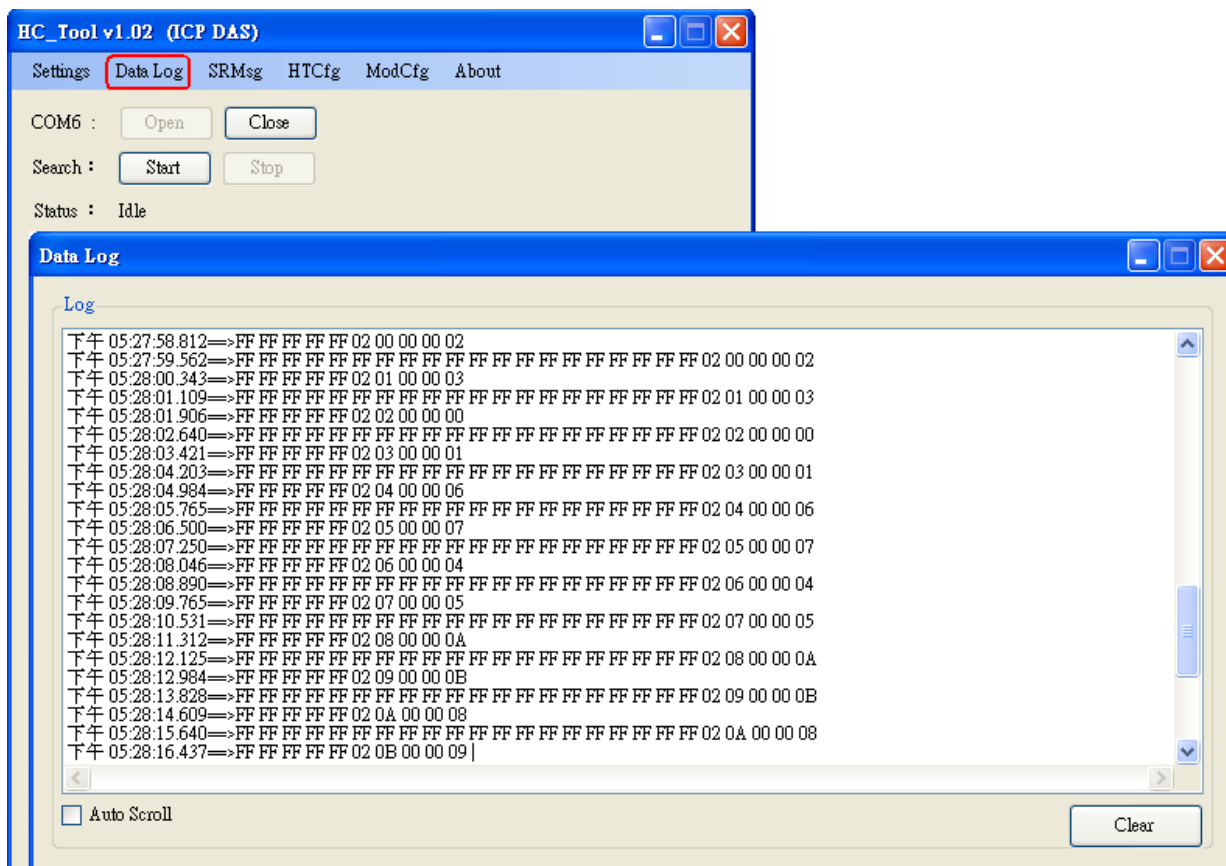

Figure 4-13: HART Information Log

4.6 HART Configuration (HTCfg)

When HART devices are searched in HC_Tool, then users can use “HTCfg” function to configure HART devices like Figure 4-14.

(Supported by HC_Tool v1.02 or newer)

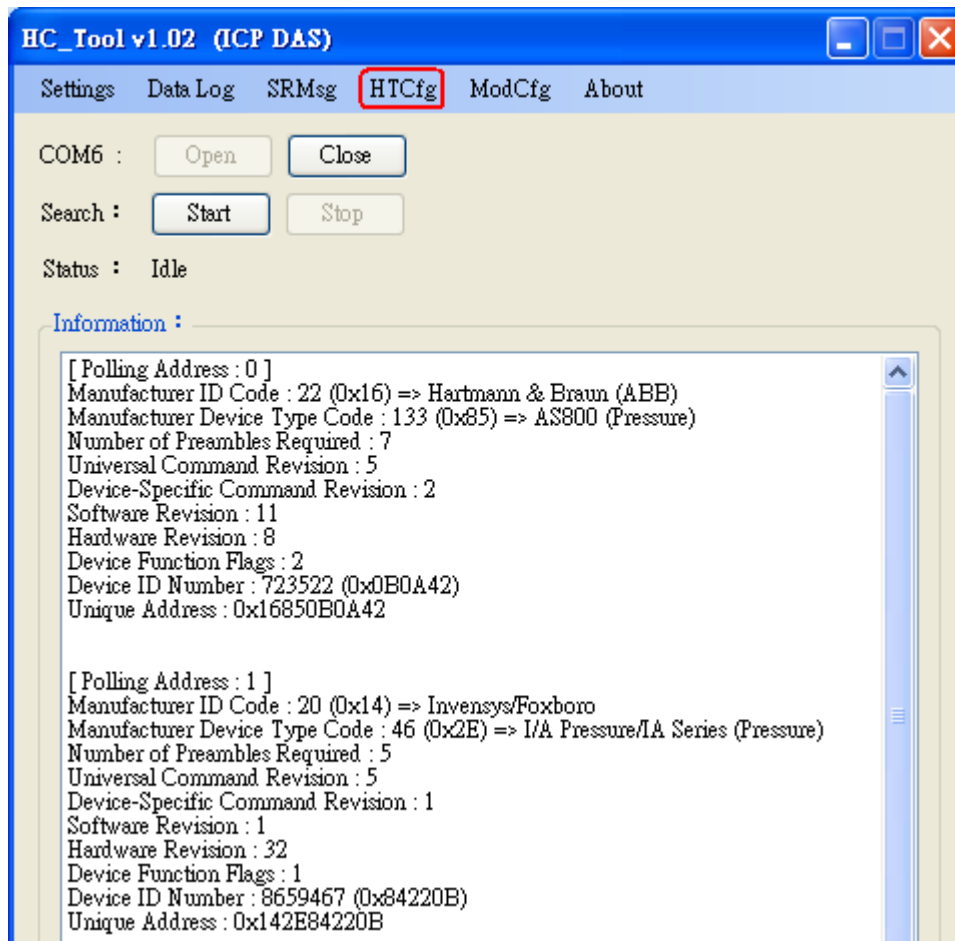

Figure 4-14: HTCcfg Item

The following is the function description of “HTCcfg” screen. (Like Figure 4-15)

- (1) “**DevAddr**” Field: Assign the HART device for configuration.
- (2) “**Response**” Field: Show the response message of HART configuration command.
- (3) “**Universal**” Page: Choose the “Universal” command for configuration.
(Support HART Command version v6.0)
- (4) “**Common**” Page: Choose the “Common-Practice” for configuration.
(Support HART Command version v6.0)
- (5) “**Start**” Button: Trig to send the HART configuration command.
- (6) “**Listen Mode**” item: Check it and click the ”Start” button, HC_Tool will listen HART bus and show the received HART message information.
- (7) “**HART RecvMsg Count**” Area: Show the total count of the received HART messages. (Including Master sending message and Slave response message)

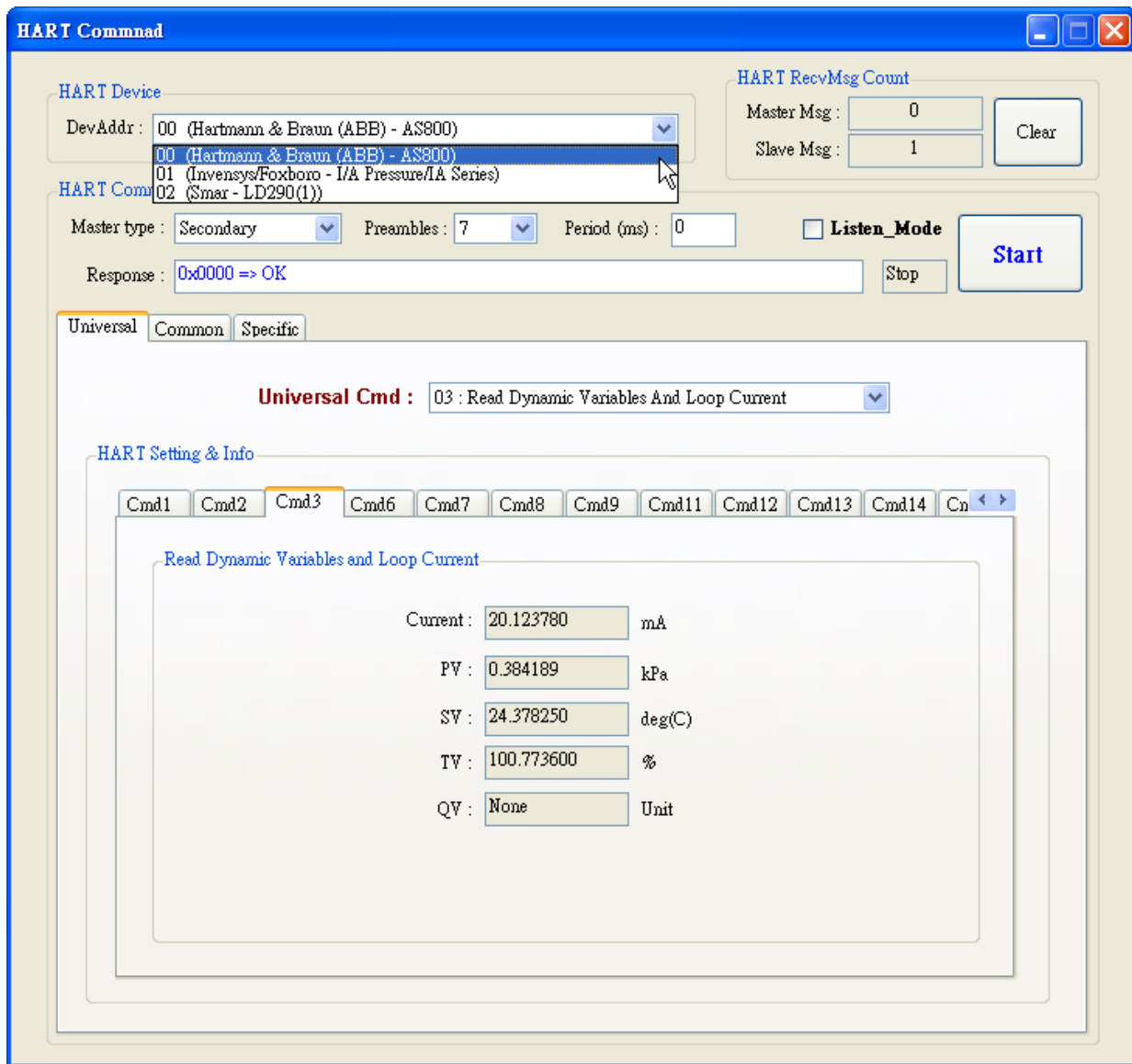

Figure 4-15: HTCfg Screen

4.7 Module Configuration (ModCfg)

Click "ModCfg" item, it will show the below two options to open the module configuration screen of HART Converter like Figure 4-16.

- (1) HC_Tool : v1.02 or newer supported.
- (2) I-7567 : FW_v1.5 or newer supported.
- (3) I-7570 : FW_v1.4 or newer supported

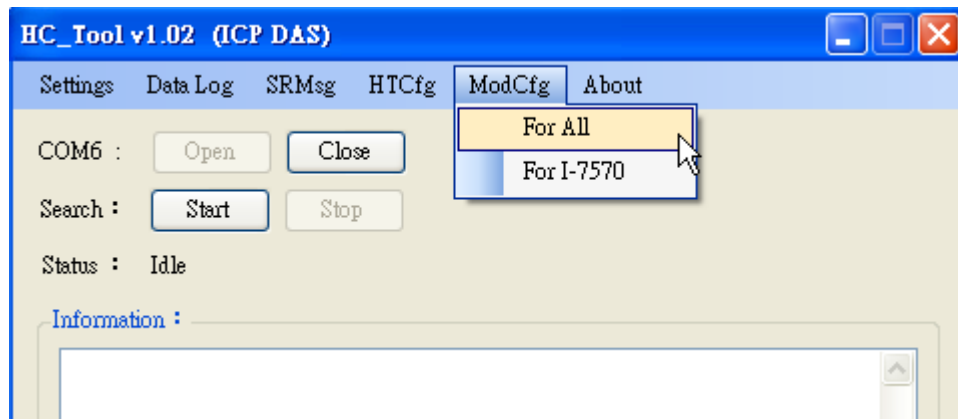

Figure 4-16: ModCfg Item

The following is the function description of “ModCfg”.

1. “For All” Option : (Like Figure 4-17)

Note : It is used for all HART Converter modules

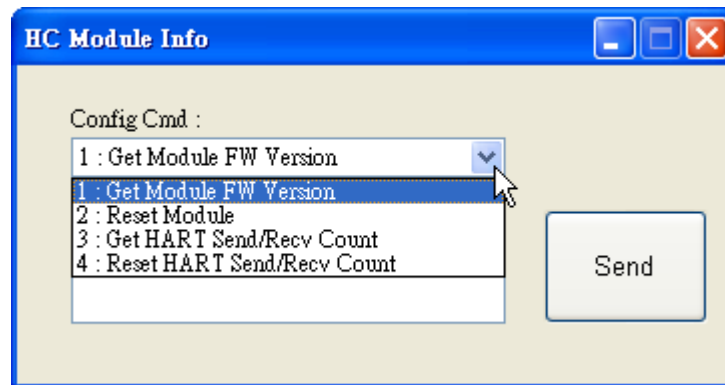

Figure 4-17: “For All” Option - Configuration Screen

(1) “Get Module FW Version”:

=> Return the firmware version of HART converter module.

(2) “Reset Module”:

=> Reset HART converter module.

(3) “Get HART Send/Recv Count”:

=> Return the total count of the sending and receiving HART messages in HART converter module.

(4) “Reset HART Send/Recv Count”:

=> Reset the total count of the sending and receiving HART messages in HART converter module.

2. “For I-7570” Option : (Like Figure 4-18)

Note : It is just used to I-7570 module and make sure the I-7570 must run in “Config Mode” first.

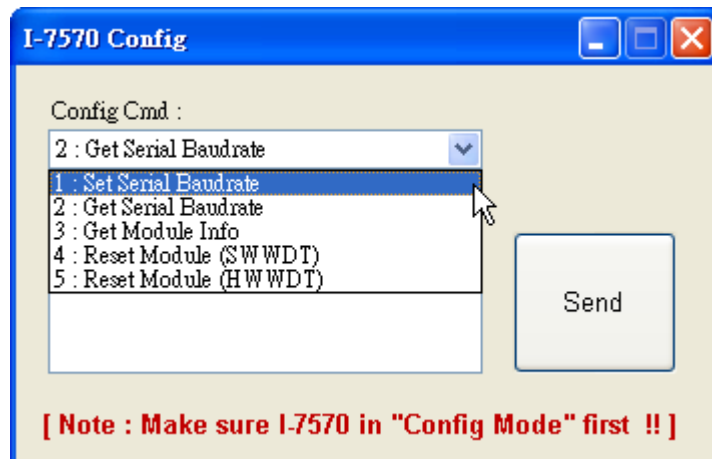

Figure 4-18: “For I-7570” Option - Configuration Screen

(1) “Set Serial Baudrate”:

=> Set the baudrate parameters of the serial port in I-7570.

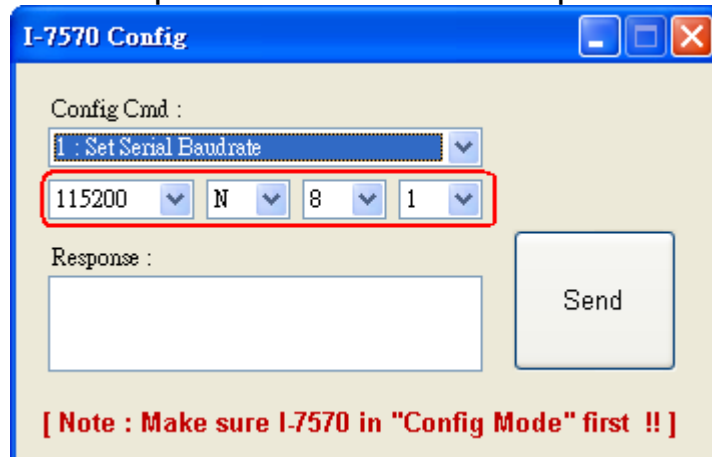

Figure 4-19: “Set Serial Baudrate” Function

(2) “Get Serial Baudrate”:

=> Get the baudrate parameters of the serial port in I-7570.

(3) “Get Module Info”:

=> Return the hardware information of I-7570. (Like: Firmware Version)

(4) “Reset Modue (SWWDT)”:

=> Reset I-7570. (Using Software WDT) ◦

(5) “Reset Modue (HWWDT)”:

=> Reset I-7570. (Using Hardware WDT) ◦

5. FAQ

Q01 : How to use I-7567 to communicate with HART devices ?

A01:

1. Install I-7567 “USB Driver” and it will create the virtual com port. (refer to chapter 3)
2. Run “HC_Tool” utility to communicate with HART devices. (refer to chapter 4)

Q02 : Does I-7567 support the API Library for HART ?

A02:

No, it doesn't. If users want to develop their own program to communicate with HART devices, please refer to the below suggestion.

- (1) Familiar with HART protocol => Using [HART Converter \(like: I-7567 / I-7570 / I-7547\)](#) to send / receive HART command by yourself.
- (2) Unfamiliar with HART protocol => Using [HART Gateway \(like: HRT-710 \(MB/RTU to HART\) or HRT-711 \(MB/TCP to HART\)\)](#) and users can easily and quickly access HART device information via Modbus communication.

Q03 : I-7567 driver installation for Windows10 ?

A03:

The detailed USB driver installation refers to the section 3.5.

Q04 : Set HART device address by using HART converter ?

A04: (2016/03/17)

Please follow the below steps.

- (1) Just connect one HART device to HART converter (like : I-7567 / I-7570 / I-7547).
- (2) Run “HC_Tool” software.
 - [1] Open the ComPort ◦
 - [2] Click the ”Start” button to search HART device automatically. As the below figure, the original address of the HART device is 0.

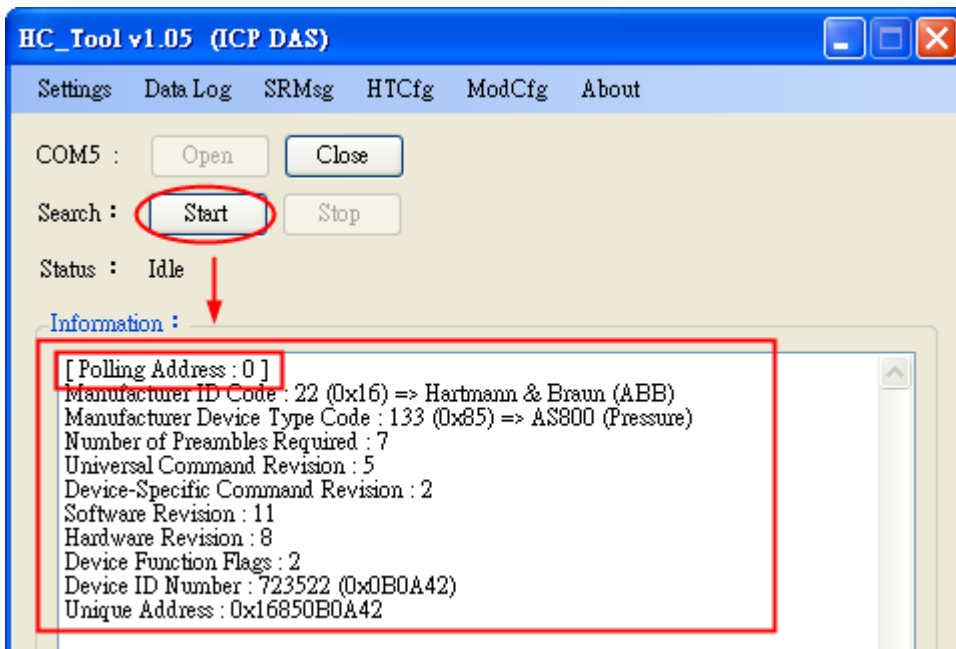

[3] Click the "HTCfg" button to open HART configuration page.

[4] Choose the "HART device" for configuration. In the "Universal" page, click the "Cmd6" option and users can choose the new address of HART device (Example : set to 1). Then click the "Start" button to set the new address.

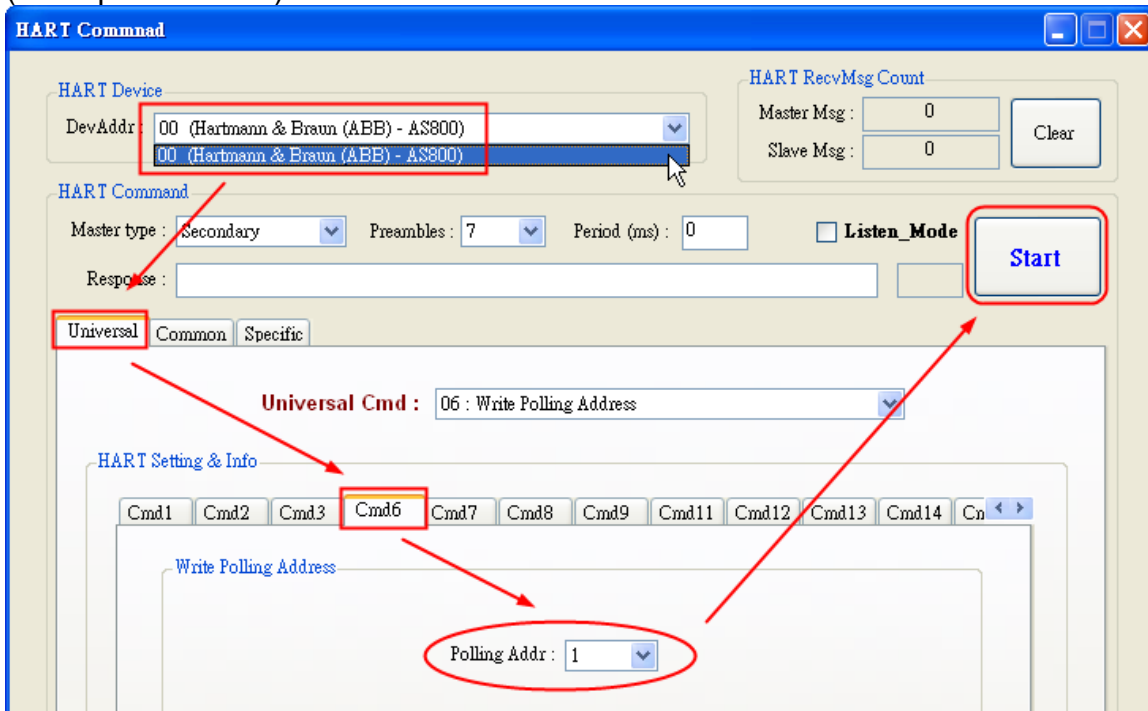

[5] After the setting for the new address is successful, the below message will show.

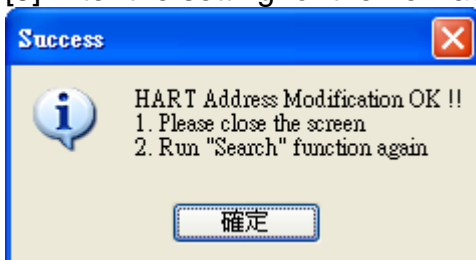

[6] Click the "Start" button in the main page to search HART device again. Then the address of the HART device will be 1 as the below figure.

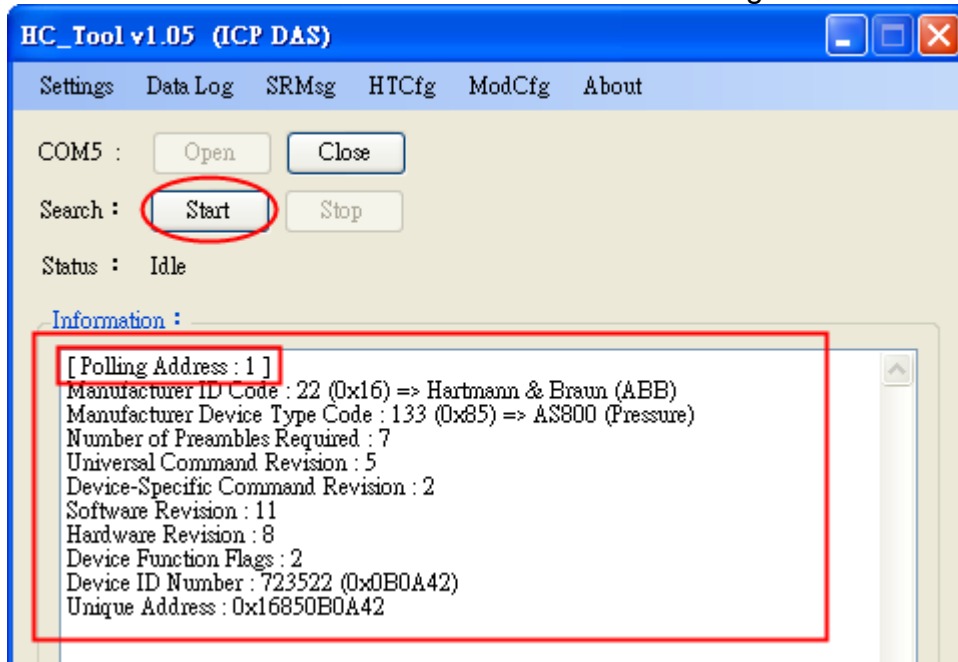

6. History Version

Ver.	Author	Date	Description
1.0	Bill	2011/03/17	1. First version
1.1	Edward	2012/03/02	1. Update content.
1.2	Edward	2012/12/20	1. Update FW to v1.5 [1] Add “Config” Function. 2. Update HC_Tool to v1.02 [1] Add “Config” screen. [2] Add HART v6.0 Universal and Common-Practice Command. [3] Add “Listen” HART communication Function.
1.3	Edward	2015/10/30	1. Add the FAQ chapter. 2. Add the section 3.5 for I-7567 driver Installation in Win10.
1.4	Edward	2016/09/07	1. Add the Q04 of FAQ. 2. Add driver installation for Windows x64. (section 3.3)