

# Software Guide

## ICP DAS LinPAC-8X81 Series SDK

---

Implement industry control with Linux Technique

### Warranty

All products manufactured by ICP DAS Inc. are warranted against defective materials for a period of one year from the date of delivery to the original purchaser.

### Warning

ICP DAS Inc. assume no liability for damages consequent to the use of this product. ICP DAS Inc. reserves the right to change this manual at any time without notice. The information furnished by ICP DAS Inc. is believed to be accurate and reliable. However, no responsibility is assumed by ICP DAS Inc. for its use, nor for any infringements of patents or other rights of third parties resulting from its use.

### Copyright

Copyright 2011-2014 by ICP DAS Inc. All rights are reserved.

### Trademark

The names used for identification only maybe registered trademarks of their respective companies.

### License

The user can use, modify and backup this software on **a single machine**. The user may not reproduce, transfer or distribute this software, or any copy, in whole or in part.

# Contents

1. Introduction.....	5
2. The LinPAC-8X81 Series SDK Introduction .....	11
3. The Architecture of LIBI8K.A in the LP-8X81 Series.....	13
4. LP-8X81 Series System Settings .....	15
4.1 Settings for the LP-8X81 Series Network.....	17
4.1.1 Setting the IP 、Netmask and Gateway	17
4.1.2 Setting of DNS	21
4.2 CF (Compact Flash) Card Usage .....	21
4.2.1 Recover OS by CF card	22
4.3 USB Device Usage.....	22
4.3.1 Mount USB Device	22
4.3.2 Umount USB Device	23
4.4 System Language .....	23
4.5 VGA Resolution.....	23
4.6 Make a new CF card to recover LP-8x81 Series OS .....	25
4.7 Running applications automatically at boot time.....	26
4.8 Set up OS filesystem check (fsck) at boot time .....	27
5. Instructions for the LP-8X81 Series.....	28
5.1 Basic Linux Instructions.....	28
5.1.1 Linux Command “ls”	28
5.1.2 Linux Command “cd”	29
5.1.3 Linux Command “mkdir”	29
5.1.4 Linux Command “rmdir”	29
5.1.5 Linux Command “rm”	29
5.1.6 Linux Command “cp”	30
5.1.7 Linux Command “mv”	30
5.1.8 Linux Command “pwd”	30
5.1.9 Linux Command “who”	30
5.1.10 Linux Command “chmod”	30
5.1.11 Linux Command “uname”	31
5.1.12 Linux Command “ps”	31

5.1.15 Linux Command “date”	31
5.1.16 Linux Command “netstat”	31
5.1.17 Linux Command “ifconfig”	31
5.1.18 Linux Command “wget”	31
5.1.19 Linux Command “ping”	31
5.1.19 Linux Command “clear”	31
5.1.20 Linux Command “passwd”	32
5.1.21 Linux Command “reboot”	32
5.2 A Simple Example – Helloworld.c .....	32
5.3 i-Talk Utility.....	37
<b>6. LIBI8K.A .....</b>	<b>42</b>
6.1 System Information Functions .....	43
6.2 Digital Input/Output Functions .....	48
6.3 Watch Dog Timer Functions .....	63
6.4 EEPROM Read/Write Functions.....	66
6.5 Analog Input Functions .....	69
6.6 Analog Output Functions .....	82
6.7 The Software Develop Toolkit Error Code .....	86
<b>7. Demo of LP-8X81 Series Modules With C Language .....</b>	<b>88</b>
7.1 I-7k Modules DIO Control Demo .....	88
7.2 I-7k Modules AIO Control Demo .....	90
7.3 I-87k Modules DIO Control Demo .....	93
7.3.1 I-87k Modules in slots of LP-8X81 Series	93
7.3.2 I-87k Modules in slots of I-87k I/O expansion unit	95
7.3.3 I-87k Modules in slots of I-8000 Controller	98
7.4 I-87k Modules AIO Control Demo .....	98
7.4.1 I-87k Modules in slots of LP-8X81 Series	98
7.4.2 I-87k Modules in slots of I-87k I/O expansion unit	100
7.4.3 I-87k Modules in slots of I-8000 Controller	103
7.5 I-8k Modules DIO Control Demo .....	103
7.5.1 I-8k Modules in slots of LP-8X81 Series	103
7.5.2 I-8k Modules in slots of I-8000 Controller	105
7.6 I-8k Modules AIO Control Demo .....	107
7.6.1 I-8k Modules in slots of LP-8X81 Series	107
7.6.2 I-8k Modules in slots of I-8000 Controller	110
7.7 Conclusion of Module Control Demo .....	112

<b>8. LP-8X81 Series Library Reference in C Language .....</b>	<b>114</b>
8.1 List Of System Information Functions.....	114
8.2 List Of Digital Input/Output Functions.....	114
8.3 List Of Watch Dog Timer Functions .....	115
8.4 List Of EEPROM Read/Write Functions .....	115
8.5 List Of Analog Input Functions.....	115
8.6 List Of Analog Output Functions .....	116
<b>9. Additional Support .....</b>	<b>117</b>
9.1 N-Port Serial Port and Modules Driver Install.....	117
9.2 N-Port Module (i-8114w or other serial modules) Support.....	118
9.3 Rescue Disk.....	119
9.4 GUI Funtion Support.....	121
9.4.1 How to boot LP-8X81 Series without loading X-window	121
9.4.2 Enabling X-window load at boot time	122
9.5 Application Support .....	122
9.6 Other Optional Function.....	124
<b>Appendix A. Service Information .....</b>	<b>127</b>
Internet Service : .....	127
Manual Revision: .....	128

---

## 1. Introduction

---

Linux has been adopted widely by many users because of the properties of stability, open source, and free charge. Meanwhile, Linux is supported by many large international companies and the function in Linux is not inferior to Windows so that Linux OS is more and more popular and accepted. In the other hand, the hardware requirement that Linux OS can works in embedded system smoothly is not high, just only 386 CPU or better and 8 MB RAM. Therefore except Win CE of Microsoft, Linux has been already another good choice in embedded OS.

The Linux OS demands less system resources from the embedded controller and is therefore the best fit for it because of the embedded controller has some limitations in system resources. It is for this reason that the LP-8X81 Series embedded controller has been published to be a new generation product from ICP DAS and the Embedded-Linux OS has been adopted into the LP-8X81 Series. The main purpose of LP-8X81 Series is to allow the numerous enthusiastic Linux users to control their own embedded systems easily within the Linux Environment.

ICP DAS provides the library file - libi8k.a which includes all the functions from the I-7000/8000/87000 series modules which are used in the LP-8X81 Series Embedded Controller. The libi8k.a is designed especially for the I-7000/8000/87000 series modules on the Linux platform for use in the LP-8X81 Series. Users can easily develop applications in the LP-8X81 Series by using either C Language In the future. The various functions of the libi8k.a are divided into the sub-group functions for ease of use within the different applications. The powerful functions of the LP-8X81 Series

embedded controller, which includes a **VGA**, **USB (Card Reader, Camera ...)**, **Mouse**, **Audio**, **Keyboard**, **Serial ports (RS-232, RS-422/485)**, **Ethernet (Hub...)** and **many I/O slots** in the picture. Presently, HTTP、SSH Servers are built in and users can transfer files or use remote control with the LP-8X81 Series more conveniently In network communication. Fig. 1-1 illustrates hardware architecture of the LP-8X81 Series.

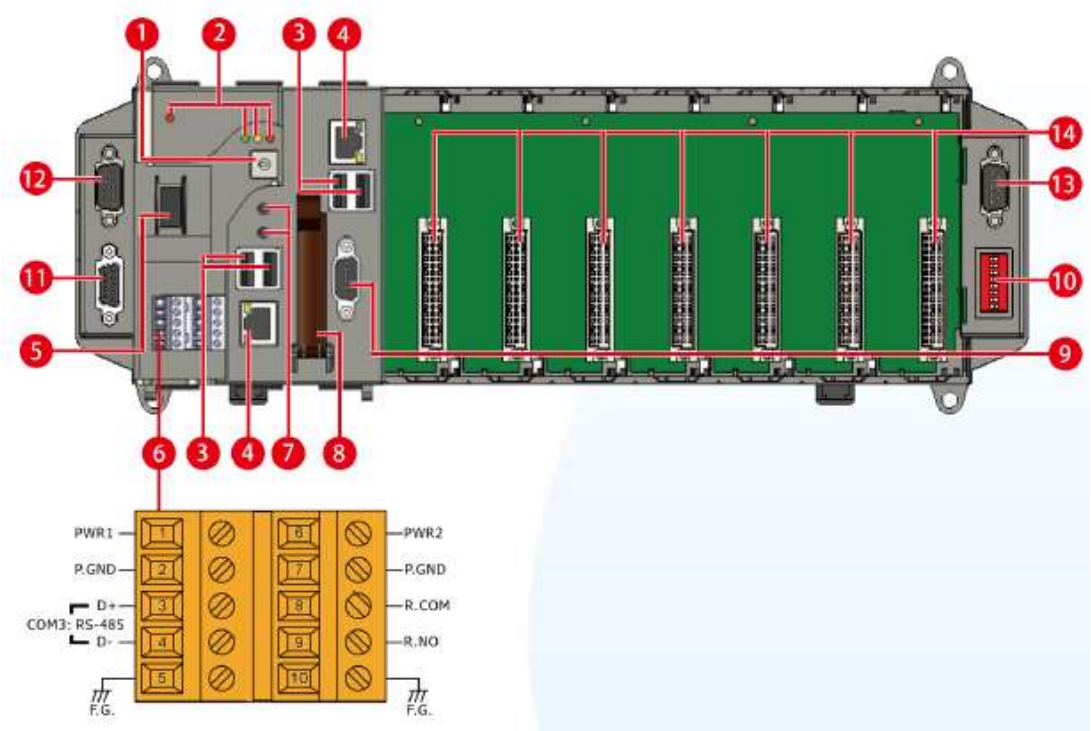

Fig. 1-1

**1. Rotary Switch**

The Rotary Switch is an operating mode selector switch which provides functions to configure with the selection of operating mode and authorization control.

**2. LED Indicators**

The LP-8X81 contains PWR LED indicators that located near power switch and show the power status.

The LP-8X81-Atom contains four LED indicators. The first is labeled PWR, located

near the power switch and show the power status. The three other are located next the rotary switch, the left one is labeled RUN and show the operation status, the two other are denoted L1 and L2 and used for user defined.

LED Indicators	Color	Meaning
PWR	Red	Power is on
RUN	Green	OS is running
L1	Yellow	User programmable LED
L2	Red	User programmable LED

### 3. USB Ports

The LP-8X81 contains two USB ports that allow support for the USB devices such as mouse, keyboard or an external USB hard drive. These ports are denoted P1 and P2.

The LP-8X81-Atom contains four USB ports. These ports are denoted P1, P2, P3 and P4.

### 4. Ethernet Ports

The LP-8X81 Series contains two Ethernet ports for use with network devices, and is denoted as LAN1 and LAN2.

### 5. Power Switch

The power switch is a small switch that enables or disables power to electric circuits and loads in the LP-8X81 Series.

### 6. Connector

The connector has 10 pins arranged in 2 rows, as follows:  
The pin assignments of the connector are as follows:

Pin	Signal	Description
1	PWR1	Power input 1
2	P.GND	

3	D+	COM3:RS485
4	D-	
5	F.G.	Frame ground
6	PWR2	Power input 2
7	P.GND	
8	R.COM	Relay Output
9	R.NO	
10	F.G.	Frame ground

## 7. Microphone and Earphone

The LP-8X81-Atom contains the microphone and earphone jack to the input and output of sound system.

## 8. CF(Compact Flash) Card Slot

The CF card expansion slot is an interface that is used to access and download information on a CF card to a LP-8X81 Series. The CF card can be used to expand the memory up to 32 GB.

## 9. VGA Connector

A VGA connector is a 3-row 15-pin connector that can be used with a variety of supported VGA resolutions.

## 10. DIP Switch(Only for LP-8181-Atom, LP-8381-Atom and LP-8781-Atom)

The DIP switch can be used to set the Module ID to a number from 0 to 255. Do not use Module ID 0 for communication.



### 11.COM2(RS232)

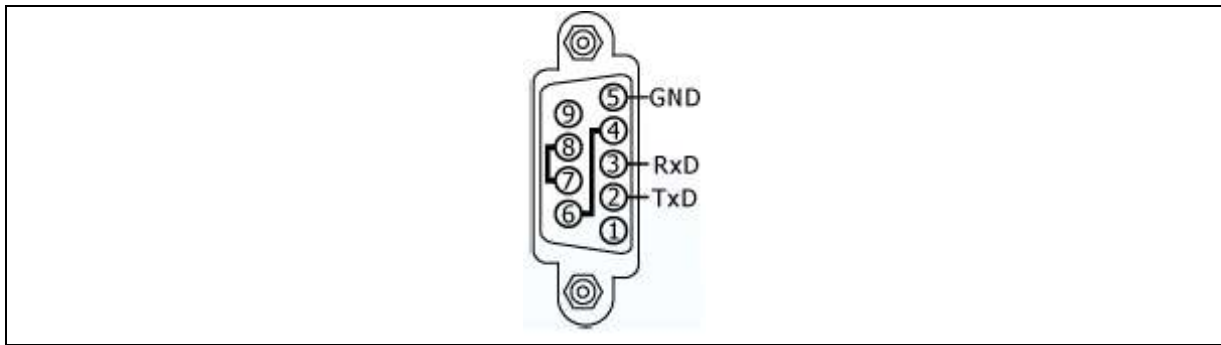

<b>Port Type</b>	Female
<b>Baud Rate</b>	115200, 57600, 38400, 19200, 9600, 4800, 2400, 1200 bps
<b>Data Bits</b>	7, 8
<b>Parity</b>	None, Even, Odd
<b>Stop Bits</b>	1
<b>FIFO</b>	1 byte

### 12.COM4(RS232/RS485)

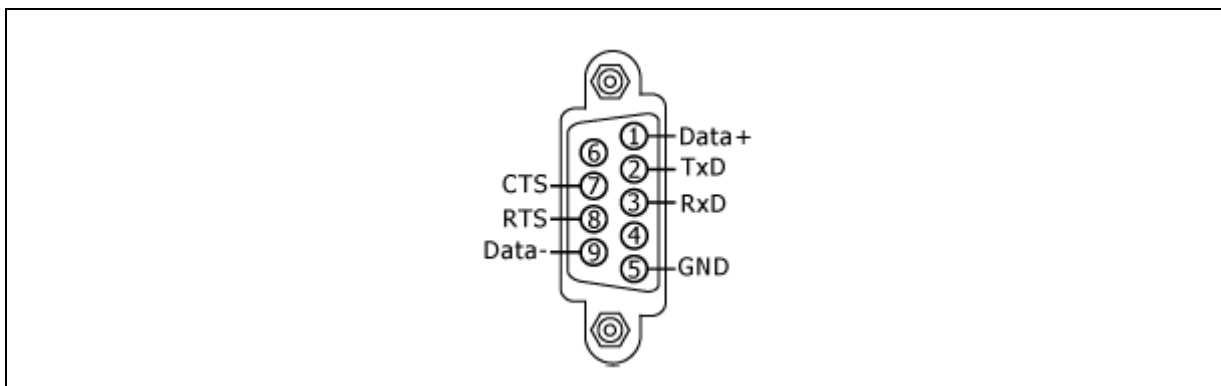

<b>Port Type</b>	Male
<b>Baud Rate</b>	115200, 57600, 38400, 19200, 9600, 4800, 2400, 1200 bps
<b>Data Bits</b>	5, 6, 7, 8
<b>Parity</b>	None, Even, Odd, Mark (Always 1), Space (Always 0)

### 13.COM5(RS232)

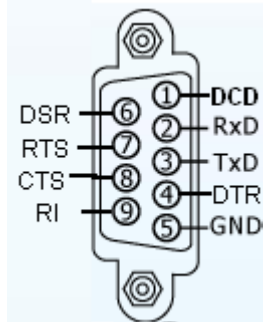

<b>Port Type</b>	Male
<b>Baud Rate</b>	115200, 57600, 38400, 19200, 9600, 4800, 2400, 1200 bps
<b>Data Bits</b>	5, 6, 7, 8
<b>Parity</b>	None, Even, Odd, Mark (Always 1), Space (Always 0)
<b>Stop Bits</b>	1, 2
<b>FIFO</b>	16 bytes

#### 14. PAC I/O Slots

The LP-8X81 Series contains some extra I/O slots.

The LP-8X81 Series use I/O slots that can be expanded. They can serve in local and local expansion. The number of each type of the expansion I/O slot:

LP-8081: 0 I/O slot.

LP-8181-Atom: 1 I/O slot.

LP-8381 & LP-8381-Atom: 3 I/O slots.

LP-8181 & LP-8781-Atom: 7 I/O slots.

---

## 2. The LinPAC-8X81 Series SDK Introduction

---

LP-8X81 Series SDK consists of the following major items.

- LinPAC SDK library files
- LinPAC SDK include files
- Demo files

From <http://ftp.icpdas.com/pub/cd/linpac/napdos/lp-8x8x/atom/>, you can download the latest version of LP-8X81 Series SDK and the Manual. And then follows the below steps in order to get the development toolkit which has been provided by ICP DAS for the easy application of the LP-8X81 Series embedded controller platform.

(1) User can connect to LP-8X81 Series through **Ethernet 1**, **Ethernet 2** by using the command “**telnet**” (refer to Fig 4-1, Fig 4-2) **or by using “putty”** software (refer to Fig 4-3, Fig 4-4).

(2) After user connect to LP-8X81 Series, user could type command “wget

[http://ftp.icpdas.com/pub/cd/linpac/napdos/lp-8x8x/atom/sdk/linpac-8x81\\_sdk.tar.g](http://ftp.icpdas.com/pub/cd/linpac/napdos/lp-8x8x/atom/sdk/linpac-8x81_sdk.tar.gz)  
z” to get the latest version of LP-8X81 series SDK.

(3) To type “tar xzf linpac-8X81\_sdk.tar.gz” to decompress tar file (refer to Fig 2-1).

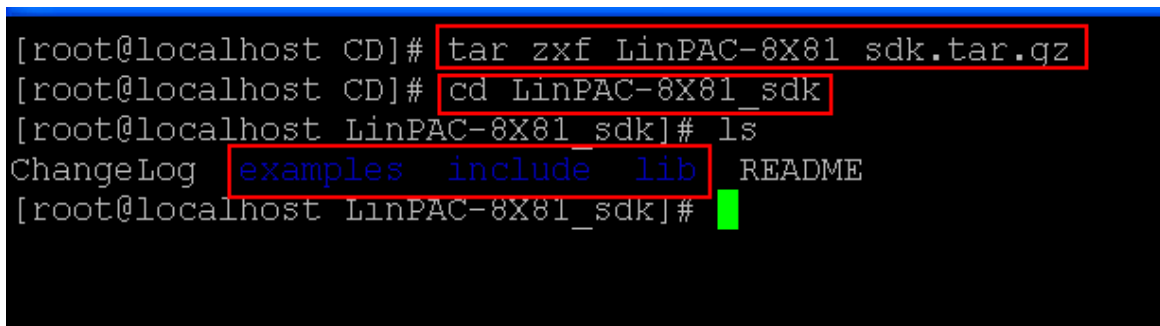

```
[root@localhost CD]# tar xzf LinPAC-8X81_sdk.tar.gz
[root@localhost CD]# cd LinPAC-8X81_sdk
[root@localhost LinPAC-8X81_sdk]# ls
ChangeLog  examples  include  lib  README
[root@localhost LinPAC-8X81_sdk]#
```

Fig 2-1

Once user decompresses the SDK file, user can find the files for the library and demo in the following paths.

The Libi8k.a path is “**LinPAC-8X81\_sdk\lib**”.

The include files path is “**LinPAC-8X81\_sdk\include**”.

The demo path is “**LinPAC-8X81\_sdk\examples**”.

---

### 3. The Architecture of LIBI8K.A in the LP-8X81 Series

---

The **libi8k.a** is a library file that is designed for I7000/8000/87000 applications running in the LP-8X81 series Embedded Controller using the Linux OS. Users can apply it to develop their own applications **with GNU C language**. In order to assist users to build their project quickly, we provide many demo programs. Based on these demo programs, users can easily understand how to use these functions and develop their own applications within a short period of time.

The relationships among the libi8k.a and user's applications are depicted as Fig. 3-1 :

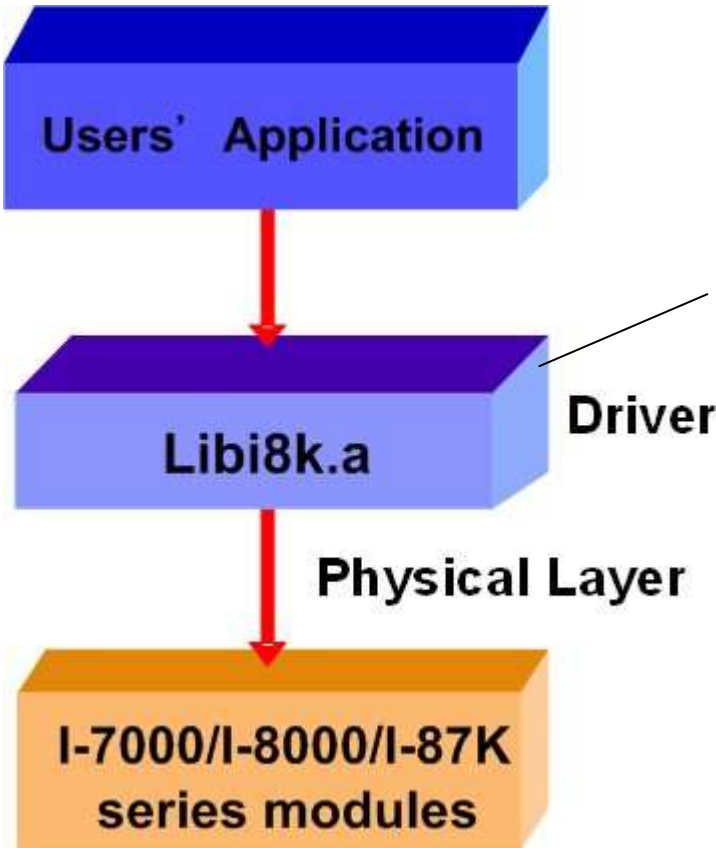

Fig. 3-1

Functions for LP-8X81 Series Embedded Controller are divided into sub-groups for ease of use within the different applications :

System Information Functions

Digital Input Functions

Digital Output Functions

Watch Dog Timer Functions

EEPROM Read/Write Functions

Analog Input Functions

Analog Output Functions

The functions in the Libi8k.a are especially designed for LP-8X81 Series. Users can easily find the functions they need for their applications from the descriptions in chapter 6 and in the demo programs provided in chapter 7.

---

## 4. LP-8X81 Series System Settings

---

User can use the three methods to connect to LP-8X81 Series to configure system, check system status and startup/stop system service:

(1) To connect to LP-8X81 Series through serial port “COM2” by using Windows communication software “Hyper Terminal” (baud rate is 38400).

(2) To connect to LP-8X81 Series through Ethernet port by using command “telnet” (please refer to Fig 4-1, 4-2). The default ID is “root” and password is “icpdas”.

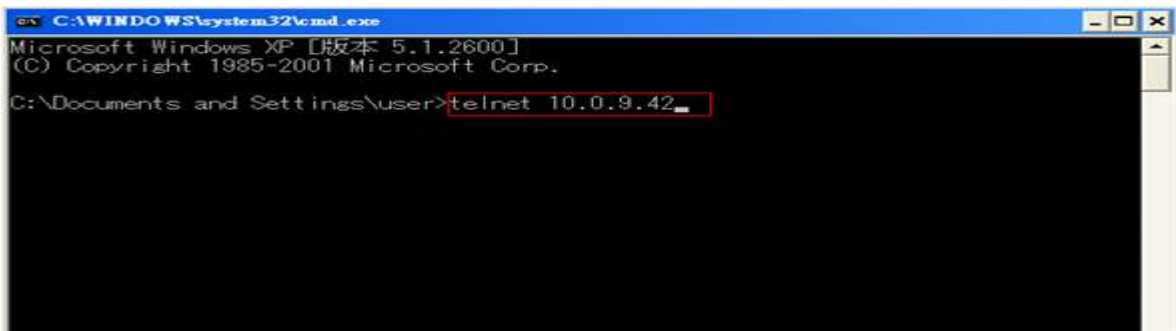

Fig 4-1

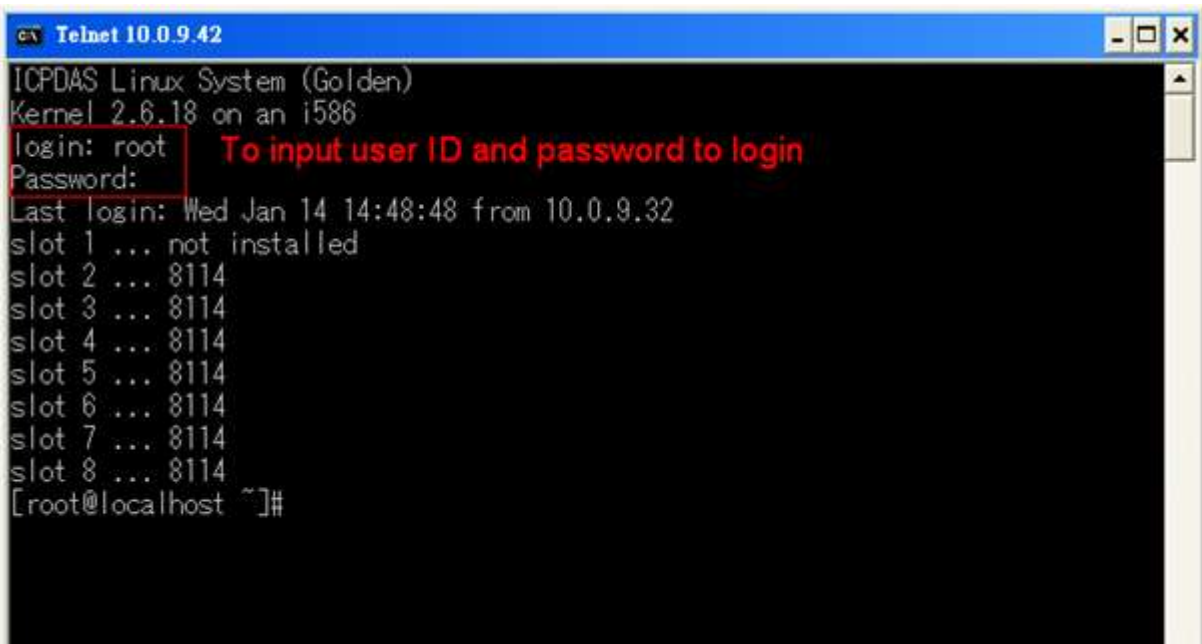

Fig 4-2

(3) To connect to LP-8X81 Series through Ethernet Port by using “Putty” software (please refer to Fig 4-3, Fig 4-4). The default ID is “root” and password is “icpdas”.

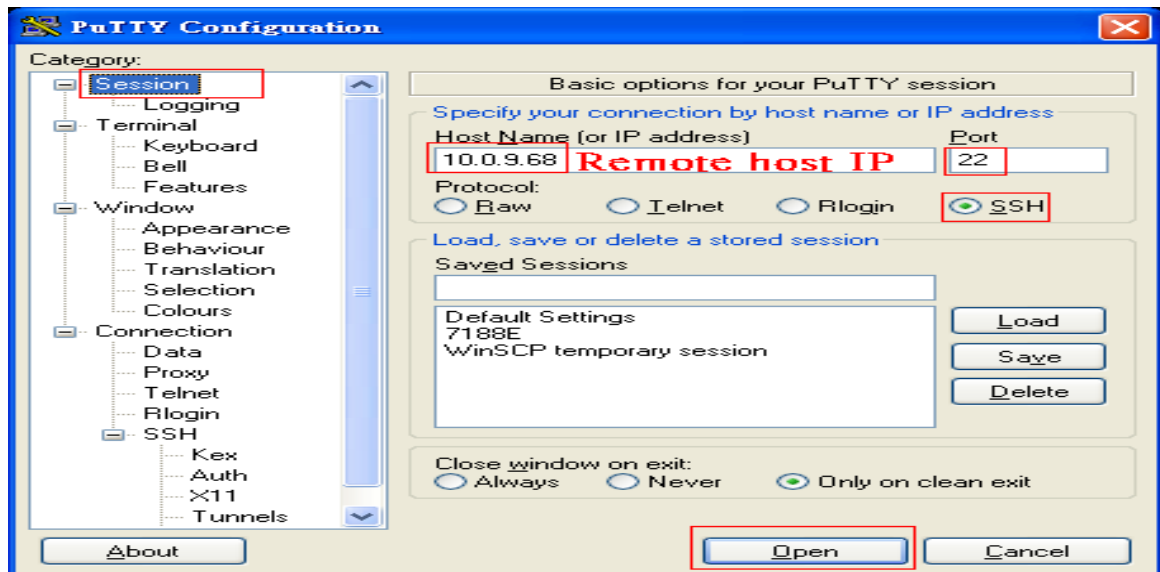

Fig 4-3

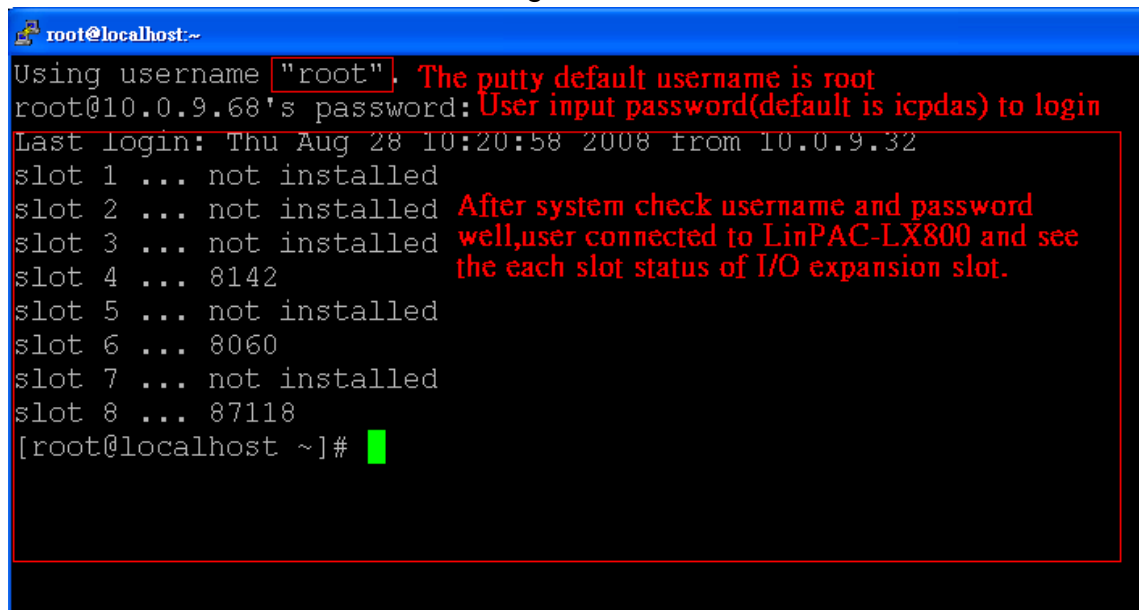

Fig 4-4

In this section, we will introduce how to setup the LP-8X81 Series configuration. Let users can use the LP-8X81 Series more easily.



## 4.1 Settings for the LP-8X81 Series Network

The LP-8X81 Series network setting includes two ways. One is **DHCP** and the other is “**Assigned Static IP**”. DHCP is the default setting after the LP-8X81 Series is produced and this way is easy for users. However, if your network system is without DHCP server, then users need to configure the network setting by using “Assigned IP”.

### 4.1.1 Setting the IP 、 Netmask and Gateway

(1) Using DHCP:

Boot up LP-8X81 Series and use “telnet” to open a “**linux command Prompt**”.

Type in “**vi /etc/sysconfig/network** ” to open the network setting file.

Please refer to the Fig 4-5:

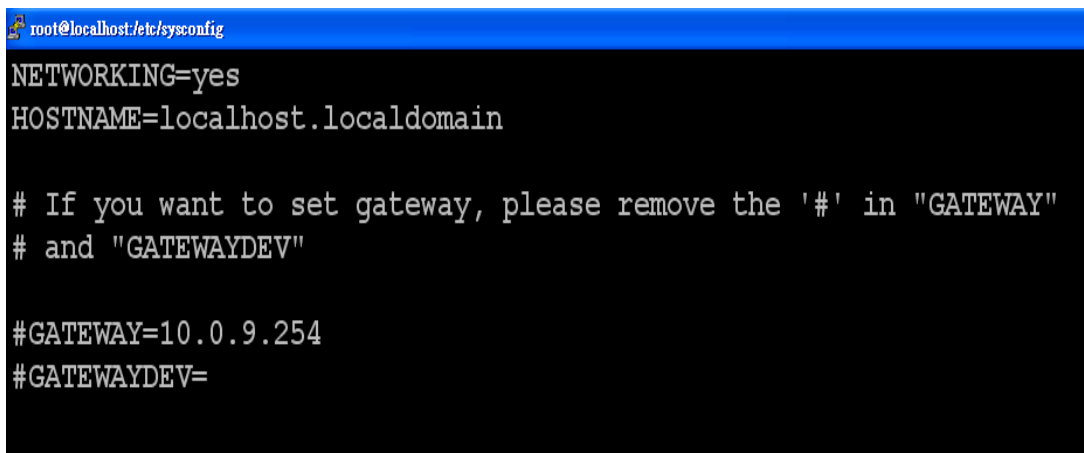

```
root@localhost:/etc/sysconfig
NETWORKING=yes
HOSTNAME=localhost.localdomain

# If you want to set gateway, please remove the '#' in "GATEWAY"
# and "GATEWAYDEV"

#GATEWAY=10.0.9.254
#GATEWAYDEV=
```

Fig 4-5

After editing the “network” file, user can type in “**vi /etc/sysconfig/network-scripts/ifcfg-eth0**” and “**vi /etc/sysconfig/network-scripts/ifcfg-eth1**” to set the network device “**eth0**” and “**eth1**”. To remove “**#**” in the dhcp block and add “**#**” in the Assign IP block. Then type “**:wp**” to save the setting. To type “**/etc/init.d/ifplugd restart** ” to make the setting work. Please refer to the Fig 4-6 and Fig 4-7.

```
root@localhost:/etc/sysconfig/network-scripts
DEVICE=eth0
BOOTPROTO=dhcp
HWADDR=00:10:F3:12:BB:94
ONBOOT=yes
TYPE=Ethernet

#DEVICE=eth0
#BOOTPROTO=static
#BROADCAST=10.0.9.255
#IPADDR=10.0.9.68
#NETMASK=255.255.255.0
#NETWORK=10.0.9.0
#ONBOOT=yes
#TYPE=Ethernet

~
~
:wq
```

The config of DHCP

The config of Static IP

Fig 4-6

```
root@localhost:/etc/sysconfig/network-scripts
DEVICE=eth1
BOOTPROTO=dhcp
HWADDR=00:10:F3:12:BB:99
ONBOOT=yes
TYPE=Ethernet

#DEVICE=eth1
#BOOTPROTO=static
#BROADCAST=10.0.9.255
#IPADDR=10.0.9.15
#NETMASK=255.255.255.0
#NETWORK=10.0.9.0
#ONBOOT=yes
#TYPE=Ethernet

~
~
:wq
```

The config of DHCP

The config of Static IP

Fig 4-7

(2) Using “Assigned IP”:

Boot up LP-8X81 Series and open a “**command Prompt**”. Type in “**vi /etc/sysconfig/network**” to open the network setting file. If user wants to set gateway, user can remove “**#**” in the “**GATEWAY**” and “**GATEWAYDEV**”. Please refer to the Fig 4-8:

```
root@localhost:/etc/sysconfig
NETWORKING=yes
HOSTNAME=localhost.localdomain

# If you want to set gateway, please remove the '#' in "GATEWAY"
# and "GATEWAYDEV"

GATEWAY=10.0.9.254
GATEWAYDEV=
```

To remove '#' to set the gateway.

Fig 4-8

After editing the “network” file, user can type in “vi /etc/sysconfig/network-scripts/ifcfg-eth0” and “vi /etc/sysconfig/network-scripts/ifcfg-eth1” to set the network device “eth0” and “eth1”. To add “#” in the dhcp block and remove “#” in the Assign IP block. Then type “:wq” to save the setting. To type “/etc/init.d/ifplugd restart” to make the setting work. Please refer to the Fig 4-9 and Fig 4-10:

```
root@localhost:/etc/sysconfig/network-scripts
#DEVICE=eth0
#BOOTPROTO=dhcp
#HWADDR=00:10:F3:12:BB:94
#ONBOOT=yes
#TYPE=Ethernet

DEVICE=eth0
BOOTPROTO=static
BROADCAST=10.0.9.255
IPADDR=10.0.9.68
NETMASK=255.255.255.0
NETWORK=10.0.9.0
ONBOOT=yes
TYPE=Ethernet

:wq
```

The config of DHCP

The config of Static IP

Fig 4-9

```

root@localhost:/etc/sysconfig/network-scripts
#DEVICE=eth1
#BOOTPROTO=dhcp
#HWADDR=00:10:F3:12:BB:99
#ONBOOT=yes
#TYPE=Ethernet

DEVICE=eth1
BOOTPROTO=static
BROADCAST=10.0.9.255
IPADDR=10.0.9.15
NETMASK=255.255.255.0
NETWORK=10.0.9.0
ONBOOT=yes
TYPE=Ethernet

~
:wq

```

The config of DHCP

The config of Static IP

Fig 4-10

After finishing the LinPAC network setting, user can type “ **ifconfig** “ to see the network setting. (Refer to the Fig 4-11)

```

[root@localhost ~]# ifconfig
eth0      Link encap:Ethernet  HWaddr 00:10:F3:12:BB:92
          inet addr:10.0.9.68  Bcast:10.0.9.255  Mask:255.255.255.0
          UP BROADCAST RUNNING MULTICAST  MTU:1500  Metric:1
          RX packets:14208 errors:0 dropped:0 overruns:0 frame:0
          TX packets:4033 errors:0 dropped:0 overruns:0 carrier:0
          collisions:0 txqueuelen:1000
          RX bytes:1436281 (1.3 MiB)  TX bytes:479736 (468.4 KiB)
          Interrupt:7 Base address:0x4000

eth1      Link encap:Ethernet  HWaddr 00:10:F3:12:BB:93
          inet addr:10.0.9.15  Bcast:10.0.9.255  Mask:255.255.255.0
          UP BROADCAST RUNNING MULTICAST  MTU:1500  Metric:1
          RX packets:15253 errors:0 dropped:0 overruns:0 frame:0
          TX packets:260 errors:0 dropped:0 overruns:0 carrier:0
          collisions:0 txqueuelen:1000
          RX bytes:1543038 (1.4 MiB)  TX bytes:9260 (9.0 KiB)
          Interrupt:15 Base address:0x6000

lo        Link encap:Local Loopback
          inet addr:127.0.0.1  Mask:255.0.0.0
          UP LOOPBACK RUNNING  MTU:16436  Metric:1
          RX packets:220 errors:0 dropped:0 overruns:0 frame:0
          TX packets:220 errors:0 dropped:0 overruns:0 carrier:0
          collisions:0 txqueuelen:0
          RX bytes:5088 (4.9 KiB)  TX bytes:5088 (4.9 KiB)

```

Fig 4-11

## 4.1.2 Setting of DNS

Boot up LP-8X81 Series and open “command line”. Type in “ vi /etc/resolv.conf” to open the DNS setting file. Type “ DNS server ” in the “ nameserver “ field. Then type “ :wq ” to save the setting. Type “ reboot “ to reboot the LP-8X81 Series to make the setting work. (Refer to the Fig 4-12)

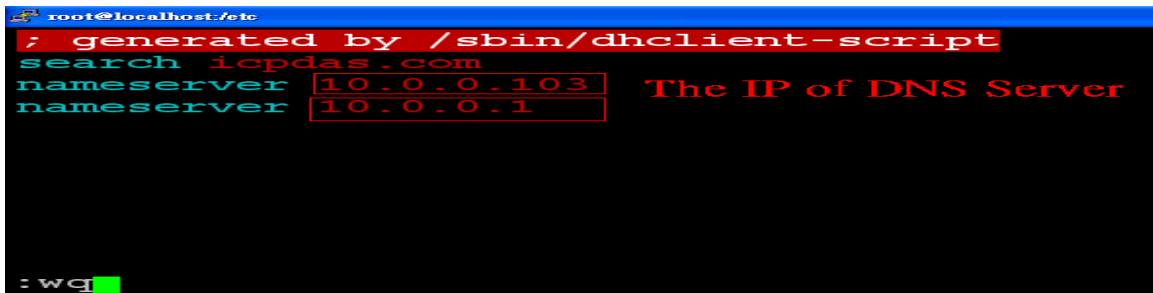

```
root@localhost:/etc
; generated by /sbin/dhclient-script
search icpdas.com
nameserver 10.0.0.103
nameserver 10.0.0.1
:wq
```

Fig 4-12

## 4.2 CF (Compact Flash) Card Usage

Before you startup the LixPAC-8000 system, you can insert the CF Card into the slot of CF Card in the LP-8X81 Series. Then user can use the command “fdisk -l” to check the device name of CF card in the LP-8X81 Series. Therefore, users can access the CF Card in the LP-8X81 Series by using the command “mount” and “umount”. Please refer to the Fig 4-13:

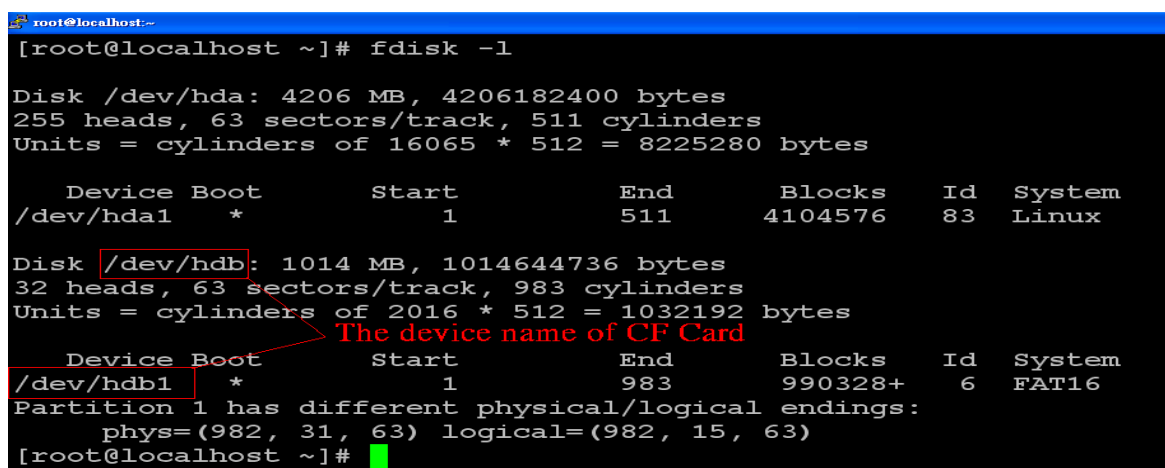

```
root@localhost~
[root@localhost ~]# fdisk -l

Disk /dev/hda: 4206 MB, 4206182400 bytes
255 heads, 63 sectors/track, 511 cylinders
Units = cylinders of 16065 * 512 = 8225280 bytes

   Device Boot           Start      End  Blocks    Id System
/dev/hda1 *                1       511    4104576   83  Linux

Disk /dev/hdb: 1014 MB, 1014644736 bytes
32 heads, 63 sectors/track, 983 cylinders
Units = cylinders of 2016 * 512 = 1032192 bytes

   Device Boot           Start      End  Blocks    Id System
/dev/hdb1 *                1       983    990328+    6  FAT16

Partition 1 has different physical/logical endings:
   phys=(982, 31, 63) logical=(982, 15, 63)
[root@localhost ~]#
```

Fig 4-13

## 4.2.1 Recover OS by CF card

Follow below steps to recover LinPAC device OS.

1. Insert CF card and power on LinPAC-8X81 Series.
2. Adjust your boot priority.

LP-8x81 series device

- (1) Type delete button to get in BIOS menu.
- (2) Enter "Advanced BIOS Features"
- (3) Set "First Boot Device" to "HDD-1"

LP-8x81-Atom series device

- (1) Type delete button to get in BIOS menu.
- (2) Enter "Boot"
- (3) Enter "Hard Disk Drives"
- (4) Set "1st Drive" to "SATA:PS-CF Card"

3. Boot in CF card, you can type "df -h" to check device name is /dev/hdb1(or /dev/sdb1).
4. Type "setup-control" to start recovering OS.

## 4.3 USB Device Usage

Before accessing the USB device, users need to mount the USB device to the LP-8X81 Series. Because it will not auto-mount the USB device in the LP-8X81 Series. After Users mount the USB device (ex USB disk) to the LP-8X81 Series, they can access the USB device.

### 4.3.1 Mount USB Device

The steps are as follows:

- (1) Type " **mkdir /mnt/usb** " to build a usb directory.
- (2) Type " **mount /dev/sda1 /mnt/usb** " to mount the USB device to the usb directory and type " **ls /mnt/usb** " to see the content of USB device.

### 4.3.2 Umount USB Device

Before users pull out the USB device from the LP-8X81 Series, users need to type the “ **umount /mnt/usb** ” command first. Then pull out the USB device to prevent any damage to usb device.

## 4.4 System Language

The LP-8X81 Series system default language is English, If you want to change to other languages, you can use below method:

- (1) Type command “**vi /etc/sysconfig/i18n**”
- (2) Change line “LANG”, to language what you wants to use. (Please refer Fig 4-14), if you want to use Simplified Chinese, and format is UTF-8, you can change “**en\_US**” to “**zh\_CN.UTF-8**”.

A terminal window showing a text editor interface. The first line is "LANG=" en\_US" and the second line is "SYSFONT="lat0-sun16". The first line is highlighted with a red box. There are blue arrows pointing to the right on the lines below.

Fig 4-14

- (3) Type “**:wq**” to quit and save the file.
- (4) Type “**source /etc/sysconfig/i18n**” to enable language setting.
- (5) Type command “**locale**” to see which language you use now.

## 4.5 VGA Resolution

There are two modes -- **800x600** 、 **1024x768(default VGA Resolution)** supported in the LinPAC VGA resolution and the default setting is 1024x768. If users want to change the VGA resolution. Please follow below steps:

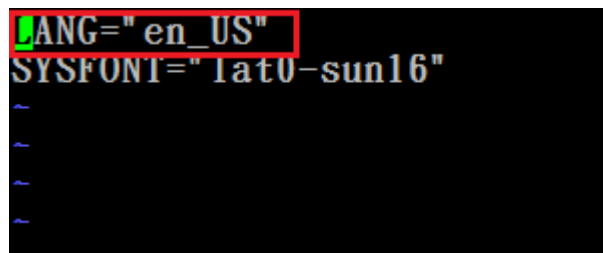
- (1) Type user ID and password login to desktop.

(2) Choose menu bar **“Desktop”**→**“Preferences”**→**“Screen Resolution”**. (For LP-8X81-Atom)

Choose menu bar **“System”**→**“Preferences”**→**“Display”**. (For LP-8X81)

(3) Use “Screen Resolution Preferences” to adjust VGA Resolution (Please refer to Fig 4-15)

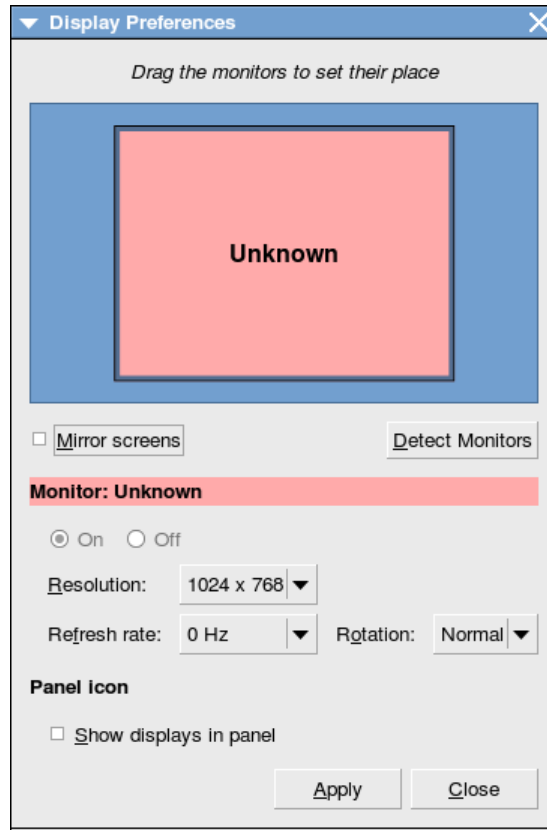

Fig 4-15



## 4.6 Make a new CF card to recover LP-8x81 Series OS

This section is help you make a new CF card when your CF card is lost or corrupt.

You can refer below steps to make a new CF card and recover LP-8x81 series OS. Please notice that you should backup your data first, because this action will clear all data with CF card and flash.

The LP-8x81 series CF card device name is /dev/hdb1, and LP-8x81-Atom series CF card device name is /dev/sdb1, **we will use LP-8x81 device and device name (/dev/hdb1) for sample in this section.**

1. Put CF card to CF card slot and boot on LP-8X81.

2. Download CF OS file.

(1)If your device is LP-8x81-Atom series device, type below command to download file

```
#wget http://ftp.icpdas.com/pub/cd/linpac/napdos/lp-8x8x/atom/cf\_card/linpac-8x81-atom-cf\_rootfs.tar.gz
```

(1)If your device is LP-8x81 series device, type below command to download file

```
#wget http://ftp.icpdas.com/pub/cd/linpac/napdos/lp-8x8x/lx800/cf_card/linpac-8x81-cf_rootfs.tar.gz
```

3. Install the file you download to the CF card.

(1) Type command “fdisk -l” to make sure “/dev/hdb1” device file is exist.

(2) Type command “mke2fs -jv /dev/hdb1” to format CF card.

(3) Type command “mount /dev/hdb1 /mnt”, mount /dev/hdb1 (CF card) to /mnt.

(4) Type command “tar zxvf **linpac-8x81-cf\_rootfs.tar.gz** -C /mnt”, decompression “**linpac-8x81-cf\_rootfs.tar.gz**” file to /mnt (CF card). (If you use LP-8x81-Atom device, the file name is “**linpac-8x81-atom-cf\_rootfs.tar.gz**”)

(5) Install CF card bootloader, please follow below steps.

[1] Type command “grub” to get in grub menu.

[2] Type command “root (hd1,0)”.

[3] Type command “setup (hd1)”.

[4] Type command “setup (hd1,0)”.

[5] Type command “quit”

(6) Reboot.

#### 4. Adjust your boot priority.

##### LP-8x81 series device

- (1) Type delete button to get in BIOS menu.
- (2) Enter "Advanced BIOS Features"
- (3) Set "First Boot Device" to "HDD-1"

##### LP-8x81-Atom series device

- (1) Type delete button to get in BIOS menu.
- (2) Enter "Boot"
- (3) Enter "Hard Disk Drives"
- (4) Set "1st Drive" to "SATA:PS-CF Card"

#### 5. Recover OS by CF card (This step will clean data up, please back up your data).

- (1) Type command "setup-control", recover OS.

#### 6. Adjust your boot priority.

##### LP-8x81 series device

- (1) Type delete button to get in BIOS menu.
- (2) Enter "Advanced BIOS Features"
- (3) Set "First Boot Device" to "HDD-0"

##### LP-8x81-Atom series device

- (1) Type delete button to get in BIOS menu.
- (2) Enter "Boot"
- (3) Enter "Hard Disk Drives"
- (4) Set "1st Drive" to "SATA:PS-8GB ATA Flash Disk"

#### 7. Type command "uname -r" to check kernel version, new OS kernel version is 2.6.33

## 4.7 Running applications automatically at boot time

A "run level" determines which programs are executed at system startup. Run level 5 is the default run level of LP-8X81 Series. The contents of run level are in the "/etc/init.d" directory that directory contains the scripts executed at boot time. These scripts are referenced by symbolic links in the /etc/rc5.d. These links are named

S<2-digit-number><original-name>. The numbers determine the order in which the scripts are run, from 00 to 99 — the lower number would earlier executed. Scripts named with an **S** are called with start, and named with a **K** or **x** are called with stop.

## 4.8 Set up OS filesystem check (fsck) at boot time

When your PAC abnormal reboot or reboot lots of times, OS may force you check filesystem at boot time by system utility “fsck” manually like fig 4-16. If your PAC is remote control, you should near to PAC to handle this question.

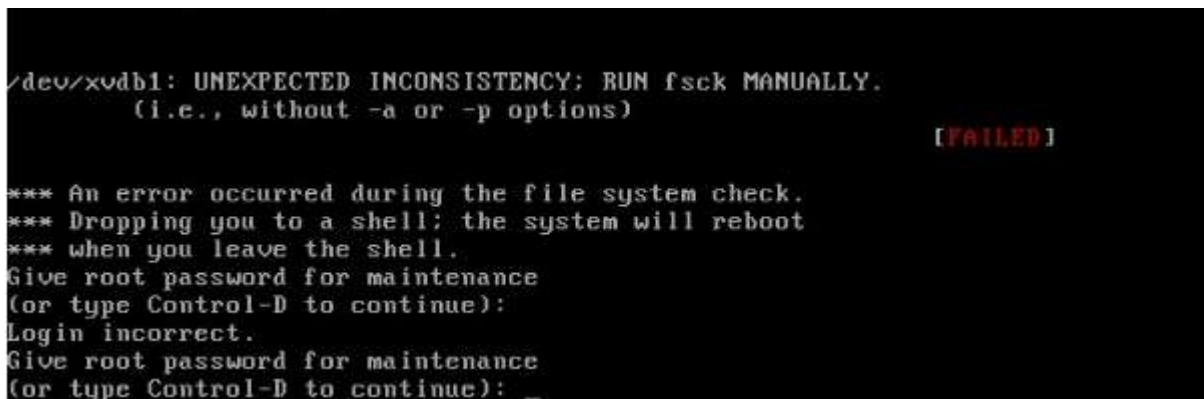
A terminal window showing an fsck error. The text reads: "/dev/xvdb1: UNEXPECTED INCONSISTENCY; RUN fsck MANUALLY. (i.e., without -a or -p options) [FAILED] \*\*\* An error occurred during the file system check. \*\*\* Dropping you to a shell; the system will reboot \*\*\* when you leave the shell. Give root password for maintenance (or type Control-D to continue): Login incorrect. Give root password for maintenance (or type Control-D to continue): \_".

```
/dev/xvdb1: UNEXPECTED INCONSISTENCY; RUN fsck MANUALLY.
(i.e., without -a or -p options) [FAILED]

*** An error occurred during the file system check.
*** Dropping you to a shell; the system will reboot
*** when you leave the shell.
Give root password for maintenance
(or type Control-D to continue):
Login incorrect.
Give root password for maintenance
(or type Control-D to continue): _
```

Fig 4-16

You can use below two method to avoid this question.

1. Disable “fsck” at boot time.

```
#vim /etc/fstab
```

Modify the /dev/sda1 (or /dev/hda1) end of line, default setting is 1, changed to 0 to disable “fsck” at boot time.

```

#
# /etc/fstab
# Created by anaconda on Tue Jan  1 08:45:53 2002
#
# Accessible filesystems, by reference, are maintained under '/dev/disk'
# See man pages fstab(5), findfs(8), mount(8) and/or blkid(8) for more info
#
/dev/sda1          /                    ext3    defaults    1 1
#tmpfs             /dev/shm             tmpfs   defaults    0 0
devpts            /dev/pts             devpts  gid=5,mode=620 0 0
sysfs             /sys                 sysfs   defaults    0 0
proc              /proc                proc    defaults    0 0
~

```

2. Force “fsck” at every boot time.

This method will gain boot time.

```
#echo > /forcefsck //Create a file named forcefsck
```

```
#chattr +l /forcefsck //Let file “forcefsck” alive
```

---

## 5. Instructions for the LP-8X81 Series

---

In this section, some Linux instructions that are often used will be introduced. The use of these instructions in Linux is very familiar with those in DOS and generally they are used in lower case.

### 5.1 Basic Linux Instructions

#### 5.1.1 Linux Command “ls”

**ls** : list the file information —> ( like dir in DOS )

Parameter :

(1) -l : list detailed information of file      ( Example : ls -l )

- (2) -a : list all files including hidden files ( Example : ls -a )
- (3) -t : list the files that are arranged by time(from new to old)

### 5.1.2 Linux Command “cd”

**cd directory : Change directory —> ( like cd in DOS )**

Parameter :

- (1) .. : move to the upper directory ( Example : cd .. )
- (2) ~ : move back to the root directory ( Example : cd ~ )
- (3) / : divided sign (for examples : cd /root/i8k )

### 5.1.3 Linux Command “mkdir”

**mkdir : create the subdirectory —> ( like md in DOS )**

mkdir -parameter subdirectory ( Example : mkdir owner )

### 5.1.4 Linux Command “rmdir”

**rmdir : delete(remove) the subdirectory and it must be empty —>**

**( like rd in DOS )**

mkdir -parameter subdirectory( Example : rmdir owner )

### 5.1.5 Linux Command “rm”

**rm : delete file or directory —> ( like del or deltree in DOS )**

rm -parameter file ( or directory )

Parameter :

- (1) i : it will show the warning message when deleting ( Example : rm -i test.exe )
- (2) r : delete directory despite that it isn't empty ( Example : rm -r Test )
- (3) f : it will not show a warning message when deleting ( Example : rm -f test.exe )

### 5.1.6 Linux Command “cp”

**cp : copy file —> ( like copy in DOS )**

cp -parameter source destination( Example : cp test.exe /root/Test/test.exe )

### 5.1.7 Linux Command “mv”

**mv : move or rename file or directory —> ( like move or ren in DOS )**

mv -parameter source file ( or directory ) destination file ( or directory )

( Example : mv test.exe test1.exe )

( Example : mv test.exe /root/Test )

### 5.1.8 Linux Command “pwd”

**pwd : show the current path**

### 5.1.9 Linux Command “who”

**who : show the on-line users**

### 5.1.10 Linux Command “chmod”

**chmod : change authority of file**

chmod ??? file —> ??? means owner : group : all users

For example :

chmod 754 test.exe

7 5 4 —> 111(read, write, execute) 101(read, write, execute) 100(read, write, execute)

The first number 7 : **owner** can read and write and execute files

The second number 5 : **group** can only read and execute files

The third number 4 : **all users** can only read files

### 5.1.11 Linux Command “uname”

**uname** : show the version of linux

### 5.1.12 Linux Command “ps”

**ps** : show the procedures that execute now

### 5.1.15 Linux Command “date”

**date** : show date and time

### 5.1.16 Linux Command “netstat”

**netstat** : show the state of network

Parameter [ -a ] : list all states ( Example : netstat -a )

### 5.1.17 Linux Command “ifconfig”

**ifconfig** : show the ip and network mask ( like ipconfig in DOS )

### 5.1.18 Linux Command “wget”

**wget** : get the file from the web link.

### 5.1.19 Linux Command “ping”

**ping** : check to see if the host in the network is alive

ping IPAddress ( Example : ping 192.168.0.1 )

### 5.1.19 Linux Command “clear”

**clear** : clear the screen

## 5.1.20 Linux Command “passwd”

**passwd** : change the password

## 5.1.21 Linux Command “reboot”

**reboot** : reboot the LinPAC

## 5.2 A Simple Example – Helloworld.c

In this section, we will introduce how to compile the helloworld.c to helloworld and transfer the helloworld to the LP-8X81 Series by using WinSCP software or “scp” command (please refer to the Fig 5-1). Finally executes this file on the LP-8X81 Series. In this example, no ICP DAS modules are used.

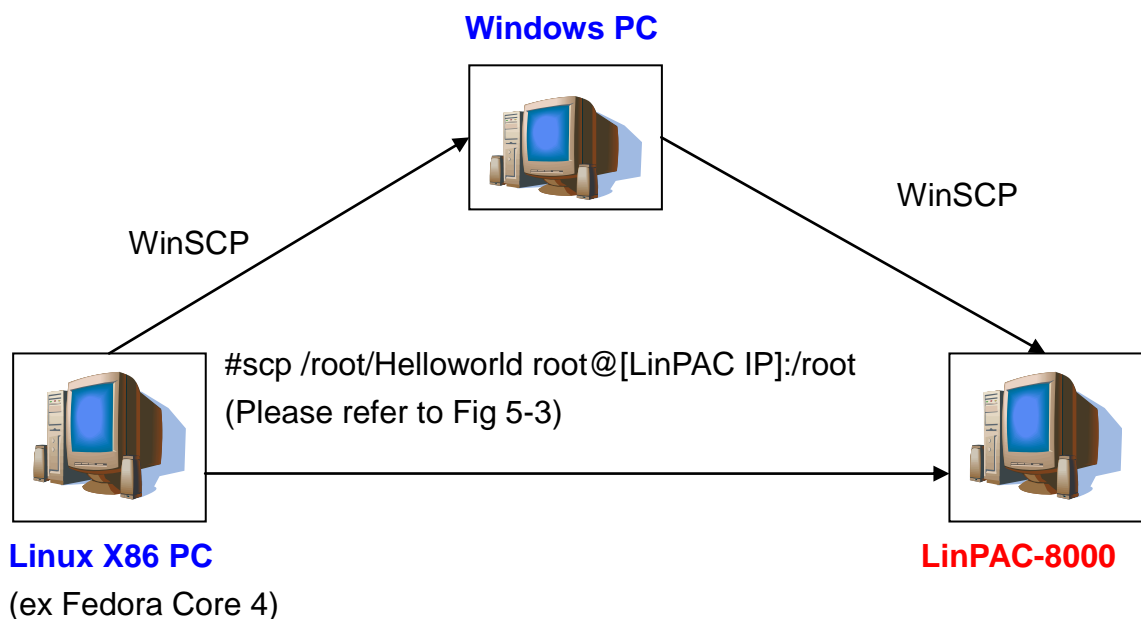

Fig 5-1



If you want to use the modules of ICP DAS to control your system, you can refer to demo in the chapter 7. These processes can be divided into three steps and they are given as below :

### STEP 1 : ( Compile helloworld.c to helloworld on the Linux X86 PC)

- (1) Create Helloworld.c on the linux PC(using linux distribution, for example Fedora Core 4, please refer to the Fig 5-2):
- (2) Type in “**gcc –o Helloworld Helloworld.c**“ to compile Helloworld.c into helloworld (please refer to Fig 5-2)

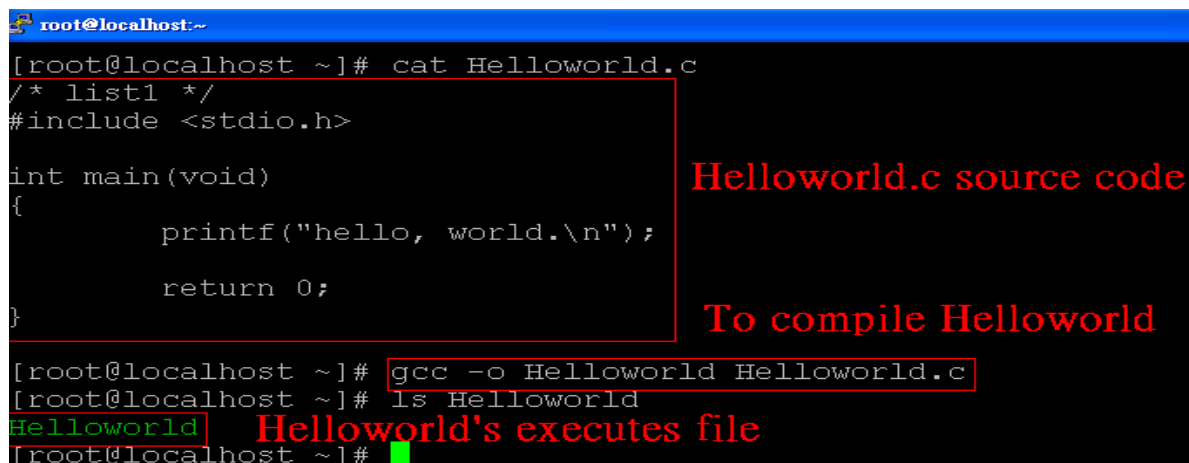

```
root@localhost:~# cat Helloworld.c
/* list1 */
#include <stdio.h>

int main(void)
{
    printf("hello, world.\n");
    return 0;
}

root@localhost ~]# gcc -o Helloworld Helloworld.c
root@localhost ~]# ls Helloworld
Helloworld
```

**Helloworld.c source code**

**To compile Helloworld**

**Helloworld's executes file**

Fig 5-2

### STEP 2 : ( Transfer Helloworld to the LP-8X81-Atom )

There are two methods for transferring files to the LP-8X81-Atom :

< **Method one** > **By Using the “Linux Command Prompt” :**

Open a “Linux Command Prompt” and type “`scp /root/Helloworld root@[LinPAC-8000 IP] /root`” command to connect and transmit the executes “Helloworld” to the LP-8X81 Series. Then type the Password ( “icpdas” is the default value. ) to accomplish the connection and transmission from the linux PC to the LP-8X81 Series.Please refer to Fig 5-3.

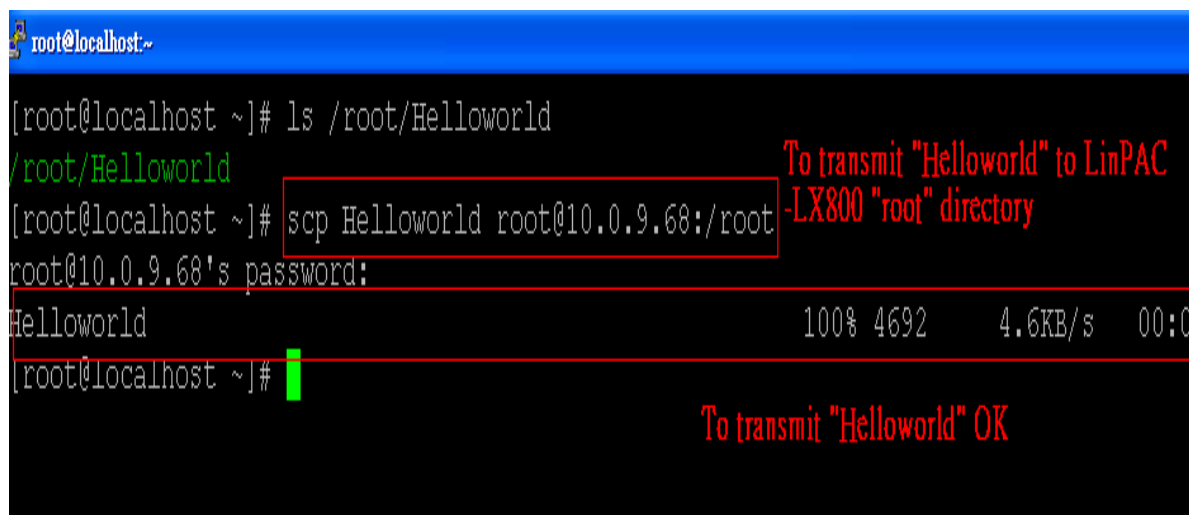

```
root@localhost:~# ls /root/Helloworld
/root/Helloworld
root@localhost ~]# scp Helloworld root@10.0.9.68:/root
root@10.0.9.68's password:
Helloworld 100% 4692 4.6KB/s 00:00
root@localhost ~]#
```

**To transmit "Helloworld" to LinPAC-LX800 "root" directory**

**To transmit "Helloworld" OK**

Fig 5-3

< Method two > By Using WinSCP Software :

- (1) Open the WinSCP Software and type the user and password, ssh port and the IP of linux PC. After user set the configure, user can click “login” button to connect to the Linux PC (please refer to Fig 5-4)



Fig 5-4

- (2) After user connect to the linux PC, user could find the “Helloworld” file in the directory that user compiled. Then user could drag the file “Helloworld” from the linux directory to window directory. (Refer to Fig.5-5).

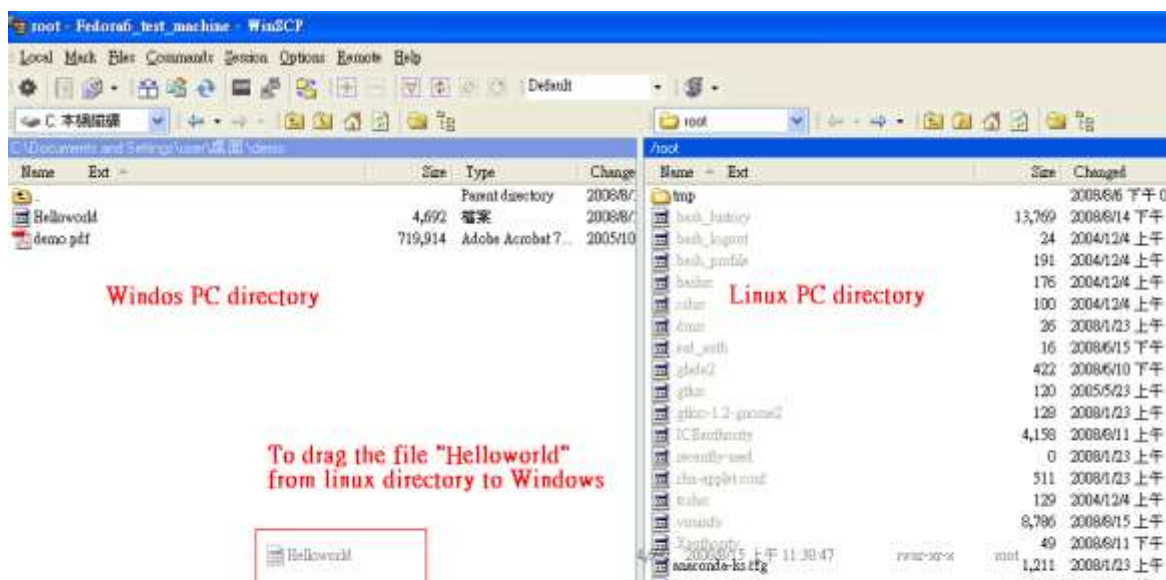

Fig.5-5

- (3) After user get the file "Helloworld" from the linux PC, user could upload the file to the LP-8X81 Series. Please create a new the login window of WinSCP, then type the LP-8X81 Series user and password, ssh port and the IP. After user set the configure, user can click "login" button to connect to the LP-8X81 Series (please refer to Fig 5-6).

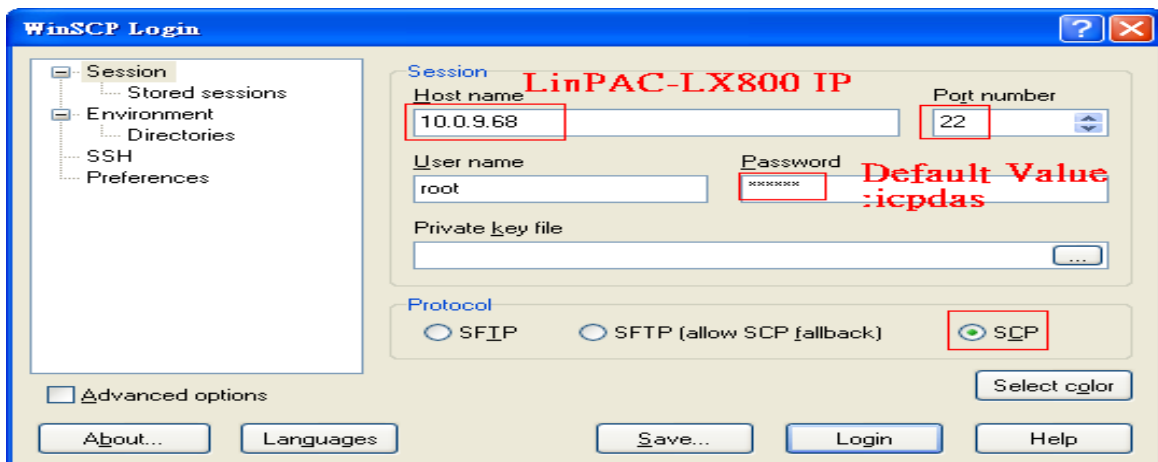

Fig 5-6

- (4) Upload the file - **Helloworld** to the LP-8X81 Series. (Refer to Fig.5-7).

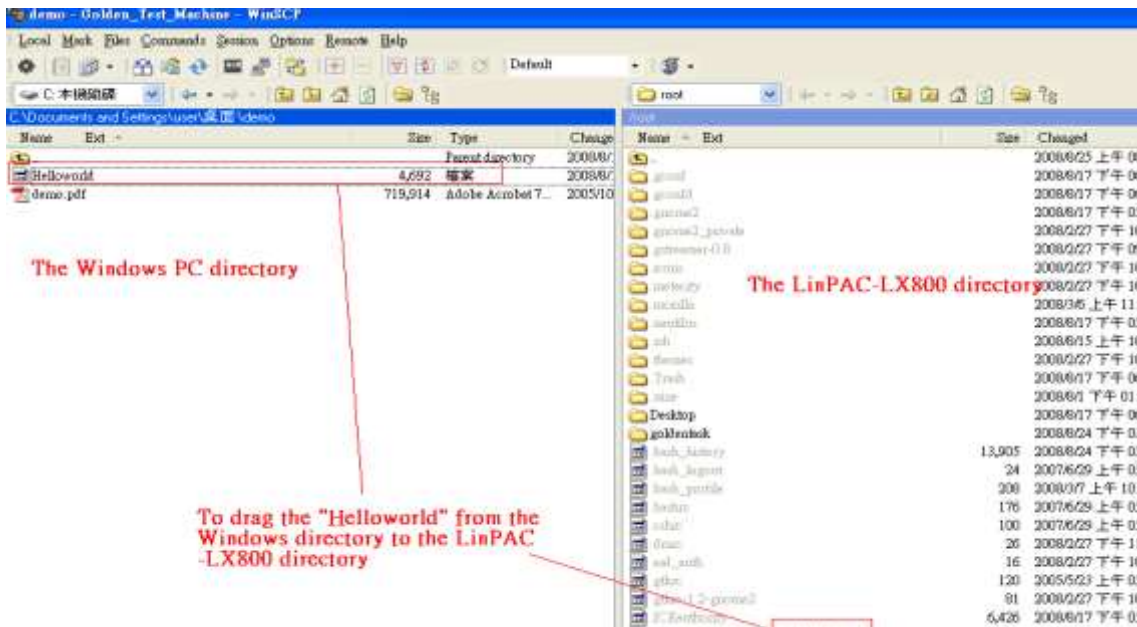
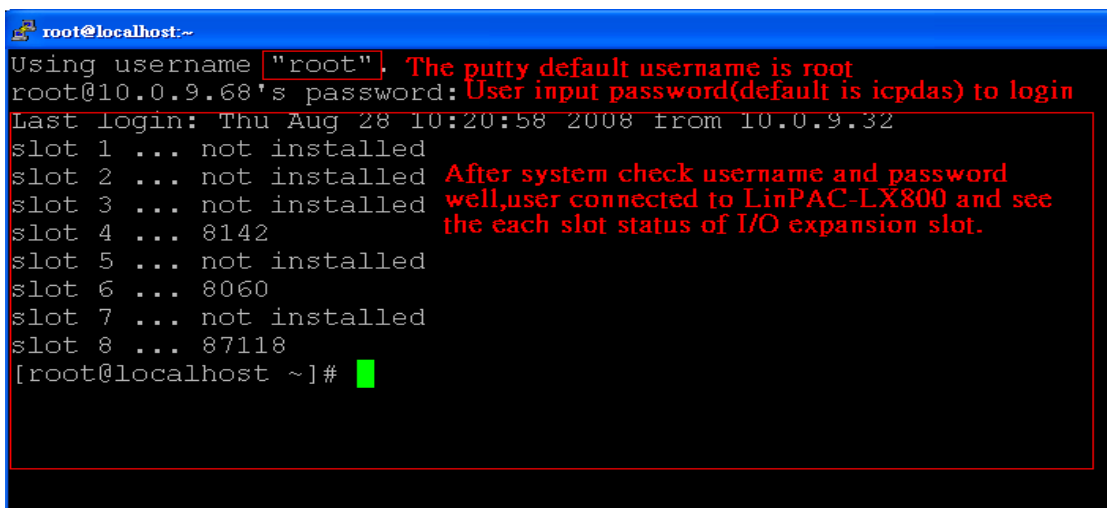

Fig.5-7

### STEP 3 : ( SSH to the LP-8X81 Series and execute program)

- (1) To use “putty.exe” software (please refer to chapter 4) or “telnet” command (please refer to chapter 4) to connect to the remote server of the LP-8X81 Series. Then type the **Password (“root” is the default value.)**. If it shows the “ # “ prompt character, the process of connecting from your PC to the remoter server of the LP-8X81 Series is finished. (refer to Fig.5-8)



```
root@localhost:~  
Using username "root". The putty default username is root  
root@10.0.9.68's password: User input password(default is icpdas) to login  
Last login: Thu Aug 28 10:20:58 2008 from 10.0.9.32  
slot 1 ... not installed  
slot 2 ... not installed  
slot 3 ... not installed  
slot 4 ... 8142  
slot 5 ... not installed  
slot 6 ... 8060  
slot 7 ... not installed  
slot 8 ... 87118  
[root@localhost ~]#
```

Fig.5-8

- (2) Type in the “ls” command in order to list all the files in /root and to see the “Helloworld” file. Then type in the “**chmod 777 Helloworld**” command to change the authority of Helloworld. This means that the file is executable. Type in “**./Helloworld**” to execute the file and it will show “hello, world.”. Then all the steps from **compile**、**transfer** to **connect to execute program** will be completed. (Refer to Fig.5-9)

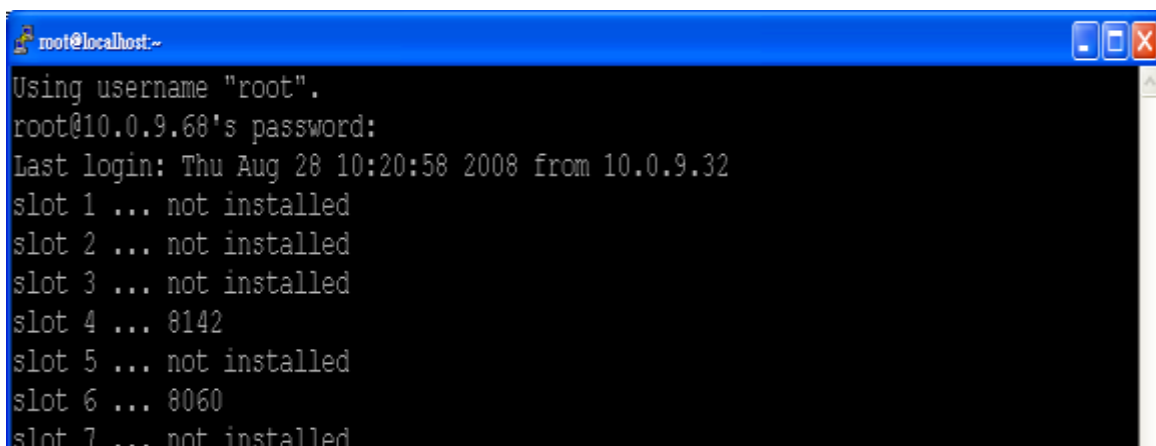

```
root@localhost:~  
Using username "root".  
root@10.0.9.68's password:  
Last login: Thu Aug 28 10:20:58 2008 from 10.0.9.32  
slot 1 ... not installed  
slot 2 ... not installed  
slot 3 ... not installed  
slot 4 ... 8142  
slot 5 ... not installed  
slot 6 ... 8060  
slot 7 ... not installed
```

Fig.5-9

## 5.3 i-Talk Utility

The **i-Talk utility** provides **sixteen instructions** that make it convenient for users to access the modules and hardware in the LP-8X81 Series and they are placed in the path - **/usr/bin**. Table 5-1 describes the functions of i-Talk utility.

<b>Instruction</b>	<b>Function Description</b>
getlist	List all module name in the LP-8X81 Series
setdo	Set digital output value to 8k module
setao	Set analog output value to 8k module
getdi	Get digital input value from 8k module
getai	Get analog input value from 8k module
setexdo	Set digital output value to 7k/87k module
setexao	Set analog output value to 7k/87k module

getexdi	Get digital input value from 7k/87k module
getexai	Get analog input value from 7k/87k module
setport	Set port value by offset to a module
getport	Get port value by offset from a module
setsend	Send string from LinPAC COM port
getreceive	Receive string from LinPAC COM port
getsendreceive	Send/Receive string from LinPAC COM port
read_sn	Get Hardware Serial Number of LP-8X81 Series
rotary_atom_id	Get Rotary Switch ID of LP-8X81-Atom

Table 5-1

Table 5-2 lists the demos that show how to use the I-talk utility. In the demo, the **I-8024** ( AO Module ) 、 **I-8017H** ( AI Module ) and **I-8055** ( DIO Module) are all used and they are plugged into the slots 1 、 2 and 3 of the LinPAC separately.

Instruction	Demo
getlist	<b>Command:</b> getlist → getlist <b>Description:</b> List all module names in the LP-8X81 Series.
setdo	<b>Command:</b> setdo [slot] [data] → setdo 3 3 <b>Description:</b> Set i-8055 channel 1 and 2 on.

setao	<p><b>Command:</b>  setao [slot] [channel] [data]  → setao 1 0 2.2</p> <p><b>Description:</b>  Set the i-8024 channel 0 output 2.2V.</p>
getdi	<p><b>Command:</b>  getdi [slot] [type]  → getdi 3 8</p> <p><b>Description:</b>  Get the 8 bits DI value from i-8055.</p>
getai	<p><b>Command:</b>  getai [slot] [channel] [gain] [mode]  → getai 2 0 0 0</p> <p><b>Description:</b>  Get the AI value from i-8017HW.</p>
setexdo	<p><b>Command:</b>  (1)setexdo [slot] 1 [data]  → setexdo 2 1 55  (2)setexdo [slot] [comport] [data] [baudrate] [address]  → setexdo 0 3 55 9600 2</p> <p><b>Description:</b>  (1)Set the dec digital output value to the module at slot 2 at COM1.  (2)Set the dec digital output value to the module at slot 0 at COM3.</p>
setexao	<p><b>Command:</b>  (1)setexao [slot] 1 [value] [channel]  → setexao 2 1 6.7 5  (2)setexao [slot] [comport] [value] [channel] [baudrate] [address]  → setexao 0 3 6.7 5 9600 2</p> <p><b>Description:</b>  (1)Set channel 5 analog value 6.7 to the module at slot</p>

	<p>2.  (2)Set channel 5 analog value 6.7 to the module at COM3.</p>
getexdi	<p><b>Command:</b>  (1)getexdi [slot] 1  → getexdi 2 1  (2)getexdi [slot] [comport] [baudrate] [address]  → getexdi 0 3 9600 2</p> <p><b>Description:</b>  (1)Get the dec digital input value from the module at slot 2.  (2)Get the dec digital input value from the module at COM3.</p>
getexai	<p><b>Command:</b>  (1)getexai [slot] 1 [channel]  → getexai 2 1 5  (2)getexai [slot] [comport] [channel] [baudrate] [address]  → getexai 0 3 5 9600 2</p> <p><b>Description:</b>  (1)Get channel 5 analog value from the module at slot 2.  (2)Get channel 5 analog value from the module at COM3.</p>
read_sn	<p><b>Command:</b>  read_sn  → read_sn</p> <p><b>Description:</b>  Show the serial number..</p>

Table 5-2

Users can also type in the instructions name and it will show the instructions usage.





---

# 6. LIBI8K.A

---

In this section, we will focus on examples for the description of and application of the functions found in the Libi8k.a. The Libi8k.a functions can be clarified into 3 groups which are listed in Fig. 6-1

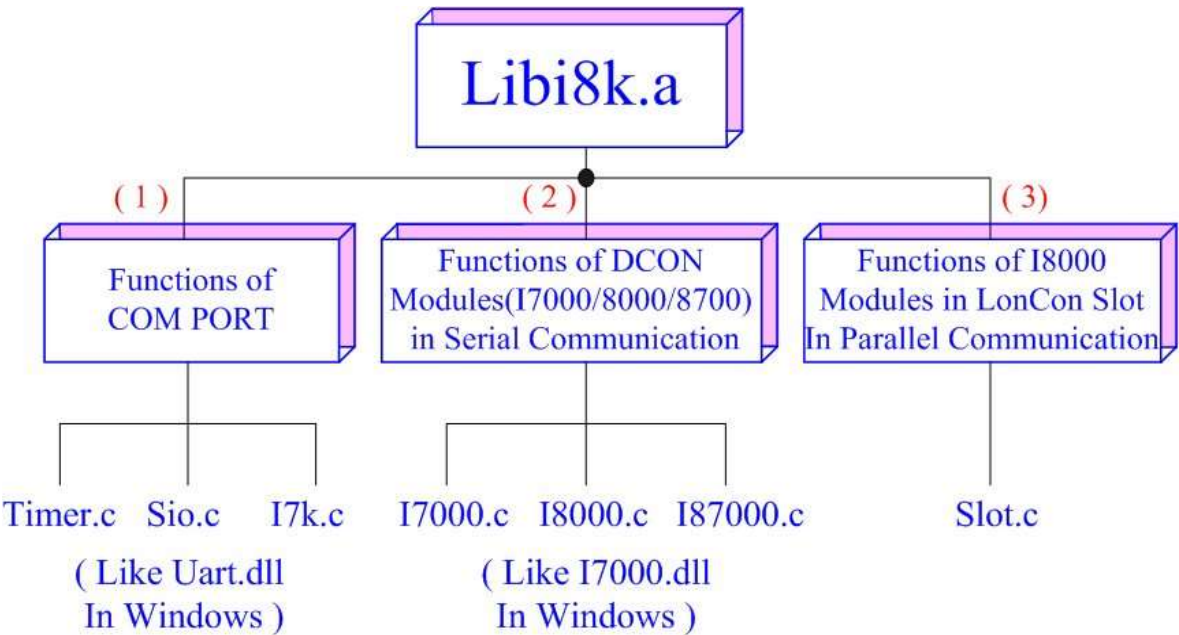

## Structure of Libi8k.a

Fig. 6-1

Functions (1) and (2) in the Libi8k.a are the same as with the DCON.DLL Driver (including Uart.dll and I7000.dll ) as used in the DCON modules ( I-7000 / I-8000 / I-87000 in serial communication ). You can refer to the DCON.DLL Driver manual which includes the functions on how to use DCON modules. The DCON.DLL Driver has already been wrapped into the Libi8k.a. Functions (3) of the Libi8k.a consist of the most important functions as they are especially designed for I-8000 modules in the LP-8X81 Series slots. They are different from functions (1) and (2) because the communication of I-8000 modules in the LP-8X81 Series slots are parallel and not

serial. Therefore ICP DAS rewrote I8000.c to “slot.c” especially for I-8000 modules in the LP-8X81 Series slots. Here we will introduce all the functions for “slot.c” and they can be divided into eight parts for ease of use.

1. System Information Functions;
2. Digital Input Functions;
3. Digital Output Functions;
4. Watch Dog Timer Functions;
5. EEPROM Read/Write Functions;
6. Analog Input Functions;
7. Analog Output Functions;

When using the development tools to develop applications, the “**msw.h**” file must be included in front of the source program, and when building applications, **Libi8k.a** must be linked. If you want to control ICP DAS I/O remote modules like i7k, i8k and i87k **through COM2 or COM3 or COM4 of the LinPAC**, the functions are all the same with DCON DLL. And if you want to control **i8k modules** that are plugged in the slots of the LinPAC, then the functions are different and they are described as below:

## 6.1 System Information Functions

### ChangeToSlot

#### Description:

This function is used to dedicate serial control to the specified slots for the control of the I-87k series. The serial bus in the LP-8X81 Series backplane is for mapping through to COM1. For example, if you want to send or receive data from a specified slot, you need to call this function first. Then you can use the other series functions.

#### Syntax:

```
[ C ]  
  
void ChangeToSlot(char slot)
```

#### Parameter:

slot : [Input] Specify the slot number in which the I/O module is plugged into.

## Return Value:

None

## Example:

```
char slot=1;
ChangeToSlot (slot);
// The first slot is specified as COM1 port in LP-8X81 Series.
```

## Open\_Slot

### Description:

This function is used to open and initiate a specified slot in the LP-8X81 Series. The 8k or I-87k modules in the LP-8X81 Series will use this function. For example, if you want to send or receive data from a specified slot, this function must be called first. Then the other functions can be used later.

### Syntax:

[ C ]
<code>int Open_Slot(int slot)</code>

### Parameter:

slot : [Input] Specify the slot number in which the I/O module is plugged into.

### Return Value:

0 is for Success  
Not 0 is for Failure

### Example:

```
Int slot=1;
Open_Slot(slot);
// The first slot in the LP-8X81 Series will be open and initiated.
```

### Remark:

## Close\_Slot

### Description:

If you have used the function of `Open_Slot()` to open the specified slot in the LP-8X81 Series, you need to use the `Close_Slot()` function to close the specified slot in the LP-8X81 Series. The 8k or I-87k modules in the LP-8X81 Series will use this function. For example, once you have finished sending or receiving data from a specified slot, this function would then need to be called.

### Syntax:

```
[ C ]  
  
void Close_Slot(int slot)
```

### Parameter:

slot : [Input] Specify the slot number in which the I/O module is plugged into.

### Return Value:

None

### Example:

```
Int slot=1;  
Close_Slot(slot);  
// The first slot in the LP-8X81 Series will be closed.
```

### Remark:

## Open\_SlotAll

### Description:

This function is used to open and initiate **all slots** in the LP-8X81 Series. For example, if you want to send or receive data from multiple slots, you can call this function to simplify your program. Then you can use the other functions later.

### Syntax:

[ C ]

`int` Open\_SlotAll(`void`)

**Parameter:**

None

**Return Value:**

0 is for Success

Not 0 is for Failure

**Example:**

```
Open_SlotAll();
```

```
// All slots in the LP-8X81 Series will be open and initiated.
```

**Remark:**

## Close\_SlotAll

**Description:**

If you have used the function Open\_SlotAll() to open all the slots in the LP-8X81 series, you can use the Close\_SlotAll() function to close all the slots in the LP-8X81 series. For example, once you are finish sending or receiving data from many slots, this function can be called to close all the slots rapidly.

**Syntax:**

[ C ]

`void` Close\_SlotAll(`void`)

**Parameter:**

None

**Return Value:**

None

**Example:**

```
Close_Slot();
```

// All slots in the LP-8X81 series will be closed.

**Remark:**

## GetModuleType

**Description:**

This function is used to retrieve which type of 8000 series I/O module is plugged into a specific I/O slot in the LP-8X81 Series. This function performs a supporting task in the collection of information related to the system's hardware configurations.

**Syntax:**

[ C ]
<code>int GetModuleType(char slot)</code>

**Parameter:**

slot : [Input] Specify the slot number in which the I/O module is plugged into.

**Return Value:**

Module Type: it is defined in the IdTable[] of slot.c.

**Example:**

```
char slot=1;
int moduleType;
Open_Slot(slot);
moduleType=GetModuleType(slot);
Close_Slot(slot);
// The I-8057 card is plugged in slot 1 of LP-8X81 Series and has a return Value : 20
```

**Remark:**

## GetNameOfModule

### Description:

This function is used to retrieve the name of an 8000 series I/O module, which is plugged into a specific I/O slot in the LP-8X81 Series. This function supports the collection of system hardware configurations.

### Syntax:

```
[ C ]  
  
int GetNameOfModule(char slot)
```

### Parameter:

slot : [Input] Specify the slot number where the I/O module is plugged into.

### Return Value:

I/O module ID. For Example, the I-8017 will return 8017.

### Example:

```
char slot=1;  
int moduleName;  
Open_Slot(slot);  
moduleID=GetNameOfModule(slot);  
Close_Slot(slot);  
// The I-8017 card plugged in slot 1 of LP-8X81 Series  
// Returned Value: moduleName=" 8017 "
```

### Remark:

## 6.2 Digital Input/Output Functions

### DO\_8

### Description:



This function is used to output 8-bit data to a digital output module. The 0~7 bits of output data are mapped into the 0~7 channels of digital module output respectively.

**Syntax:**

```
[ C ]  
void DO_8(int slot, unsigned char data)
```

**Parameter:**

slot : [Input] the slot number where the I/O module is plugged into.

data : [Input] output data.

**Return Value:**

None

**Example:**

```
int slot=1;  
unsigned char data=3;  
DO_8(slot, data);  
// The I-8064 card is plugged in slot 1 of LP-8X81 Series and can turn on channel 0  
// and 1.
```

**Remark:**

This function can be applied on modules: I-8060, I-8064, I-8065, I-8066, I-8068 and I-8069.

**DO\_16**

**Description:**

This function is used to output 16-bit data to a digital output module. The 0~15 bits of output data are mapped into the 0~15 channels of digital output modules respectively.

**Syntax:**

```
[ C ]
```

```
void DO_16(int slot, unsigned int data)
```

**Parameter:**

slot : [Input] the slot number where the I/O module is plugged into.

data : [Input] output data.

**Return Value:**

None

**Example:**

```
int slot=1;
```

```
unsigned int data=3;
```

```
DO_16(slot, data);
```

```
// The I-8057 card is plugged in slot 1 of LP-8X81 Series and can turn on channel 0
```

```
// and 1.
```

**Remark:**

This function can be applied on modules: I-8037, I-8056 and I-8057.

## DO\_32

**Description:**

Output the 32-bit data to a digital output module. The 0~31 bits of output data are mapped into the 0~31 channels of digital output modules respectively.

**Syntax:**

```
[ C ]  
void DO_32(int slot, unsigned int data)
```

**Parameter:**

slot : [Input] the slot number where the I/O module is plugged into.

data : [Input] output data.

**Return Value:**

None

**Example:**

```
int slot=1;
unsigned int data=3;
DO_32(slot, data);
// The I-8041 card is plugged in slot 1 of LP-8X81 Series and can turn on channel 0
// and 1.
```

**Remark:**

This function can be applied on module: I-8041.

## DI\_8

**Description:**

Obtains 8-bit input data from a digital input module. The 0~7 bits of input data correspond to the 0~7 channels of digital input modules respectively.

**Syntax:**

[ C ]
<code>unsigned char DI_8(int slot)</code>

**Parameter:**

slot : [Input] the slot number where the I/O module is plugged into.

**Return Value:**

Input data

**Example:**

```
int slot=1;
unsigned char data;
data=DI_8(slot);
// The I-8058 card is plugged in slot 1 of LP-8X81 Series and has inputs in
// channel 0 and 1.
// Returned value: data=0xfC
```

**Remark:**

This function can be applied on modules: I-8048, I-8052, I-8058.

## DI\_16

### Description:

This function is used to obtain 16-bit input data from a digital input module. The 0~15 bits of input data correspond to the 0~15 channels of digital module's input respectively.

### Syntax:

```
[ C ]  
  
unsigned int DI_16(int slot)
```

### Parameter:

slot : [Input] the slot number where the I/O module is plugged into.

### Return Value:

Input data

### Example:

```
int slot=1;  
unsigned int data;  
data=DI_16(slot);  
// The I-8053 card is plugged in slot 1 of LP-8X81 Series and has inputs in  
// channel 0 and 1.  
// Returned value: data=0xffC
```

### Remark:

This function can be applied on modules: I-8051, I-8053.

## DI\_32

### Description:

This function is used to obtain 32-bit input data from a digital input module. The 0~31 bits of input data correspond to the 0~31 channels of digital input module

respectively.

### Syntax:

```
[ C ]  
unsigned long DI_32(int slot)
```

### Parameter:

slot : [Input] the slot number where the I/O module is plugged into.

### Return Value:

Input data

### Example:

```
int slot=1;  
unsigned long data;  
data=DI_32(slot);  
// The I-8040 card plugged is in slot 1 of LP-8X81 Series and has inputs in  
// channels 0 and 1.  
// Returned value: data=0xfffffC
```

### Remark:

This function can be applied on module: I-8040.

## DIO\_DO\_8

### Description:

This function is used to output 8-bit data to DIO modules. These modules run 8 digital input channels and 8 digital output channels simultaneously. The 0~7 bits of output data are mapped onto the 0~7 output channels for their specific DIO modules respectively.

### Syntax:

```
[ C ]  
void DIO_DO_8(int slot, unsigned char data)
```

**Parameter:**

slot : [Input] the slot number where the I/O module is plugged into.

data : [Input] output data.

**Return Value:**

None

**Example:**

```
int slot=1;
```

```
unsigned char data=3;
```

```
DIO_DO_8(slot, data);
```

```
// The I-8054 card is plugged in slot 1 of LP-8X81 Series and can turn on channels 0
```

```
// and 1.
```

```
// It not only outputs a value, but also shows 16LEDs.
```

**Remark:**

This function can be applied in modules: I-8054, I-8055, and I-8063.

## DIO\_DO\_16

**Description:**

This function is used to output 16-bits of data to DIO modules, which have 16 digital input and 16 digital output channels running simultaneously. The 0~15 bits of output data are mapped onto the 0~15 output channels for their specific DIO modules respectively.

**Syntax:**

```
[ C ]  
  
void DIO_DO_16(int slot, unsigned int data)
```

**Parameter:**

slot : [Input] the slot number where the I/O module is plugged into.

data : [Input] output data.

## Return Value:

None

## Example:

```
int slot=1;
unsigned int data=3;
DIO_DO_16(slot, data);
// The I-8042 card is plugged in slot 1 of LP-8X81 Series and can turn on the
// channels 0 and 1.
// It not only outputs a value, but also shows 32LEDs.
```

## Remark:

This function can be applied on modules: I-8042 and I-8050

## DIO\_DI\_8

### Description:

This function is used to obtain 8-bit data from DIO modules. These modules run 8 digital input and 8 digital output channels simultaneously. The 0~7 bits of input data, are mapped onto the 0~7 input channels for their specific DIO modules respectively.

### Syntax:

[ C ]
<code>Unsigned char DIO_DI_8(int slot)</code>

### Parameter:

slot : [Input] the slot number where the I/O module is plugged into.

### Return Value:

Input data

### Example:

```
int slot=1;
unsigned char data;
data=DIO_DI_8(slot);
```

```
// The I-8054 card is plugged in slot 1 of LP-8X81 Series and has inputs in
// channel 0 and 1.
// Returned value: data=0xfC
```

**Remark:**

This function can be applied in modules: I-8054, I-8055 and I-8063.

## DIO\_DI\_16

**Description:**

This function is used to obtain 16-bit data from DIO modules. These modules run 16 digital input and 16 digital output channels simultaneously. The 0~15 bits of input data are mapped onto the 0~15 input channels for their specific DIO modules respectively.

**Syntax:**

[ C ]
Unsigned char DIO_DI_16(int slot)

**Parameter:**

slot : [Input] the slot number where the I/O module is plugged into.

**Return Value:**

Input data

**Example:**

```
int slot=1;
unsigned char data;
data=DIO_DI_16(slot);
// The I-8042 card is plugged in slot 1 of LP-8X81 Series and has inputs in
// channel 0 and 1.
// Returned value: data=0xffC
```

**Remark:**

This function can be applied in modules: I-8042.



**DO\_8\_RB**、**DO\_16\_RB**、**DO\_32\_RB**

**DIO\_DO\_8\_RB**、**DIO\_DO\_16\_RB**

### **Description:**

This function is used to **Readback** all channel status from a Digital Output module.

### **Syntax:**

```
[ C ]  
  
unsigned char DO_8_RB(int slot)  
unsigned int DO_16_RB(int slot)  
unsigned long DO_32_RB(int slot)  
unsigned char DIO_DO_8_RB(int slot)  
unsigned int DIO_DO_16_RB(int slot)
```

### **Parameter:**

slot : [Input] the slot number where the I/O module is plugged into.

### **Return Value:**

all DO channel status

### **Example:**

```
int slot=1;  
Open_Slot(slot);  
printf("%u",DO_32_RB(slot));  
Close_Slot(slot);  
  
// The I-8041 module is plugged in slot 1 of LP-8X81 Series and return all DO channel  
status. (Return value : From 0 ~ 4294967295 for 32 channel)
```

### **Remark:**

These functions can be applied on modules:

DO 8 channel : I-8060, I-i8064, I-8065, I-8066, I-8068 and I-8069.

DO 16 channel : I-8037, I-8056 and I-8057

DO 32 channel : I-8041

**DO\_8\_BW 、 DO\_16\_BW 、 DO\_32\_BW**

**DIO\_DO\_8\_BW 、 DIO\_DO\_16\_BW**

### **Description:**

This function is used to output **assigned single channel** status (ON / OFF) of a Digital Output module.

### **Syntax:**

```
[ C ]  
  
void DO_8_BW(int slot, int bit, int data)  
void DO_16_BW (int slot, int bit, int data)  
void DO_32_BW (int slot, int bit, int data)  
void DIO_DO_8_BW (int slot, int bit, int data)  
void DIO_DO_16_BW (int slot, int bit, int data)
```

### **Parameter:**

slot : [Input] the slot number where the I/O module is plugged into.

bit : [Input] channel of module.

data : [Input] channel status [ on(1) / off(0) ].

### **Return Value:**

None

### **Example:**

```
int slot=1, bit=0, data=1;
```

```
Open_Slot(slot);
```

```
DO_32_BW(slot, bit, data);
```

```
Close_Slot(slot);
```

```
// The I-8041 module is plugged in slot 1 of LP-8X81 Series and just turn on channel 0  
of I-8041.
```

### **Remark:**

These functions can be applied on modules:

DO 8 channel : I-8060, I-8064, I-8065, I-8066, I-8068 and I-8069.

DO 16 channel : I-8037, I-8056 and I-8057

DO 32 channel : I-8041

## DI\_8\_BW 、 DI\_16\_BW 、 DI\_32\_BW

### Description:

This function is used to **Readback assigned single channel** status (ON / OFF) from a Digital Input module.

### Syntax:

```
[ C ]  
  
int DI_8_BW(int slot, int bit)  
int DI_16_BW (int slot, int bit)  
int DI_32_BW (int slot, int bit)
```

### Parameter:

slot : [Input] the slot number where the I/O module is plugged into.

bit : [Input] channel of module.

### Return Value:

None

### Example:

```
int slot=1, bit=0;
```

```
Open_Slot(slot);
```

```
printf("DI channel %d = %d\n", bit, DI_32_BW(slot, bit));
```

```
Close_Slot(slot);
```

```
// The I-8040 module is plugged in slot 1 of LP-8X81 Series and return channel 0
```

```
// status. ( 0 : ON ; 1 : OFF ).
```

### Remark:

These functions can be applied on modules:

DI 8 channel : I-8048, I-8052 and I-8058.

DI 16 channel : I-8051 and I-8053

DI 32 channel : I-8040

## UDIO\_WriteConfig\_16

### Description:

This function is used to configure the channel of the universal DIO module which is digital input or digital output mode. The universal DIO module can be up to 16 digital input or digital output channels running simultaneously.

### Syntax:

```
[ C ]  
unsigned short UDIO_WriteConfig_16(int slot, unsigned short config)
```

### Parameter:

slot : [Input] the slot number where the I/O module is plugged into.

config : [Input] channel status.[ DO : 1 / DI : 0 ]

### Return Value:

None

### Example:

```
int slot=1;  
unsigned short config=0xffff;  
UDIO_WriteConfig_16(slot, config);  
// The I-8064 card is plugged in slot 1 of LP-8X81 Series.  
// WriteConfig: 0xffff (ch 0~ch15 is DO mode)
```

### Remark:

This function can be applied on modules: I-8050.

## UDIO\_ReadConfig\_16

### Description:

This function is used to read the channels configuration of the universal DIO module which is digital input or digital output mode.

**Syntax:**

```
[ C ]  
  
unsigned short UDIO_ReadConfig_16(int slot)
```

**Parameter:**

slot : [Input] the slot number where the I/O module is plugged into.

**Return Value:**

None

**Example:**

```
int slot=1;  
unsigned int ret;  
unsigned short config=0x0000;  
UDIO_WriteConfig_16(slot, config);  
ret=UDIO_ReadConfig_16(slot);  
printf("Read the I/O Type is : 0x%04lx \n\r",ret);  
// The I-8050 card is plugged in slot 1 of LP-8X81 Series.  
// WriteConfig: 0x0000 (ch 0~ch15 is DI mode)  
// Read the I/O Type is: 0x0000
```

**Remark:**

This function can be applied on modules: I-8050.

**UDIO\_DO16****Description:**

This function is used to output 0~15 bits data to a universal DIO module according to the channel configuration. The 0~15 bits of output data are mapped onto the 0~15 output channels for their specific universal DIO modules respectively.

**Syntax:**

[ C ]

```
void UDIO_DO16(int slot, unsigned short config)
```

### Parameter:

slot : [Input] the slot number where the I/O module is plugged into.

config : [Input] output data.

### Return Value:

None

### Example:

```
int slot=1;
unsigned int data;
unsigned short config =0x00ff;
UDIO_WriteConfig_16(slot, config);
scanf("%d",&data);
UDIO_DO16(slot, data);
printf("DO(Ch0~Ch7) of I-8050 in Slot %d = 0x%x\n\r",slot, data);
// The I-8050 card is plugged in slot 1 of LP-8X81 Series
// WriteConfig: 0x00ff (ch 0~ch7 is DO mode and ch8~ch15 is DI mode)
// Input DO value: 255
// DO(Ch0~Ch7) of I-8050 in Slot 1 = 0xff
```

### Remark:

This function can be applied on modules: I-8050.

## UDIO\_DI16

### Description:

This function is used to input 0~15 bits data to a universal DIO module according to the channel configuration. The 0~15 bits of input data are mapped onto the 0~15 input channels for their specific universal DIO modules respectively.

### Syntax:

[ C ]

```
unsigned short UDIO_DI16(int slot)
```

**Parameter:**

slot : [Input] the slot number where the I/O module is plugged into.

**Return Value:**

None

**Example:**

```
int slot=1;
unsigned int data;
unsigned short config =0xff00;
UDIO_WriteConfig_16(slot, config);
data=UDIO_DI16(slot);
printf("DI(Ch0~Ch7) of I-8055 in Slot %d = 0x%x\n\r",slot, data);
scanf("%d:",&data);
UDIO_DO16(slot, data);
printf("DO(Ch8~Ch15) of I-8050 in Slot %d = 0x%x\n\r",slot, data);
// The I-8050 card is plugged in slot 1 of LP-8X81 Series.
// WriteConfig: 0x00ff (ch 0~ch7 is DI mode and ch8~ch15 is DO mode)
// DI(Ch0~Ch7) of I-8055 in Slot 1 = 0xfbff
// Input DO value: 255
// DO(Ch8~Ch15) of I-8050 in Slot 1 = 0xff
```

**Remark:**

This function can be applied on modules: I-8050.

## 6.3 Watch Dog Timer Functions

### EnableWDT

**Description:**

This function can be used to enable the watch dog timer (WDT) and users need

to reset WDT in the assigned time set by users. Or LinPAC will reset automatically.

### Syntax:

```
[C]  
void EnableWDT(unsigned int msecond)
```

### Parameter:

msecond:LinPAC will reset in the assigned time if users don't reset WDT.

The unit is mini-second.

### Return Value:

None

### Example:

```
EnableWDT(10000); //Enable WDT interval 10000ms=10s  
while (getchar()=='10')  
{  
    printf("Refresh WDT\n");  
    EnableWDT(10000); //Refresh WDT 10s  
}  
printf("Disable WDT\n");  
DisableWDT();
```

### Remark:

## DisableWDT

### Description:

This function is used to disable WDT.

### Syntax:

```
[C]  
void DisableWDT(void)
```



**Parameter:**

None

**Return Value:**

None

**Example:****Remark:**

## WatchDogSWEven

**Description:**

This function is used to read the LinPAC Reset Condition and users can reinstall the initial value according to the Reset Condition.

**Syntax:**

```
[C]  
  
unsigned int WatchDogSWEven (void)
```

**Parameter:**

None

**Return Value:**

Just see the last number of the return value – **RCSR** ( Reset Controller Status Register). For example: RCSR is “20009a4”, so just see the last number “4”. 4 is **0100** in bits and it means:

**Bit 0:** [Hardware Reset](#) (Like: Power Off, Reset Button)

**Bit 1:** [Software Reset](#) (Like: Type “Reboot” in command prompt)

**Bit 2:** [WDT Reset](#) (Like: Use “EnableWDT(1000)”)

**Bit 3:** [Sleep Mode Reset](#) (Not supported in the LinPAC)

**Example:**

```
printf("RCSR = %x\n", WatchDogSWEven() );
```

**Remark:**

## ClearWDTSEven

**Description:**

This function is used to clear RCSR value.

**Syntax:**

[C]
<code>void ClearWDTSEven (unsigned int rcsr)</code>

**Parameter:**

rcsr : Clear bits of RCSR. Refer to the following parameter setting :

- 1 : clear bit 0
- 2 : clear bit 1
- 4 : clear bit 2
- 8 : clear bit 3
- F : clear bit 0 ~ bit 3

**Return Value:**

None

**Example:**

```
ClearWDTSEven(0xF) ; //Used to clear bit 0 ~ bit 3 of RCSR to be zero.
```

**Remark:**

## 6.4 EEPROM Read/Write Functions

### Enable\_EEP

**Description:**

This function is used to make EEPROM able to read or write. It must be used

before using Read\_EEP or Write\_EEP. This EEPROM is divided into 256 blocks (0 to 255), and each block is 64 bytes in length from offset 0 to 63.

### Syntax:

[ C ]
<code>void Enable_EEP(void)</code>

### Parameter:

None

### Return Value:

None

### Example:

```
Enable_EEP();
```

```
// After using this function, you can use Write_EEP or Read_EEP to write or read  
// data of EEPROM.
```

### Remark:

## Disable\_EEP

### Description:

This function is used to make EEPROM unable to read or write. You need to use this function after using Read\_EEP or Write\_EEP. Then it will protect you from modifying your EEPROM data carelessly.

### Syntax:

[ C ]
<code>void Disable_EEP(void)</code>

### Parameter:

None

**Return Value:**

None

**Example:**

```
Disable_EEP();
```

```
// After using this function, you will not use Write_EEP or Read_EEP to write or  
// read data of EEPROM.
```

**Remark:****Read\_EEP****Description:**

This function will read one byte data from the EEPROM. There is a 16K-byte EEPROM in the main control unit in the LP-8X81 Series system. This EEPROM is divided into 256 blocks (0 to 255), and each block is 64 bytes in length from offset 0 to 63. This EEPROM with its accessing APIs provides another mechanism for storing critical data inside non-volatile memory.

**Syntax:**

[ C ]
<code>unsigned char Read_EEP(int block, int offset)</code>

**Parameter:**

block : [Input] the block number of EEPROM.

offset : [Input] the offset within the block.

**Return Value:**

Data read from the EEPROM.

**Example:**

```
int block, offset;
```

```
unsigned char data;
```

```
data= ReadEEP(block, offset);
```

// Returned value: data= read an 8-bit value from the EEPROM (block & offset)

**Remark:**

## Write\_EEP

**Description:**

To write one byte of data to the EEPROM. There is a 16K-byte EEPROM in the main control unit of the LP-8X81 Series system. This EEPROM is divided into 256 blocks (0 to 255), and each block is 64 bytes in length from the offset of 0 to 63. This EEPROM with its accessing APIs, provides another mechanism for storing critical data inside non-volatile memory.

**Syntax:**

```
[ C ]  
  
void Write_EEP(int block, int offset, unsigned char data)
```

**Parameter:**

block : [Input] the block number of EEPROM.

offset : [Input] the offset within the block.

Data : [Input] data to write to EEPROM.

**Return Value:**

None

**Example:**

```
int block, offset;
```

```
unsigned char data=10;
```

```
WriteEEP(block, offset, data);
```

```
// Writes a 10 value output to the EEPROM (block & offset) location
```

**Remark:**

## 6.5 Analog Input Functions

### I8017\_Init

**Description:**

This function is used to initialize the I-8017H modules (Analog input module) into the specified slot. Users must execute this function before trying to use other functions within the I-8017H modules.

**Syntax:**

```
[ C ]  
  
int I8017_Init(int slot)
```

**Parameter:**

slot : [Input] specified slot of the LP-8X81 Series system (Range: 1 to 7)

**Return Value:**

The version of library

**Example:**

```
int slot=1,ver;  
ver=I8017_Init(slot);  
// The I-8017H card is plugged in slot 1 of LP-8X81 Series and initializes the module  
// I-8017H.
```

**Remark:**

This function can be applied on module: I-8017H and I-8017HS.

## I8017\_SetLed

**Description:**

Turns the I-8017H modules LED's on/off. They can be used to act as an alarm.

**Syntax:**

```
[ C ]  
  
void I8017_SetLed(int slot, unsigned int led)
```

**Parameter:**

slot : [Input] specified slot of the LP-8X81 Series system (Range: 1 to 7)

led : [Input] range from 0 to 0xffff

### Return Value:

None

### Example:

```
int slot=1;
unsigned int led=0x0001;
I8017_SetLed (slot, led);
// There will be a L/A-LED light on channel 0 of the I-8017H card which is plugged in
slot 1 on the LP-8X81 Series.
```

### Remark:

This function can be applied on module: I-8017H and I-8017HS.

## I8017\_SetChannelGainMode

### Description:

This function is used to configure the range and mode of the analog input channel for the I-8017H modules in the specified slot before using the ADC (analog to digital converter).

### Syntax:

```
[ C ]
void I8017_SetChannelGainMode (int slot, int ch, int gain, int mode)
```

### Parameter:

slot : [Input] Specify the slot in the LP-8X81 Series system (Range: 1 to 7)

ch : [Input] Specify the I-8017H channel (Range: 0 to 7)

Specify the I-8017HS channel (Range: 0 to 15)

gain : [Input] input range:

**0: +/- 10.0V,**

**1: +/- 5.0V,**

**2: +/- 2.5V,**

**3: +/- 1.25V,**

4: +/- 20mA.

mode : [Input] 0: normal mode (polling)

### Return Value:

None

### Example:

```
int slot=1,ch=0,gain=0;
```

```
I8017_SetChannelGainMode (slot, ch, gain,0);
```

```
// The I-8017H card is plugged in slot 1 of LP-8X81Series, and the range of the data
```

```
// value from channel 0 for I-8017H will be -10 ~ +10 V.
```

### Remark:

This function can be applied on module: I-8017H and I-8017HS.

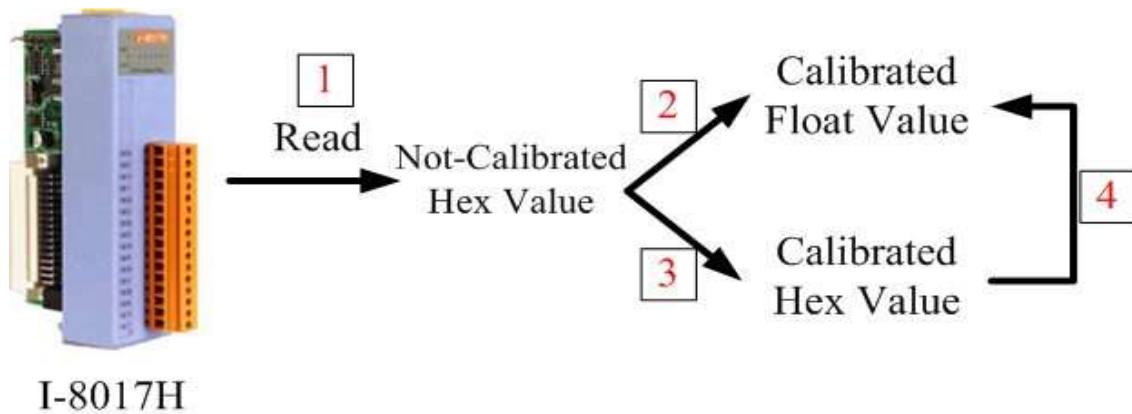

8017H Flow Diagram

Fig.6-2

## Function of [1]

### I8017\_GetCurAdChannel\_Hex

#### Description:

Obtains the non-calibrated analog input value in the Hex format from the analog input I-8017H modules. Please refer to Fig. 6-2

#### Syntax:

```
[ C ]  
int I8017_GetCurAdChannel_Hex (int slot)
```



**Parameter:**

slot : [Input] specified slot of the LP-8X81 Series system (Range: 1 to 7)

**Return Value:**

The analog input value in Hex format.

**Example:**

```
int slot=1,ch=0,gain=4;
```

```
int data;
```

```
I8017_SetChannelGainMode (slot, ch, gain,0);
```

```
data= I8017_GetCurAdChannel_Hex (slot);
```

```
// The I-8017H card is plugged into slot 1 of LP-8X81 Series and the range of the data
```

```
// value from channel 0 in I-8017H is +/- 20mA
```

**I8017\_AD\_POLLING****Description:**

This function is used to get the analog input non-calibrated hex values of the specified channel from an analog input module and can convert it to the value according to the slot configuration, the gain and the data number.

**Syntax:**

```
[ C ]  
  
int I8017_AD_POLLING(int slot, int ch, int gain, unsigned int datacount,  
                    int *DataPtr)
```

**Parameter:**

slot : [Input] Specified slot in the LP-8X81 Series system (Range: 1 to 7)

ch : [Input] Specified channel for I-8017H (Range: 0 to 7)

Specified channel for I-8017HS (Range: 0 to 15)

gain : [Input] Input range:

**0: +/- 10.0V,**

**1: +/- 5.0V,**

**2: +/- 2.5V,**

**3: +/- 1.25V,**

#### 4: +/- 20mA.

datacount : [Input] Range from 1 to 8192, total ADCs number

\*DataPtr : [Output] The starting address of data array[ ] and the array size must be equal to or bigger than the datacount.

#### Return Value:

0 : indicates success.

Not 0 : indicates failure.

#### Example:

```
int slot=1, ch=0, gain=0, data[10];
```

```
unsigned int datacount = 10;
```

```
I8017_AD_POLLING(slot, ch, gain, datacount, data);
```

```
// You gain ten not-calibrated hex values via channel 0 in the I-8017H module.
```

## Function of [2]

### HEX\_TO\_FLOAT\_Cal

#### Description:

This function is used to convert the data from not-calibrated hex to calibrated float values based on the configuration of the slot, gain. (Voltage or current). Please refer to the Fig. 6-2.

#### Syntax:

```
[ C ]  
float HEX_TO_FLOAT_Cal(int HexValue, int slot, int gain)
```

#### Parameter:

HexValue : [Input] specified not-calibrated HexValue before converting

slot : [Input] specified slot of the LP-8X81 Series system (Range: 1 to 7)

gain : [Input] Input range:

0: +/- 10.0V,

1: +/- 5.0V,

2: +/- 2.5V,

3: +/- 1.25V,

4: +/- 20mA.

### Return Value:

The Calibrated Float Value.

### Example:

```
int slot=1, ch=0, gain=0, hdata;  
float fdata;  
I8017_SetChannelGainMode (slot, ch, gain,0);  
hdata = I8017_GetCurAdChannel_Hex (slot);  
fdata = HEX_TO_FLOAT_Cal(hdata, slot, gain);  
// You can convert not-calibrated Hex Value to calibrated Float Value
```

### Remark:

This function can be applied on module: I-8017H and I-8017HS.

## ARRAY\_HEX\_TO\_FLOAT\_Cal

### Description:

This function is used to convert the data from non-calibrated hex values to calibrated float values in the array mode based on the slot's configuration. (Voltage or current). Please refer to Fig. 6-2.

### Syntax:

```
[ C ]  
void ARRAY_HEX_TO_FLOAT_cal(int *HexValue, float *FloatValue, int slot,  
                             int gain,int len)
```

### Parameter:

\*HexValue : [Input] data array in not-calibrated Hex type before converting

\*FloatValue : [Output] Converted data array in calibrated float type

slot : [Input] specified slot of the LP-8X81 Series system (Range: 1 to 7)

gain : [Input] Input range:

len : [input] ADC data length

**Return Value:**

None

**Example:**

```
int slot=1, ch=0, gain=0, datacount=10, hdata[10];  
float fdata[10];  
I8017_SetChannelGainMode (slot, ch, gain,0);  
I8017_AD_POLLING(slot, ch, gain, datacount, data);  
ARRAY_HEX_TO_FLOAT_Cal(data, fdata, slot, gain, len);  
// You can convert ten not-calibrated Hex values to ten calibrated Float values
```

**Remark:**

This function can be applied on module: I-8017H and I-8017HS.

## Function of [3]

### I8017\_Hex\_Cal

**Description:**

This function is used to convert the data from non-calibrated hex values to calibrated hex values. (Voltage or current). Please refer to Fig. 6-2.

**Syntax:**

[ C ]
<code>int I8017_Hex_Cal(int data)</code>

**Parameter:**

data : [Input] specified not-calibrated hex value

**Return Value:**

The Calibrated Hex Value.

**Example:**

```
int slot=1, ch=0, gain=0, hdata;  
int hdata_cal;  
I8017_SetChannelGainMode (slot, ch, gain,0);
```

```
hdata = I8017_GetCurAdChannel_Hex (slot);
hdata_cal = I8017_Hex_Cal (hdata);
// You can convert not-calibrated Hex Value to calibrated Hex Value
```

**Remark:**

This function can be applied on module: I-8017H and I-8017HS.

## I8017\_Hex\_Cal\_Slot\_Gain

**Description:**

This function is used to convert the data from non-calibrated hex values to calibrated hex values based on the configuration of the slot, gain. (Voltage or current).. (Voltage or current). Please refer to the Fig. 6-2.

**Syntax:**

[ C ]
<code>int I8017_Hex_Cal_Slot_Gain(int slot, int gain, int data)</code>

**Parameter:**

slot : [Input] specified slot of the LP-8X81 Series system (Range: 1 to 7)

gain : [Input] Input range:

data : [Input] specified not-calibrated hex value

**Return Value:**

The Calibrated Hex Value.

**Example:**

```
int slot=1, ch=0, gain=0, hdata;
int hdata_cal;
I8017_SetChannelGainMode (slot, ch, gain,0);
hdata = I8017_GetCurAdChannel_Hex (slot);
hdata_cal = I8017_Hex_Cal_Slot_Gain (slot, gain, hdata);
// You can convert not-calibrated Hex Value to calibrated Hex Value according to
// the gain of slot you choose.
```

**Remark:**

This function can be applied on module: I-8017H and I-8017HS.

## Function of [4]

### CalHEX\_TO\_FLOAT

#### Description:

This function is used to convert the data from calibrated hex values to calibrated float values based on the configuration of the gain. (Voltage or current). Please refer to Fig. 6-2.

#### Syntax:

```
[ C ]  
float CalHex_TO_FLOAT(int HexValue,int gain)
```

#### Parameter:

HexValue : [Input] specified not-calibrated HexValue before converting

gain : [Input] Input range:

- 0: +/- 10.0V,
- 1: +/- 5.0V,
- 2: +/- 2.5V,
- 3: +/- 1.25V,
- 4: +/- 20mA.

#### Return Value:

The Calibrated Float Value.

#### Example:

```
int slot=1, ch=0, gain=0, hdata, hdata_cal;  
float fdata;  
I8017_SetChannelGainMode (slot, ch, gain,0);  
hdata = I8017_GetCurAdChannel_Hex (slot);  
hdata_cal = I8017_HEX_Cal(hdata);  
fdata = CalHex_TO_FLOAT(hdata_cal, gain);  
// You can convert calibrated Hex Value to calibrated Float Value
```

#### Remark:

This function can be applied on module: I-8017H and I-8017HS.

## ARRAY\_CalHEX\_TO\_FLOAT

### Description:

This function is used to convert the data from calibrated hex values to calibrated float values in the array mode based on the configuration of the gain. (Voltage or current). Please refer to the Fig. 6-2.

### Syntax:

```
[ C ]  
void ARRAY_CalHex_TO_FLOAT(int *HexValue, float *FloatValue, int gain, int len)
```

### Parameter:

\*HexValue : [Input] data array in calibrated Hex format

\*FloatValue : [Output] Converted data array in calibrated float format

gain : [Input] Input range:

len : [input] ADC data length

### Return Value:

The Calibrated Float Value.

### Example:

```
int slot=1, ch=0, gain=0, hdata_cal[10];
```

```
float fdata[10];
```

```
fdata = ARRAY_CalHex_TO_FLOAT (hdata_cal, fdata, gain, len);
```

```
// You can convert ten calibrated Hex Values to ten calibrated Float Values.
```

### Remark:

This function can be applied on module: I-8017H and I-8017HS.

## Function of [1] + [3]

### I8017\_GetCurAdChannel\_Hex\_Cal

### Description:

Obtain the calibrated analog input values in the Hex format directly from the

analog input modules, I-8017H. This function is a combination of the “I8017\_GetCurAdChannel\_Hex” function and the “I8017\_Hex\_Cal”. Please refer to Fig 6-2

**Syntax:**

```
[ C ]  
  
int I8017_GetCurAdChannel_Hex_Cal(int slot)
```

**Parameter:**

slot : [Input] specified slot of the LP-8X81 Series system (Range: 1 to 7)

**Return Value:**

The analog input value in Calibrated Hex format.

**Example:**

```
int slot=1,ch=0,gain=0, data;  
I8017_SetChannelGainMode (slot, ch, gain,0);  
data = I8017_GetCurAdChannel_Hex_Cal (slot);  
// The I-8017H card is plugged into slot 1 of LP-8X81 Series and the range of the  
// data value from channel 0 in I-8017H is 0x0000 ~ 0x3fff.
```

**Remark:**

This function can be applied on module: I-8017H and I-8017HS.

**I8017\_AD\_POLLING\_Cal**

**Description:**

This function is used to get the analog input calibrated hex values in the array mode from an analog input module and can convert according to the slot configuration value, the gain and the data number.

**Syntax:**

```
[ C ]
```



```
int I8017_AD_POLLING_Cal(int slot, int ch, int gain, unsigned int datacount,  
                        int *DataPtr)
```

### Parameter:

slot : [Input] Specified slot in the LP-8X81 Series system (Range: 1 to 7)

ch : [Input] Specified channel for I-8017H (Range: 0 to 7)

Specified channel for I-8017HS (Range: 0 to 15)

gain : [Input] Input range:

**0: +/- 10.0V,**

**1: +/- 5.0V,**

**2: +/- 2.5V,**

**3: +/- 1.25V,**

**4: +/- 20mA.**

datacount : [Input] Range from 1 to 8192, total ADCs number

\*DataPtr : [Output] The starting address of data array[ ] and the array size must be equal to or bigger than the datacount.

### Return Value:

0 : indicates success.

Not 0 : indicates failure.

### Example:

```
int slot=1, ch=0, gain=0, data[10];
```

```
unsigned int datacount = 10;
```

```
I8017_AD_POLLING_Cal(slot, ch, gain, datacount, data);
```

```
// You gain ten calibrated hex values via channel 0 in the I-8017H module.
```

## Function of [1]+[2]

### I8017\_GetCurAdChannel\_Float\_Cal

#### Description:

Obtains the calibrated analog input value in the Float format directly from the analog i8017H input modules. This function is a combination of the

“I8017\_GetCurAdChannel\_Hex” function and the “Hex\_TO\_FLOAT\_Cal” function.

Please refer to Fig 6-2

**Syntax:**

```
[ C ]  
  
int I8017_GetCurAdChannel_Float_Cal(int slot)
```

**Parameter:**

slot : [Input] specified slot of the LP-8X81 Series system (Range: 1 to 7)

**Return Value:**

The analog input value in Calibrated Float format.

**Example:**

```
int slot=1,ch=0,gain=0;  
float data;  
I8017_SetChannelGainMode (slot, ch, gain,0);  
data = I8017_GetCurAdChannel_Float_Cal (slot);  
// The I-8017H card is plugged into slot 1 of LP-8X81 Series and the range of the  
// data value from channel 0 in I-8017H is -10V ~ +10V.
```

**Remark:**

This function can be applied on module: I-8017H and I-8017HS

## 6.6 Analog Output Functions

### I8024\_Initial

**Description:**

This function is used to initialize the I-8024 module in the specified slot. You must implement this function before you try to use the other I-8024 functions.

**Syntax:**

```
[ C ]
```

```
void I8024_Initial(int slot)
```

**Parameter:**

slot : [Input] Specify the LP-8X81 Series system slot (Range: 1 to 7)

**Return Value:**

None

**Example:**

```
int slot=1;
```

```
I8024_Initial(slot);
```

// The I-8024 card is plugged into slot 1 of LP-8X81 Series and initializes the I-8024 module.

**Remark:**

This function can be applied on module: I-8024.

## I8024\_VoltageOut

**Description:**

This function is used to send the voltage float value to the I-8024 module with the specified channel and slot in the LP-8X81 Series system.

**Syntax:**

```
[ C ]  
void I8024_VoltageOut(int slot, int ch, float data)
```

**Parameter:**

slot : [Input] Specified the LP-8X81 Series system slot (Range: 1 to 7)

ch : [Input] Output channel (Range: 0 to 3)

data : [Input] Output data with engineering unit (Voltage Output: -10~ +10)

**Return Value:**

None

**Example:**

```
int slot=1, ch=0;
float data=3.0f;
I8024_VoltageOut(slot, ch, data);
//The I-8024 module output the 3.0V voltage from the channel 0.
```

**Remark:**

This function can be applied on module: I-8024.

## I8024\_CurrentOut

**Description:**

This function is used to initialize the I-8024 module in the specified slot for current output. Users must call this function before trying to use the other I-8024 functions for current output.

**Syntax:**

```
[ C ]
void I8024_CurrentOut(int slot, int ch, float cdata)
```

**Parameter:**

slot : [Input] Specify the LP-8X81 Series system slot (Range: 1 to 7)

ch : [Input] Output channel (Range: 0 to 3)

cdata : [Input] Output data with engineering unit (Current Output: 0~20 mA)

**Return Value:**

None

**Example:**

```
int slot=1, ch=0;
float cdata=10.0f;
I8024_CurrentOut(slot, ch, data);
// Output the 10.0mA current from the channel 0 of I-8024 module.
```

**Remark:**

This function can be applied on module: I-8024.

## I8024\_VoltageHexOut

### Description:

This function is used to send the voltage value in the Hex format to the specified channel in the I-8024 module, which is plugged into the slot in the LP-8X81 Series system.

### Syntax:

```
[ C ]  
  
void I8024_VoltageHexOut(int slot, int ch, int hdata)
```

### Parameter:

slot : [Input] Specify the LP-8X81 Series system slot (Range: 1 to 7)

ch : [Input] Output channel (Range: 0 to 3)

hdata : [Input] Output data with hexadecimal

(data range: 0h ~ 3FFFh → Voltage Output: -10. ~ +10. V)

### Return Value:

None

### Example:

```
int slot=1, ch=0; data=0x3000;
```

```
I8024_VoltageHexOut(slot, ch, data);
```

```
// The I-8024 module output the 5.0V voltage from the channel 0.
```

### Remark:

This function can be applied on module: I-8024.

## I8024\_CurrentHexOut

### Description:

This function is used to send the current value in the Hex format to the specified channel in the analog output module I-8024, which is plugged into the slot in the

LP-8X81 Series system.

### Syntax:

```
[ C ]  
  
void I8024_CurrentHexOut(int slot, int ch, int hdata)
```

### Parameter:

slot : [Input] Specify the LP-8X81 Series system slot (Range: 1 to 7)

ch : [Input] Output channel (Range: 0 to 3)

hdata : [Input] Output data with hexadecimal

(data range: 0h ~ 3FFFh → Current Output: 0. ~ +20.mA)

### Return Value:

None

### Example:

```
int slot=1, ch=0; data=0x2000;
```

```
I8024_CurrentHexOut(slot, ch, data);
```

```
// Output the 10.0mA current from the channel 0 of I-8024 module.
```

### Remark:

This function can be applied on module: I-8024.

## 6.7 The Software Develop Toolkit Error Code

Error Code	Error ID
0	NoError
1	FunctionError
2	PortError
3	BaudRateError
4	DataError

5	StopError
6	ParityError
7	CheckSumError
8	ComPortNotOpen
9	SendThreadCreateError
10	SendCmdError
11	ReadComStatusError
12	StrCheck Error
13	CmdError
14	X
15	TimeOut
16	X
17	ModuleId Error
18	AdChannelError
19	UnderRange
20	ExceedRange
21	InvalidateCounterNo
22	InvalidateCounterValue
23	InvalidateGateMode
24	InvalidateChannelNo
25	ComPortInUse

---

## 7. Demo of LP-8X81 Series Modules With C Language

---

In this section, we will focus on examples for the description and application of the control sections on the I-7000/I-8000/I-87K series modules for use in the LP-8X81 Series. After user downloading the latest version of LP-8X81 Series SDK "LinPAC-8X81\_sdk.tar.gz" from the ftp path (Please refer to chapter 2), then user could use command "tar zxvf LinPAC-8X81\_sdk.tar.gz" to unzip SDK "LinPAC-8X81\_sdk.tar.gz" in the LP-8X81 Series, user can find all demo programs (include demo source code and executes file) in the "examples" directory.

### 7.1 I-7k Modules DIO Control Demo

This demo – **i7kdio.c** will illustrate how to control DI/DO with the I-7050 module (8 DO channels and 7 DI channels). The address and baudrate of the I-7050 module in the RS-485 network are 02 and 9600 separately.

The result of this demo allows the DO channels 0 ~ 7 output and DI channel 2 input. The source code of this demo program is as follows:

```
#include<stdio.h>
#include<stdlib.h>
#include "msw.h"

char szSend[80], szReceive[80], ans;
WORD wBuf[12];
float fBuf[12];

/* ----- */
int main()
{
    int wRetVal;

    // Check Open_Com3
    wRetVal = Open_Com(COM3, 9600, Data8Bit, NonParity, OneStopBit);
    if (wRetVal > 0) {
```



```

        printf("open port failed!\n");
        return (-1);
    }
    // ***** 7050 DO && DI Parameter *****
    wBuf[0] = 3;           // COM Port
    wBuf[1] = 0x02;       // Address
    wBuf[2] = 0x7050;     // ID
    wBuf[3] = 0;          // CheckSum disable
    wBuf[4] = 100;        // TimeOut , 100 msecond
    wBuf[5] = 0x0ff;     // 8 DO Channels On
    wBuf[6] = 0;         // string debug

    // 7050 DO Output
    wRetVal = DigitalOut(wBuf, fBuf, szSend, szReceive);
    if (wRetVal)
        printf("DigitalOut_7050 Error !, Error Code=%d\n", wRetVal);
        printf("The DO of 7050 : %u \n", wBuf[5]);

    // 7050 DI Input
    DigitalIn(wBuf, fBuf, szSend, szReceive);
    printf("The DI of 7050 : %u \n", wBuf[5]);
    Close_Com(COM3);
    return 0;
}

```

Follow the below steps to achieve the desired results :

### **STEP 1 : ( To transmit “LP-8X81sdk\_for\_linux.tar.gz” SDK to LP-8X81 Series )**

User could use WinSCP software or linux “scp” command to transmit “LP-8X81\_sdk\_for\_linux.tar.gz” from Windows or Linux PC to LP-8X81 Series, or you can use command “wget [http://ftp.icpdas.com/pub/cd/linpac/napdos/lp-8x8x/atom/sdk/linpac-8X81\\_sdk.tar.gz](http://ftp.icpdas.com/pub/cd/linpac/napdos/lp-8x8x/atom/sdk/linpac-8X81_sdk.tar.gz)” to download linpac-8X81\_sdk.tar.gz in LP-8X81 Series.

### **STEP 2 : ( To connect to LP-8X81 Series to execute i7kdio )**

User could use putty software to connect to LP-8X81 Series. User could refer to the “4.LP-8X81 Series System Settings” to know how to use Putty software to connect

to LP-8X81 Series.

### STEP 3 : (To execute i7kdio in the “LP-8X81sdk\_for\_linux/examples/i7k)

After users connect to LP-8X81 Series, user could find the demo “i7kdio” in the directory “LP-8X81sdk\_for\_linux/examples/i7k. The result of execution refers to Fig. 7-1.

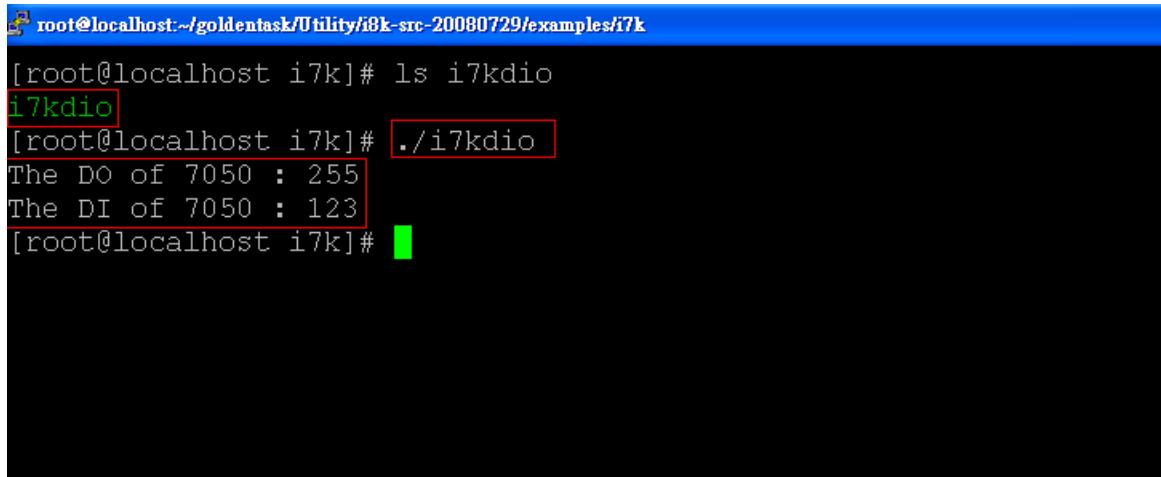

```
root@localhost:~/goldentask/Utility/i8k-src-20080729/examples/i7k
[root@localhost i7k]# ls i7kdio
i7kdio
[root@localhost i7k]# ./i7kdio
The DO of 7050 : 255
The DI of 7050 : 123
[root@localhost i7k]#
```

Fig. 7-1

“ The DO of I-7050 : 255 ( = $2^8-1$  )” means DO channel 0 ~ 7 will output and  
“ The DI of I-7050 : 123 ( = $127-2^2$  )” means there is input in DI channel 2.

## 7.2 I-7k Modules AIO Control Demo

This demo – **i7kaio.c** will illustrate how to control the AI/AO with the I-7017 (8 AI channels) and I-7021 modules ( 1 AO channel ). The address for the I-7021 and I-7017 modules are in the RS-485 network where 05 and 03 are separate and the baudrate is 9600.

The result of this demo allows the I-7021 module’s AO channel to output 3.5V and the I-7017’s AI channel 2 to input. The source code of this demo program is as follows :

```
#include<stdio.h>
#include<stdlib.h>
#include "msw.h"
```

```

char szSend[80], szReceive[80];
WORD wBuf[12];
float fBuf[12];

/* ----- */
int main()
{
    int i,j, wRetVal;
    DWORD temp;

    wRetVal = Open_Com(COM3, 9600, Data8Bit, NonParity, OneStopBit);
    if (wRetVal > 0) {
        printf("open port failed!\n");
        return (-1);
    }

    //--- Analog output ----   ****   7021 -- AO   ****
    i = 0;
    wBuf[0] = 3;                // COM Port
    wBuf[1] = 0x05;            // Address
    wBuf[2] = 0x7021;          // ID
    wBuf[3] = 0;                // CheckSum disable
    wBuf[4] = 100;             // TimeOut , 100 msecond
    //wBuf[5] = i;              // Not used if module ID is 7016/7021
                                // Channel No.(0 to 1) if module ID is 7022
                                // Channel No.(0 to 3) if module ID is 7024

    wBuf[6] = 0;                // string debug
    fBuf[0] = 3.5;             // Analog Value

    wRetVal = AnalogOut(wBuf, fBuf, szSend, szReceive);
    if (wRetVal)
        printf("AO of 7021 Error !, Error Code=%d\n", wRetVal);
    else
        printf("AO of 7021 channel %d = %f \n",i,fBuf[0]);

    //--- Analog Input ----   ****   7017 -- AI   ****
    j = 1;

```

```

wBuf[0] = 3;           // COM Port
wBuf[1] = 0x03;       // Address
wBuf[2] = 0x7017;     // ID
wBuf[3] = 0;          // CheckSum disable
wBuf[4] = 100;        // TimeOut , 100 msecond
wBuf[5] = j;          // Channel of AI
wBuf[6] = 0;          // string debug

wRetVal = AnalogIn(wBuf, fBuf, szSend, szReceive);
if (wRetVal)
    printf("AI of 7017 Error !, Error Code=%d\n", wRetVal);
else
    printf("AI of 7017 channel %d = %f \n",j,fBuf[0]);

Close_Com(COM3);

return 0;
}

```

All the steps from programming to execution are the same as those in the section 7.1. The result of execution refers to Fig. 7-2.



```

root@localhost:~/goldentask/Utility/i8k-src-20080729/examples/i7k
[root@localhost i7k]# ls i7kaio
i7kaio
[root@localhost i7k]# ./i7kaio
AO of 7021 channel 0 = 3.500000
AI of 7017 channel 1 = 3.500000
[root@localhost i7k]#

```

Fig. 7-2

## 7.3 I-87k Modules DIO Control Demo

When using I-87k modules for I/O control of the LP-8X81 Series, the program will be a little different, according to the location of I-87k modules. There are three conditions for the location of the I-87k modules:

- (1) When I-87k DIO modules are **in the LP-8X81 Series slots**, the two functions “ Open\_Slot ” and “ ChangeToSlot ”, must be added before using other functions for the I-87k modules and the function of “Close\_Slot() “ also needs to be added to the end of the program. Please refer to demo in section 7.3.1.
- (2) When I-87K DIO modules are **in the I-87k I/O expansion unit slots**, then please refer to the demo in section 7.3.2.
- (3) When the I-87k DIO modules are **in the I-8000 controller slots**, then the I-87k modules will be regarded as I-8k modules and so please refer to I/O control of I-8k modules in section 7.5.2

### 7.3.1 I-87k Modules in slots of LP-8X81 Series

This demo – **i87kdio.c** will illustrate how to control the DI/DO with the I-87054 module ( 8 DO channels and 8 DI channels). The I-87054 module is in slot 3 of the LP-8X81 Series. The address and baudrate in the LP-8X81 Series are constant and they are 00 and 115200 respectively. The result of this demo lets DO channel 0 ~ 7 of I-87054 output and DI channel 1 of I-87054 input. The source code of this demo program is as follows :

```
#include<stdio.h>
#include<stdlib.h>
#include "msw.h"

char szSend[80], szReceive[80];
DWORD dwBuf[12];
float fBuf[12];
```

```

/* ----- */
int main()
{
    int i, wRetVal;
    DWORD temp;

    //Check Open_Slot
    wRetVal = Open_Slot(0);
    if (wRetVal > 0) {
        printf("open Slot failed!\n");
        return (-1);
    }

    //Check Open_Com1
    wRetVal = Open_Com(COM1, 115200, Data8Bit, NonParity, OneStopBit);
    if (wRetVal > 0) {
        printf("open port failed!\n");
        return (-1);
    }

    //Choose Slot3
    ChangeToSlot(3);
    //--- digital output ---- **(DigitalOut_87k()**)
    dwBuf[0] = 1;           // COM Port
    dwBuf[1] = 00;         // Address
    dwBuf[2] = 0x87054;    // ID
    dwBuf[3] = 0;          // CheckSum disable
    dwBuf[4] = 100;        // TimeOut , 100 msecond
    dwBuf[5] = 0xff;       // digital output
    dwBuf[6] = 0;          // string debug
    wRetVal = DigitalOut_87k(dwBuf, fBuf, szSend, szReceive); // DO Output
    printf("DO Value= %u", dwBuf[5]);

    //--- digital Input ---- **(DigitalIn_87k()**)
    dwBuf[0] = 1;           // COM Port
    dwBuf[1] = 00;         // Address
    dwBuf[2] = 0x87054;    // ID

```

```

dwBuf[3] = 0;                // CheckSum disable
dwBuf[4] = 100;             // TimeOut , 100 msecond

dwBuf[6] = 0;                // string debug
getch();
Digitalln_87k(dwBuf, fBuf, szSend, szReceive); // DI Input
printf("DI= %u",dwBuf[5])
//--- digital output ----  ** Close DO **
dwBuf[0] = 1;                // COM Port
dwBuf[1] = 00;               // Address
dwBuf[2] = 0x87054;          // ID
dwBuf[3] = 0;                // CheckSum disable
dwBuf[4] = 100;             // TimeOut , 100 msecond
dwBuf[5] = 0x00;            // digital output
dwBuf[6] = 0;                // string debug
getch();                     // push any key to continue
wRetVal = DigitalOut_87k(dwBuf, fBuf, szSend, szReceive);

Close_Com(COM1);
Close_SlotAll();
return 0;
}

```

### 7.3.2 I-87k Modules in slots of I-87k I/O expansion unit

If the I-87k modules are in the slots of the I-87k I/O expansion unit, the above program needs to be modified in three parts :

- (1) The functions of **Open\_Slot()** , **ChangeToSlot()**, **Close\_SlotAll()** will be deleted.
- (2) The **address** and **baudrate** of I-87k modules in the network of RS-485 need to be set by DCON Utility
- (3) **Open com1**( internal serial port of LP-8X81 Series ) will be modified to **open com3** ( RS-485 port of LP-8X81 Series )

The address and baudrate of the I-87054 in the RS-485 network are set to be 06 and 9600 separately by the DCON Utility. The source code of this demo program –

**i87kdio\_87k.c** is as follows :

```
#include<stdio.h>
#include<stdlib.h>
#include "msw.h"

char szSend[80], szReceive[80];
DWORD dwBuf[12];
float fBuf[12];

/* ----- */
int main()
{
    int i, wRetVal;
    DWORD temp;
    //Check Open_Com3
    wRetVal = Open_Com(COM3, 9600, Data8Bit, NonParity, OneStopBit);
    if (wRetVal > 0) {
        printf("open port failed!\n");
        return (-1);
    }
    //--- digital output ---- **(DigitalOut_87k())**
    dwBuf[0] = 3;           // COM Port
    dwBuf[1] = 06;        // Address
    dwBuf[2] = 0x87054;     // ID
    dwBuf[3] = 0;          // CheckSum disable
    dwBuf[4] = 100;        // TimeOut , 100 msecond
    dwBuf[5] = 0xff;       // digital output
    dwBuf[6] = 0;          // string debug
    wRetVal = DigitalOut_87k(dwBuf, fBuf, szSend, szReceive); // DO Output
    printf("DO Value= %u", dwBuf[5]);

    //--- digital Input ---- **(DigitalIn_87k())**
    dwBuf[0] = 3;          // COM Port
    dwBuf[1] = 06;        // Address
    dwBuf[2] = 0x87054;   // ID
    dwBuf[3] = 0;        // CheckSum disable
    dwBuf[4] = 100;      // TimeOut , 100 msecond
```



```

dwBuf[6] = 0;           // string debug
getch();
DigitalIn_87k(dwBuf, fBuf, szSend, szReceive); // DI Input
printf("DI= %u",dwBuf[5]);
//--- digital output ----  ** Close DO **
dwBuf[0] = 3;           // COM Port
dwBuf[1] = 06;         // Address
dwBuf[2] = 0x87054;    // ID
dwBuf[3] = 0;          // CheckSum disable
dwBuf[4] = 100;        // TimeOut , 100 msecond
dwBuf[5] = 0x00;       // digital output
dwBuf[6] = 0;          // string debug
getch();               // push any key to continue
wRetVal = DigitalOut_87k(dwBuf, fBuf, szSend, szReceive);

Close_Com(COM3);
return 0;
}

```

All the steps from programming to execution are the same as those in the section 7.1. The result of execution refers to Fig. 7-3.

```

root@localhost:~/goldentask/Utility/i8k-src-20080729/examples/i87k
[root@localhost i87k]# ls i87kdio
i87kdio
[root@localhost i87k]# ./i87kdio
DO Value= 255
DI= 2
[root@localhost i87k]# █

```

Fig. 7-3

### 7.3.3 I-87k Modules in slots of I-8000 Controller

If the I-87k DIO modules are in the I-8000 controller slots, I-87k modules will be regarded as I-8k modules and so please refer to DI/DO control of I-8k modules in the section 7.5.

## 7.4 I-87k Modules AIO Control Demo

When using I-87k modules for I/O control of the LP-8X81 Series, according to the location of the I-87k modules, the program will be a little different. There are three conditions for the location of the I-87k modules :

- (1) When the I-87k AIO modules are **in the LP-8X81 Series slots**, the two functions “ Open\_Slot ” and “ ChangeToSlot ” must be added before using the other functions of the I-87k modules and the function “ Close\_Slot() ” also needs to be added to the end of the program. Please refer to the demo in section 7.4.1.
- (2) When I-87K AIO modules are **in the I-87k I/O expansion unit slots**, please refer to the demo in section 7.4.2.
- (3) When the I-87k AIO modules are **in the I-8000 controller slots**, the I-87k modules will be regarded as I-8k modules and so please refer to I/O control of I-8k modules in section 7.4.3.

### 7.4.1 I-87k Modules in slots of LP-8X81 Series

This demo – **i87kaio.c** will illustrate how to control the AI/AO with the I-87022 module ( 2 AO channels ) and the I-87017 module ( 8 AI channels ).The I-87022 and I-87017 modules are plugged into slot 2 and slot 3 of the LP-8X81 Series separately. The address and baudrate in the LP-8X81 Series are constant and they are 00 and 115200 separately. The result of this demo lets AO channel 0 of I-87022 output 2.5V and AI channel 1 of I-87017 input. The source code of this demo program is as follows :

```

#include<stdio.h>
#include<stdlib.h>
#include "msw.h"

char szSend[80], szReceive[80];
DWORD wBuf[12];
DWORD wBuf7[12];
float fBuf[12];
/* ----- */
int main()
{
    int i,j, wRetVal;
    DWORD temp;

    //Check Open_Slot
    wRetVal = Open_Slot(0);
    if (wRetVal > 0) {
        printf("open Slot failed!\n");
        return (-1);
    }

    //Check Open_Com1
    wRetVal = Open_Com(COM1, 115200, Data8Bit, NonParity, OneStopBit);
    if (wRetVal > 0) {
        printf("open port failed!\n");
        return (-1);
    }

    ChangeToSlot(2);
    //--- Analog output ---- **** 87022 -- AO ****
    i=0;
    wBuf[0] = 1;           // COM Port
    wBuf[1] = 0x00;       // Address
    wBuf[2] = 0x87022;    // ID
    wBuf[3] = 0;          // CheckSum disable
    wBuf[4] = 100;        // TimeOut , 100 msecond
    wBuf[5] = i;          // Channel Number of AO
    wBuf[6] = 0;          // string debug

```

```

fBuf[0] = 2.5;                // AO Value

wRetVal = AnalogOut_87k(wBuf, fBuf, szSend, szReceive);
if (wRetVal)
    printf("AO of 87022 Error !, Error Code=%d\n", wRetVal);
else
    printf("AO of 87022 channel %d = %f \n",i,fBuf[0]);

ChangeToSlot(3);
//--- Analog Input ----   ****   87017 -- AI   ****
j=1;
wBuf7[0] = 1;                // COM Port
wBuf7[1] = 0x00;             // Address
wBuf7[2] = 0x87017;          // ID
wBuf7[3] = 0;                // CheckSum disable
wBuf7[4] = 100;              // TimeOut , 100 msecond
wBuf7[5] = j;                //Channel Number of AI
wBuf7[6] = 0;                // string debug

wRetVal = AnalogIn_87k(wBuf7, fBuf, szSend, szReceive);
if (wRetVal)
    printf("AI of 87017 Error !, Error Code=%d\n", wRetVal);
else
    printf("AI of 87017 channel %d = %f \n",j,fBuf[0]);

Close_Com(COM1);
Close_SlotAll();
return 0;
}

```

## 7.4.2 I-87k Modules in slots of I-87k I/O expansion unit

If the I-87k modules are in slots of I-87k I/O expansion unit, the above program needs to be modified in three parts :

- (1) The functions of **Open\_Slot()** , **ChangeToSlot()**, **Close\_SlotAll()** will be deleted.
- (2) The **address** and **baudrate** of I-87k modules in the network of RS-485 need

to be set by DCON Utility

- (3) **Open com1** ( internal serial port of LP-8X81 Series ) will be modified to **open com3** ( RS-485 port of LP-8X81 Series )

The addresses I-87022 and I-87017 are in the RS-485 network and are set to be 01 and 02 separately and the baudrate is 9600 by DCON Utility. The source code of this demo program – **i87kaio\_87k.c** is as follows :

```
#include<stdio.h>
#include<stdlib.h>
#include "msw.h"

char szSend[80], szReceive[80];
DWORD wBuf[12];
DWORD wBuf7[12];
float fBuf[12];
/* ----- */
int main()
{
    int i,j, wRetVal;
    DWORD temp;
    //Check Open_Com3
    wRetVal = Open_Com(COM3, 9600, Data8Bit, NonParity, OneStopBit);
    if (wRetVal > 0) {
        printf("open port failed!\n");
        return (-1);
    }

    //--- Analog output ---- **** 87022 -- AO ****
    i=0;
    wBuf[0] = 3;           // COM Port
    wBuf[1] = 0x01;       // Address
    wBuf[2] = 0x87022;    // ID
    wBuf[3] = 0;          // CheckSum disable
    wBuf[4] = 100;        // TimeOut , 100 msecond
    wBuf[5] = i;          // Channel Number of AO
    wBuf[6] = 0;          // string debug
    fBuf[0] = 2.5;        // AO Value
```

```

        wRetVal = AnalogOut_87k(wBuf, fBuf, szSend, szReceive);
    if (wRetVal)
        printf("AO of 87022 Error !, Error Code=%d\n", wRetVal);
    else
        printf("AO of 87022 channel %d = %f \n",i,fBuf[0]);
//--- Analog Input ----  ****  87017 -- AI  ****
j=1;
wBuf7[0] = 3;           // COM Port
wBuf7[1] = 0x02;        // Address
wBuf7[2] = 0x87017;     // ID
wBuf7[3] = 0;           // CheckSum disable
wBuf7[4] = 100;         // TimeOut , 100 msecond
wBuf7[5] = j;           //Channel Number of AI
wBuf7[6] = 0;           // string debug
        wRetVal = AnalogIn_87k(wBuf7, fBuf, szSend, szReceive);
    if (wRetVal)
        printf("AI of 87017 Error !, Error Code=%d\n", wRetVal);
    else
        printf("AI of 87017 channel %d = %f \n",j,fBuf[0]);

Close_Com(COM3);
    return 0;
}

```

All the steps from programming to execution are the same as those in the section 7.1. The result of execution refers to Fig. 7- 4.

```

root@localhost:~/goldentask/Utility/i8k-src-20080729/examples/i87k
[root@localhost i87k]# ls i87kaio
i87kaio
[root@localhost i87k]# ./i87kaio
AO of 87022 channel 0 = 2.500000
AI of 87017 channel 1 = 2.507000
[root@localhost i87k]#

```

Fig. 7-4

### 7.4.3 I-87k Modules in slots of I-8000 Controller

If the I-87k AIO modules are in slots of I-8000 controller, I-87k modules will be regarded as I-8k modules and refer to AI/AO control of I-8k modules in the section 7.6.

## 7.5 I-8k Modules DIO Control Demo

**I8000.c** of Libi8k.a is the source file for i8k modules in slots of I-8000 controller. **Slot.c** of Libi8k.a is the source file for i8k modules in slots of LP-8X81 Series. Therefore the functions for i8k modules in slots of LP-8X81 Series and in slots of I-8000 controller are different completely. There are two conditions for the location of the I-8k modules :

- (1) When I-8K DIO modules are **in the LP-8X81 Series**, then please refer to the demo in section 7.5.1.
- (2) When I-8K DIO modules are **in the I-8000 controller**, then please refer to the demo in section 7.5.2.

### 7.5.1 I-8k Modules in slots of LP-8X81 Series

In this section, this demo program – **i8kdio.c** will introduce how to control the DI/DO with the I-8055 ( 8 DO channels and 8 DI channels ) module and it is plugged into slot 3 of the LP-8X81 Series.

The address and baudrate in the LP-8X81 Series are constant and they are 00 and 115200 separately. The result of this demo lets DO channel 0 ~7 of I-8055 output and DI channel 0 of I-8055 input. The source code of this demo program is as follows :

```
#include<stdio.h>
#include<stdlib.h>
#include "msw.h"
```

```
char szSend[80], szReceive[80];
DWORD dwBuf[12];
```

```

float fBuf[12];
/* ----- */
int main()
{
    int i,j, wRetVal;
    WORD DOval,temp;

    wRetVal = Open_Slot(3);
    if (wRetVal > 0) {
        printf("open Slot failed!\n");
        return (-1);
    }

    //I-8055_DO
    DO_8(3,255);
    printf("DO of I-8055 = 0x%x \n", 255);

    //I-8055_DI
    printf("DI of I-8055 = %x",DI_8(3));

    Close_Slot(3);
    return 0;
}

```

All the steps from programming to execution are the same as those in the section 7.1. The result of execution refers to Fig. 7-5.

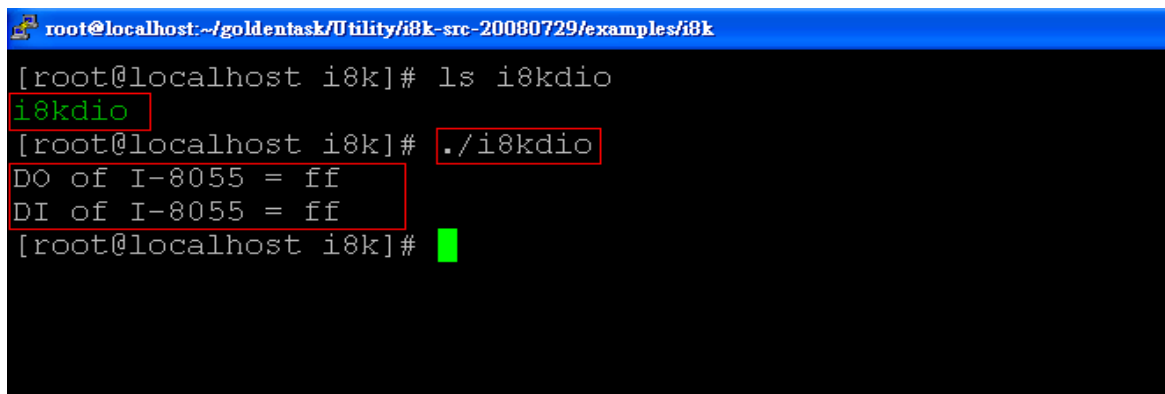

```

root@localhost:~/goldentask/Utility/i8k-src-20080729/examples/i8k
[root@localhost i8k]# ls i8kdio
i8kdio
[root@localhost i8k]# ./i8kdio
DO of I-8055 = ff
DI of I-8055 = ff
[root@localhost i8k]# █

```

Fig. 7-5



## 7.5.2 I-8k Modules in slots of I-8000 Controller

In this section, this demo program – **i8kdio\_8k.c** will illustrate how to control the DI/DO with the I-8055 ( 8 DO channels and 8 DI channels ) module. Please follow the below steps to configure the hardware :

- (1) Put the I-8055 module in slot 0 of I-8000 controller.
- (2) Install 8k232.exe or R232\_300.exe to flash memory of I-8000 controller as firmware.
- (3) Connect the **com3** of LP-8X81 Series to the com1 of I-8000 controller with the RS-232 cable.

The address of I-8000 controller is 01 and the baudrate is 115200 that can be modified by DCON Utility. The result of this demo lets DO channel 0 ~7 of I-8055 output and DI channel 0 of I-8055 input. The source code of this demo program is as follows :

```
#include<stdio.h>
#include<stdlib.h>
#include "msw.h"

char szSend[80], szReceive[80];
DWORD dwBuf[12];
float fBuf[12];

/* ----- */
int main()
{
    int i, wRetVal;
    DWORD temp;

    //Check Open_Com3
    wRetVal = Open_Com(COM3, 115200, Data8Bit, NonParity, OneStopBit);
    if (wRetVal > 0) {
        printf("open port failed!\n");
        return (-1);
    }
}
```

```

//--- digital output ----  **(DigitalOut_8K()**)
dwBuf[0] = 3;             // COM Port
dwBuf[1] = 01;           // Address
dwBuf[2] = 0x8055;       // ID
dwBuf[3] = 0;            // CheckSum disable
dwBuf[4] = 100;          // TimeOut , 100 msecond
dwBuf[5] = 0xff;         // digital output
dwBuf[6] = 0;            // string debug
dwBuf[7] = 1;            // slot number

wRetVal = DigitalOut_8K(dwBuf, fBuf, szSend, szReceive);
if (wRetVal)
    printf("DO of 8055 Error !, Error Code=%d\n", wRetVal);
else
    printf("DO of 8055 = 0x%x" ,dwBuf[5]);

//--- digital Input ----  **(DigitalIn_8K()**)
dwBuf[0] = 3;             // COM Port
dwBuf[1] = 01;           // Address
dwBuf[2] = 0x8055;       // ID
dwBuf[3] = 0;            // CheckSum disable
dwBuf[4] = 100;          // TimeOut , 100 msecond
dwBuf[6] = 0;            // string debug
dwBuf[7] = 1;            // slot number

getch();
DigitalIn_8K(dwBuf, fBuf, szSend, szReceive);
printf("DI = %u",dwBuf[5]);

//--- digital output ----  ** Close DO **
dwBuf[0] = 3;             // COM Port
dwBuf[1] = 01;           // Address
dwBuf[2] = 0x8055;       // ID
dwBuf[3] = 0;            // CheckSum disable
dwBuf[4] = 100;          // TimeOut , 100 msecond
dwBuf[5] = 0x00;         // digital output
dwBuf[6] = 0;            // string debug
dwBuf[7] = 1;            // slot number

```

```
getch(); // push any key to continue
wRetVal = DigitalOut_8K(dwBuf, fBuf, szSend, szReceive);
```

```
Close_Com(COM3);
return 0;
}
```

All the steps from programming to execution are the same as those in the section 7.1. The result of execution refers to Fig. 7-6.

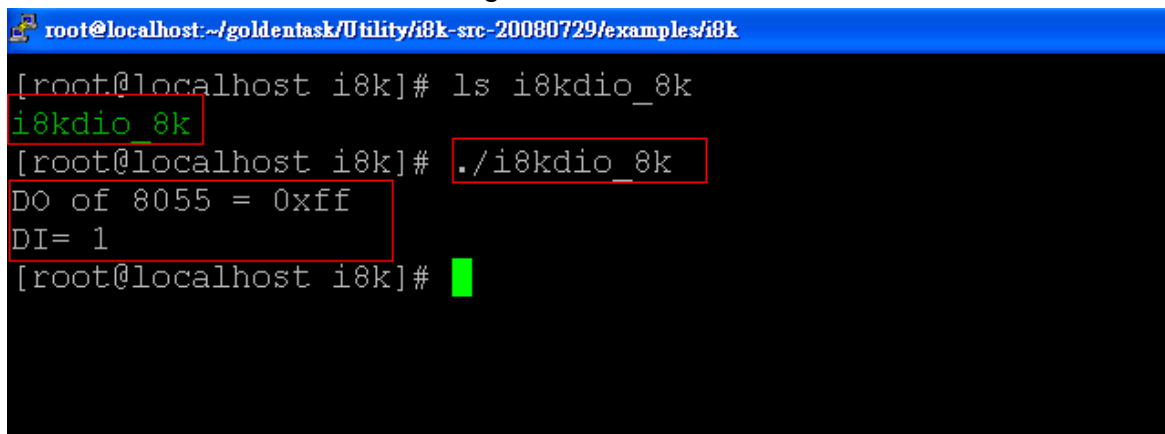

```
root@localhost:~/goldentask/Utility/i8k-src-20080729/examples/i8k
[root@localhost i8k]# ls i8kdio_8k
i8kdio_8k
[root@localhost i8k]# ./i8kdio_8k
DO of 8055 = 0xff
DI= 1
[root@localhost i8k]#
```

Fig. 7-6

## 7.6 I-8k Modules AIO Control Demo

**I8000.c** of Libi8k.a is the source file for i8k modules in slots of I-8000 controller. **Slot.c** of Libi8k.a is the source file for i8k modules in slots of the LP-8X81 Series. Therefore the functions for the i8k modules in LP-8X81 Series slots and in the I-8000 controller slots are completely different. There are two conditions for the location of the I-8k modules :

- (1) When I-8K AIO modules are **in the LP-8X81 Series**, then please refer to the demo in section 7.6.1.
- (2) When I-8K AIO modules are **in the I-8000 controller**, then please refer to the demo in section 7.6.2.

### 7.6.1 I-8k Modules in slots of LP-8X81 Series

In this section, this demo program – **i8kaio.c** will illustrate how to control the AI/AO with the I-8024 ( 4 AO channels ) and I-8017 ( 8 AI channels ) module and they

are in slot 1 and slot 2 of the LP-8X81 Series separately.

The address and baudrate in the LP-8X81 Series are constant and they are 00 and 115200 separately. The result of this demo lets AO voltage channel 0 of I-8024 output 5.5V and AI channel 2 of I-8017H input. The source code of this demo program is as follows :

```
#include<stdio.h>
#include<stdlib.h>
#include "msw.h"

char szSend[80], szReceive[80];
DWORD dwBuf[12];
float fBuf[12];

/* ----- */
int main()
{
    int i, wRetVal,j;
    float fAi;
    int hAi, chAi, Succ;
    int Arr_hAi[5];
    float Arr_fAi[5];

    //I-8024
    wRetVal = Open_Slot(1);
    if (wRetVal > 0) {
        printf("open Slot failed!\n");
        return (-1);
    }

    //I8024 Initial
    I8024_Initial(1);

    //I8024_AO Output
    I8024_VoltageOut(1,0,5.5);
    Close_Slot(1);

    /*****/
}
```

```

//I-8017H
wRetVal = Open_Slot(2);
if (wRetVal > 0) {
    printf("open Slot failed!\n");
    return (-1);
}

//I8017H Initial
I8017_Init(2);
//I8017H _Channel Setup
I8017_SetChannelGainMode(2,2,0,0);

// First Method : Get AI Value
hAi = I8017_GetCurAdChannel_Hex(2); //Get Not-calibrated AI Hex Value
printf("8017_AI_not_Cal_Hex =%x\n",hAi);
fAi = HEX_TO_FLOAT_Cal(hAi,2,0); //Not-calibrated AI Hex Value modify
to calibrated AI Float Value
printf("8017_AI_Cal_Float =%f\n\n",fAi);

// Second Method : Get AI Value
hAi = I8017_GetCurAdChannel_Hex_Cal(2); //Get Calibrated AI Hex Value
printf("8017_AI_Cal_Hex =%x\n",hAi);
fAi = CalHex_TO_FLOAT(hAi,0); //Calibrated AI Hex Value modify
to Calibrated AI Float Value
printf("8017_AI_Cal_Float =%f\n\n",fAi);

// Third Method : Get AI Value
fAi = I8017_GetCurAdChannel_Float_Cal(2); //Get Calibrated AI Float Value
printf("8017_AI_Cal_Float =%f\n\n\n",fAi);

Close_Slot(2);
return 0;
}

```

All the steps from programming to execution are the same as those in the section 7.1. The result of execution refers to Fig. 7-7.

```
root@localhost:~/goldentask/Utility/i8k-src-20080729/examples/i8k
[root@localhost i8k]# ls i8kaio
i8kaio
[root@localhost i8k]# ./i8kaio
8017_AI_not_Cal_Hex =113b
8017_AI_Cal_Float =5.499573

8017_AI_Cal_Hex =4669
8017_AI_Cal_Float =5.500793

8017_AI_Cal_Float =5.500793

[root@localhost i8k]# █
```

Fig. 7-7

## 7.6.2 I-8k Modules in slots of I-8000 Controller

In this section, this demo program – **i8kaio\_8k.c** will introduce how to control the AI/AO with the I-8024 ( 4 AO channels ) and I-8017 ( 8 AI channels ) module and they are plugged into slot 0 and slot 1 of the I-8000 controller separately. Please follow the below steps to configure the hardware :

- (1) Put the I-8024 and I-8017 modules in slot 0 and slot 1 of I-8000 controller.
- (2) Install 8k232.exe or R232\_300.exe to flash memory of I-8000 controller as firmware.
- (3) Connect **com3** of LP-8X81 Series to com1 of I-8000 controller with RS-232 cable.

The address and baudrate of I-8000 controller are 01 and 115200 that can be modified by DCON Utility. The result of this demo lets AO voltage channel 0 of 8024 output 3.5V and AI channel 2 of 8017H input. The source code of this demo program is as follows :

```
#include<stdio.h>
#include<stdlib.h>
#include "msw.h"
```

```

char szSend[80], szReceive[80];
DWORD wBuf[12];
float fBuf[12];

/* ----- */
int main()
{
    int i,j, wRetVal;
    DWORD temp;

    wRetVal = Open_Com(COM3, 115200, Data8Bit, NonParity, OneStopBit);
    if (wRetVal > 0) {
        printf("open port failed!\n");
        return (-1);
    }

    //--- Analog output ----  ****   8024 -- AO   ****
    i = 0;
    wBuf[0] = 3;           // COM Port
    wBuf[1] = 0x01;       // Address
    wBuf[2] = 0x8024;     // ID
    wBuf[3] = 0;          // CheckSum disable
    wBuf[4] = 100;        // TimeOut , 100 msecond
    wBuf[5] = i;          // Channel No. of AO
    wBuf[6] = 0;          // string debug
    wBuf[7] = 0;          // Slot Number
    fBuf[0] = 3.5;

    wRetVal = AnalogOut_8K(wBuf, fBuf, szSend, szReceive);
    if (wRetVal)
        printf("AO of 8024 Error !, Error Code=%d\n", wRetVal);
    else
        printf("AO of 8024 channel %d = %f \n",i,fBuf[0]);

    //--- Analog Input ----  ****   8017H -- AI   ****
    j = 2;
    wBuf[0] = 3;           // COM Port

```

```

wBuf[1] = 0x01;           // Address
wBuf[2] = 0x8017;        // ID
wBuf[3] = 0;             // CheckSum disable
wBuf[4] = 100;          // TimeOut , 100 msecond
wBuf[5] = j;            // Channel of AI
wBuf[6] = 0;           // string debug
wBuf[7] = 1;           // Slot Number

wRetVal = AnalogIn_8K(wBuf, fBuf, szSend, szReceive);
if (wRetVal)
    printf("AI of 8017H Error !, Error Code=%d\n", wRetVal);
else
    printf("AI of 8017H channel %d = %f \n",j,fBuf[0]);

Close_Com(COM3);
return 0;
}

```

All the steps from programming to execution are the same as those in the section 7.1. The result of execution refers to Fig. 7-8

```

root@localhost:~/goldentask/Utility/i8k-src-20080729/examples/i8k
[root@localhost i8k]# ls i8kaio_8k
i8kaio_8k
[root@localhost i8k]# ./i8kaio_8k
AO of 8024 channel 0 = 3.500000
AI of 8017H channel 1 = 3.504000
[root@localhost i8k]#

```

Fig. 7-8

## 7.7 Conclusion of Module Control Demo

Fig. 7-9 is the table of communication functions for the I-7000/I-8000/I-87000 modules in different locations. When using the ICP DAS modules in the LP-8X81 Series, this table will be helpful to let users understand which functions of communication should be used.



Module Location \ Communication Functions	Open_Slot()	Open_Com()	ChangeToSlot()	Close_Com()	Close_Slot()
I-7k		●		●	
I-8k or I-87K - In I-8000 Controller		●		●	
I-87K - In Expansion Unit		●		●	
I-87K - In LinCon-8000	●	●	●	●	●
I-8K - In LinCon-8000	●				●

Fig 7-9

Fig. 7-10 is the table of source files for the I-7000/I-8000/I-87000 modules in different locations. When using ICP DAS modules in the LP-8X81 Series, this table will be helpful to let users understand which source files of the libi8k.a should be called.

Module Location \ Source File	I7000.c	I8000.c	I87000.c	Slot.c
I-7k	●			
I-8k or I-87K - In I-8000 Controller		●		
I-87K - In Expansion Unit			●	
I-87K - In LinCon-8000			●	
I-8K - In LinCon-8000				●

Fig. 7-10

---

## 8. LP-8X81 Series Library Reference in C Language

---

In this chapter, all the functions of **libi8k** will be listed to allow users to be able to look them up quickly.

### 8.1 List Of System Information Functions

```
void ChangeToSlot(char slot)
int Open_Slot(int slot)
void Close_Slot(int slot)
int Open_Slot(void)
void Close_SlotAll(void)
int GetModuleType(char slot)
int GetNameOfModule(char slot)
```

### 8.2 List Of Digital Input/Output Functions

```
void DO_8(int slot, unsigned char data)
void DO_16(int slot, unsigned int data)
void DO_32(int slot, unsigned int data)
unsigned char DI_8(int slot)
unsigned int DI_16(int slot)
unsigned long DI_32(int slot)
void DIO_DO_8(int slot, unsigned char data)
void DIO_DO_16(int slot, unsigned int data)
unsigned char DIO_DI_8(int slot)
unsigned char DIO_DI_16(int slot)
unsigned short UDIO_WriteConfig_16
unsigned short UDIO_ReadConfig_16
void UDIO_DO16(int slot, unsigned short config)
unsigned short UDIO_DI16(int slot)
```

### 8.3 List Of Watch Dog Timer Functions

void EnableWDT(unsigned int msecond)  
void DisableWDT(void)  
unsigned int WatchDogSWEven(void)  
void ClearWDTSWEven(unsigned int rcsr)

### 8.4 List Of EEPROM Read/Write Functions

void Enable\_EEP(void)  
void Disable\_EEP(void)  
unsigned char Read\_EEP(int block, int offset)  
void Write\_EEP(int block, int offset, unsigned char data)

### 8.5 List Of Analog Input Functions

int I8017\_Init(int slot)  
void I8017\_SetLed(int slot, unsigned int led)  
void I8017\_SetChannelGainMode (int slot, int ch, int gain, int mode)  
int I8017\_GetCurAdChannel\_Hex (int slot)  
int I8017\_AD\_POLLING(int slot, int ch, int gain, unsigned int datacount, int  
\*DataPtr)  
float HEX\_TO\_FLOAT\_Cal(int HexValue, int slot, int gain)  
void ARRAY\_HEX\_TO\_FLOAT\_Cal(int \*HexValue, float \*FloatValue, int slot,  
int gain,int len)  
int I8017\_Hex\_Cal(int data)  
int I8017\_Hex\_Cal\_Slot\_Gain(int slot, int gain, int data)  
float CalHex\_TO\_FLOAT(int HexValue,int gain)  
void ARRAY\_CalHex\_TO\_FLOAT(int \*HexValue, float \*FloatValue, int gain, int  
len)  
int I8017\_GetCurAdChannel\_Hex\_Cal(int slot)  
int I8017\_AD\_POLLING\_Cal(int slot, int ch, int gain, unsigned int datacount,

```
int *DataPtr)  
int I8017_GetCurAdChannel_Float_Cal(int slot)
```

## 8.6 List Of Analog Output Functions

```
void I8024_Initial(int slot)  
void I8024_VoltageOut(int slot, int ch, float data)  
void I8024_CurrentOut(int slot, int ch, float cdata)  
void I8024_VoltageHexOut(int slot, int ch, int hdata)  
void I8024_CurrentHexOut(int slot, int ch, int hdata)
```

---

## 9. Additional Support

---

In this chapter, ICP DAS provides extra module supported and instructions to enhance LP-8X81 Series functionality and affinity.

### 9.1 N-Port Serial Port and Modules Driver Install

The comport linux driver can be used in LP-8X81 Series to support serial modules (e.g. i-8114w), COM4 and COM5. For LP-8X81 Series Linux OS, the recommended in installation and uninstall steps as follows:

- (1) To type “**cd /etc/init.d/**” and type “**./comport.inst**” to install serial module driver automatically (refer to Fig 9-1).

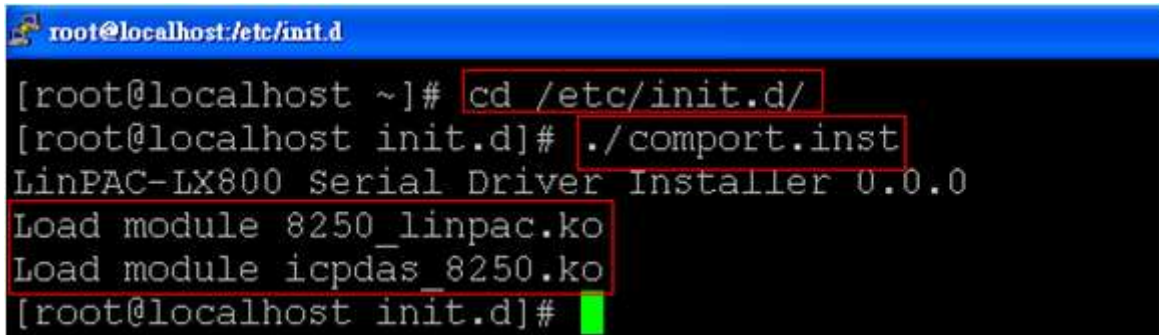

```
root@localhost:/etc/init.d
[root@localhost ~]# cd /etc/init.d/
[root@localhost init.d]# ./comport.inst
LinPAC-LX800 Serial Driver Installer 0.0.0
Load module 8250_linpac.ko
Load module icpdas_8250.ko
[root@localhost init.d]#
```

Fig 9-1

- (2) To type “**dmesg**” to check the status of installing comport driver.
- (3) If user want to remove the comport driver, user could type “**cd /etc/init.d/**” and type “**./comport.remove**” to remove comport driver automatically (refer to 9-2).

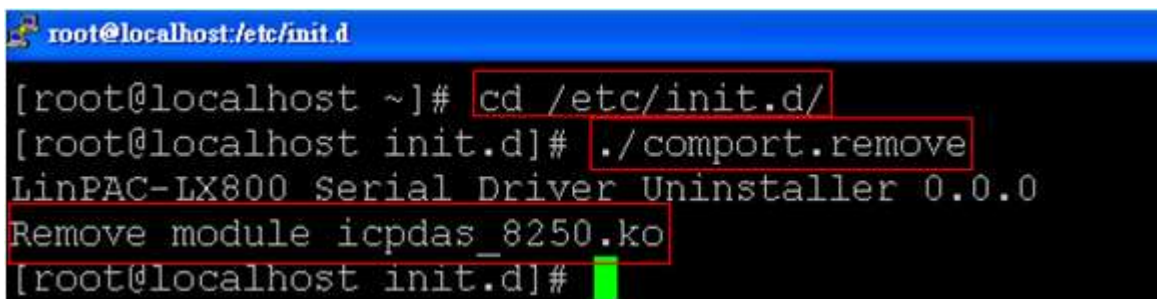

```
root@localhost:/etc/init.d
[root@localhost ~]# cd /etc/init.d/
[root@localhost init.d]# ./comport.remove
LinPAC-LX800 Serial Driver Uninstaller 0.0.0
Remove module icpdas_8250.ko
[root@localhost init.d]#
```

Fig 9-2

## 9.2 N-Port Module (i-8114w or other serial modules) Support

The **i-8114w** modules provide **four serial ports** respectively. Users can insert them into the LP-8X81 Series slots. In this way, users can use more serial ports in the LP-8X81 Series and the expanded maximum number of serial port in the LP-8X81 Series will be twenty-eight. The LP-8X81 Series is a multi-tasking unit, therefore users can control all the serial ports simultaneously. **The serial port number** of i-8114w modules are presented in the Fig 9-3 and it is **fixed** according to their slot position in the LP-8X81 Series.

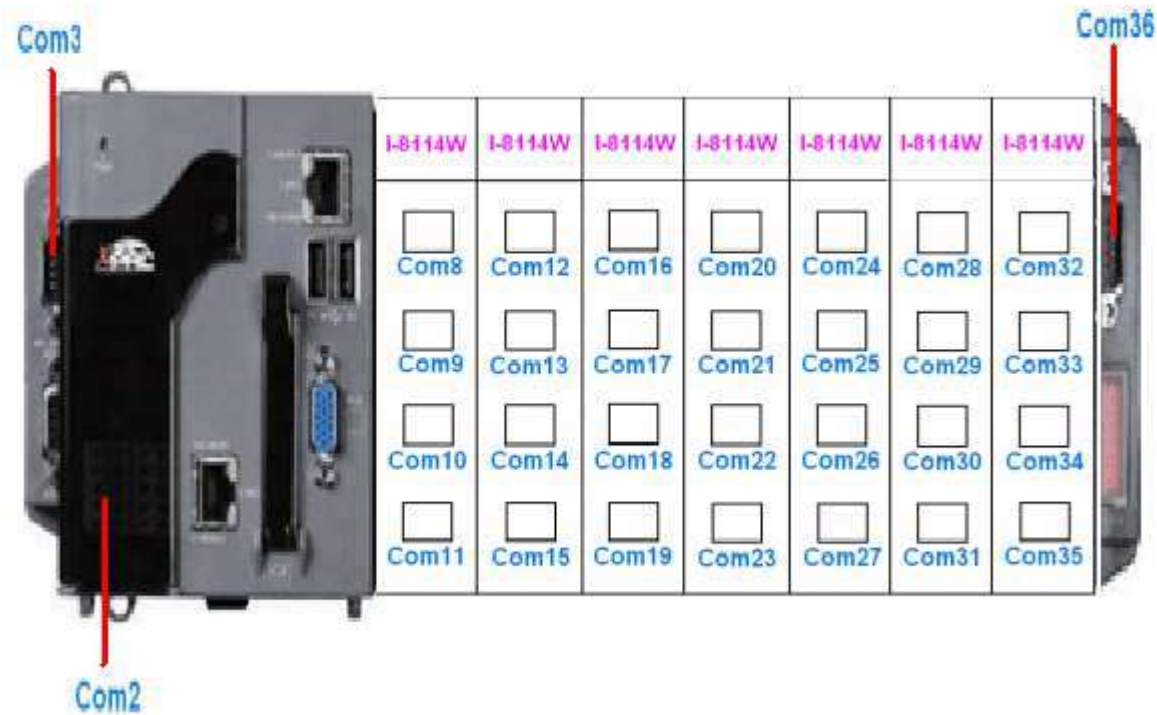

Fig 9-3

Fig.9-4 is the serial port number corresponding to the **device name** in the LP-8781.

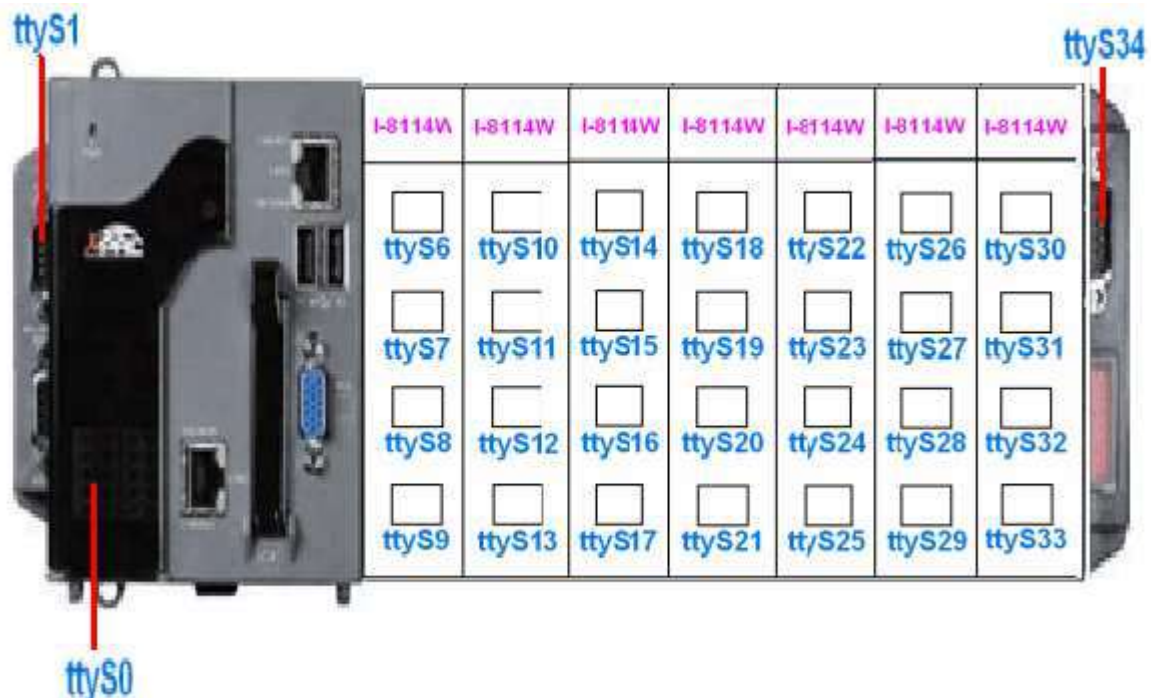

Fig 9-4

### 9.3 Rescue Disk

The rescue disk (8GB compact flash) can be used to recover LP-8X81 Series Linux system. If user's LP-8X81 Series Linux system couldn't startup successfully, user could follow below steps to recover Linux system with the rescue disk at local.

#### (1) For LinPAC-8X81-Atom

##### Step 1: To change the boot priority of disk in BIOS

- (1) After boot LinPAC-8x81-Atom, typing "delete" to go into BIOS.
- (2) In the "Boot" item, choosing the boot disk "SATA:PS-Flash Module".
- (3) Saving the changes and exit BIOS.

##### Step 2: To recover LP-8X81-Atom Linux OS

- (1) Type the user's ID(root) and password(icpdas) to login.
- (2) Type command "setup-control" to recover LP-8X81-Atom Linux OS automatically(Please refer to the Fig 9-5).

```
[root@localhost ~]# setup-control
Format Disk /dev/sda1 ..... [ OK ]
Install Lincon File System ..... [ OK ]
Setup Boot Loader ..... [ OK ]
```

Fig 9-5

- (3) After recovering the LP-8X81-Atom Linux OS successfully, user could type the command “reboot” to restart system.

**Step 3: To recover the boot priority of disk in BIOS**

- (1) After boot LinPAC-8x81-Atom, typing “delete” to go into BIOS.
- (2) In the “Advanced BIOS Features” item, choosing “First Boot Device” HDD-0.
- (3) Saving the changes and exit BIOS.

**(2)For LinPAC-8X81**

**Step 1: To change the boot priority of disk in BIOS**

- (1) After boot LinPAC-8x81, typing “delete” to go into BIOS.
- (2) In the “Advanced BIOS Features” item, choosing “First Boot Device” HDD-1.
- (3) Saving the changes and exit BIOS.

**Step 2: To recover LP-8X81 Linux OS**

- (1) Type the user’s ID(root) and password(icpdas) to login.
- (2) Type command “setup-control” to recover LP-8X81 Linux OS automatically(Please refer to the Fig 9-6).

```
[root@localhost ~]# setup-control
Format Disk /dev/hda1 ..... [ OK ]
Install Lincon File System ..... [ OK ]
Setup Boot Loader ..... [ OK ]
```

Fig 9-6

- (3) After recovering the LP-8X81 Linux OS successfully, user could type the command “reboot” to restart system.

**Step 3: To recover the boot priority of disk in BIOS**

- (1) After boot LinPAC-8x81, typing “delete” to go into BIOS.
- (2) In the “Advanced BIOS Features” item, choosing “First Boot Device” HDD-0.
- (3) Saving the changes and exit BIOS.



## 9.4 GUI Funtion Support

Now “X-window” is supported in the LP-8X81 Series and when the LP-8X81 Series boot up, the GUI like “Windows screen” will show up. The most important thing is that users can write GUI programs and run them in the LP-8X81 Series, The GUI Library in the LP-8X81 Series is provided with **GTK+** Library. Therefore users can design their own “**SCADA**” screen by the GTK+ Library in the LP-8X81 Series. In the meanwhile, we provide some GUI demo programs to control I/O modules of ICP DAS and assist users to develop own GUI programs quickly. After user download the latest version of LP-8X81 Series SDK “LinPAC-8X81\_sdk.tar.gz” from the ftp path (please refer to chapter 2), then user could use command “**tar zxvf LinPAC-8X81\_sdk.tar.gz**” to unzip SDK “LinPAC-8X81\_sdk.tar.gz” in the LP-8X81 Series, user can find all GUI demo programs(include demo source code and executes file) in the “examples/gui” directory. ( Refer to the Fig. 9-7 )

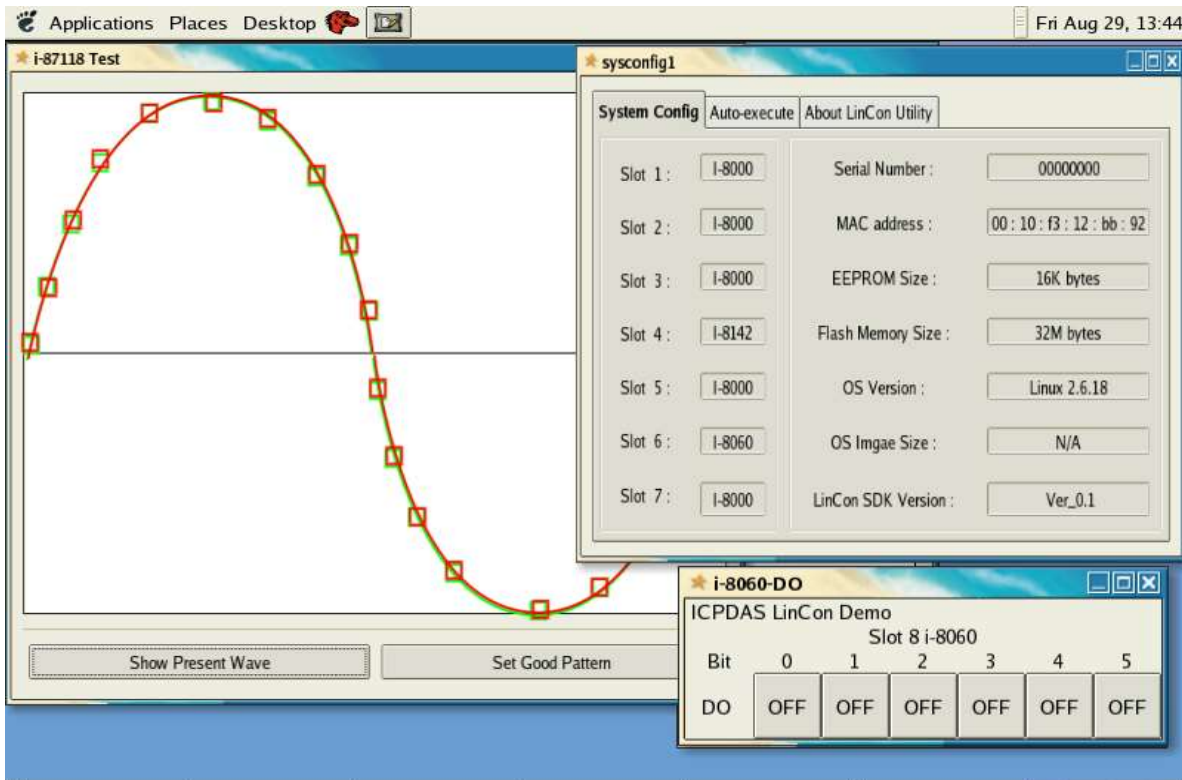

Fig. 9-7

### 9.4.1 How to boot LP-8X81 Series without loading X-window

LP-8X81 Series can boot without loading X-window by the steps as follows :

- (1) To type “ **vi /etc/inittab** “ to modify run level(default run level is 5).
- (2) To change run level from 5 to 3(please refer to Fig 9-8), then type “reboot” to restart LP-8X81 Series.

```

# 3 - Full multiuser mode
# 4 - unused
# 5 - X11
# 6 - reboot (Do NOT set initdefault to this)
#
id:5:initdefault: To change run level from 5 to 3, the X-window wouldn't loading
                    at boot time.
# System initialization.
si::sysinit:/etc/rc.d/rc.sysinit

l0:0:wait:/etc/rc.d/rc 0
#l1:1:wait:/etc/rc.d/rc 1
#l2:2:wait:/etc/rc.d/rc 2
l3:3:wait:/etc/rc.d/rc 3
#l4:4:wait:/etc/rc.d/rc 4
l5:5:wait:/etc/rc.d/rc 5
l6:6:wait:/etc/rc.d/rc 6

```

Fig 9-8

### 9.4.2 Enabling X-window load at boot time

LP-8X81 Series can boot and loading X-window at the same time by the steps as follows:

- (1) To type “ **vi /etc/inittab** “ to modify run level.
- (2) To change run level from 3 to 5 (please refer to Fig 9-7), then type “reboot” to restart LP-8X81 Series.

## 9.5 Application Support

There are many applications in the LP-8X81 Series.

### (1) Provide Web Browser

Users can see the Web Page by using the Web Browser built in the LP-8X81 Series. Just click the icon “firefox” (refer to Fig 9-9) to open the web browser.



Fig 9-9

## (2) Provide Apache Server

The Web Server — “**Apache Server**” has been built in the LP-8X81 Series and it will be started automatically at boot time (default the system wouldn't startup apache server at boot time, if user want to startup web server at boot time, user can create the S56httpd symbolic link in the directory “/etc/rc5.d” for turn on running program automatically at boot time), please refer to Fig 9-10.

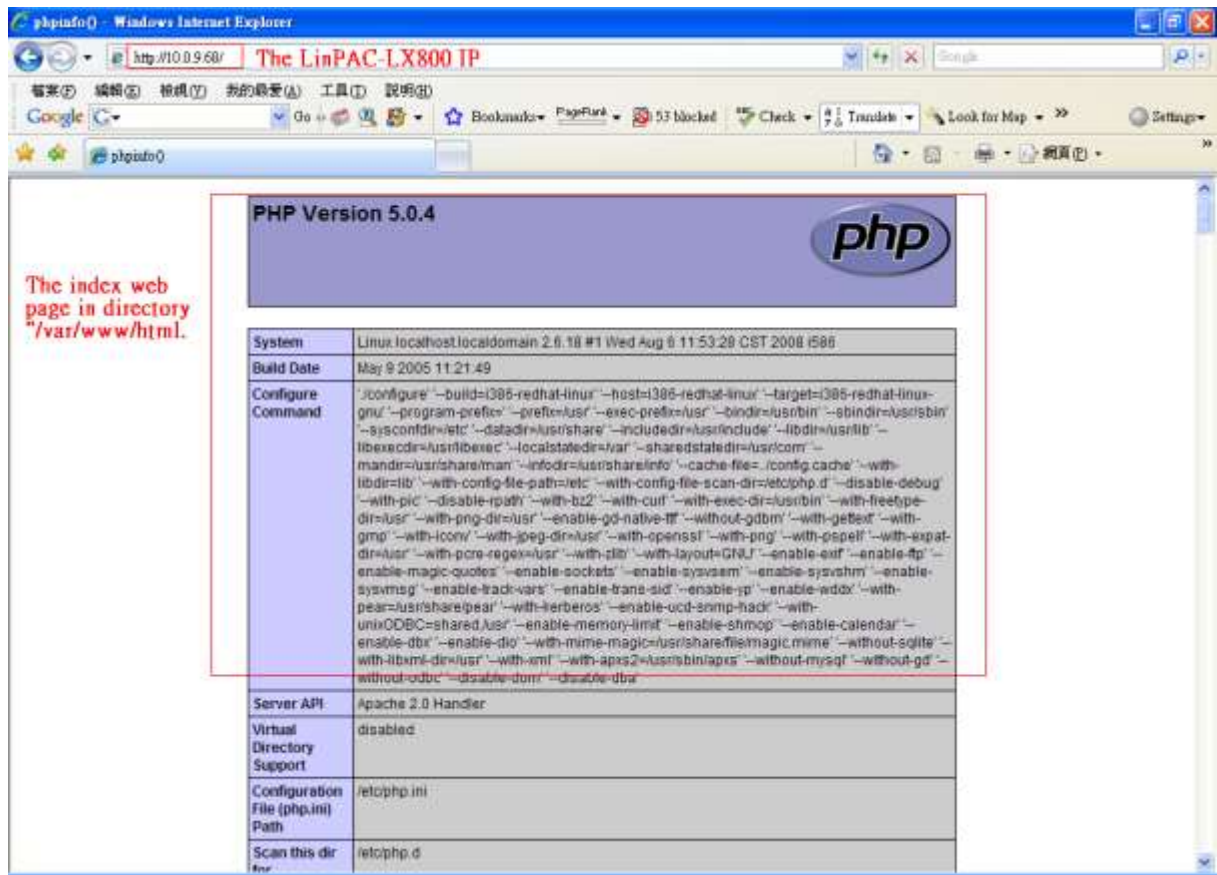

Fig 9-10

### (3)Using “yum” to Install Application

“yum” is so software installation tool for Red hat Linux and Fedora Linux. It is a complete software management system. The “yum” is designed to use over network/internet. If you want to install more application, you could use “yum ” to install automatically.

## 9.6 Other Optional Function

These optional functions are listed below all supported in the LP-8X81 Series.

### (1) Support MySQL

MySQL is a small database server and it is “ Relational DataBase Management System ( RDBMS ) “. By using MySQL, users can add or delete data easily and it is

open source and supports many platforms, like UNIX \ Linux or Windows operating system. If users want to startup MySQL server at boot time (default system wouldn't startup mysql server at boot time), user could follow under steps:

- (1) Type “ `cd /etc/rc5.d` “ to into default run level(please refer to Fig 9-10).
- (2) Type ” `ln -sv ../init.d/mysqld $60mysql` “ to make a symbolic link into the script file and it will be executed automatically at boot time(please refer to Fig 9-11).

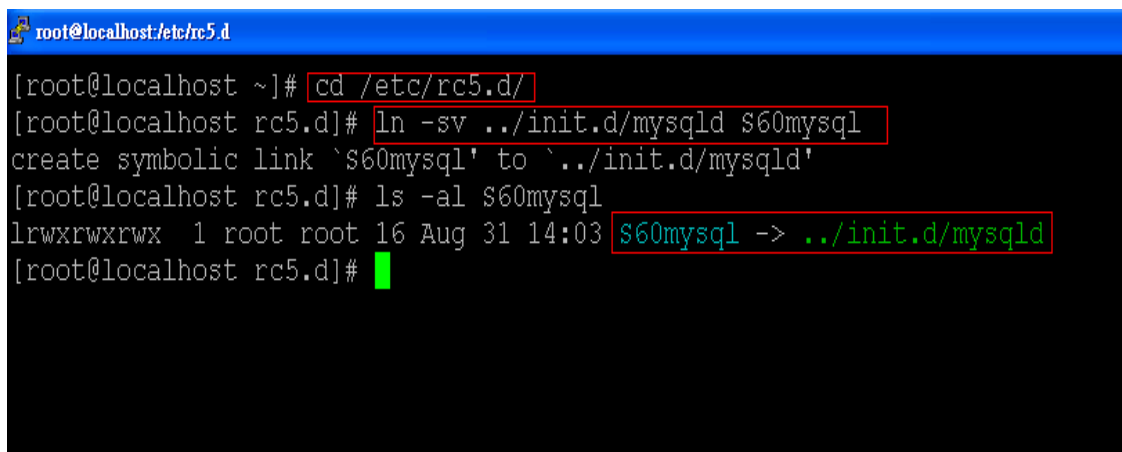

```
root@localhost:/etc/rc5.d
[root@localhost ~]# cd /etc/rc5.d/
[root@localhost rc5.d]# ln -sv ../init.d/mysqld $60mysql
create symbolic link `'$60mysql'` to `../init.d/mysqld'
[root@localhost rc5.d]# ls -al $60mysql
lrwxrwxrwx 1 root root 16 Aug 31 14:03 $60mysql -> ../init.d/mysqld
[root@localhost rc5.d]#
```

Fig 9-11

## (2) Support PHP

PHP is a kind of “ open source script language “ and used to design active web page. When PHP combined with MySQL are cross-platform. It means that users can develop in Windows and serve on a Linux platform. (Refer to Fig 9-12)

PHP has been built in the LP-8X81 Series Kernel so users just boot up LP-8X81 Series and can use PHP directly in the LP-8X81 Series.

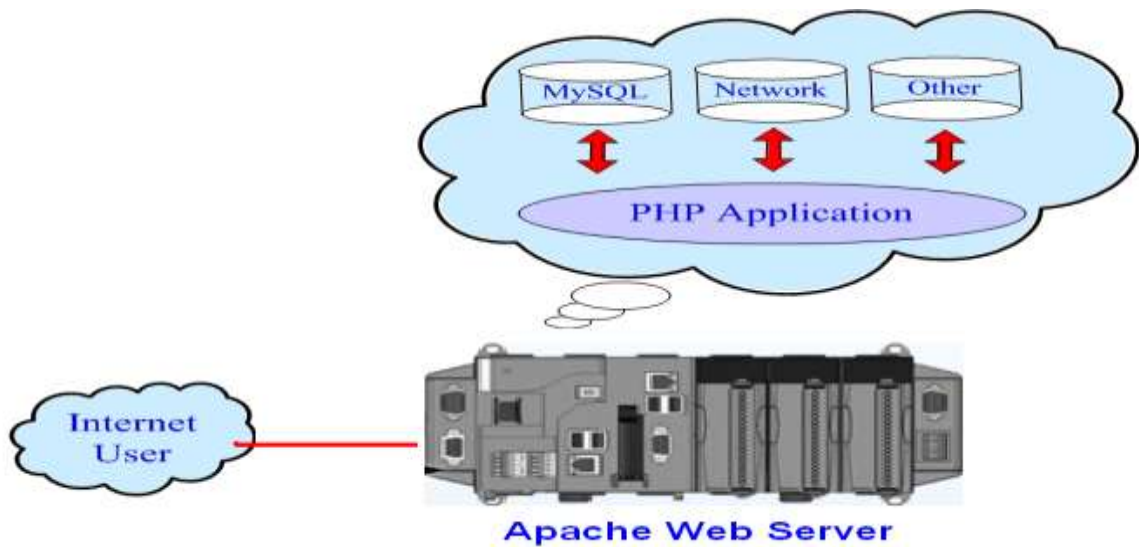

Fig 9-12

### (3) Support Perl

Perl ( Practical Extraction and Report Language ) is also an “ open source script language “ and has been built in the LP-8X81 Series Kernel so users just boot up LP-8X81 Series and can use Perl directly in the LP-8X81 Series.

### (4) Support GCC

GCC ( GNU Compiler Collection ) is a compiler system produced by the GNU Project supporting various programming languages. The GCC has been built in the LP-8X81 Series system so users can use GCC to compiler the software directly in the LP-8X81 Series.

---

## Appendix A. Service Information

---

This appendix will show how to contact ICP DAS when you have problems in the LP-8X81 Series or other products.

### Internet Service :

The [internet service](#) provided by ICP DAS will be satisfied and it includes [Technical Support](#), [Driver Update](#), [OS\\_Image](#), [LinPAC\\_SDK](#) and [User's Manual Download](#) etc. Users can refer to the following web site to get more information:

1. ICP DAS Web Site : <http://www.icpdas.com/>
2. Software Download : <http://ftp.icpdas.com/pub/cd/linpac/napdos/lp-8x8x/atom>
3. E-mail for Technical Support : [service@icpdas.com](mailto:service@icpdas.com)

## Manual Revision:

Manual Edition	Revision Date	Revision Details
V 1.0	2011. 9.30	1. The first version of user manual.
V 2.0	2015/4/29	1. Add section “9.2 N-Port Module (i-8114w or other serial modules) Support” to indicate every port number and corresponding device file name.
V 3.0	2015/5/25	1. Combine manual “ <b>LinPAC-8x81_User_Manual.pdf</b> ” and “ <b>LinPAC-8x81-Atom_User_Manual.pdf</b> ” 2. Add section “4.4 System Language”. 3. Add section “Upgrade OS to new version by CF card (LinPAC-8X81 only)”
V 3.1	2016/6/17	1. Add section “4.8 Set up OS filesystem check (fsck) at boot time”
V 3.2	2016/6/24	1. Rewrite section “Upgrade OS to new version by CF card (LinPAC-8X81 only)” content, and renamed “Make a new CF card to recover LP-8x81 Series OS” 2. Fix section 4.2.1 content.