

USB-87P1/2/4/8

User Manual

Version 1.3

May , 2015

Original Writer: Martin Hsu

Last Writer: Hans Chen



Table of Contents

Chapter 1	Introduction	4
1.1	Specifications	7
Chapter 2	Hardware Configuration.....	8
2.1	Install USB Driver	8
2.2	View of the USB-87PN	13
2.2.1	Preparation	13
2.2.2	Wire the 87Pn to power and PC	14
2.2.3	USB-87Pn's CPU module:.....	14
2.2.4	USB-87Pn series CPU Module Description	15
2.2.5	Plug in the I/O modules:	15
2.2.6	Wiring the I/O modules:.....	16
2.2.7	Installing USB-87Pn extension unit	18
Chapter 3	Software Configuration.....	19
3.1	Setup USB-87Pn with DCON Utility	19
3.1.1	87Pn Auto Config. Enable:	21
3.1.2	87Pn Auto Config. Disable:.....	23
3.2	Save & Load 87Pn Configure file	23
3.2.1	Save the Configure file:	24
3.2.2	Load the Configure file	25
3.3	Load & Write the configure file	27
3.4	Operating in off-line mode:	28
Chapter 4	Software Development Kits (SDK)	33
4.1	PACSDK.....	34
4.2	DCON LabVIEW.....	35
4.2.1	Procedure for using DCON_LabVIEW.....	35
4.2.2	LabVIEW Example (Reading multi-channel analog Input value).....	36
4.2.3	LabVIEW Demo Program (Reading multi-channel analog input value).....	38
4.3	DCON InduSoft	39
4.3.1	Procedure for using the InduSoft bundled driver.....	39
4.3.2	InduSoft Example (Reading an analog input value).....	39
4.4	NAP OPC Server.....	43
4.4.1	Procedure for using the OPC Server	43
4.4.2	OPC Server Example (Reading an analog input value).....	43
Appendix A	: Dimension.....	45
Appendix B	: Compare USB-87Pn with I-87Kn.....	49
Appendix C	: Solution for 87K I/O module on the slot.....	50
Appendix D	: Description For ini Files.....	55
Appendix E	: Frame Ground	56

FIGURE

Fig.1 : View of 87Pn	13
Fig.2 : Wire the 87Pn to power and PC	14
Fig.3 : 87Pn's CPU Module	14
Fig.4 : USB-87P1/2/4/8 CPU module description	15
Fig. 5 : Plug in the I/O module	15
Fig. 6 : Description of LED indicator	16
Fig. 7 : I-87019R - Internal I/O structure	16
Fig. 8 : I-87019R - Pin assignments & Wire Connection	17
Fig.9 : I/O module terminal connection	17
Fig.10 : Installing USB-87Pn extension unit	18
Fig. 11 : Run Dcon Utility and search 87Pn	19
Fig.12 : Auto Config. Enable, setup the 87Pn	21
Fig.13 : Follow 3 steps, write the settings to 87Pn	21
Fig.14 : Complete the 87Pn configuration then serch again	22
Fig.15 : After configuring, you can find out the entire module	22
Fig. 16 : When 87Pn Auto Config.: Disable, all the module can external communication	23
Fig. 17 : Save the configuration file	24
Fig. 18 : Load the configuration file	25
Fig. 19 : Load & Write the configuration file	27
Fig. 20 : Configure and save file in off-line mode	28
Fig. 21 : Load & write Configuration file through other PC	29
Fig. 22 : Off-line operation	29
Fig. 23 : Off-line operation – Configure & Save file	30
Fig. 24 : Load configure file in another PC	31
Fig. 25 : Write the settings to USB-87Pn	32
Fig. 26 : I-87K high/low profile series I/O modules	49
Fig. 27 : The search result between 87Pn and modules	50
Fig. 28 : DCON Utility shows the status of 87Pn expansion slot	50
Fig. 29 : Frame Ground & Earth Ground	56

Chapter 1 Introduction

USB-87Pn series is a intelligent I/O expansion unit, it features USB communication interface, hot swap, and most of all, this I/O unit can expand its functions by putting in any kind of I-87K series (High profile) modules. It used for industrial monitoring and controlling applications. There are more than 30 I/O modules supported with the unit, including analog input/output, digital input/output, and counter/frequency I/O modules.

USB-87Pn is designed to be used in harsh and noisy environment, so the hardware is manufactured with wide power input range (10~30VDC) and operating temperature (-25°C ~ +75°C). It simplifies installation and maintenance of I/O modules with hot swap and auto configuration, fault and error detection, dual watchdog, programmable power on and Safe Values.

Various software development kits (SDK) and demos are provided, such as DLL, ActiveX, LabVIEW driver, InduSoft driver, Linux driver, OPC Server, etc. The I-87K series I/O modules plugged in the USB-87Pn can be easily integrated into variant software system.

Features

► Hot Swap

The USB-87Pn doesn't need to shut down its power to replace or plug I-87K I/O modules. Therefore, the whole system can keep operating without any interruption.

► Auto-Configuration

Configurations of I-87K I/O modules can be pre configured and stored in the nonvolatile memory of the USB-87Pn. When the USB-87Pn is power on or an I-87K I/O module is plug in, the USB-87Pn automatically check and restore these configurations to each I-87K I/O modules on it.

► Easy Duplicate System

Using the DCON Utility, you can easily make a backup of the I-87K module configurations and write to another USB-87Pn. This design can easily and quickly duplicate many USB-87Pn.

► Easy Maintenance and Diagnostic

The basic configurations (Auto Config, ON/OFF) are set by the DIP switch. The operator can use only one screwdriver to set the USB-87Pn. And there are several LED status indicators to show whether I-87K modules are configured and work properly.

If one I-87K module is damage, the user just need to get the same model number and

good I-87K module to replace the damaged one. And then check the LED indicators to know whether the replacement is performed correctly. The switch and LED design makes it easy for maintenance. There is no PC and Notebook needed.

► Communication

■ USB interface

The USB-87Pn use USB communication interface. It requires no converter, plug and play at run time, very simple and convenient to connect with your PC .

■ DCON protocol

I-87K series I/O modules plugged in a USB-87Pn provide a simple command/response protocol (Called DCON protocol) for communication. All command/response are in easy used ASCII format.

► Rugged Industrial Environment

■ Dual watchdog design

The I-87K series I/O modules provides module watchdog and host watchdog. The module watchdog is a hardware watchdog; the host watchdog is a software watchdog. The module watchdog is designed to automatically reset the microprocessor when the module hangs. The host watchdog monitors the host controller (PC or PLC). The output of module can go to the Safe Value state when the host fails.

■ Programmable power on and Safe Value

The analog and digital output of modules can be programmed power on and Safe Value.

■ Wide range power input (10~30 VDC)

Wide range operating temperature (-25 °C ~ +75 °C)

► Fully Software Support

The free charge software utility and development kits include

■ DCON Utility: for configuration

Module	Address	Baudrate	Checksum	Format	Status	Description
USB-87P4	1[1]	115200	Disable	N,8,1	Auto Config. Enable [0,0,0,0]	4*Slot Auto Configuration USB Unit(DCON)
--87019H	2[2]	115200	Disable	N,8,1	87P4 Slot[0]	8°AI (Universal mA,mV,V,Thermocouple)(DCON)
--87018R	3[3]	115200	Disable	N,8,1	87P4 Slot[1]	8°AI (mA,mV,V,Thermocouple)(DCON)
--87024	4[4]	115200	Disable	N,8,1	87P4 Slot[2]	4°AO (mA,V)(DCON)
--87055	5[5]	115200	Disable	N,8,1	87P4 Slot[3]	8°DI + 8°DO(DCON)

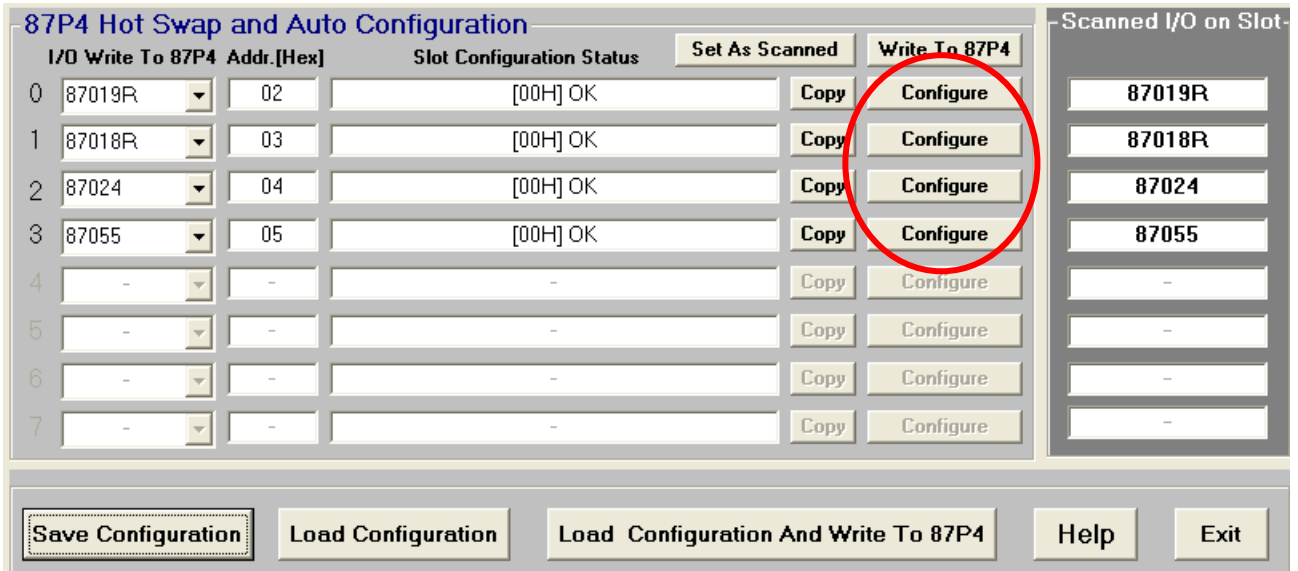

■ **OPC Servers:**

OPC is an industrial standard interface based on OLE technology. With the OPC Server, I/O modules can be easily integrated to any software that has OPC client capability.

■ **EZ Data Logger**

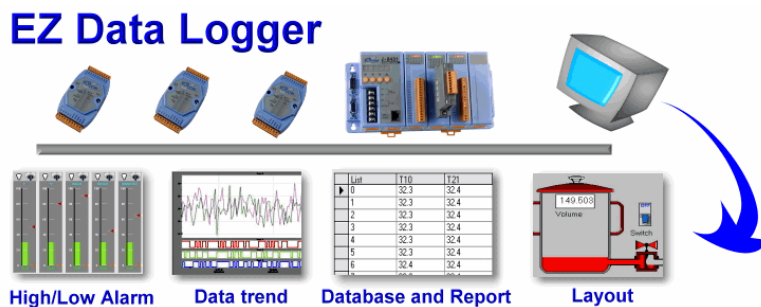

EZ Data Logger is small data logger software. It can be applied to small Remote I/O system. With its user-friendly interface, users can quickly and easily build a data logger software without any programming skill.

■ **Support Variant Software Develop Toolkits**

The free charge for DLL, ActiveX, LabVIEW driver, InduSoft driver, DasyLab driver, Linux driver.

1.1 Specifications

■ Interface Type :Full speed with USB 1.1 specifications		
Cable	USB type A connector	
Baud rate	115200 bps (default fixed)	
Isolation	3000 VDC	
ESD Protection	+/- 4K Contact Discharge and +/- 8K Air Discharge	
■ Switch		
DIP Switch	1 bit *1, For auto configuration	
■ LED Indicators		
Power	Yes	
System Ready	Yes	
Auto-Configuration	Yes	
Slot Status	Yes	
■ I/O Expansion Slots		
Hot Swap	Yes	
Auto-Configuration	Yes	
Support Module Type	High profile I-87K module only	
<i>Dimensions (W x H x D)</i>		
USB-87P1 (slot x 1)	64mm x 117mm x 110mm	
USB-87P2 (slot x 2)	95mm x 132mm x 111mm	
USB-87P4 (slot x 4)	188mm x 132mm x 111mm	
USB-87P8 (slot x 8)	312mm x 132mm x 111mm	
■ Power		
Input Range	10~30 VDC (non-regulated)	
Reverse polarity protection	Yes	
Isolation	1000 VDC	
Frame Ground	Yes	
Module	<i>Consumption</i>	<i>Power Board Driving</i>
USB-87P1	1 W	5 W
USB-87P2	1 W	8 W
USB-87P4	2 W	15 W
USB-87P8	2.4 W	30 W
■ Environment		
Operating Temperature	-25°C to +75°C	
Storage Temperature	-30°C to +75°C	
Humidity	5 ~ 95%, non-condensing	

Chapter 2 Hardware Configuration

2.1 Install USB Driver

Before you setup the USB-87Pn, you must install USB driver. Refer to below path:

CD:\Napdos\87pn_io_unit\USB-87Pn

ftp://ftp.icpdas.com/pub/cd/8000cd/napdos/87pn_io_unit/usb-87pn/

Note: The old version of USB-87Pn with old USB chip needs to install old USB driver, it is located at CD:\Napdos\87pn_io_unit\USB-87Pn\old

ftp://ftp.icpdas.com/pub/cd/8000cd/napdos/87pn_io_unit/usb-87pn/old/

Step1: Double click “USB-87Pn DriverInstaller.exe” to enter the installation screen



Step2: Click “Next >” to next step

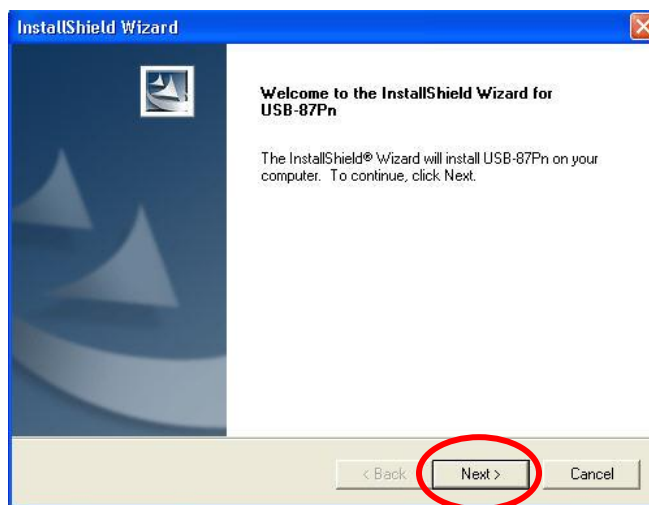

Step3: Reading the license. If you accepted all of the license items, please click “Yes” to next step.



Step4: In the next screen, please click “Continue Anyway” to continue the Installation.

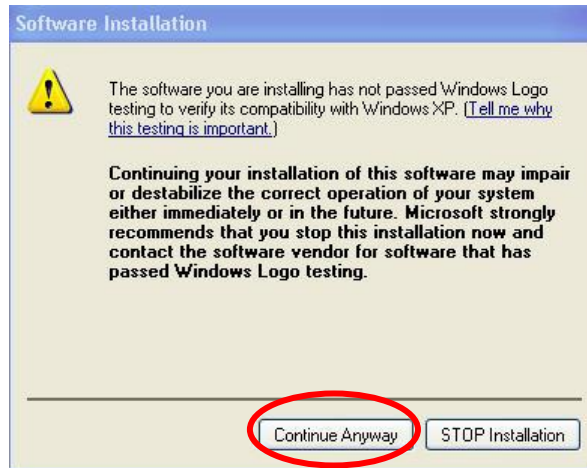

Step5: In this screen, you already finished the installation, please click “Finish” to exit the program.

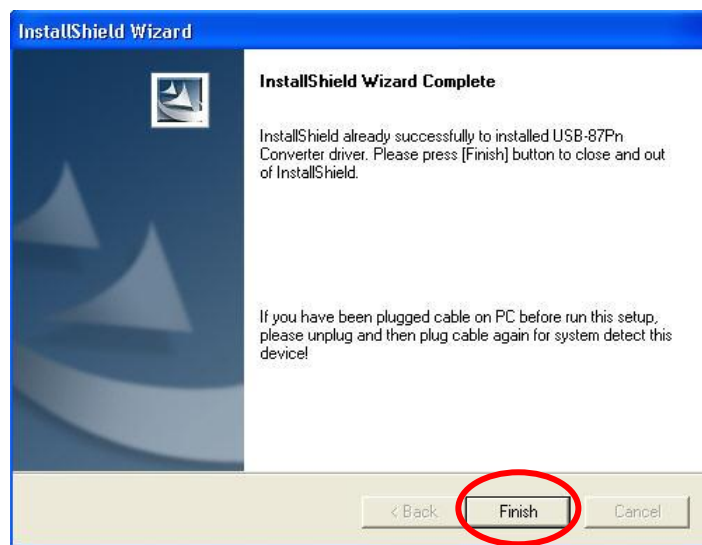

Step6: Please check the driver installation in your PC’s “Device Manager” screen.

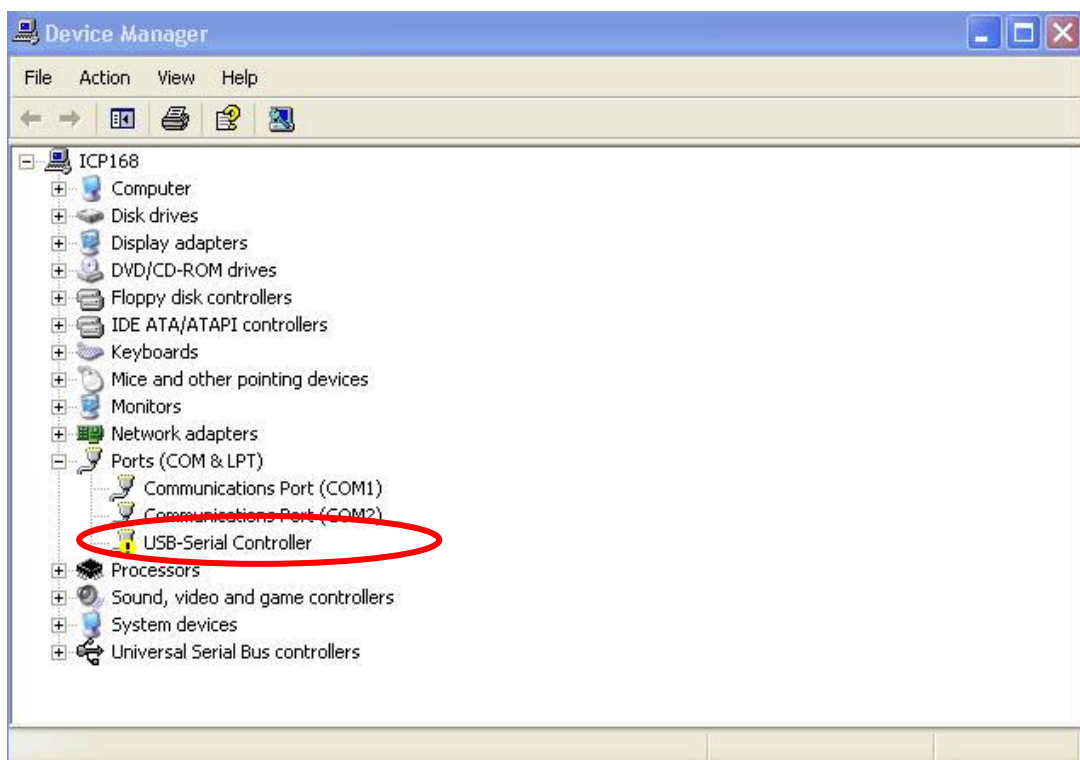

Step7: When you connect the USB-87Pn to your PC, It will show following diagram, please Select “Install from a list or specific location (Advanced)” then click “Next>”.



Step8: Without any change, Click “Next>” to next step

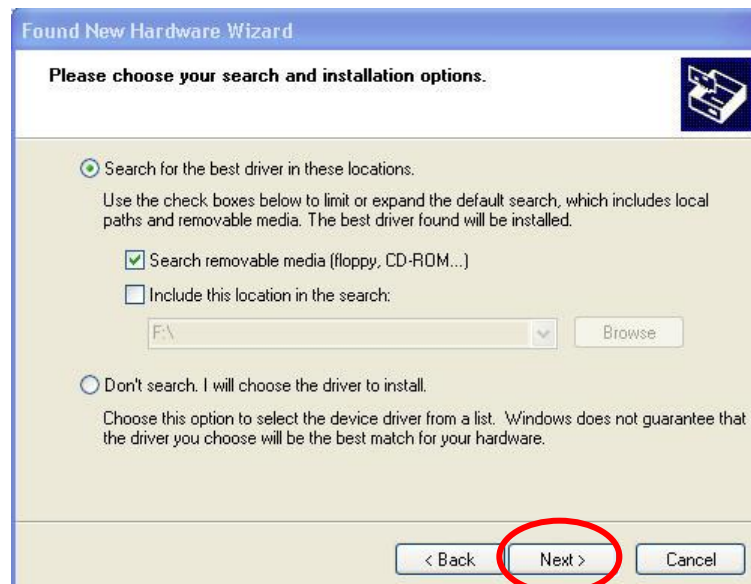

Step9: please click “Continue Anyway” to continue the Installation.

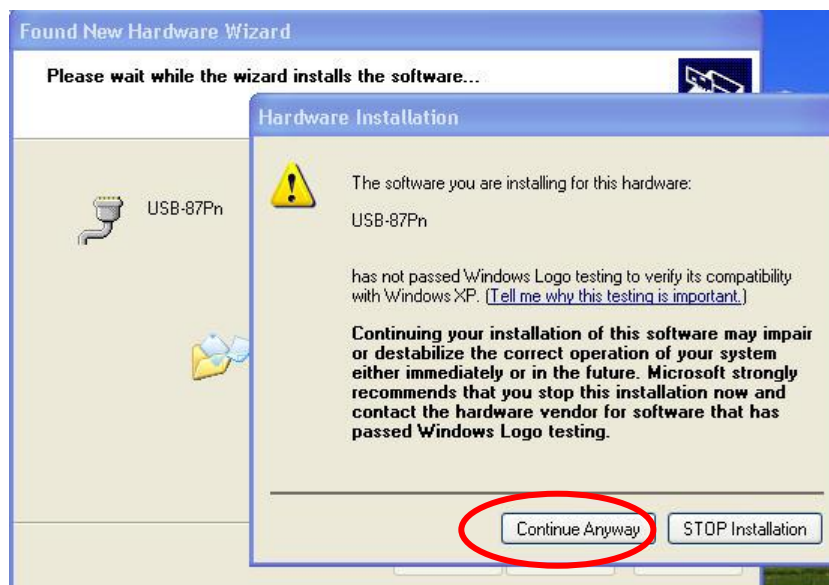

Step10: In this screen, you already finished the installation, please click “Finish” to exit the program.



Step10: Please confirm the installation of USB-87Pn and to know which port is connected.

Click the right button on “My Computer” icon → property → Hardware → Add Hardware Wizard → Device Manager



Note: The old version of USB-87Pn with old USB chip show as below:

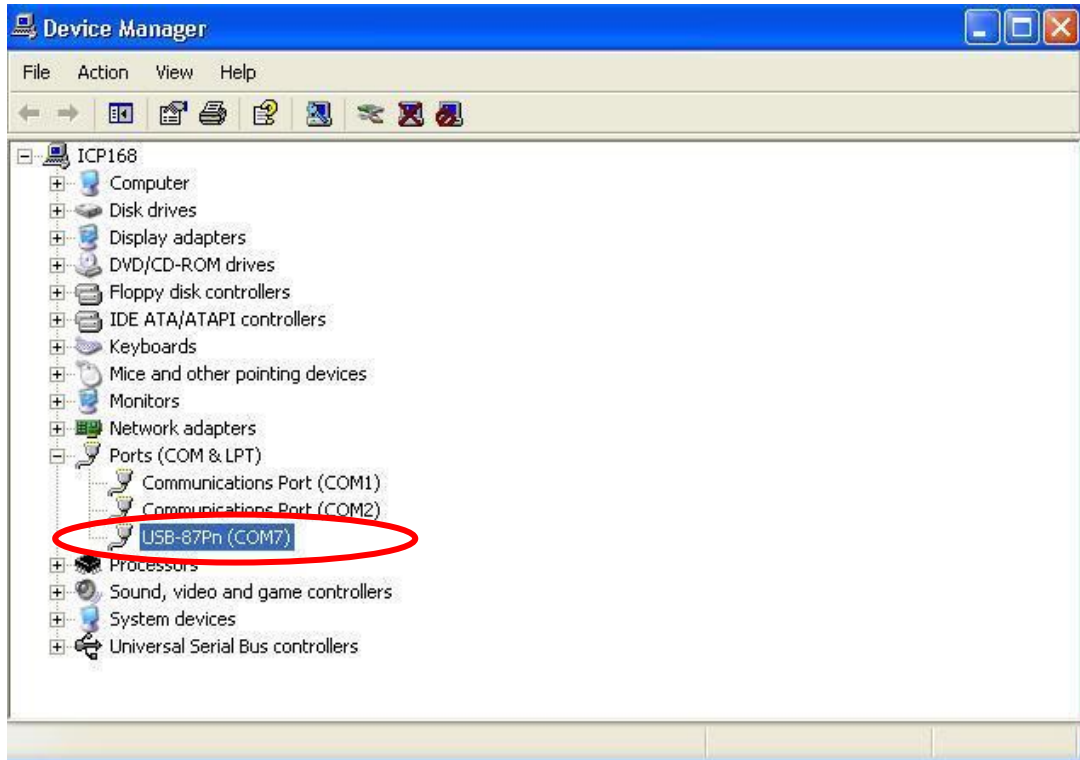

2.2 View of the USB-87PN

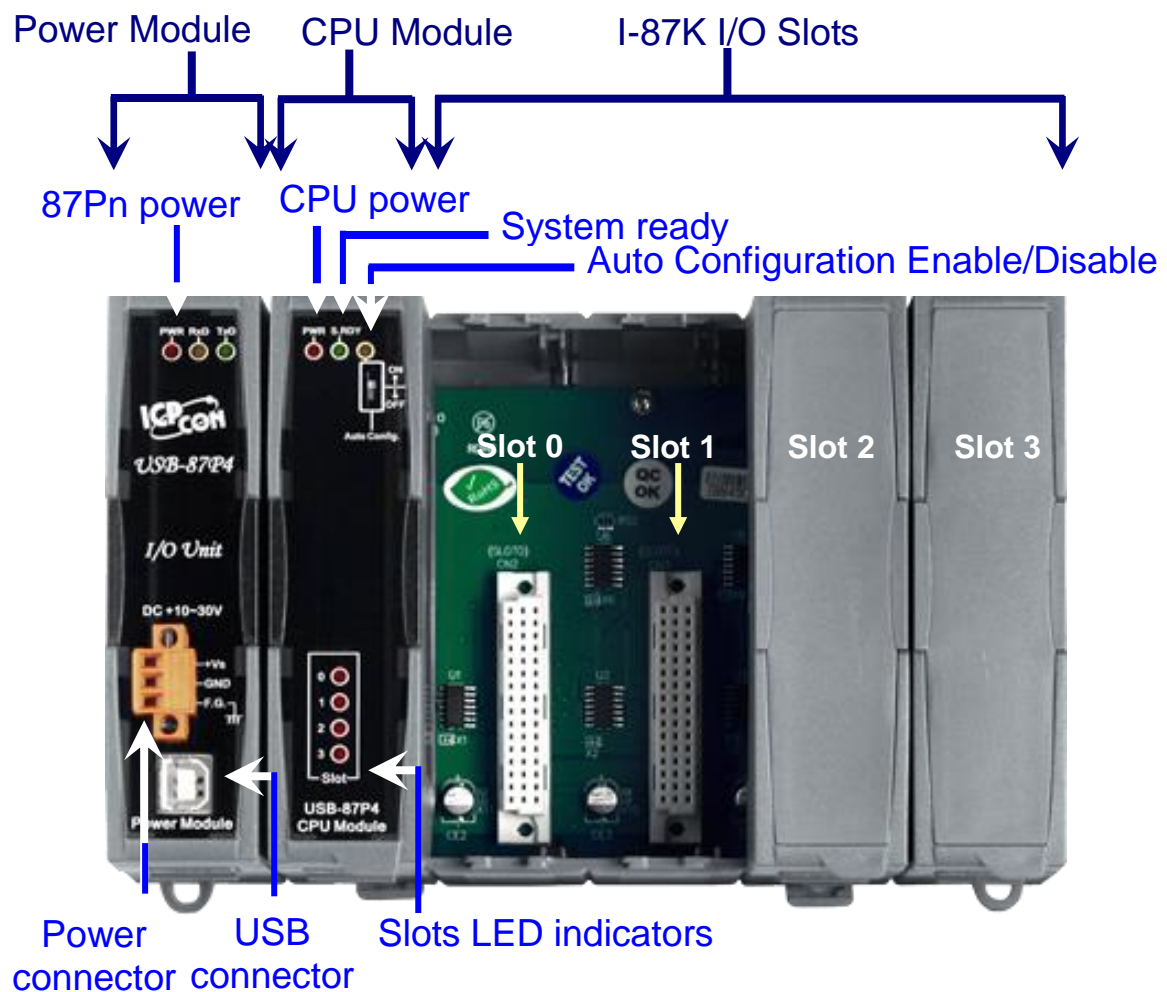

Fig.1 : View of 87Pn

2.2.1 Preparation

- ▶ Power Supply: +10V ~ +30V /DC (Ex: DP-665)
http://www.icpdas.com/products/Accessories/power_supply/power_list.htm
- ▶ CA-USB18: USB connector cable (1.8M Cable)
http://www.icpdas.com/products/Accessories/cable/cable_selection.htm
- ▶ Install the DCON Utility to PC (Version 4.5.2 or above version)
CD:\Napdos\Driver\DCON_Utility or
ftp://ftp.icpdas.com/pub/cd/8000cd/napdos/driver/dcon_utility/
(Please removed the old version before installation)

2.2.2 Wire the 87Pn to power and PC

USB-87P4

1. +Vs ⇔ Power Supply : +Vs (+10~30V)
2. GND ⇔ Power Supply : GND
3. CA-USB18 ⇔ PC's USB port

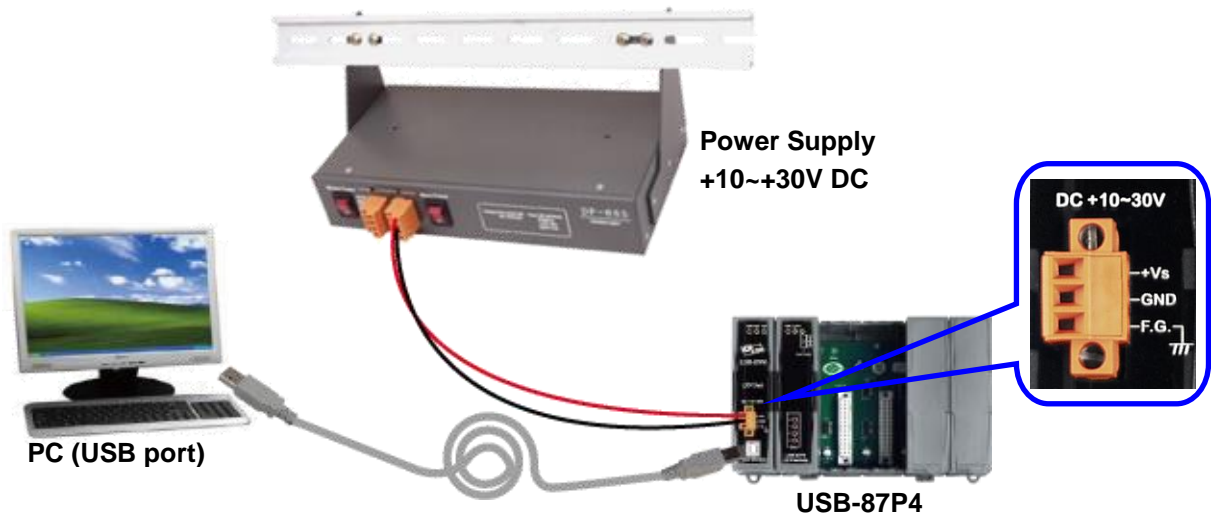

Fig.2 : Wire the 87Pn to power and PC

2.2.3 USB-87Pn's CPU module:

The factory default value is Auto Config. ON.

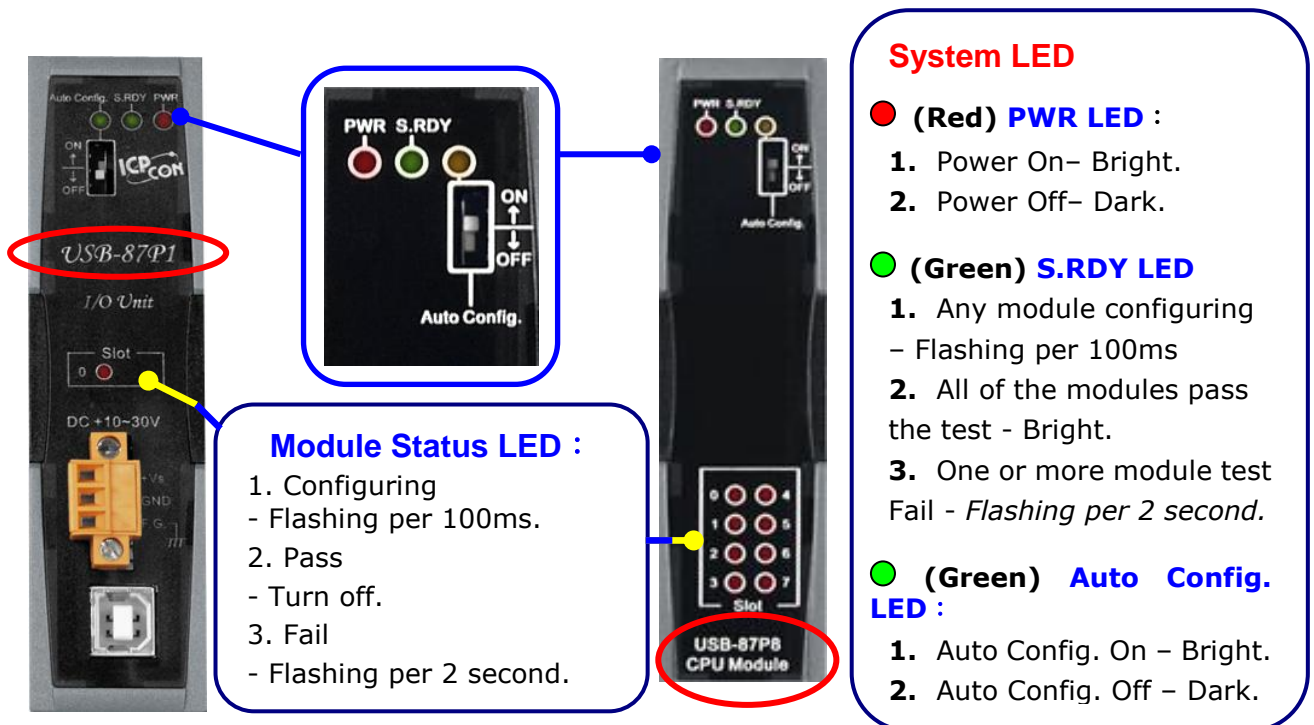

Fig.3 : 87Pn's CPU Module

2.2.4 USB-87Pn series CPU Module Description

Check the left side of the Power Board for the CPU module LED and Dip Switch description.

Default Setting					
Address	Baud Rate	Parity	Data Length	Stop bit	Checksum
01	115,200	None	8	1	Disable

USB-87P series CPU Board Description					
LED	Description	ON	OFF	Flashing (100ms)	Flashing (2sec)
S.RDY	System Ready	Ready	/	Configuring	Failure
Auto Config	Auto Configuration	Enable	Disable	/	/
Slot	Slot Status	/	Normal	Configuring	Failure



Fig.4 : USB-87P1/2/4/8 CPU module description

2.2.5 Plug in the I/O modules:

At present, ICPDAS divides most of the same I-87K I/O module into the Low Profile and High Profile two kinds of version, **if you want to use the module on 87Pn expansion slot, you must choose the High Profile** to assure “Auto Config.” and “Hot Swap” function is normal operation.

The related product information about I-87K I/O module is in the CD. You can refer I-87K High Profile series I/O modules in following path:

CD:\Napdos\DCON\IO_Module\87k_modules.htm or to following web-site

ftp://ftp.icpdas.com/pub/cd/8000cd/napdos/dcon/io_module/87k_modules.htm

Example: Plug in I-87019R to Slot 0

p.s. I-87019R is an AI (Analog Input) High Profile module

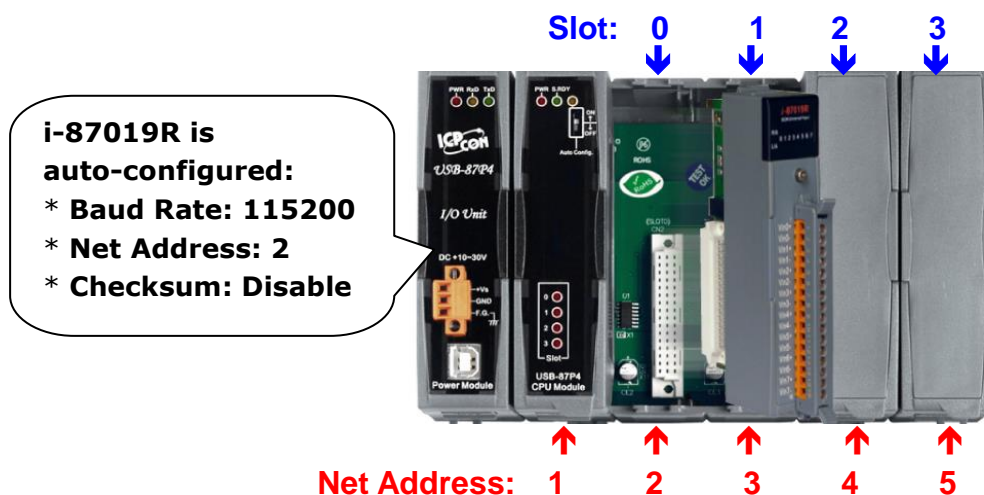

Fig. 5 : Plug in the I/O module

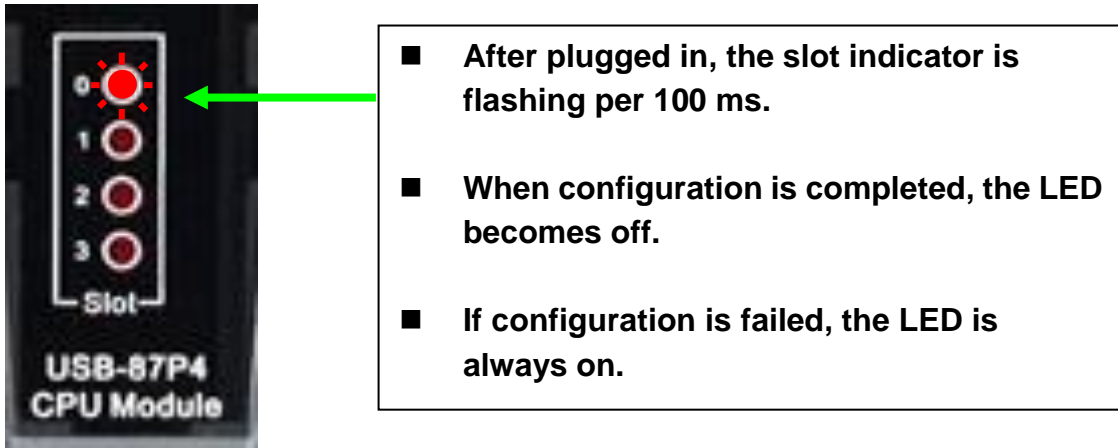

Fig. 6 : Description of LED indicator

2.2.6 Wiring the I/O modules:

Before wiring the I-87K I/O modules, please check the pin assignment and wiring according to each hardware user manual.

For each I-87K I/O module's hardware user manual please refer to CD:\Napdos\DCON\IO Module\87k_modules.htm

According to the internal circuitry diagram and wire connection diagram, please connect the power cable or communication cable to each channel on terminal block of I/O module.

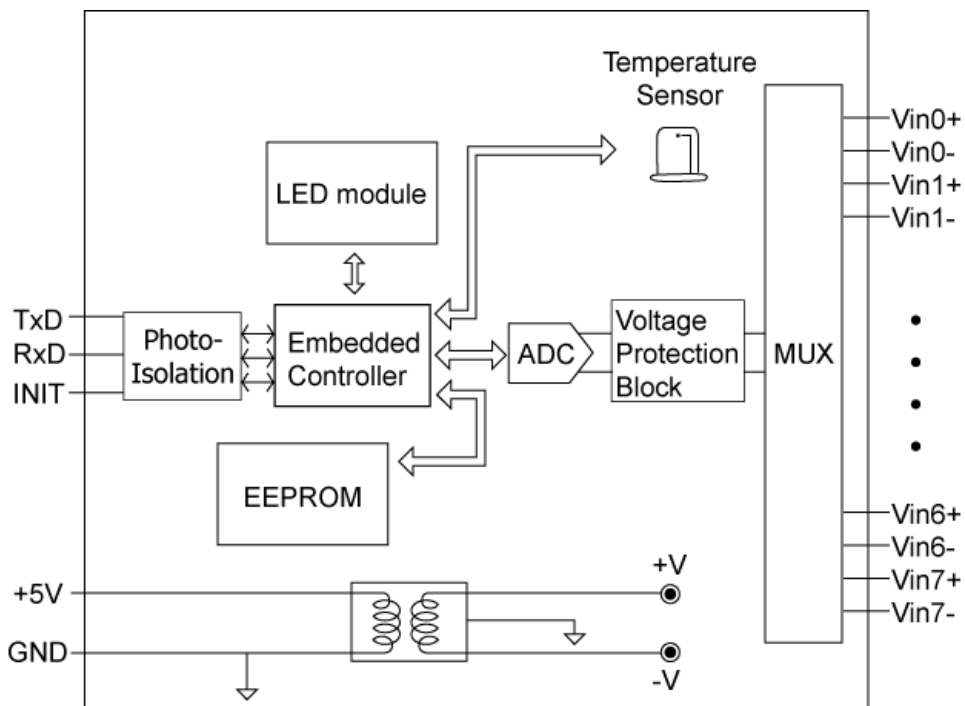

Fig. 7 : I-87019R - Internal I/O structure

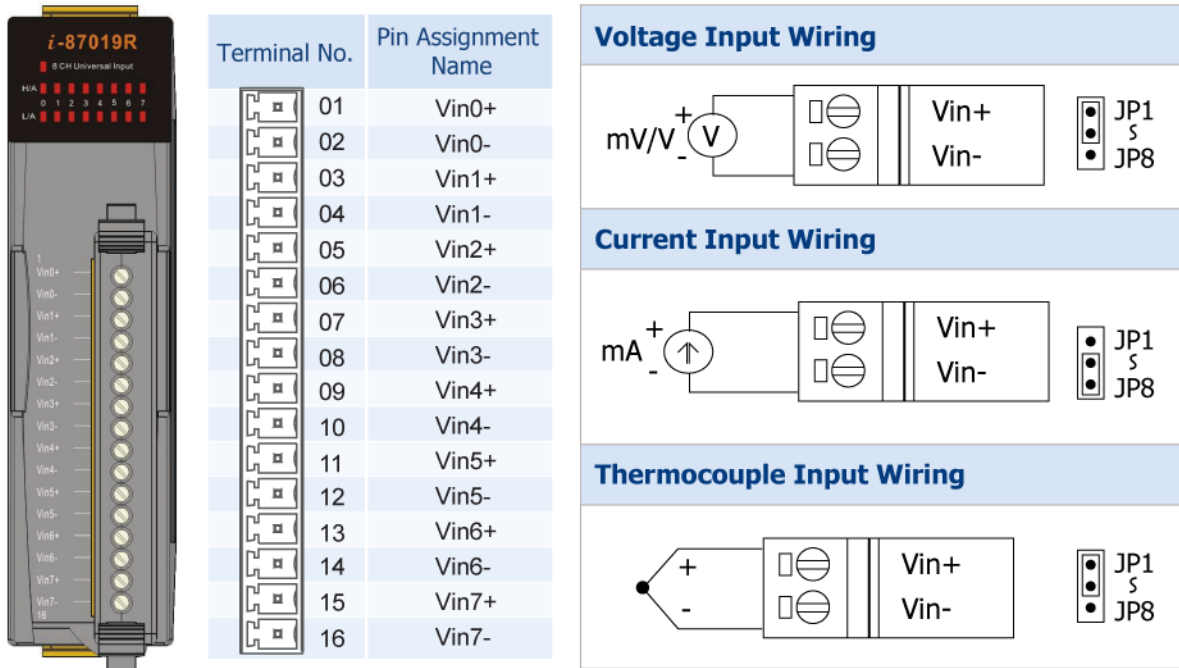

Fig. 8 : I-87019R - Pin assignments & Wire Connection

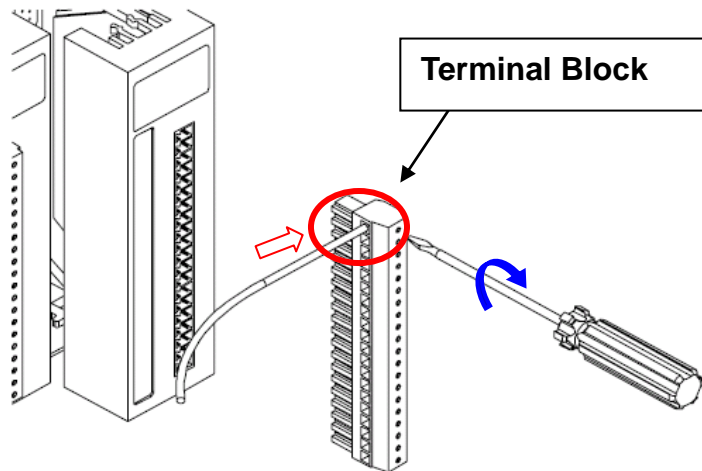
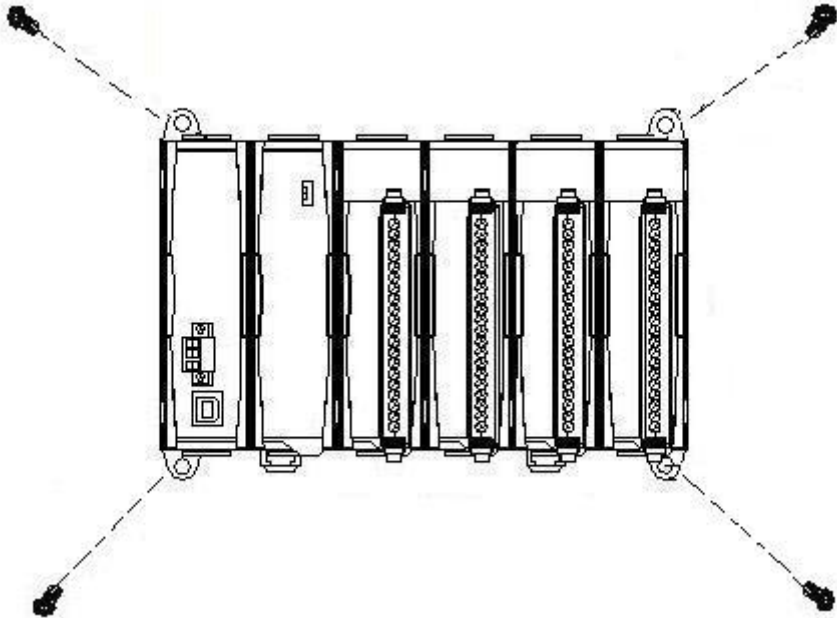

Fig.9 : I/O module terminal connection

2.2.7 Installing USB-87Pn extension unit

Method 1: using the screw to fixed.



Method 2: using the DIN rail clips to fixed.

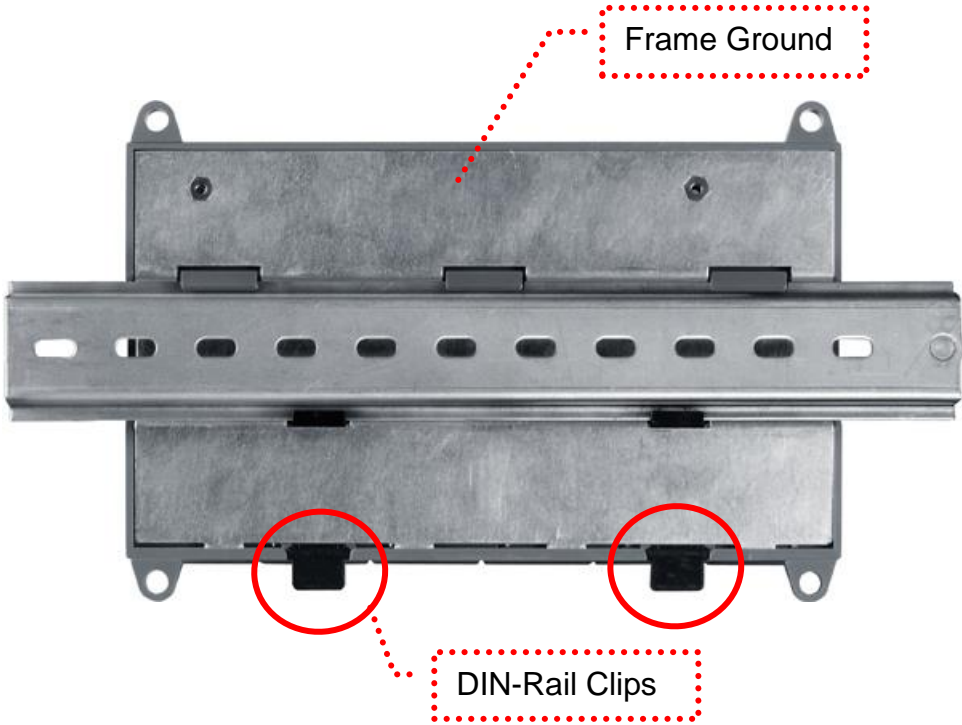

Fig.10 : Installing USB-87Pn extension unit

Chapter 3 Software Configuration

In this chapter, we will use DCON Utility to complete software configuration of the USB-87Pn, please confirm the hardware equipment has connected and 87Pn CPU module has setup completes. (Please refer to [Chapter 2](#))

- 3.1 [Setup USB-87Pn with DCON Utility](#)
- 3.2 [Save & Load 87Pn configure file](#)
- 3.3 [Load & Write configure file](#)
- 3.4 [Operating in off-line mode](#)

3.1 Setup USB-87Pn with DCON Utility

At first, please run DCON Utility then click “COM Port” to select COM Port and baud rate. You can check your PC’s “Device Manager” to know which COM is connecting. Click “OK” to confirm and escape the screen.

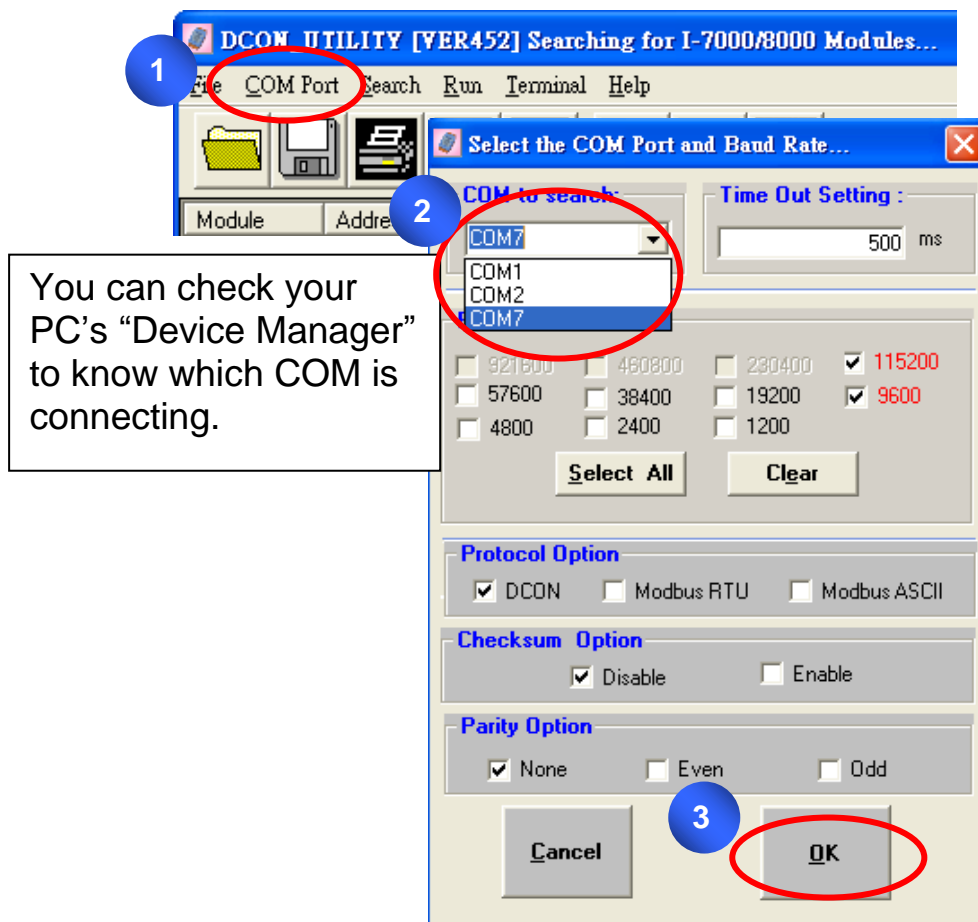
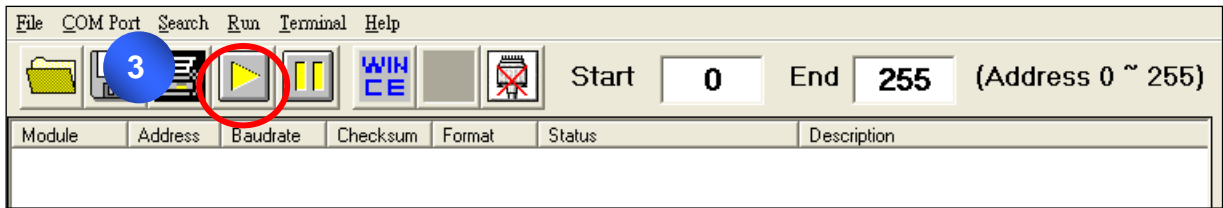

Fig. 11 : Run Dcon Utility and search 87Pn

Please click “start search” button to search.



At the first time you can search for “USB-87Pn” only, because the slots of USB-87Pn haven’t completed the configuration. The “[X,X,X,X]” of “Status” means the configuration of that slot is not completed or corrected.

Please click “stop search” to stop the search.

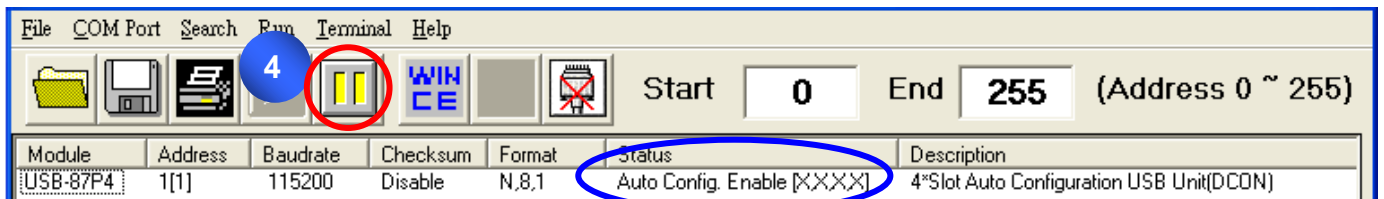

When found USB-87Pn, click  to stop search. “[X,X,X,X]” of “Status” means the configuration of that slot is not completed or corrected.

Click “USB-87Pn” and open the “Configure Module” screen to setup.

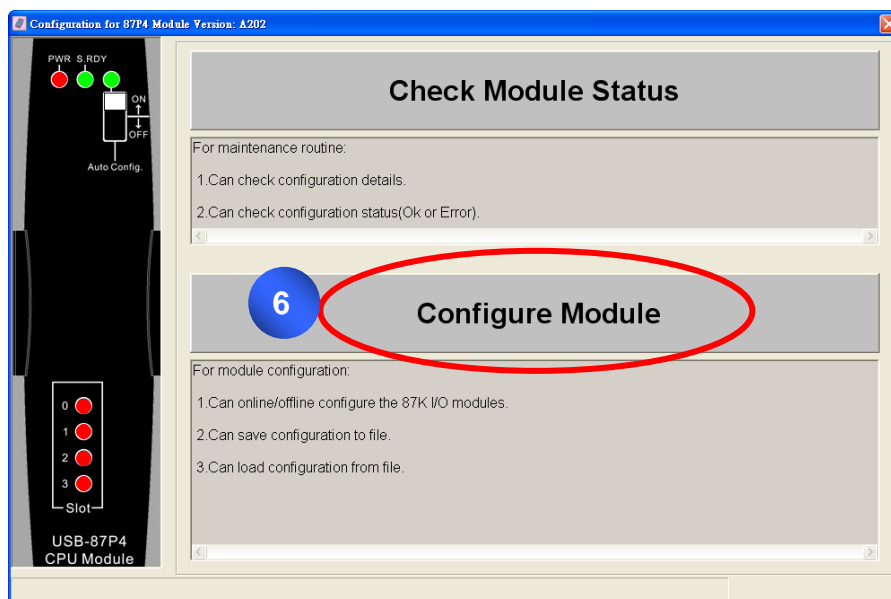
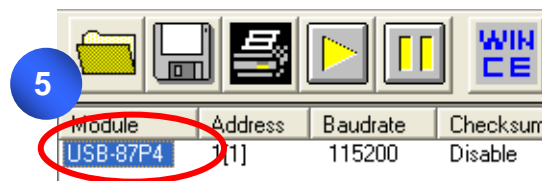

3.1.1 87Pn Auto Config. Enable:

"Auto Config. ON" expressed that the 87Pn's Auto-Configuration function is "enable", "off" means "disable".

Working Distinction:

If I-87K I/O modules didn't pass the 87Pn correct setup, and install into expansion slot under "Auto Config. Enable" mode, it will regard as incorrect module. For guarantee system's normal operation, the 87Pn will forbid this module external communication. You can't search and configure I/O modules directly by DCON Utility.

The "Auto Config. Enable [X,X,X,X]" in Status column, means the module configuration of that slot is not completed or corrected. Click "USB-87P4" and select "Configure Module" to enter configure screen and know the detail settings about module.

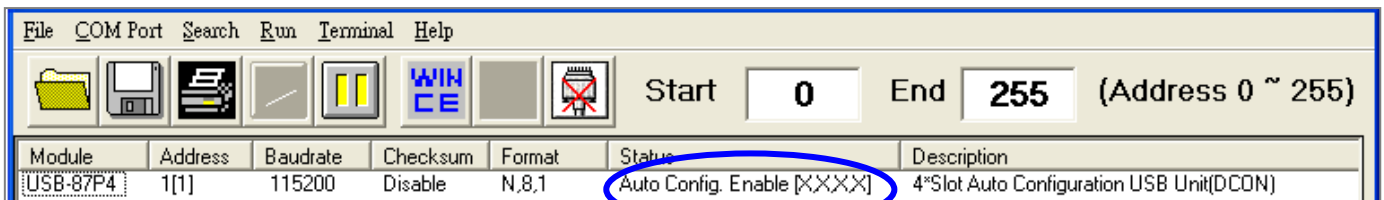

Fig.12 : Auto Config. Enable, setup the 87Pn

In 87Pn configure screen, you can see the scanned module name in "Scanned I/O on Slot" column. Click "Set As Scanned" button to assign module name and click "configure" to setup the I/O module according to the user demand. Finally click "write to 87Pn" for the settings to take effect.

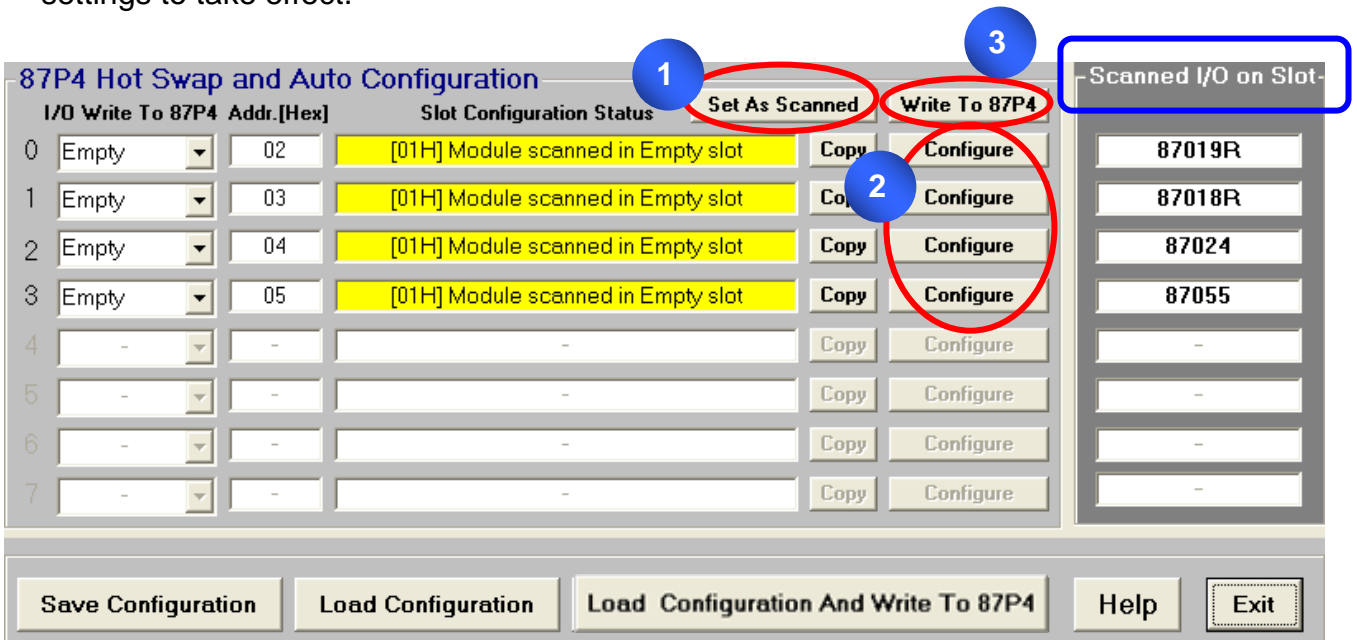

Fig.13 : Follow 3 steps, write the settings to 87Pn

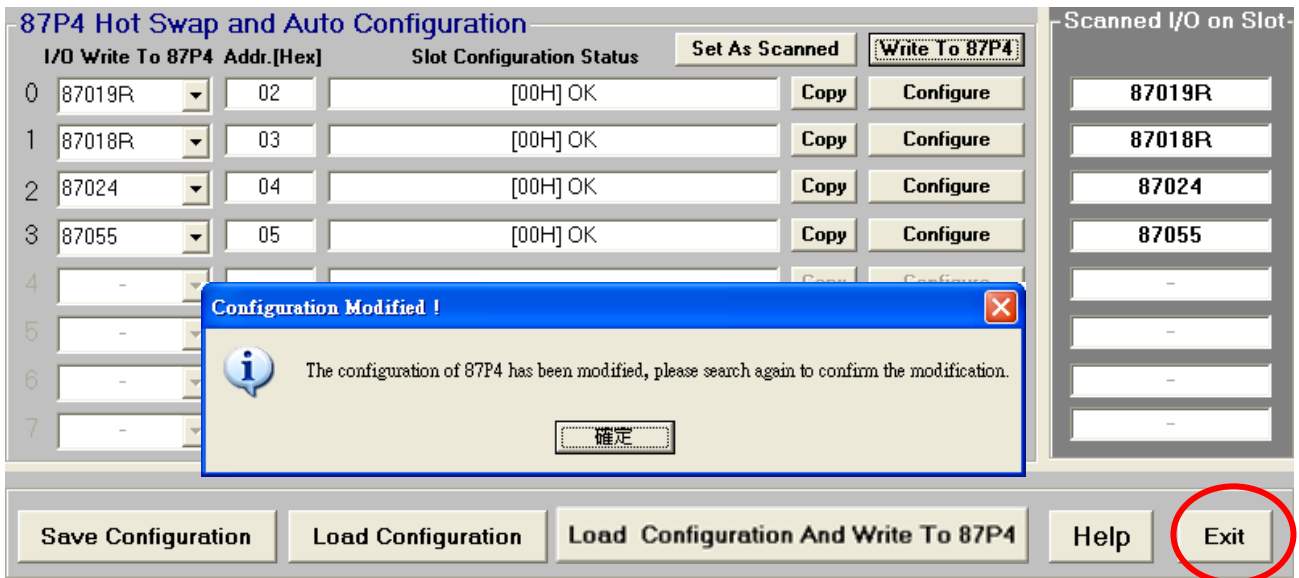

Fig.14 : Complete the 87Pn configuration then search again

As above, all the settings for each modules has configured correctly by "DCON Utility", and then search the module again, you can see each plugged I/O module name will be listed under the screen.

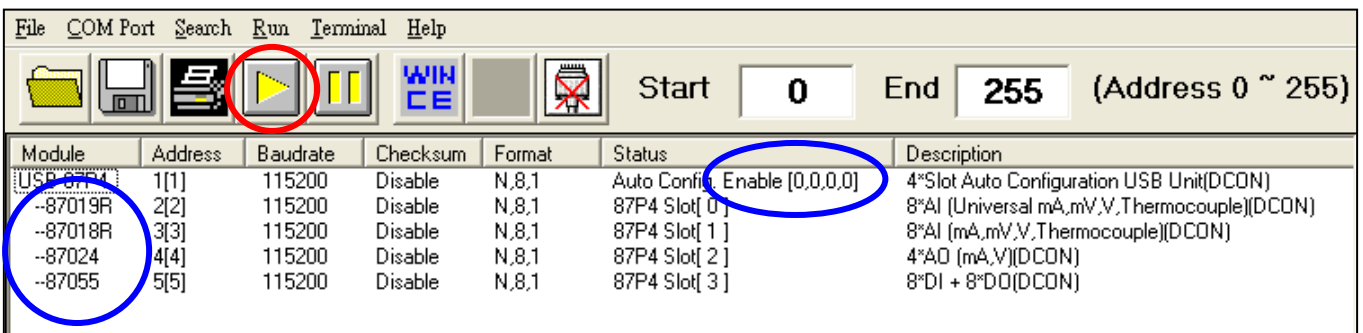
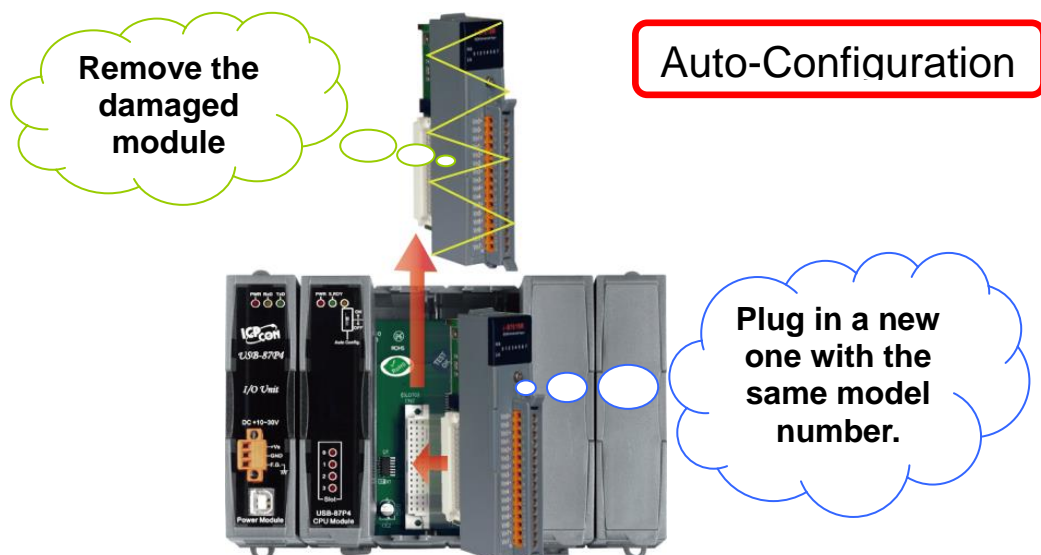

Fig.15 : After configuring, you can find out the entire module

The "Auto Config. Enable [0,0,0,0]" of "Status", means "The I/O configuration of each slot is correct. If module is damaged, you don't need to shutdown the power, just remove the damaged one and install the same model number of new module. 87Pn will write the previous settings to the module automatically.



3.1.2 87Pn Auto Config. Disable:

Working Distinction:

In 87Pn Auto Config. Disable mode; allow the I-87K I/O modules to external communications even you haven't completed the configuration. Therefore, when you perform searching by DCON Utility, you could find 87Pn CPU module as well as 87K I/O modules on the expansion slot. But you can't click "USB-87P4" to setup the modules in this mode.

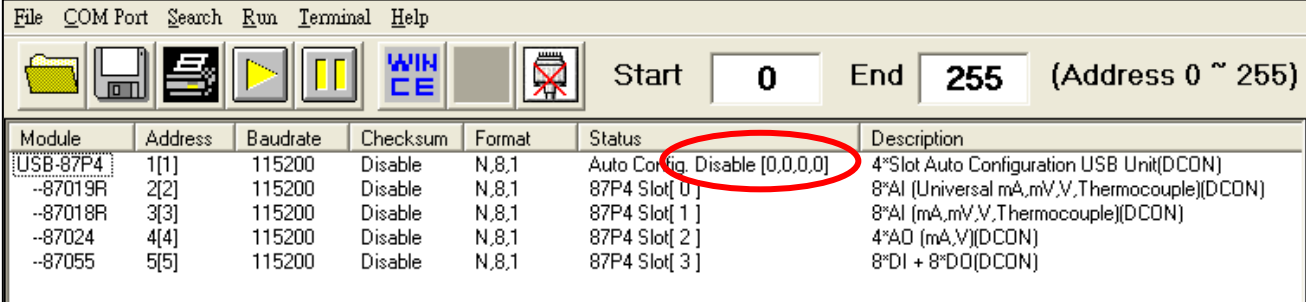

Module	Address	Baudrate	Checksum	Format	Status	Description
USB-87P4	1[1]	115200	Disable	N,8,1	Auto Config. Disable [0,0,0,0]	4*Slot Auto Configuration USB Unit(DCON)
--87019R	2[2]	115200	Disable	N,8,1	87P4 Slot[0]	8*AI (Universal mA,mV,V,Thermocouple)(DCON)
--87018R	3[3]	115200	Disable	N,8,1	87P4 Slot[1]	8*AI (mA,mV,V,Thermocouple)(DCON)
--87024	4[4]	115200	Disable	N,8,1	87P4 Slot[2]	4*AO (mA,V)(DCON)
--87055	5[5]	115200	Disable	N,8,1	87P4 Slot[3]	8*DI + 8*DO(DCON)

Fig. 16 : When 87Pn Auto Config.: Disable, all the module can external communication

In 87Pn "Auto- Config. Disable" mode, doesn't support Auto-Configuration. When the module damaged and replaces another module with the same model number directly. It may be doesn't work well, because of their settings (e.g. Type code) is different. The user must use DCON Utility to re-configure the settings, and replies the normal operation.

Note : In DCON Utility search screen, the message in status column of 87Pn:

The meaning of " Auto Config. Enable [0,X,0,0] " as following description:

0 : Means the module configuration on this slot is successful or have no module.

X : Means the module configuration on this slot is uncorrected.

If the status column of 87Pn shows "Auto Config. Enable [0,0,0,0]", means the "Auto Config." of Dip Switch is switching to the "On", and the I/O configuration of each slot is correct or has no module.

If the status column of 87Pn shows "Auto Config. Disable [0,0,0,0], means the "Auto Config." of Dip Switch is switching to the "Off", and the I/O configuration of each slot can initialization success or have no module.

3.2 Save & Load 87Pn Configure file

When you completed the module configuration, you can press "Save Configuration" to save all the settings of related modules. It can be use for system recover and system backup. In addition, you can press "Load Configuration" to load the prior configuration file. The related format and detail about configure file, please refer to [Appendix D](#).

3.2.1 Save the Configure file:

When all modules has configured properly, you could save the settings as a file to avoid the settings is carelessly changed or need to duplicate the same content of configure. You can refer [3.1.1](#) to configure the modules.

The operation steps is very easy, you check or modify the settings of each I/O module by click "Configure" button, then click "Save Configuration" button and input the description or notes for this configuration file. Finally, input the file name of this project to complete. Please refer to the description as following diagram.

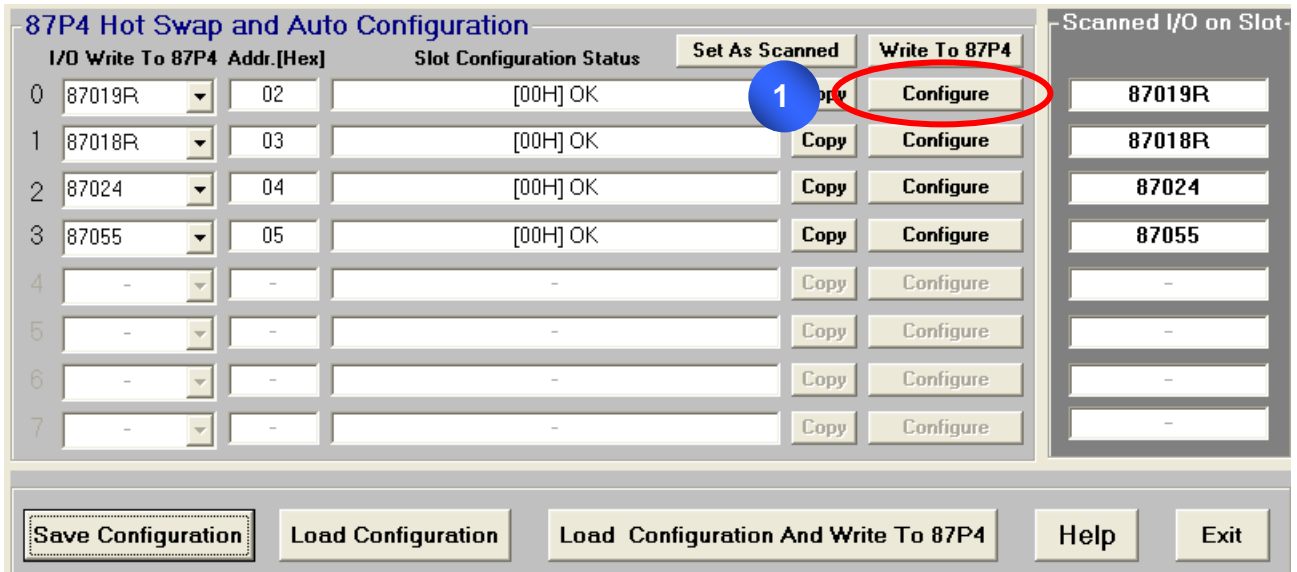
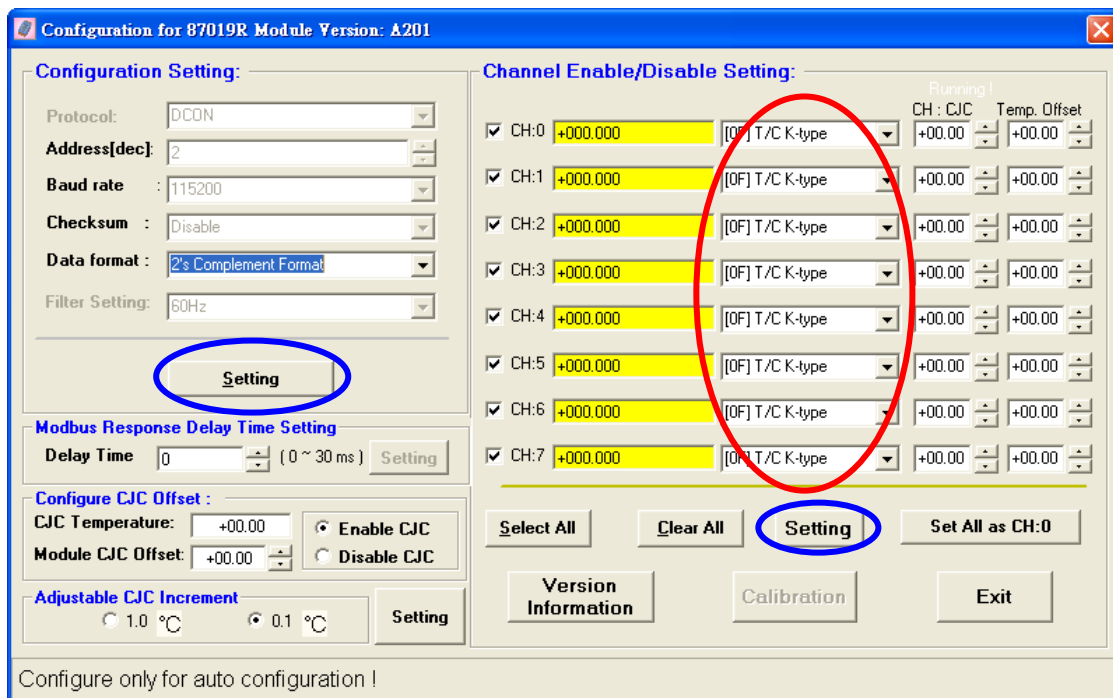
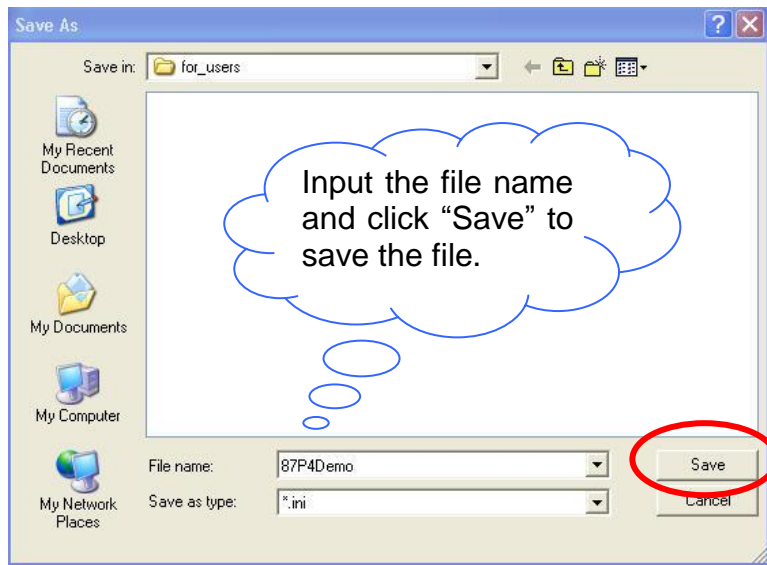
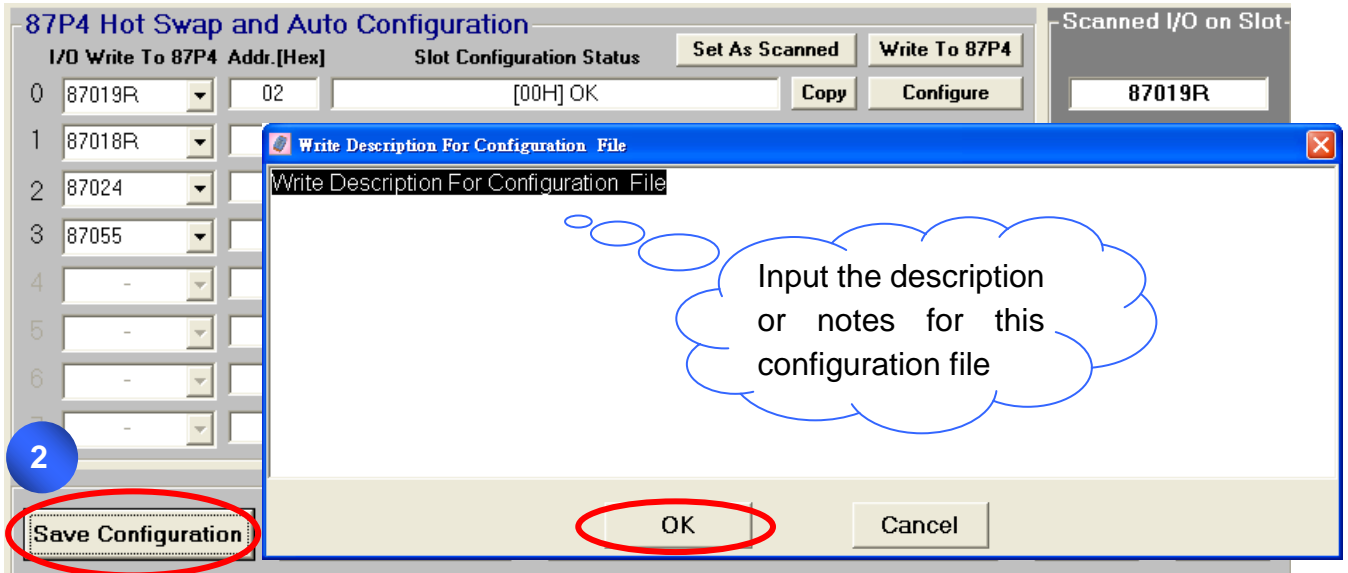

Fig. 17 : Save the configuration file



Note: When you change the settings, please click "Setting" to confirm.



3.2.2 Load the Configure file

You can use this function when you want to duplicate the same settings to other USB-87Pn or load the prior configuration file in the same USB-87Pn. At first, please click "Load Configuration".

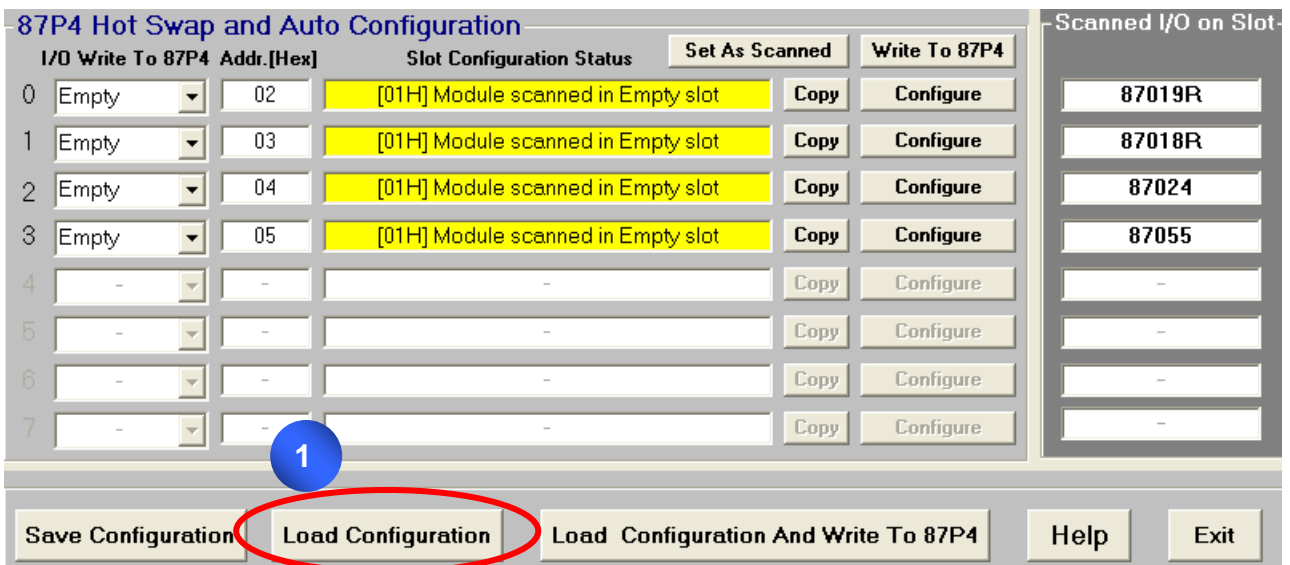
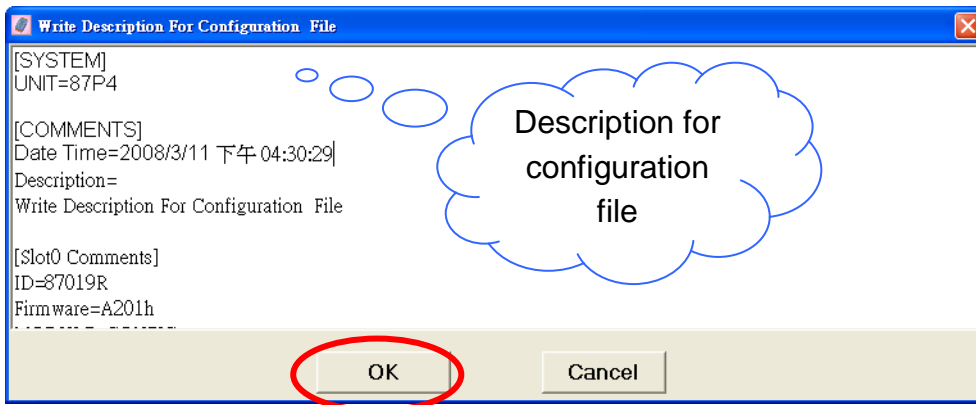
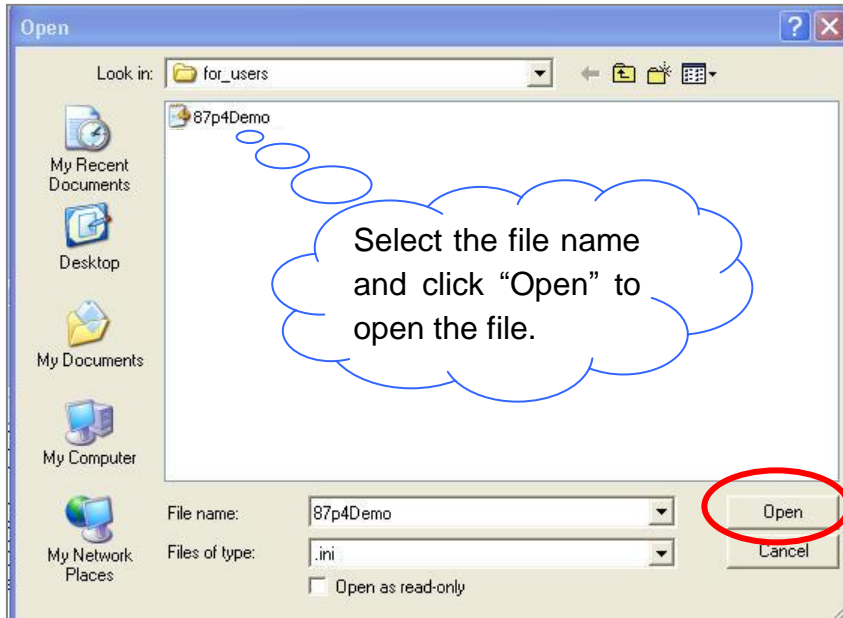
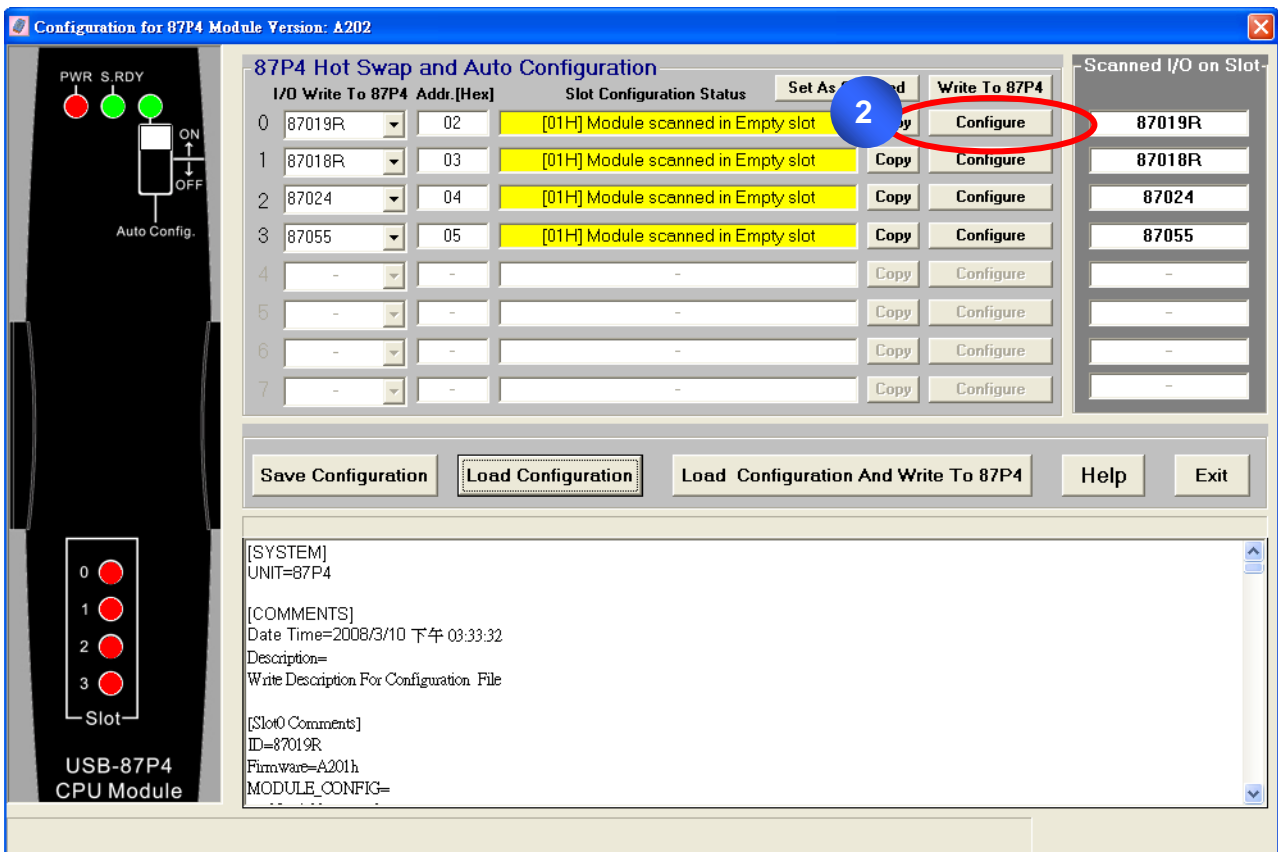

Fig. 18 : Load the configuration file



Click "Configure" to check whether the settings of each module are correct.



Click "Write To 87P4" to write the configuration to 87Pn CPU module.

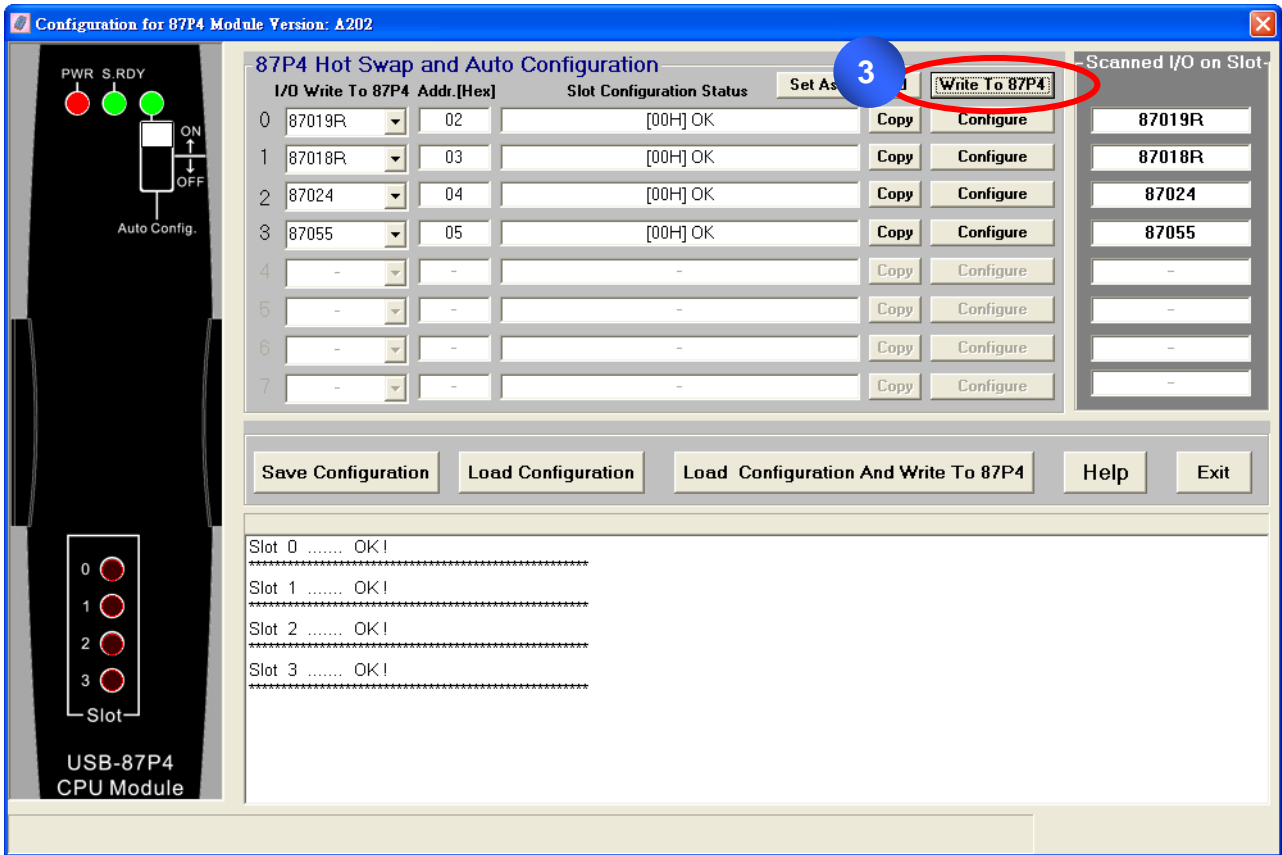

3.3 Load & Write the configure file

If you sure the contents of configure files is what you need, you can load the configuration and write to 87Pn at the same time. As following diagrams, this function is useful for a lot of copy to other 87Pn. Click "Load Configuration And Write To 87P4".

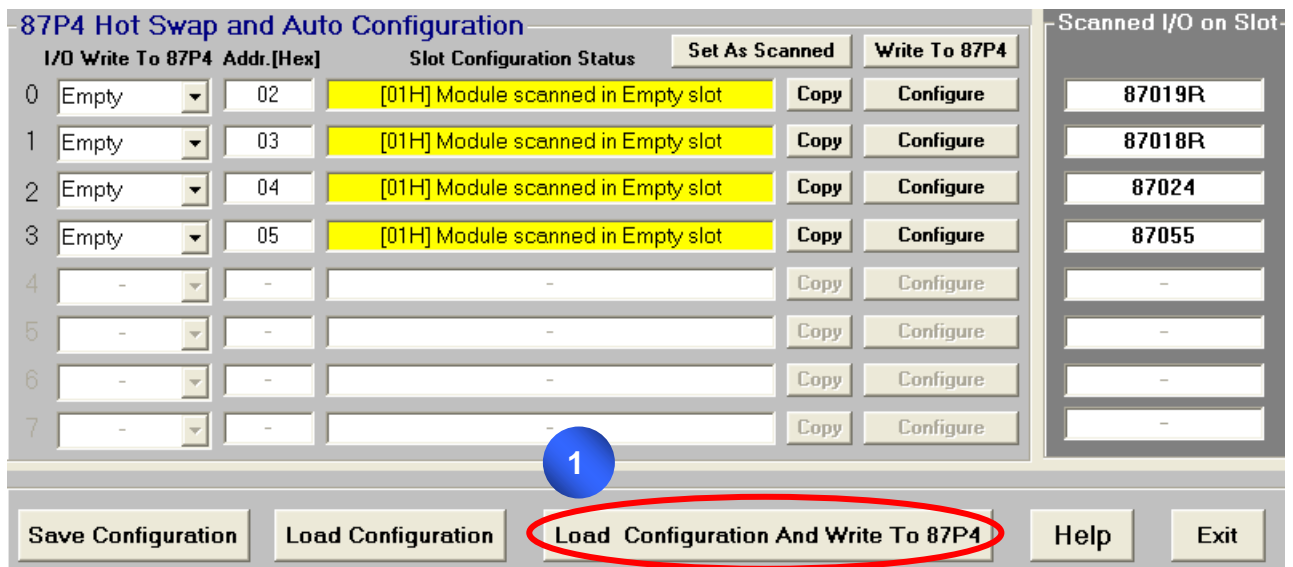
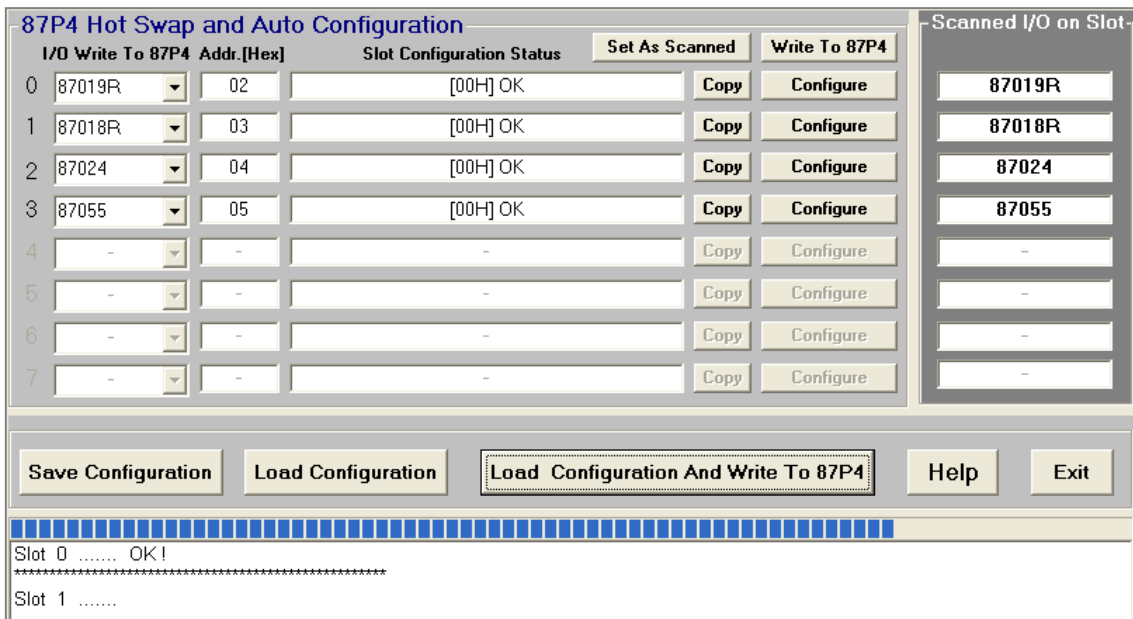
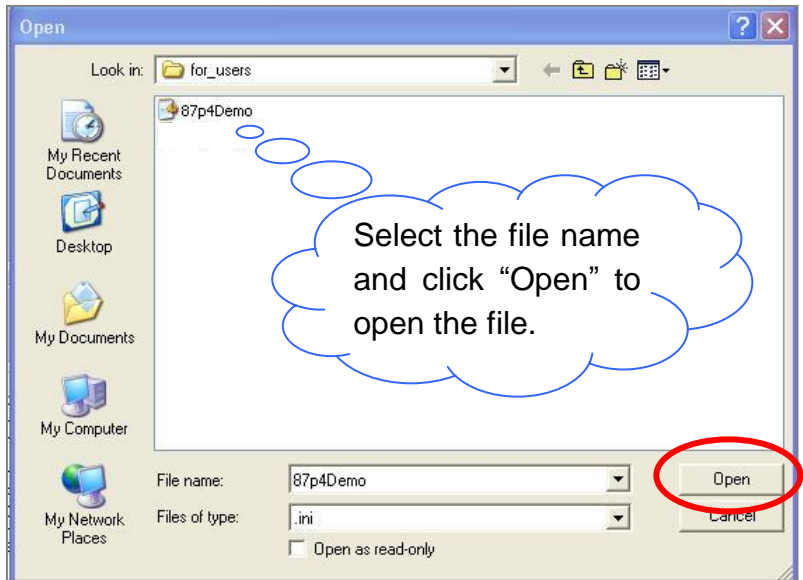

Fig. 19 : Load & Write the configuration file



3.4 Operating in off-line mode:

When you want to use Docn Utility to configure the modules, but your computer did not connect any USB-87Pn. You can configure the settings and save the configuration file in off-line mode.

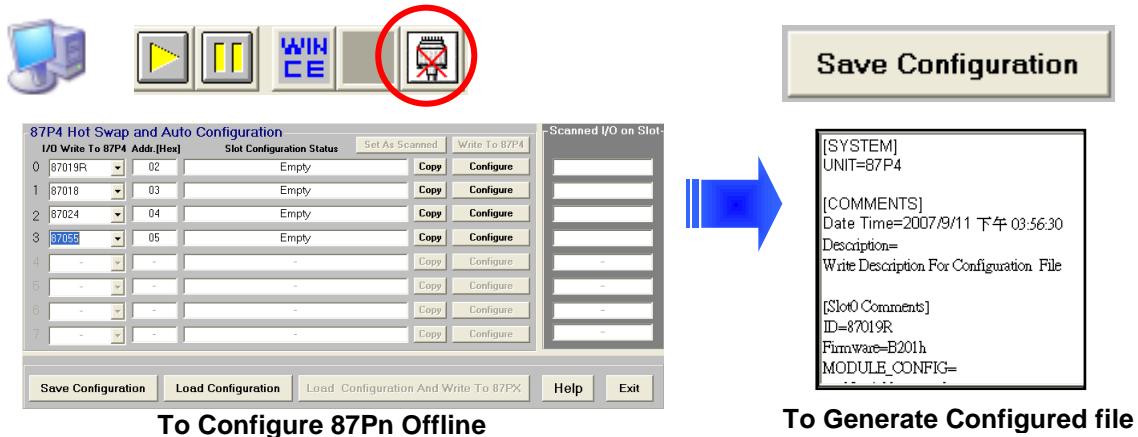

Fig. 20 : Configure and save file in off-line mode

And then you can copy the file to another computer which connected with 87Pn. Run the DCON Utility and enter “configure module” screen. You can click “Load Configuration And Write To 87P4” to write the settings to 87Pn, this usage is convenient for remote support or system backup.

Note: The configure file will be save to C:\ICPDAS\DCON_Utility\for_users

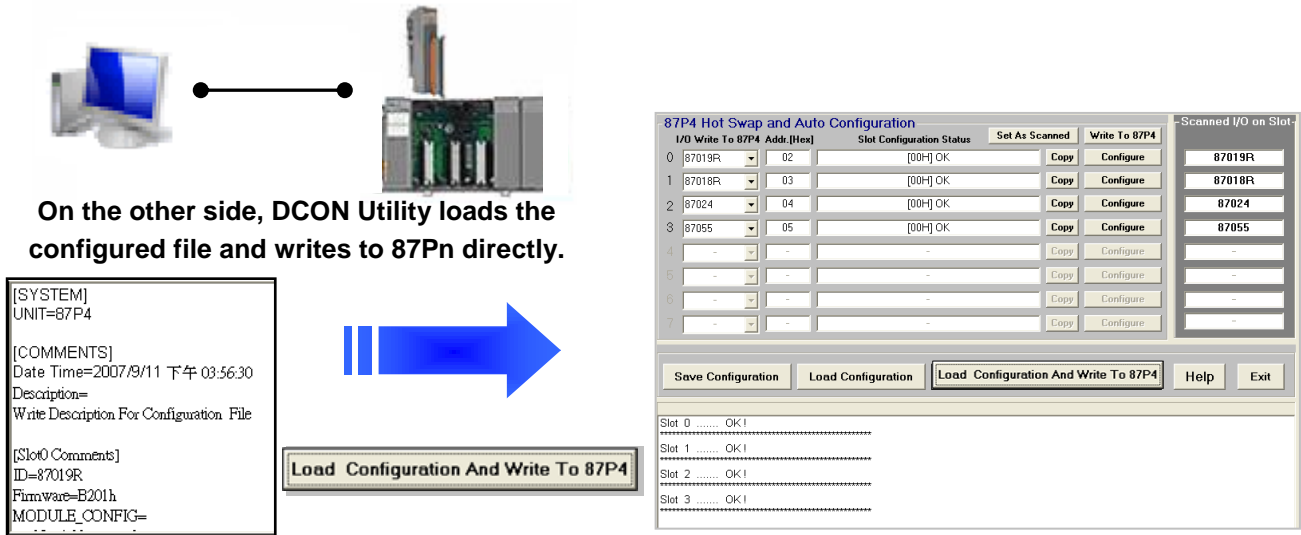

Fig. 21 : Load & write Configuration file through other PC

Follow the steps, you can setup & save the configuration file without connected 87pn and then write this file to any 87Pn.

Step1 : Click off-line button and select the Module ID, Address, Baudrate and Checksum.

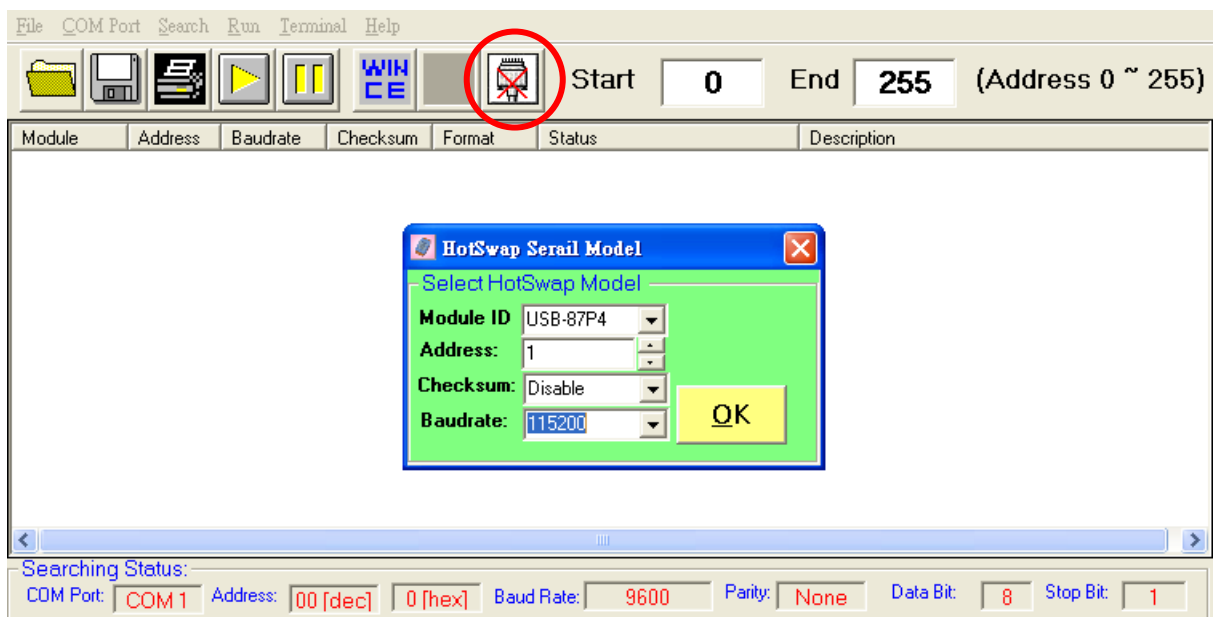
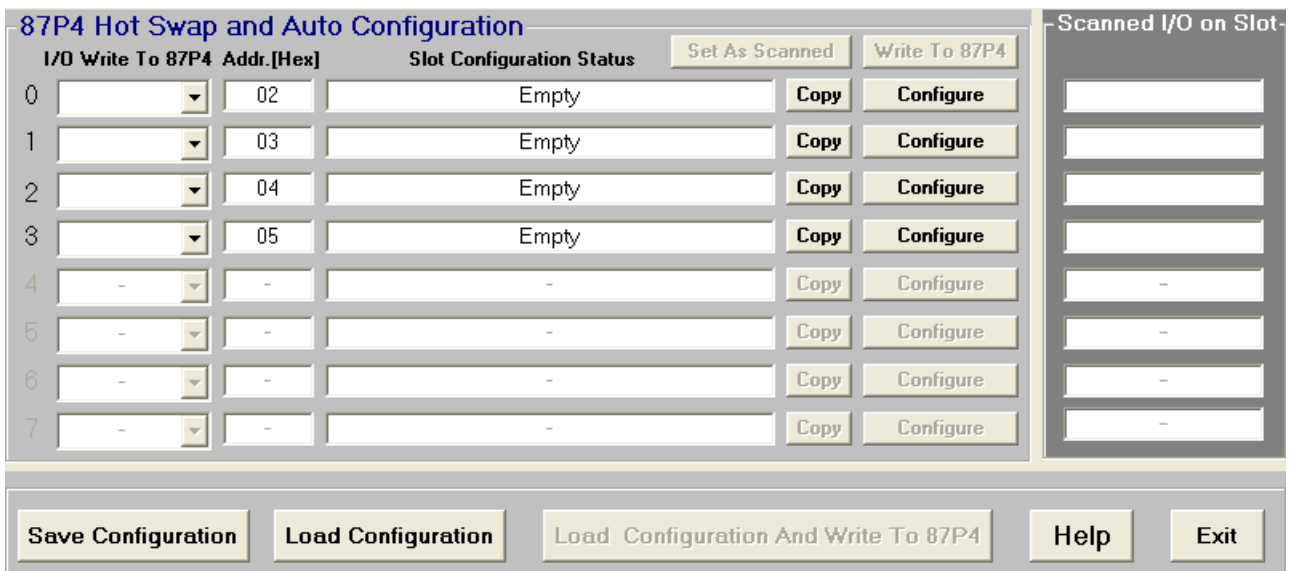
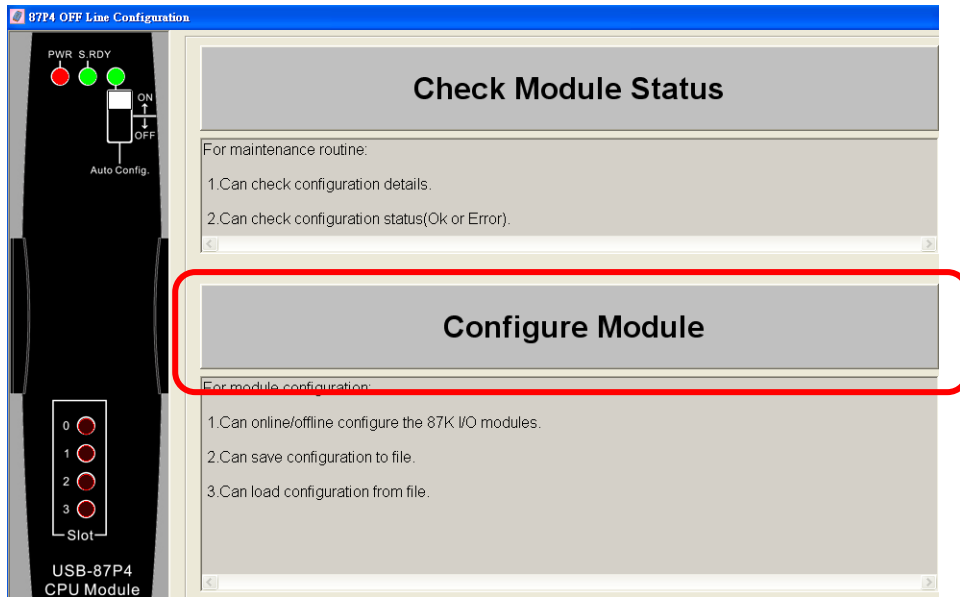

Fig. 22 : Off-line operation

Click “Configure Module” to enter setup screen.



Step2 : Select and configure the I/O modules, then click “Save configuration” to save the settings as the file, or else next time when you open the “configure module” screen in off-line mode, the previous settings will be deleted.

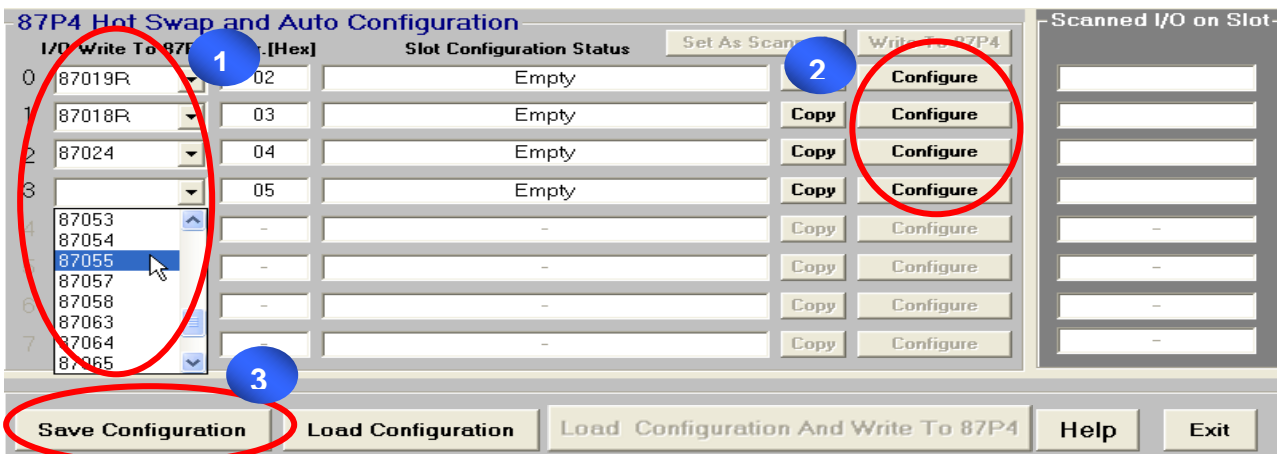
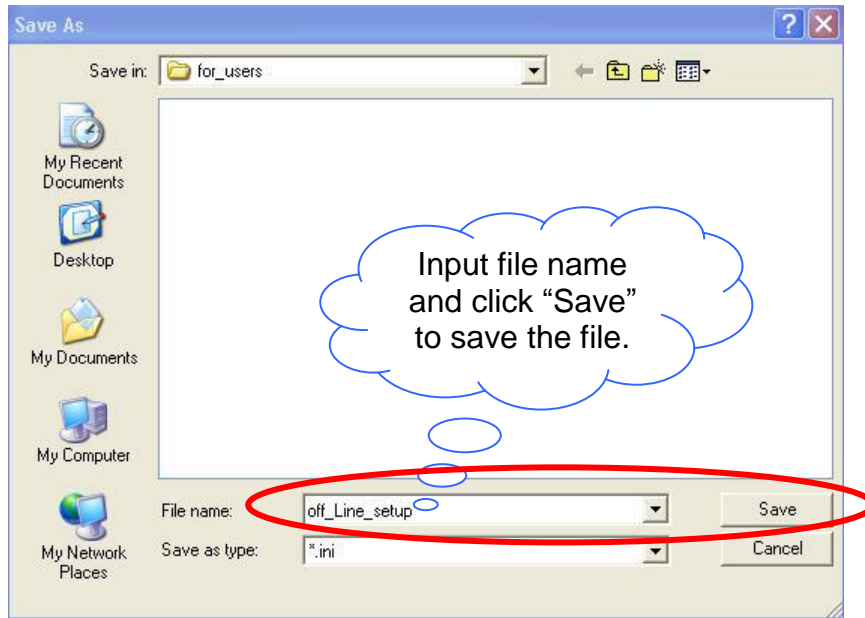

Fig. 23 : Off-line operation – Configure & Save file



Step3 : Run DCON Utility in another computer which has connected with 87Pn, load the settings by “Load configuration” button.

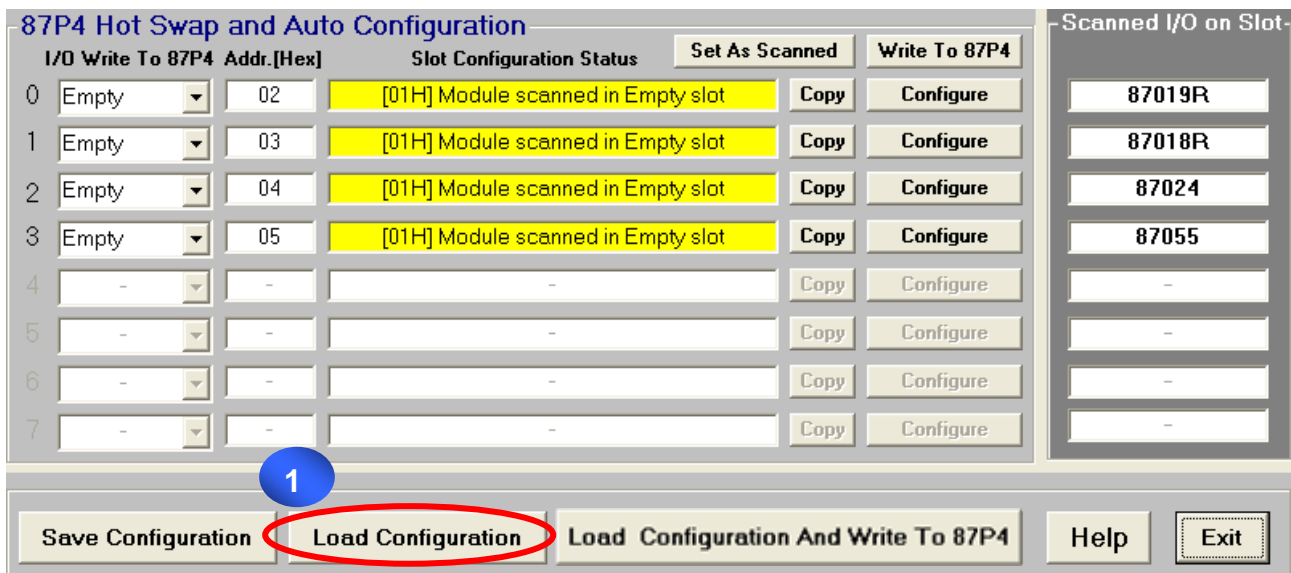
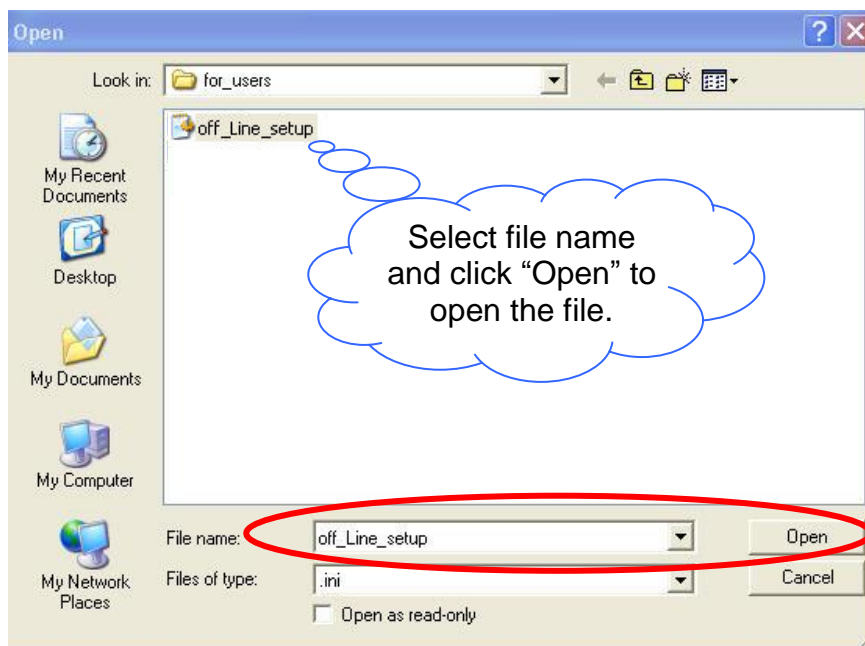

Fig. 24 : Load configure file in another PC



Click "Configure" button to check whether the settings is correct.

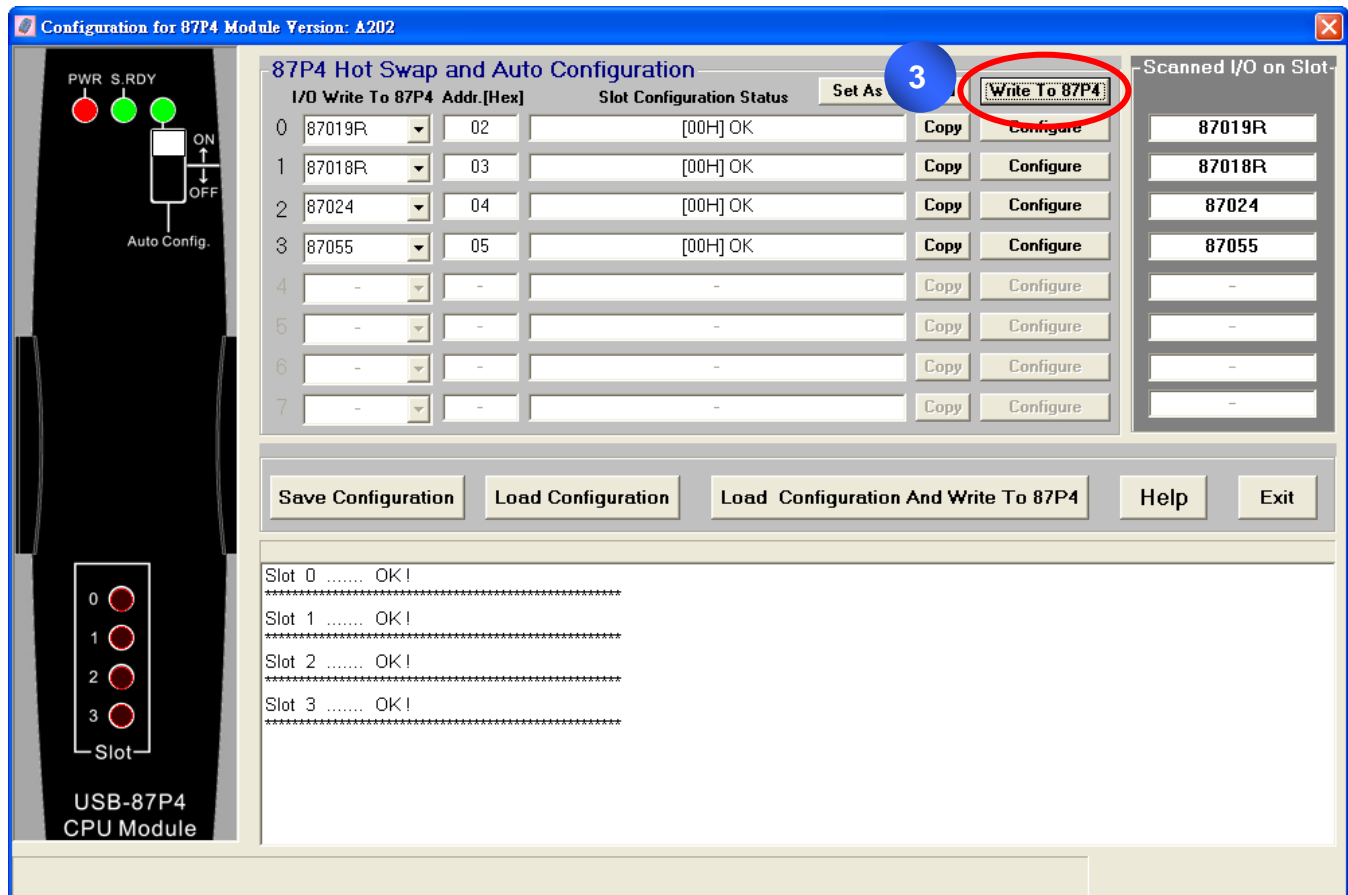
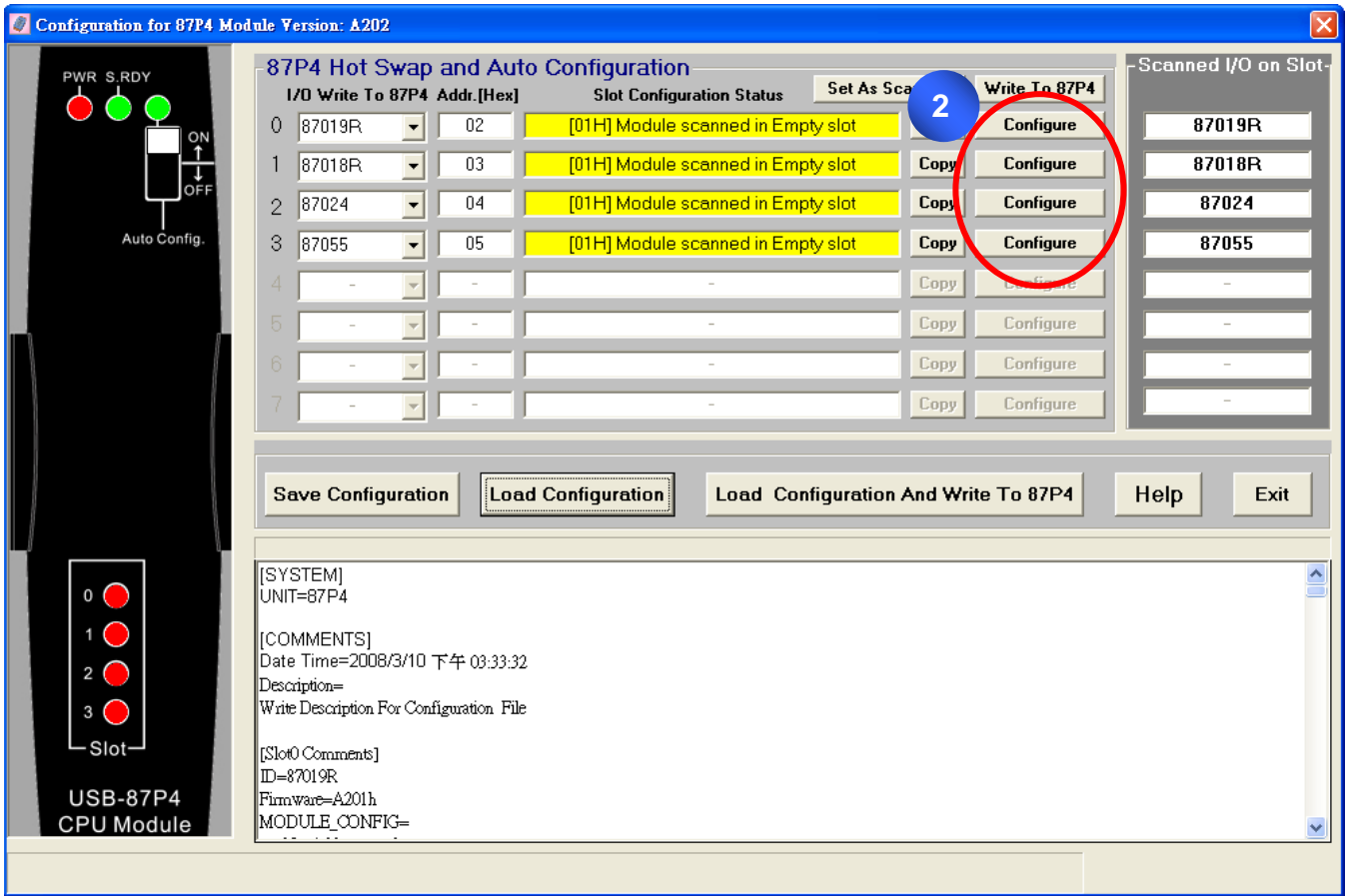
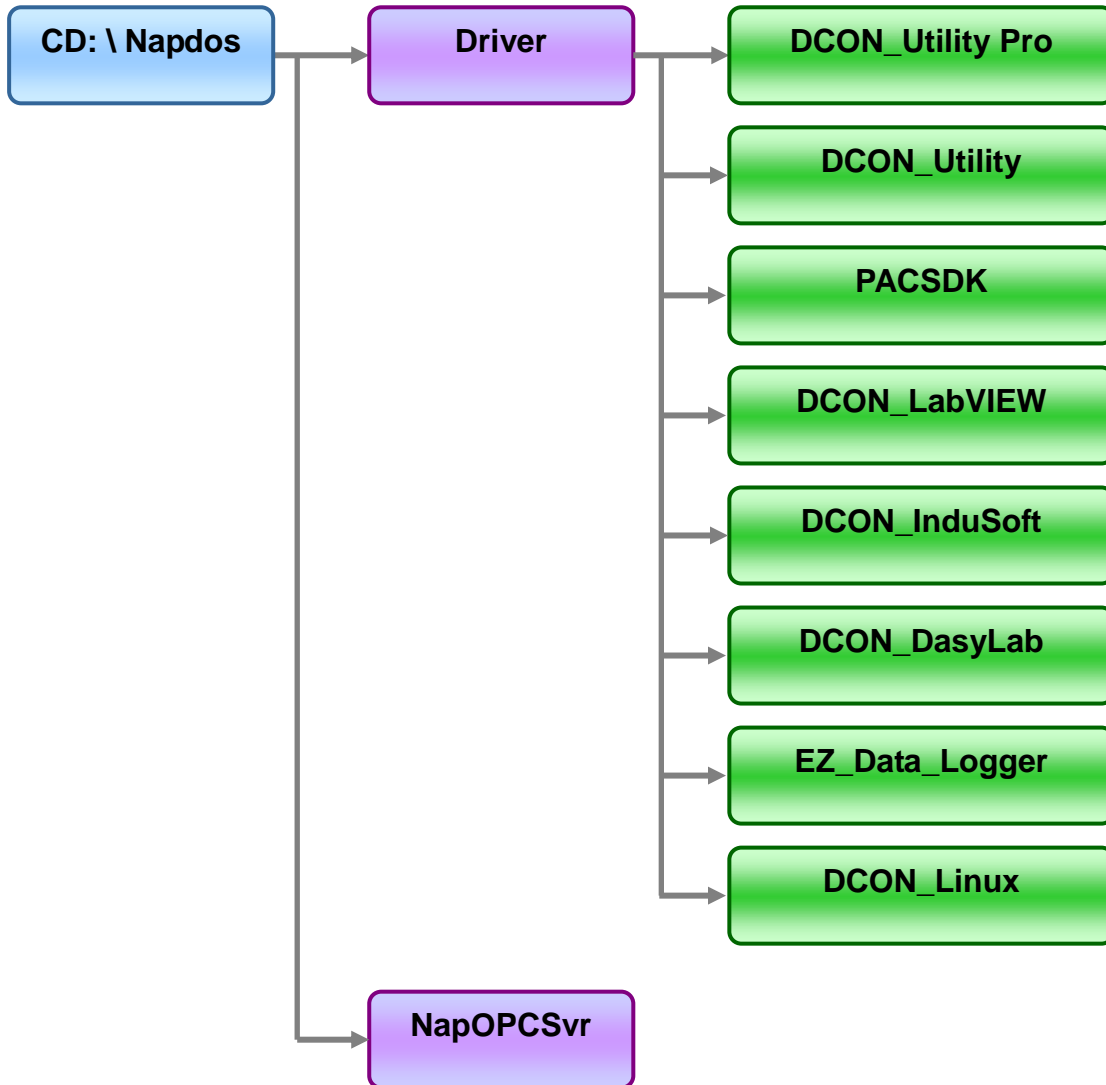

Fig. 25 : Write the settings to USB-87Pn

Chapter 4 Software Development Kits (SDK)

The ICP DAS provides a series of free software development kits, enables the customer to be fast and simply completes the system setup. Related software tools are in the CD, please refer to following diagram:



4.1 PACSDK

PACSDK provide program developers to read the program interface which used on control I/O modules, the position of CD place provides a few basic and simple examples, user can understand how to read the control I/O module through the DLL in following examples:

Supported Windows OS for PC

Operation System
Windows XP
Windows 7
Windows

All document for APCSDK is located at CD or FTP (latest version):

CD: \ Napdos\Driver\PACSDK or

<ftp://ftp.icpdas.com/pub/cd/8000cd/napdos/driver/pacsdk/>

PACSDK can be used on C,C++,C#,Delphi,Borland C and etc Development environment.

About more description about it ,please refer its user manual :

<ftp://ftp.icpdas.com/pub/cd/8000cd/napdos/driver/pacsdk/document/>

4.2 DCON LabVIEW

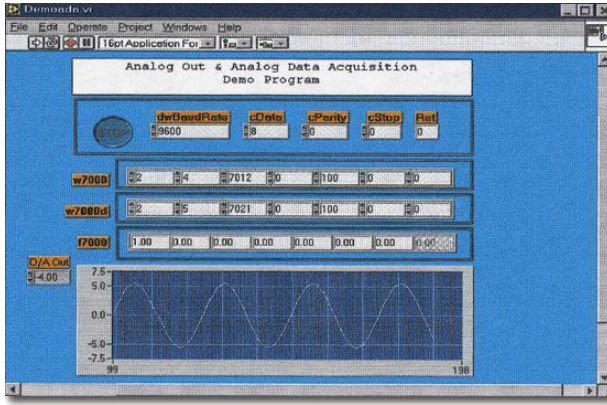

DCON LabVIEW

Bundled driver for LabVIEW

Supported module:

i-7000/8000/87K Series
(With DCON Protocol)

Supported OS:

Windows 98/NT/2K/XP

File Location:

CD: \Napdos\Driver\DCON_Labview

4.2.1 Procedure for using DCON_LabVIEW

Step 1 : Install the DCON LabVIEW by executing:

- CD:\Napdos\Driver\DCON_Labview\DCON_Labview.exe

After installation, the related information can be found as below:

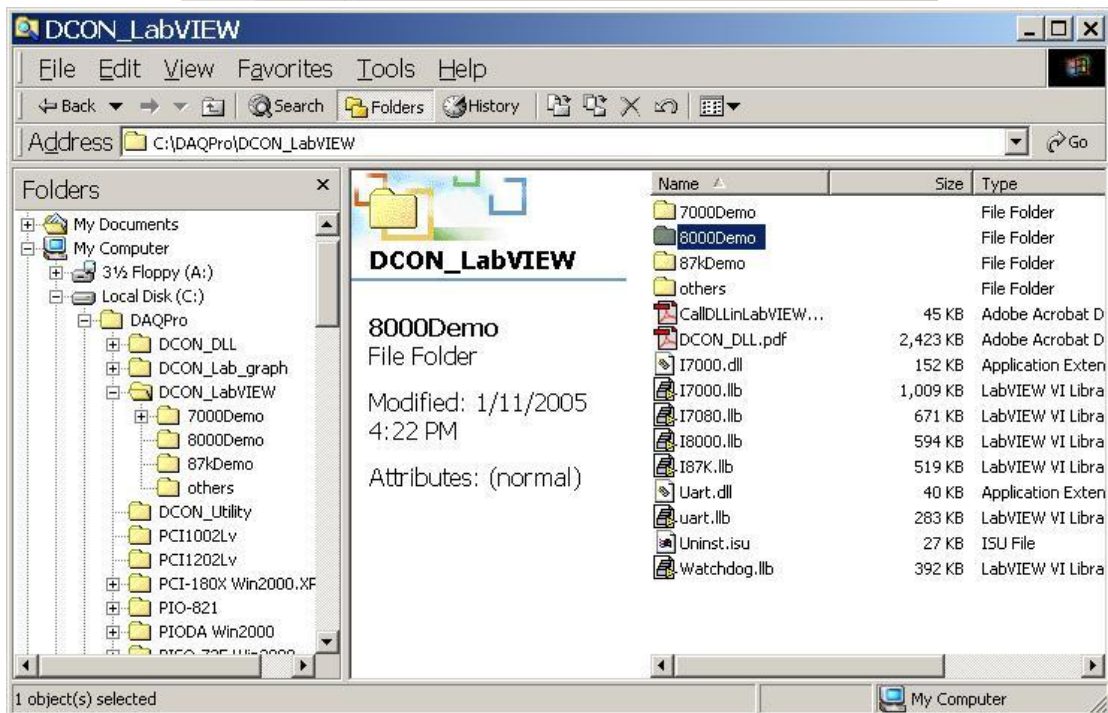
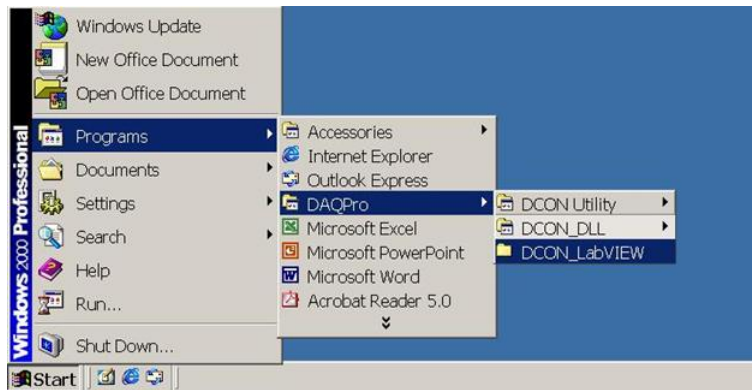

8000 Demo: Demo programs for I-8000 I/O modules.

8000.lib: LabVIEW library contains all sub-vi for I-8000 I/O modules

CallDLLinLabVIEW.pdf: Explains how to call a sub-vi of in LabVIEW.

DCON_DLL.pdf: Descriptions of all sub-function in DCON_DLL.

Step 2: Create a new LabVIEW program. Refer the DCON_DLL.pdf about detail description of the sub-vi and where to select the sub-vi in various library of DCON_LabVIEW.

Step3: Select the sub-vi form Functions Palette >> Select a VI...

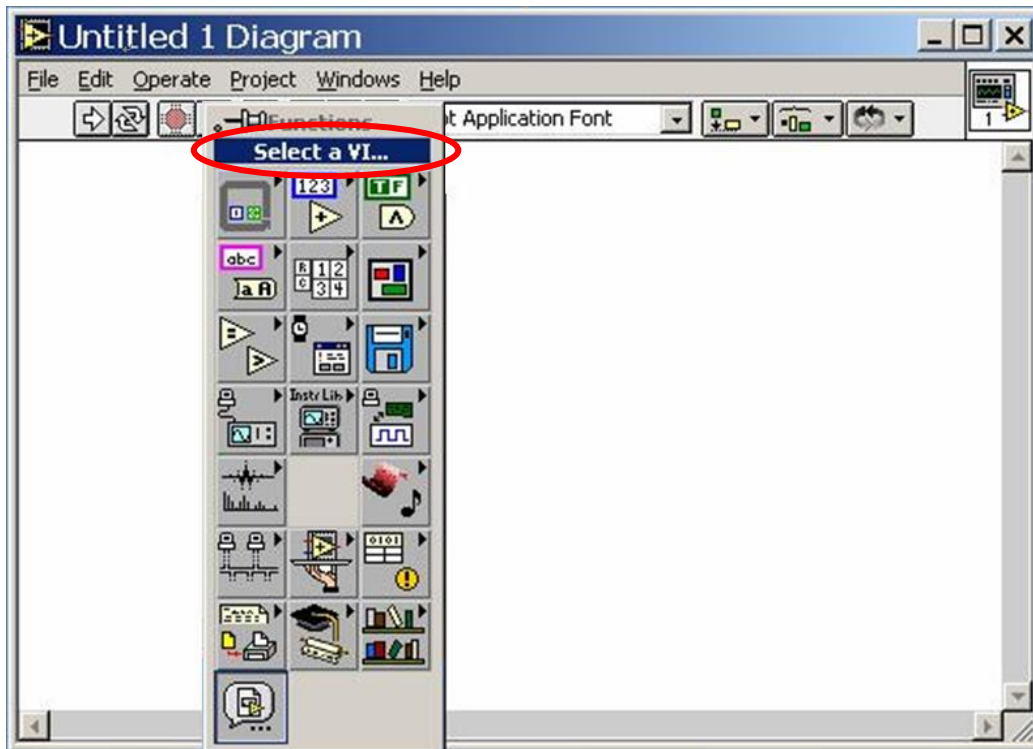

4.2.2 LabVIEW Example (Reading multi-channel analog Input value)

Step4 : Select the target *.lib file (LabVIEW library file)

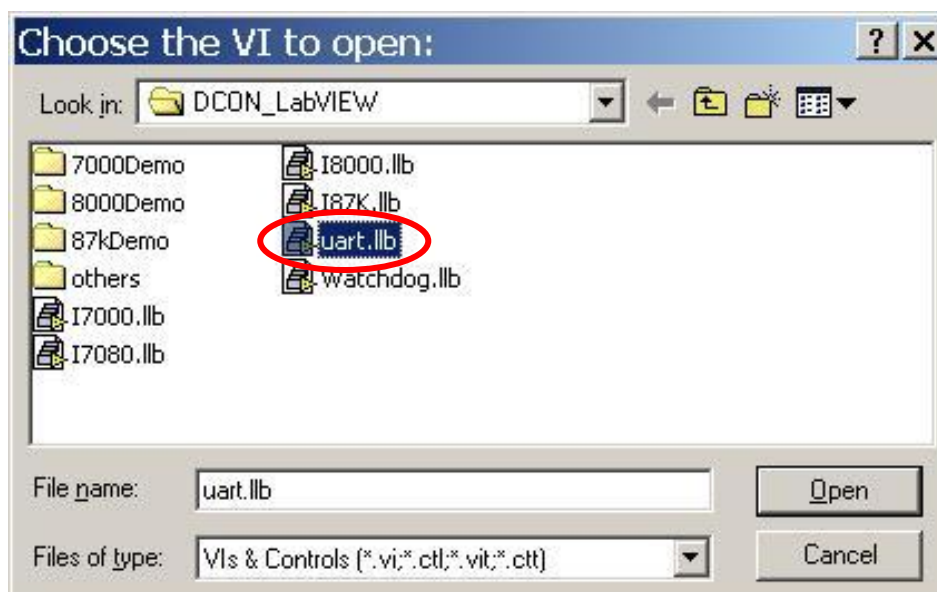

Step5 : Select the desired sub-vi

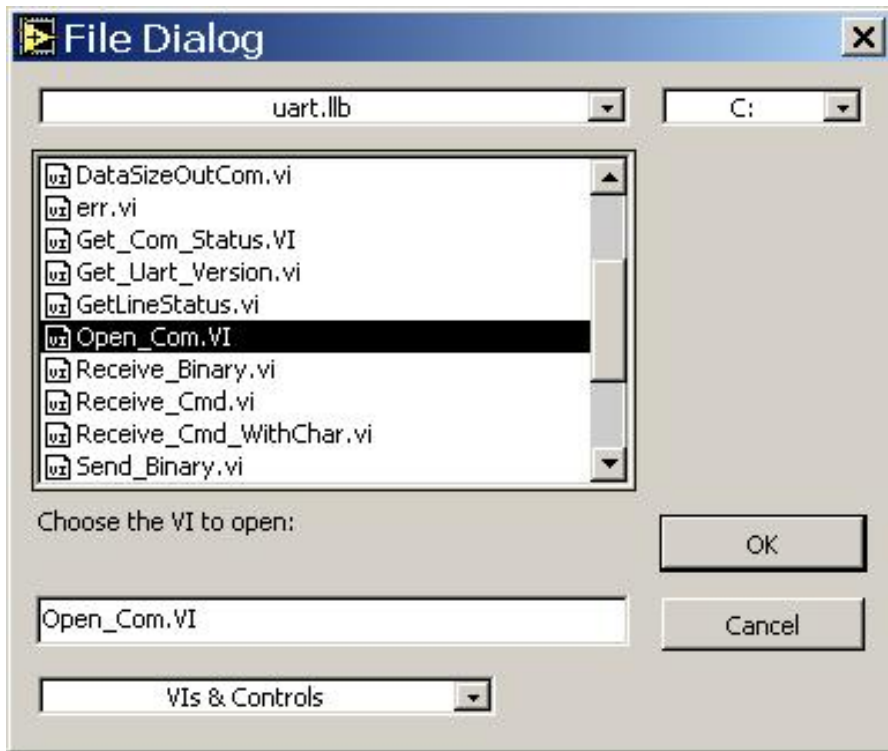

Step6 : Put the icon of selected sub-vi on Block Diagram, refer the “Help” >> “Show Help” or “[DCON_DLL.pdf](#)” in step1 for detail.

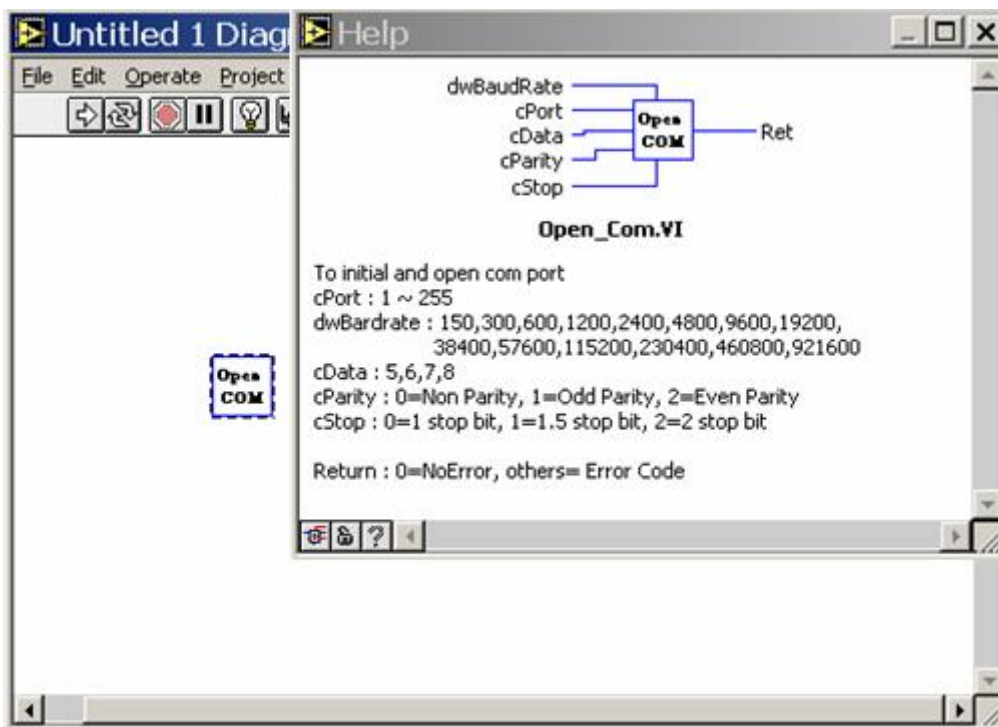

Step7 : Draw the data flow of sub-vi.

4.2.3 LabVIEW Demo Program (Reading multi-channel analog input value)

Step 1: Select the appropriate demo program (ex. AnalogInAll.vi) by the name according with module's function (ex. I-8017 / AI).

Step2: Set the parameters

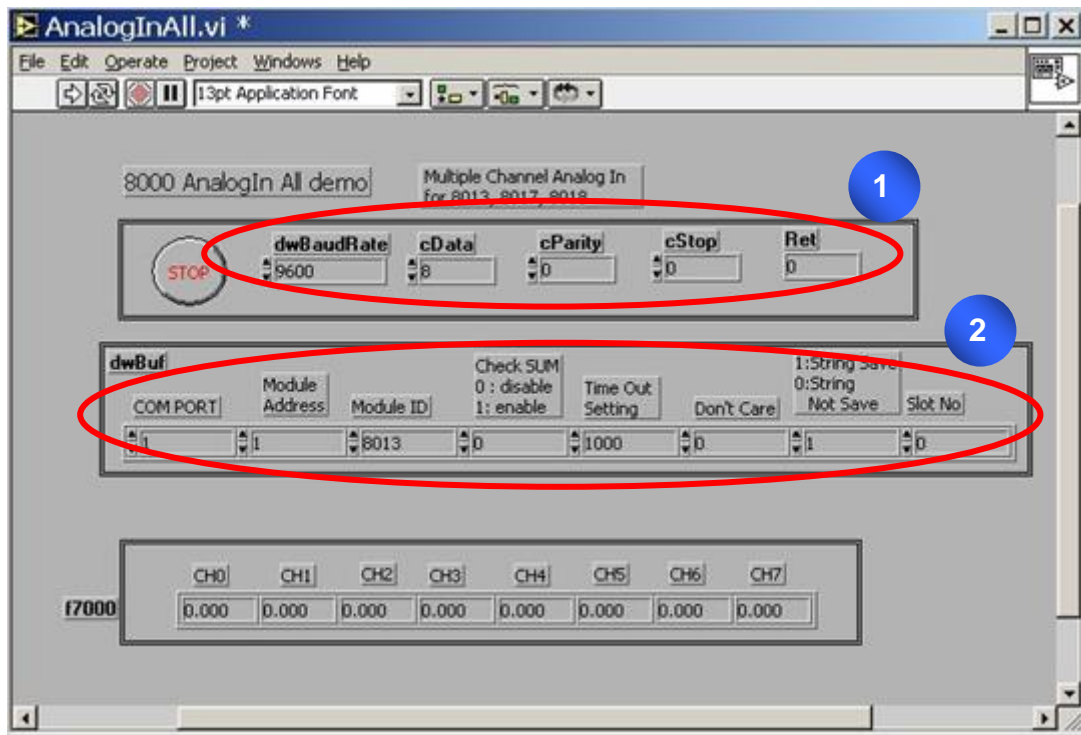

You could also refer the “Help”>>”Show Context Help” for getting the simple description of those parameters.

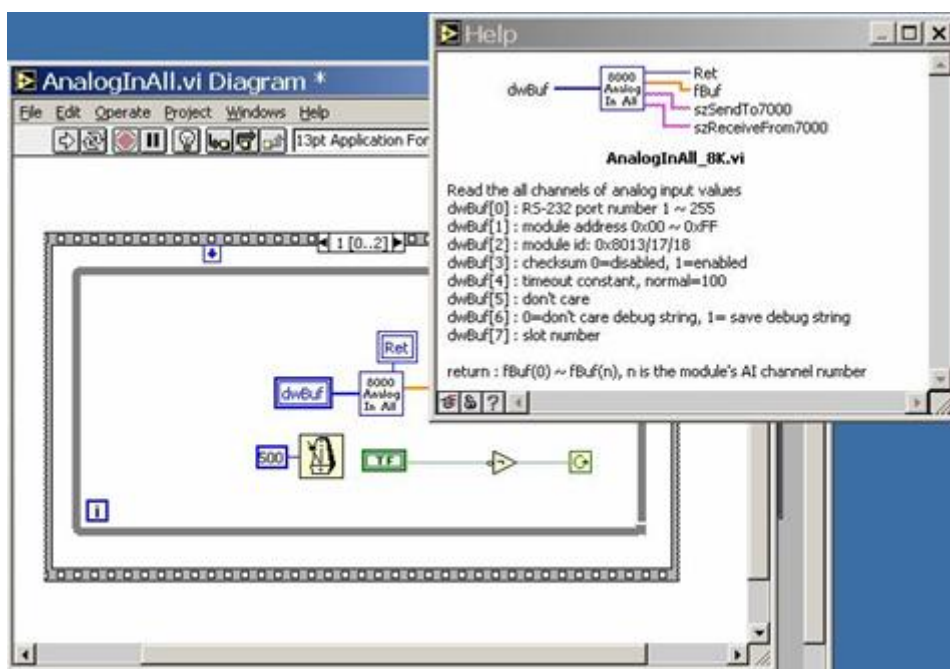

Step3 : Run the Demo.

4.3 DCON InduSoft

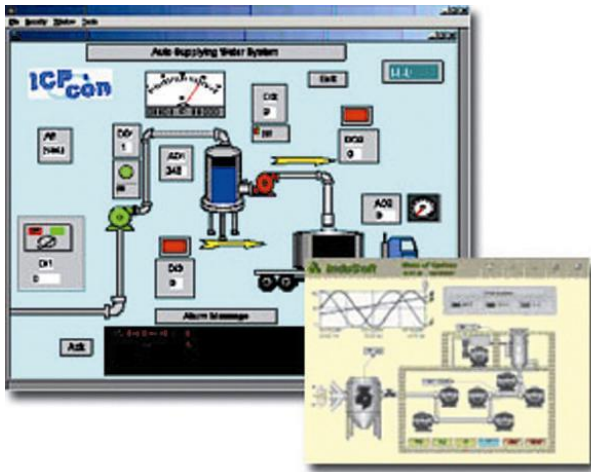

DCON InduSoft

Bundled driver for InduSoft

Supported module:

I-7000/8000/87K Series
(With DCON Protocol)

Supported OS:

Windows 98/NT/2K/XP/CE

File Location:

CD: \Napdos\Driver\DCON_InduSoft

4.3.1 Procedure for using the InduSoft bundled driver

Step 1: Read the basic and important documents

Readme.txt: contains the basic and important information, including:

- Files on the shipped CD

Reversion.txt: contains the reversion information, including

- Bugs fixed
- New modules supported

Step 2: Install the InduSoft bundled driver by executing

- CD:\Napdos\Driver\DCON_InduSoft\Setup\setup.exe

Step 3: Read the manuals describing how to start

- The DCON.pdf user's manual describes how to use the InduSoft bundled driver

Step 4: Run the demo programs (ICPDriverTest.zip) to test I/O modules and learn the functions

4.3.2 InduSoft Example (Reading an analog input value)

The following is an example of reading analog values from an I-87018 inserted in slot 0 of an 8410/8810.

Step 1: Run the DCON Utility to configure the I/O modules

Step 2: Run InduSoft and create a new project

Step 3: Include the DCON driver

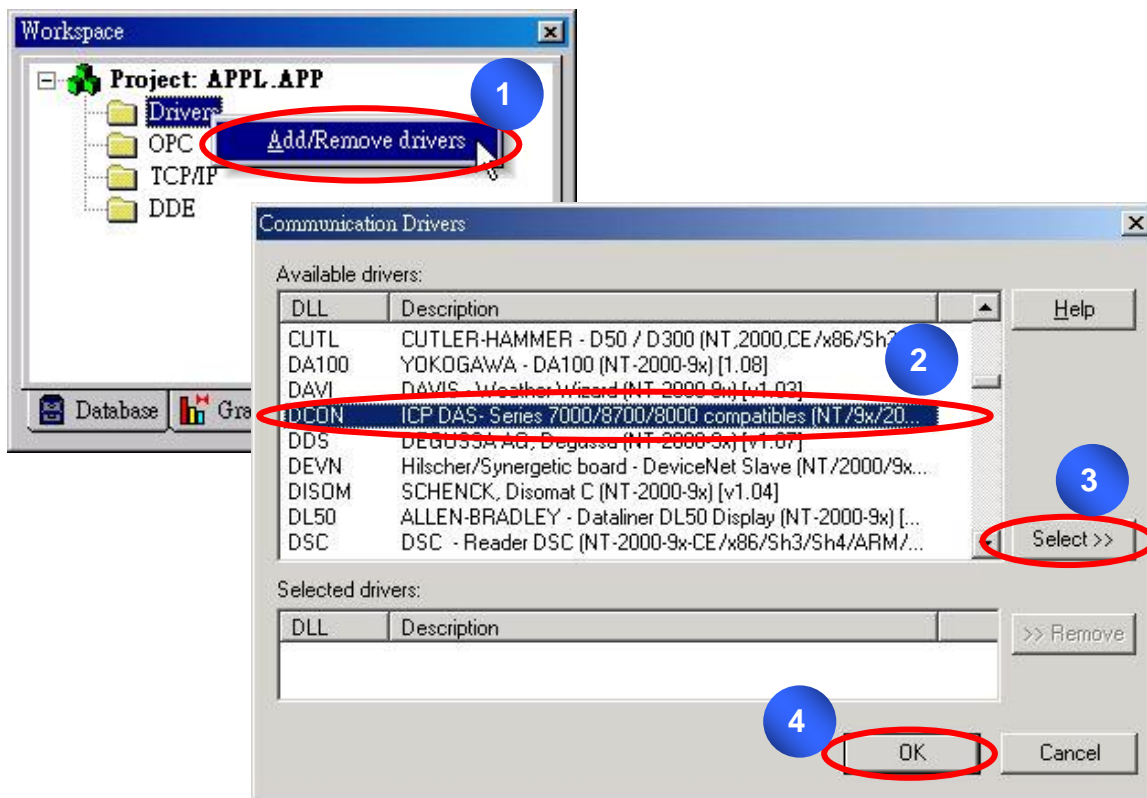

Step 4: Setup DCON driver

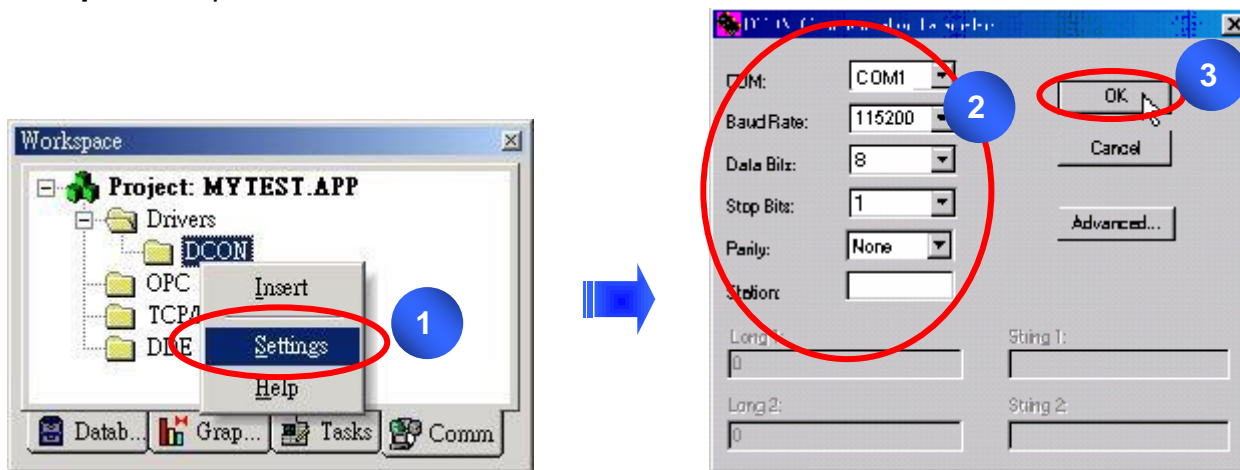

Step 5 : Insert tags to connect to I/O modules

The address format is [Address : Module ID : Slot : Channel]

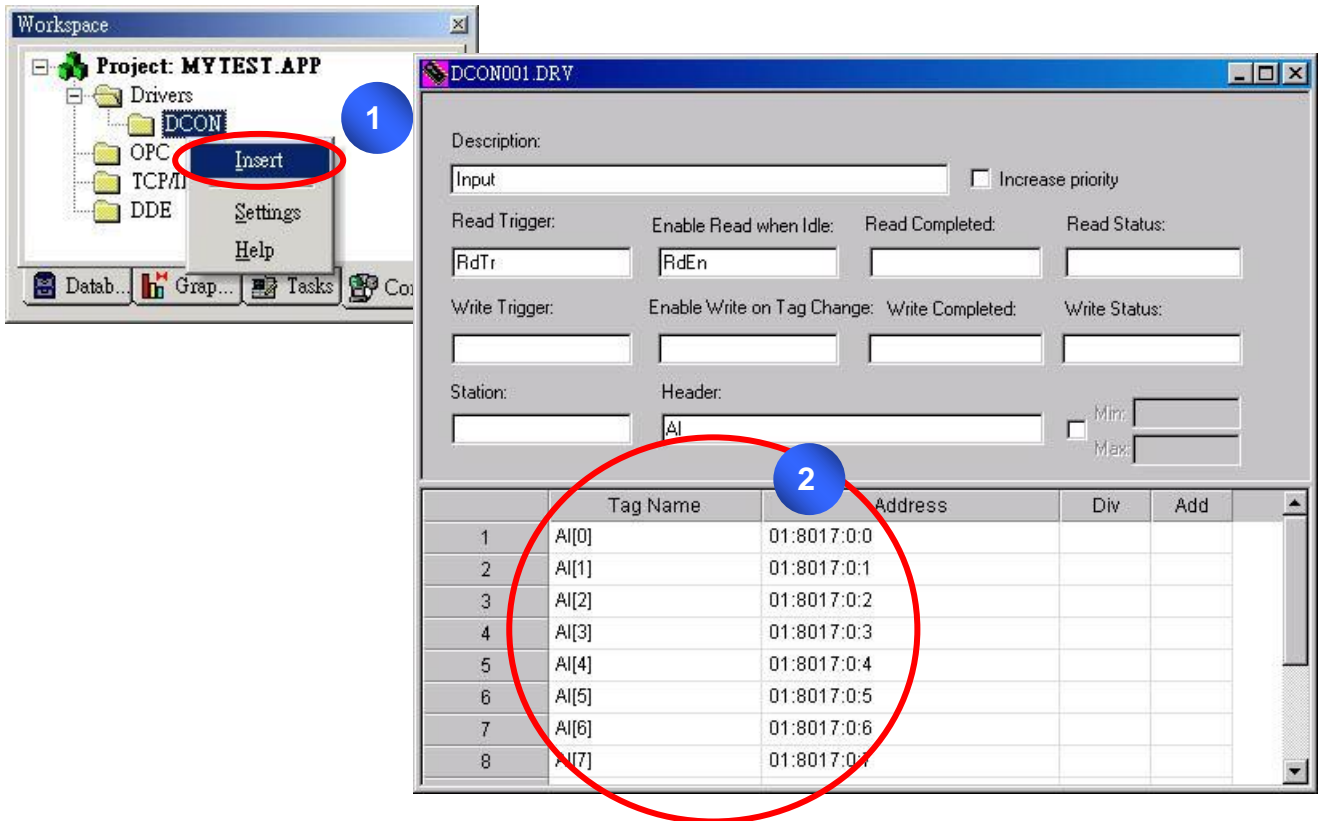

Step6 : Arrange all the components on the form

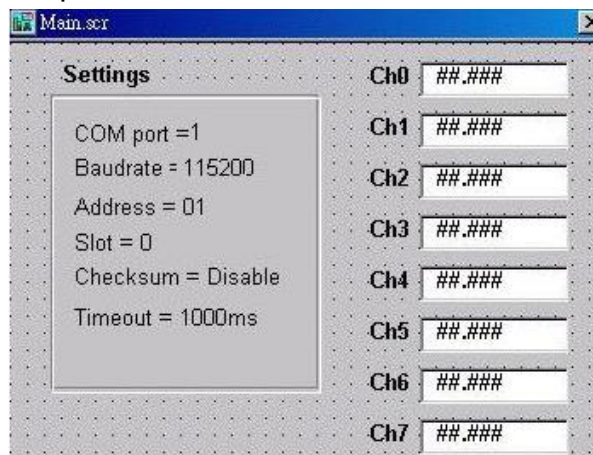

Step7: Double click the text box to assign a tag to it.

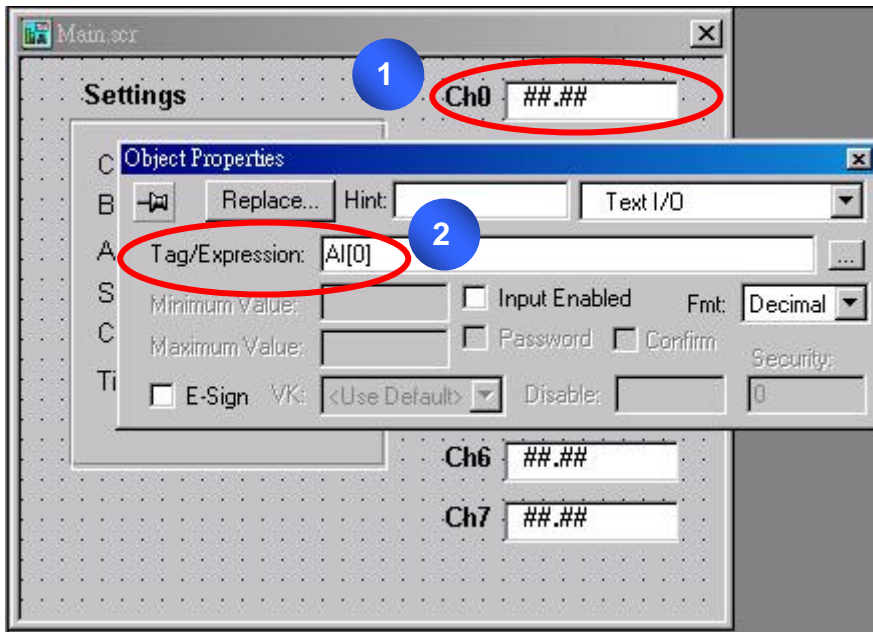

Step8 : Run the project

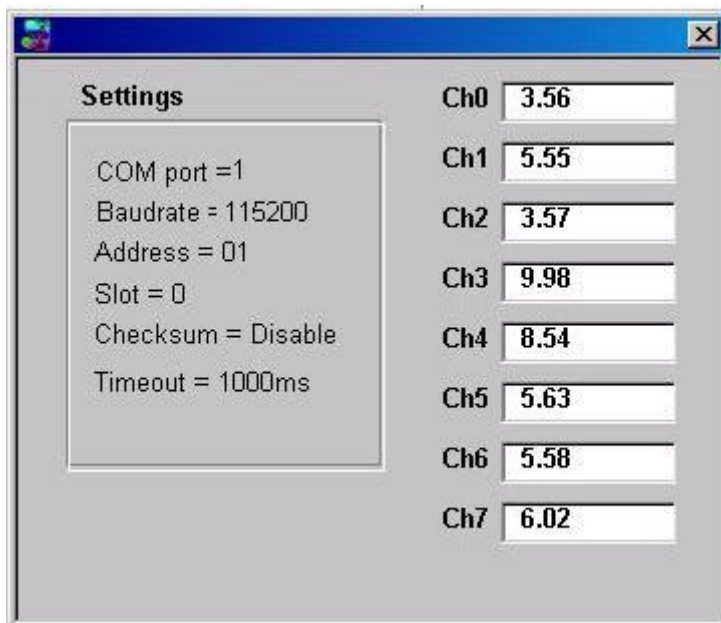

4.4 NAP OPC Server



[NAP OPC Server](#)

OPC Server

Supported Module:

i-7000/8000/87K Series
(With DCON Protocol)

Modbus embedded controller
ISaGRAF embedded controller

Supported OS:

Windows 98/NT/2K/XP/CE

File Location:

CD:\Napdos\NapOPCSvr

OPC (OLE for Process Control) is the first standard resulting from the collaboration of a number of leading worldwide automation suppliers working in cooperation with Microsoft. Originally based on Microsoft's OLE COM (component object model) and DCOM (distributed component object model) technologies, the specification defined a standard set of objects, interfaces and methods for use in process control and manufacturing automation applications to facilitate interoperability. The COM/DCOM technologies provided the framework for software products to be developed. There are now hundreds of OPC Data.

4.4.1 Procedure for using the OPC Server

Step 1: Read the basic and important documents

Readme.txt: contains the basic and important information, including

- Files on the shipped CD

Reversion.txt: contains the reversion information, including

- Bugs fixed
- New modules supported

Step 2: Install the OPC Server by executing

- CD:\Napdos\NapOPCSvr\NapOPCServer.exe

Note: If there is an older version of Nap OPC Server installed on the PC, It must be uninstalled before installing the new version.

Step 3: Read the manuals describing how to start

- The [NapOPCSvr.pdf](#) is the user's manual describing how to use the OPC Server

4.4.2 OPC Server Example (Reading an analog input value)

The following is an example of reading analog values from an I-87018 inserted in slot 0 of an

8410/8810.

Step 1: Run the DCON Utility to configure the I/O modules

Step 2: Run the OPC Server to search for I/O modules on COM1

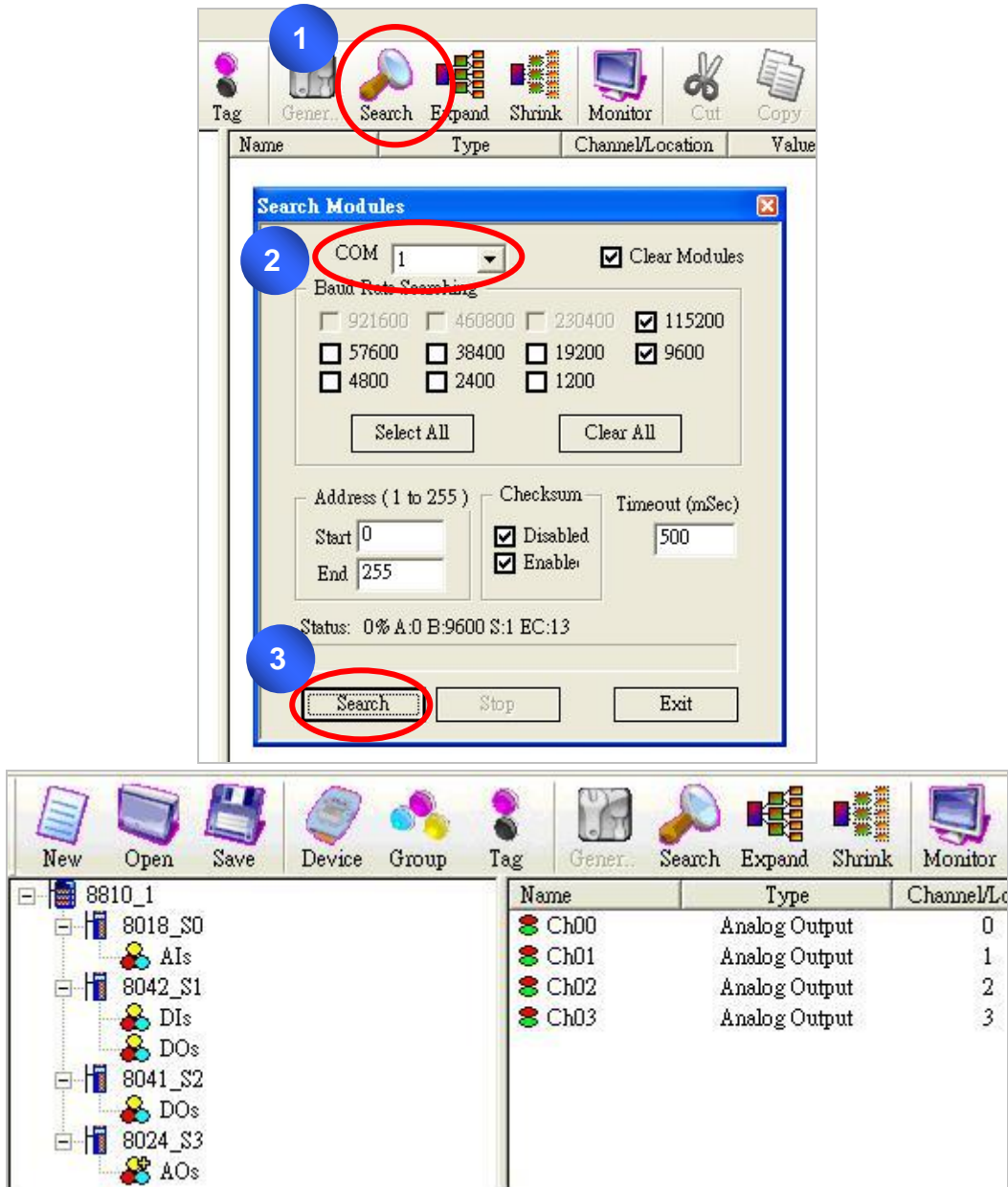

Step 3: Save the configuration and close the OPC Server

Step 4: Run SCADA software to connect to the OPC Server

The OPC Server user's manual lists the procedures for the following SCADA software:

■ LabVIEW	■ National	■ WIZCON
■ iFix	■ InduSoft	■ Citect

Please refer to "Chapter 4 Connecting to the OPC Server" for more details.

Appendix A : Dimension

A.1 – USB-87P1

Unit: mm

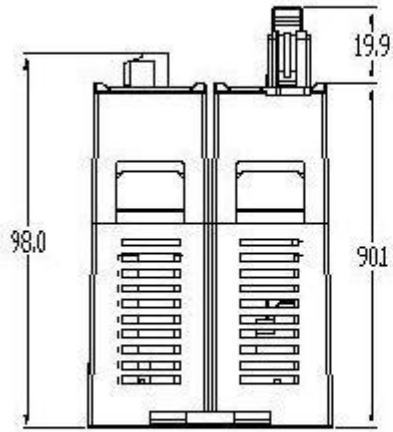

Top View

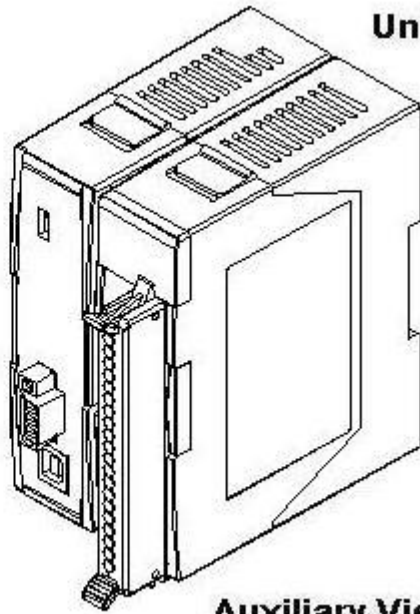

Auxiliary View

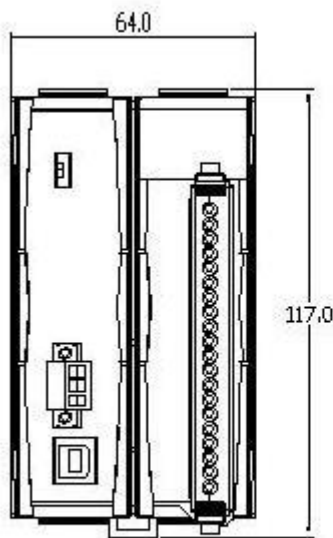

Front View

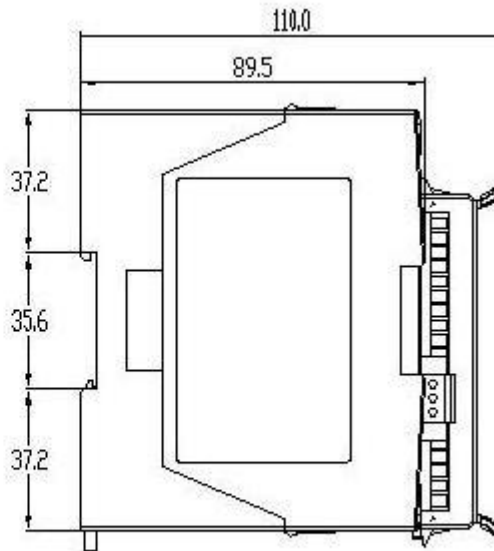

Right Side View

A.2 – USB-87P2

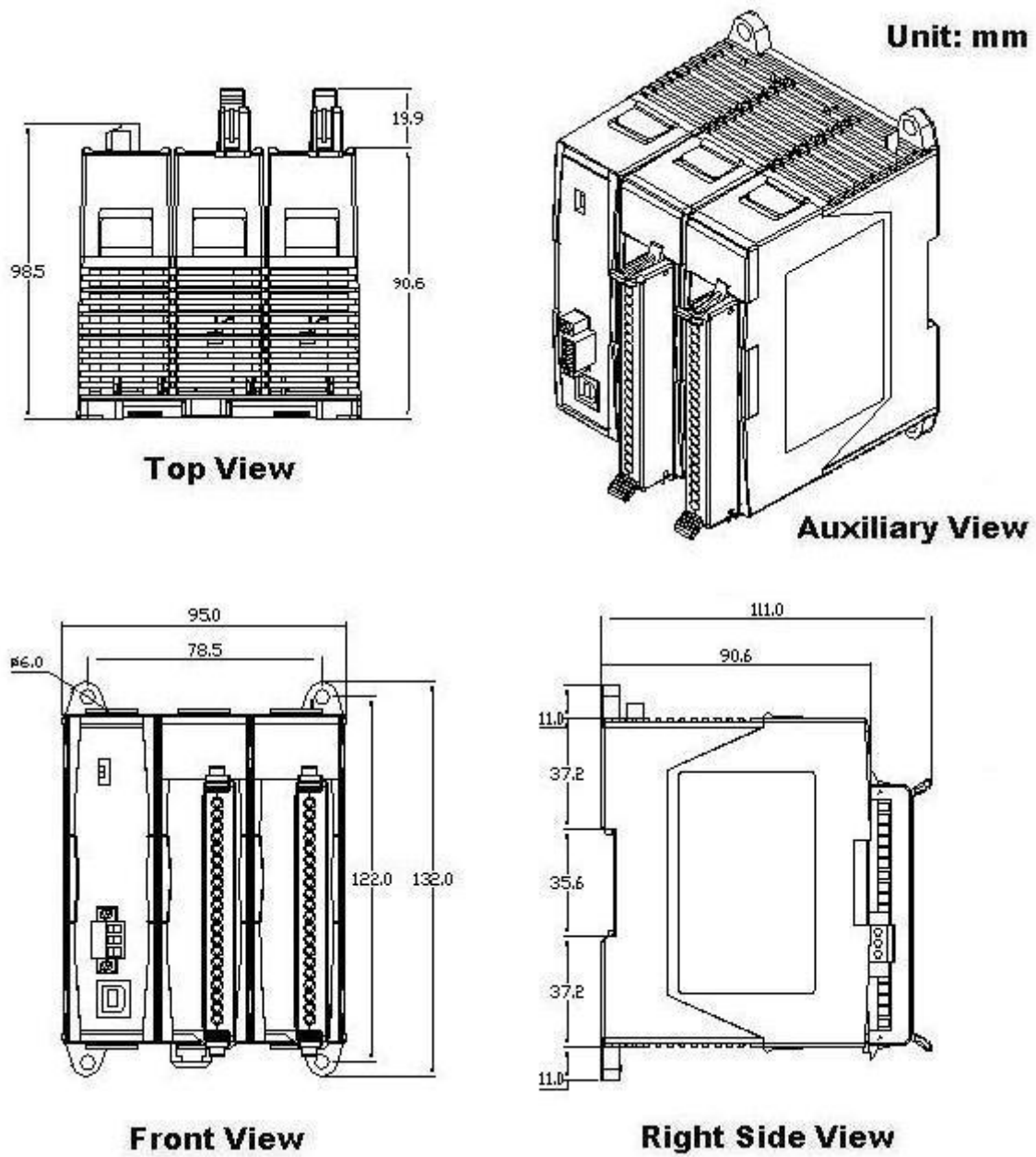

A.3 – USB-87P4

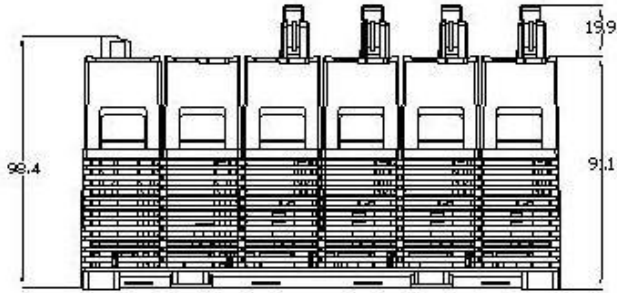

Top View

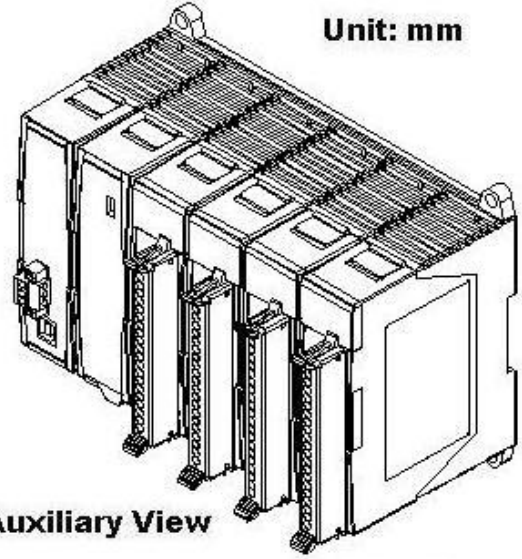

Auxiliary View

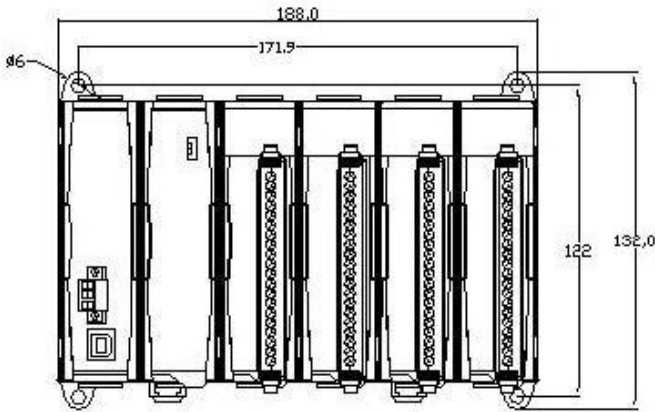

Front View

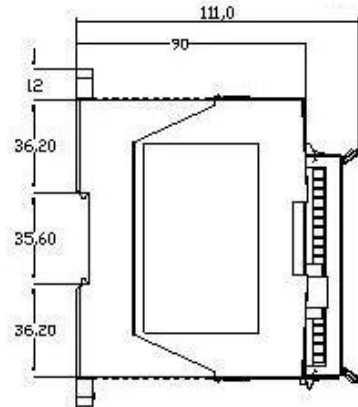

Right Side View

A.4 – USB-87P8

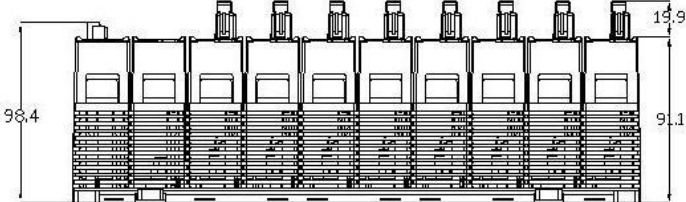

Top View

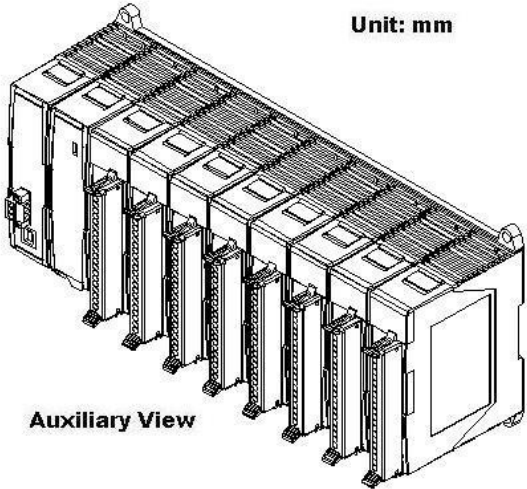

Auxiliary View

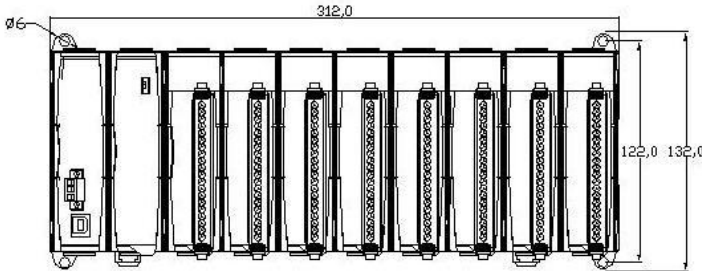

Front View

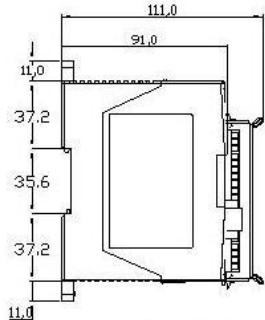

Right Side View

Appendix B : Compare USB-87Pn with I-87Kn

Note: I-87K I/O module has divides into the high profile (new version) and the low profile (old version) two kinds, **only I-87K high profile series I/O modules can support Hot Swap and Auto-Configuration function correctly.**

USB-87Pn & I-87Kn I/O unit comparison

Supported	USB-87Pn with Auto Config. Enable	USB-87Pn with Auto Config. Disable	I-87Kn
I-87K Low Profile module	--	--	☺
I-87K High Profile module	☺	☺	☺
I-87K module Hot Swap	☺	☺	--
Auto- Communication parameter Setup	☺	☺	--
Auto-Configuration	☺	--	--

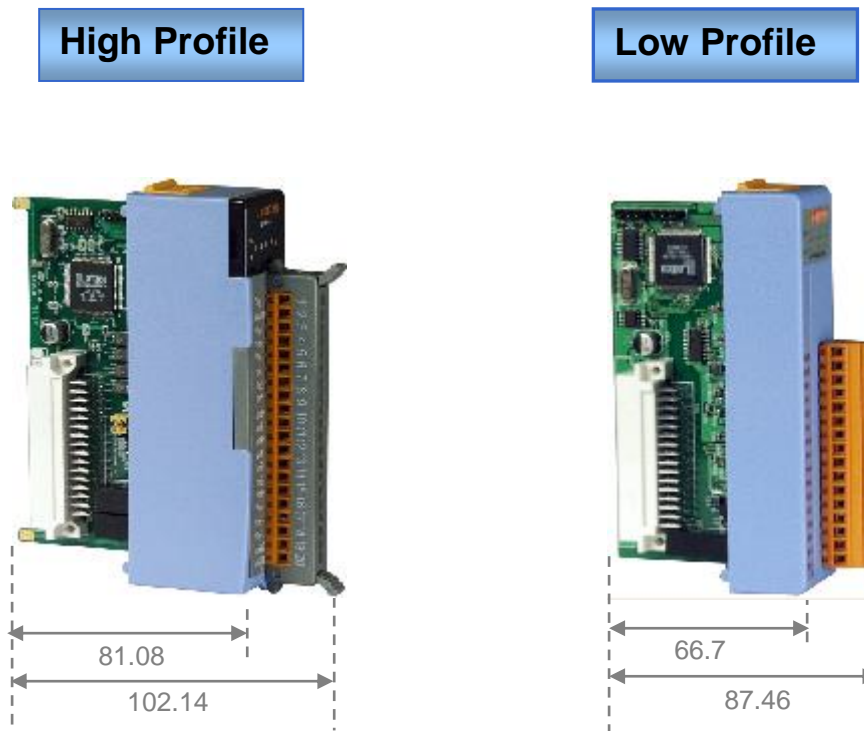

Fig. 26 : I-87K high/low profile series I/O modules

Please refer to web page :

http://www.icpdas.com/products/PAC/I-8000/8000_IO_modules.htm

Appendix C : Solution for 87K I/O module on the slot

When insert the module on the expansion slot of 87Pn, the same time 87Pn CPU will detect the module name and respond the status of interacting between 87Pn and module. As following diagram, the search result only find out the USB-87P4 and a 87019R which on slot 0, the Status column shows Auto Config. Enable [0,X,X,X]

Module	Address	Baudrate	Checksum	Format	Status	Description
USB-87P4	1[1]	115200	Disable	N,8,1	Auto Config. Enable [0,X,X,X]	Slot Auto Configuration USB Unit(DCON)
-87019R	2[2]	115200	Disable	N,8,1	87P4 Slot[0]	8*AI (Universal mA,mV,V,Thermocouple)(DCON)

Fig. 27 : The search result between 87Pn and modules

Click the name “USB-87P4” entering the operation screen to know the settings of 87Pn and the status detected by 87Pn CPU, the module status code in "Slot Configuration Slot" column means the different error message.

87P4 Hot Swap and Auto Configuration

I/O Write To 87P4	Addr.[Hex]	Slot Configuration Status	Set As Scanned	Write To 87P4
0 87019R	02	[00H] OK	Copy	Configure
1 87024	03	[06H] Can not find module	Copy	Configure
2 87055	04	[07H] Incorrect module name	Copy	Configure
3 Empty	05	[01H] Module scanned in Empty slot	Copy	Configure
4 -	-	-	Copy	Configure
5 -	-	-	Copy	Configure
6 -	-	-	Copy	Configure
7 -	-	-	Copy	Configure

Scanned I/O on Slot: 87019R, Empty, 87024, 87055, -, -, -, -

Buttons: Save Configuration, Load Configuration, Load Configuration And Write To 87P4, **Help**, Exit

Callout: You may click "Help" to inquire the solution and the meaning of error code.

Fig. 28 : DCON Utility shows the status of 87Pn expansion slot

As following table, you can accord the error code and LED lamp status to find out the problem solution.

Table 1 : The Error Code in Auto Config. Enable mode

Error Code	Slot LED (Red)	Status	Description	Solution
00H	Dark (ok)	OK	OK	None
01H	Flashing (Warning)	Module scanned in Empty Slot	1. There is a module scanned in this empty setting slot.	1. Remove the module
			2. The first time to setup, no initial value.	Reconfigure it with DCON Utility. 1. Click "Set As Scanned" button and configure module again 2. Click "Write To 87Pn" button to write settings to 87Pn.
02H	Flashing (Warning)	Commands not comparable	Configure failure:	1. Check the I-87K I/O module's firmware.
			This is a 87K I/O module firmware compatibility problem . Some commands at this slot might be too new for this old firmware of 87K I/O module, but it is not serious for system operation.	* Run Dcon Utility→Terminal→Dcon command Line→ setup Baud Rate→Command: \$AAF (EX. 01F) →Send * You can see the version, Respond=!01A1.9 2. Update the 87K I/O module with a new firmware version.
03H	Bright (Error)	Configuration Failed	Configure failure:	1. Check the 87K I/O module firmware
			Some commands are not supported by this 87K I/O module and this error will be serious for system operation.	2. Update the 87K I/O module with a new firmware version.
04H	Bright (Error)	wrong Configuration format	Configure failure:	1. Run DCON Utility.
			The format of configured commands is wrong for DCON Protocol.	2. Click the "Write To 87Pn" button to write the settings to 87Pn CPU again.
05H	Bright	Read	The memory data is failed:	1. Run DCON Utility.

	(Error)	Configuration failed	The configured commands are wrong for DCON Protocol.	2. Click the "Write To 87Pn" button to write the settings to 87Pn CPU again.
06H	Bright (Error)	Can not find module	The configured module at this slot has been removed. It is empty now.	1. Please insert a correct module as previous configured one. 2. Or configure with DCON Utility as "Empty" and click the "Write To 87Pn" button to write the configuration to 87Pn CPU.
07H	Bright (Error)	Incorrect module name	Configure failure:	The insert & configure module name are different, insert the correct one or run the Dcon Utility to modify the settings accord with the module name.
			The module inserted in this slot is not the same as previous configured.	
08H	Bright (Error)	Internal INIT* pin failed	Configure failure:	1. Please restart the power to initialize to I/O module 2. If it still failed to initialize, send it back to factory to check. Note: USB-87Pn only supports high profile 87K I/O modules.
			The INIT Pin is failed to connect with the GND and module failed to initialize.	
09H	Bright (Error)	Module address over 255 (FFh)	The module address is over 255 (FFh).	The maximum address of 87P1 is 254 (FEh) 87P2 is 253 (FDh) 87P4 is 251 (FBh) 87P8 is 247 (F7h)
0AH	Bright (Error)	The command count saved to 87Pn is not the same as DCON Utility	This error might be caused by following reasons. 1. Command length error. 2. Command checksum error. 3. Communication error during the process of writing commands to 87Pn.	Please configure this 87K I/O module with DCON Utility, and click the "Write To 87Pn" button to write the configuration to 87Pn CPU again.

OBH	Bright (Error)	Module response failed	This error might be caused by following reasons. Module response failed above 5 times.	Please restart the power to initialize to I/O module, or configure this 87K I/O module with DCON Utility, and click the "Write To 87Pn" If I/O module often becomes 0xBh error, it may something caused communication failed between 87Pn and I/O module. User can send ~AARCxx command to set XX second to reset I/O module when 0xBH error appears. (XX range is 0~ 0xFF ,can be set 0~256 second)
OCH	Bright (Error)	Module name invalid	The module inserted in this slot is not the same as previous configured.	Module is not 87K high profile I/O modules. Note:87Pn only supports 87K high profile I/O modules, Please replace it as 87K I/O module
ODH	Bright (Error)	Module Init command invalid	This error might be caused by command not complete on I/O module	Reconfigure it with DCON Utility. 1. Click "Set As Scanned" button and configure module again 2. Click "Write To 87Pn" button to write settings to 87Pn.

Table 2 : The Error Code in Auto Config. Disable mode

Error Code	Slot LED (Red)	Status	Description	Solution
80H	Dark (ok)	Initialize ok	setup success	None
81H	Bright (Error)	Internal INIT* pin failed	The INIT Pin is failed to connect with the GND and module failed to initialize.	If it still fails after restart the 87Pn many times, please send the 87K I/O module back to factory to check.
82H	Bright (Error)	Module address over 255 (FFh)	The module address is over 255 (FFh).	The maximum address of 87P1 is 254 (FEh) 87P2 is 253 (FDh) 87P4 is 251 (FBh) 87P8 is 247 (F7h)

You can see the LED signals on 87Pn CPU module to know whether the 87Pn is operating properly. Please refer to appendix.

	Auto Config. LED (Green)	S.RDY LED (Green)	Slot Status LED (Red)
Auto Config. Enable			
No Error	Always ON	Always ON	Always OFF
Warning		Always ON	Flash
Failed		Flash	Always ON
Auto Config. Disable			
No Error	Always OFF	Always ON	Always OFF
Failed		Flash	Always ON

Appendix D: Description For ini Files

While you save the configuration file, the DCON Utility will save as .ini file. The default path of file as below:

C:\ICPDAS\DCON_Utility\for_users

The INI file explains as follows:

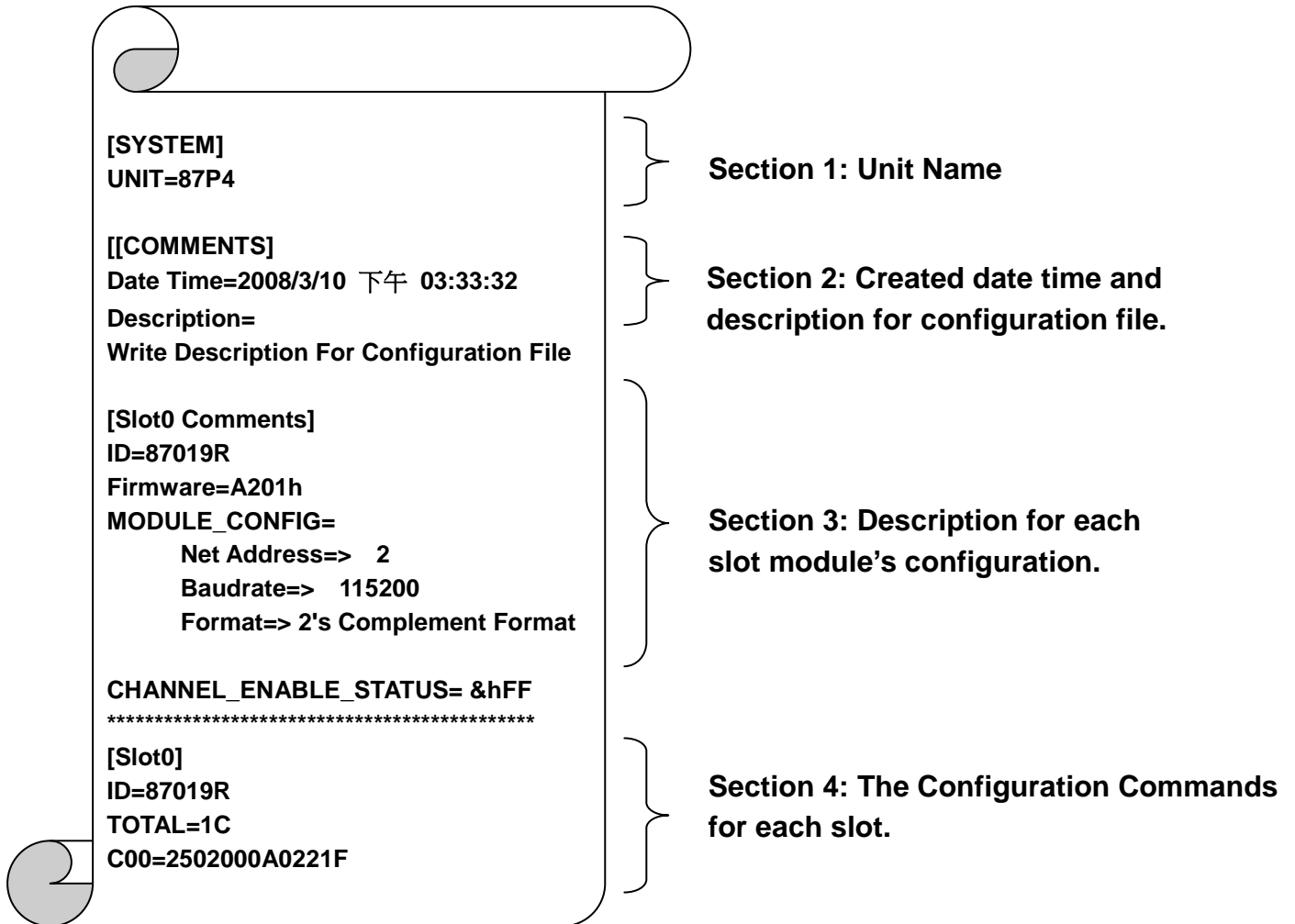

Appendix E: Frame Ground

Electronic circuits are constantly vulnerable to Electro-Static Discharge (ESD), which become worse in a continental climate area. Some I-7000, M-7000 and I-8000 series modules feature a new design for the frame ground, which provides a path for bypassing ESD, allowing enhanced static protection (ESD) capability and ensures that the module is more reliable.

The following options will provide a better protection for the module:

The USB-87Pn controller has a metallic board attached to the back of the plastic basket. When mounted to the DIN rail, connect the DIN rail to the earth ground because the DIN rail is in contact with the upper frame ground as shown in the Figure 29 below

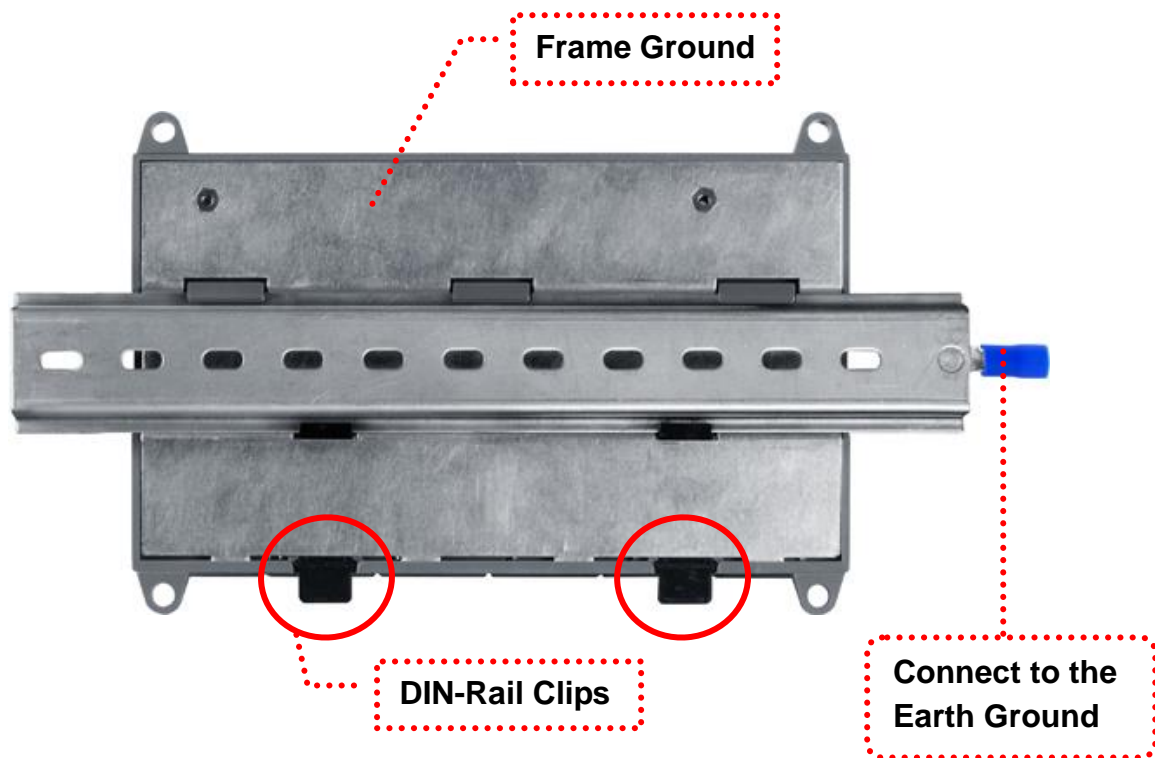

Fig. 29 : Frame Ground & Earth Ground