

Moxa AirWorks AWK-5232

Quick Installation Guide

Second Edition, May 2014



© 2014 Moxa Inc. All rights reserved.

P/N: 1802052320011

Overview

The AWK-5232 802.11 a/b/g/n dual-RF wireless AP/Bridge/Client provides a flexible and highly reliable solution for your industrial wireless networks.

The AWK-5232 is rated to operate at temperatures ranging from 0 to 60°C for standard models and -40 to 75°C for extended temperature models, and it is rugged enough for industrial applications.

With two independent RF modules, the AWK-5232 supports a greater variety of wireless configurations and applications, and the redundant wireless connections increase the reliability of your entire wireless network.

The AWK-5232's two DC power inputs make the power supply more reliable, and it can also be powered via PoE for easier deployment.

Package Checklist

Moxa's AWK-5232 is shipped with the following items. If any of these items is missing or damaged, please contact your customer service representative for assistance.

- 1 AWK-5232
- 4 Swivel-type Antennas (2dBi, RP-SMA, 2.4&5GHz)
- 1 Quick Installation Guide
- 1 Software CD
- 1 Moxa Product Warranty Booklet
- 1 Cable Holder with a Screw
- 2 Protective Caps

Installation and Configuration

Before installing the AWK-5232, make sure that all items in the Package Checklist are in the box. In addition, you will need access to a notebook computer or PC equipped with an Ethernet port. The AWK-5232 has a default IP address that you must use when connecting to the device for the first time.

Step 1: Select the power source

The AWK-5232 can be powered by a DC power input or PoE+ (Power over Ethernet). The AWK-5232 will use whichever power source you choose.



ATTENTION

Do not use IEEE802.3af PoE Injector or PSE (Power Sourcing Equipment). Use IEEE802.3at-compliant PSE for PoE+ (Power over Ethernet) device.

Step 2: Connect the AWK-5232 to a notebook or PC

Since the AWK-5232 supports MDI/MDI-X auto-sensing, you can use either a straight-through cable or crossover cable to connect the AWK-5232 to a computer. If the LED indicator on the AWK-5232's LAN port lights up, it means the connection is established.

Step 3: Set up the computer's IP address

Set an IP address on the same subnet as the AWK-5232. Since the AWK-5232's default IP address is 192.168.127.253, and the subnet mask is 255.255.255.0, you should set the IP address of the computer to 192.168.127.xxx and subnet mask to 255.255.255.0.

Step 4: Use the web-based manager to configure AWK-5232

Open your computer's web browser and then type <http://192.168.127.253> in the address field to access the homepage of the web-based management. Before the homepage opens, you will need to enter the user name and password. For first-time configuration, enter the default user name and password and then click on the Login button:

- User name: **admin**
- Password: **root**



ATTENTION

For security reasons, we strongly recommend changing the password. To do so, select **Maintenance → Password**, and then follow the on-screen instructions.

Step 5: Select the operation mode for the AWK-5232

By default, the AWK-5232's operation mode is set to Wireless Redundancy. You can change the setting in **Wireless Settings → Operation mode** if you would like to use the Wireless Bridge or AP-Client mode.

NOTE To make the change effective, you must click **Save Configuration** to save the change or **Restart → Save and Restart** button to apply all changes.

Panel Layout of the AWK-5232

Top Panel View

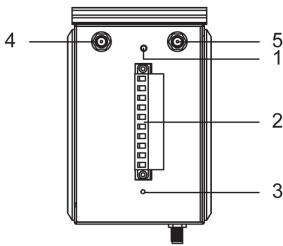

1. Grounding screw
2. Terminal block for PWR1, PWR2, relay, DI1, and DI2
3. Reset button
4. 1B antenna port (1A and 1B are shared same RF module)
5. 2B antenna port (2A and 2B are shared same RF module)

Front Panel View

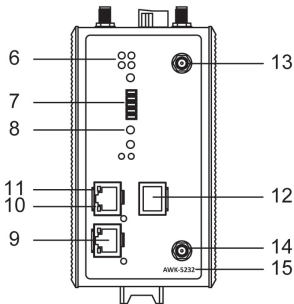

6. System LEDs: PWR1, PWR2, PoE+, FAULT, and STATE LEDs
7. LEDs for signal strength
8. WLAN LEDs: WLAN 1 and WLAN2 LEDs
9. 10/100/1000BaseT(X) RJ45 Port : LAN1 and LAN2
10. 100M LED
11. 1000M LED
12. RS-232 console port
13. MAIN 1A antenna port
14. MAIN 2A antenna port
15. Model name
16. Screw hole for wall mounting kit
17. DIN-Rail mounting kit

Rear Panel View

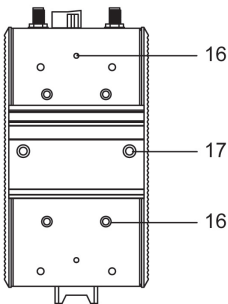

Mounting Dimensions

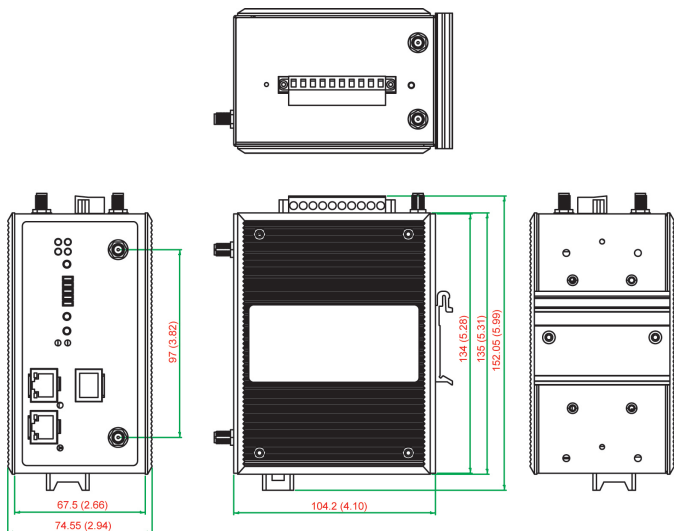

Unit = mm (inch)

DIN-Rail Mounting

The aluminum DIN-Rail attachment plate should be fixed to the back panel of the AWK-5232 when you take it out of the box. If you need to reattach the DIN-Rail attachment plate to the AWK-5232, make sure the stiff metal spring is situated towards the top, as shown in the figures below.

STEP 1:

Insert the top of the DIN-Rail into the slot just below the stiff metal spring.

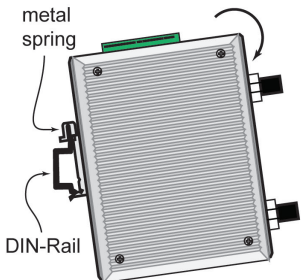

STEP 2:

The DIN-Rail attachment unit will snap into place as shown below.

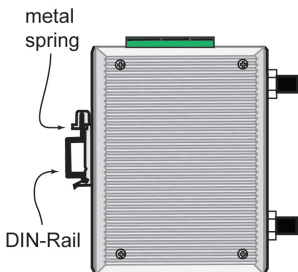

To remove the AWK-5232 from the DIN-Rail, simply reverse Steps 1 and 2.

Wall Mounting (optional)

For transportation applications that require an EN50155 certification report, you should purchase the optional wall mount for the AWK-5232, since the wall mount has passed EN50155 testing. The wall mount is also convenient for other applications that require mounting the AWK-5232 to a wall.

STEP 1:

Remove the aluminum DIN-Rail attachment plate from the AWK-5232, and then attach the wall mount plates with **M3** screws, as shown in the adjacent diagrams.

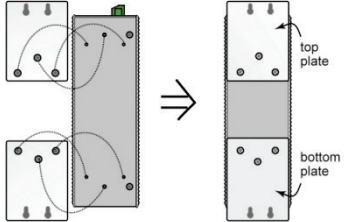

STEP 2:

Mounting the AWK-5232 to a wall requires 4 screws. Use the AWK-5232 device, with wall mount plates attached, as a guide to mark the correct locations of the 4 screws. The heads of the screws should be less than 6.0 mm in diameter, and the shafts should be less than 3.5 mm in diameter, as shown in the figure at the right.

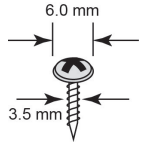

Do not screw the screws in all the way—leave a space of about 2 mm to allow room for sliding the wall mount panel between the wall and the screws.

STEP 3:

Once the screws are fixed into the wall, insert the four screw heads through the large opening of the keyhole-shaped apertures, and then slide the AWK-5232 downwards, as indicated to the right. Tighten the four screws for added stability.

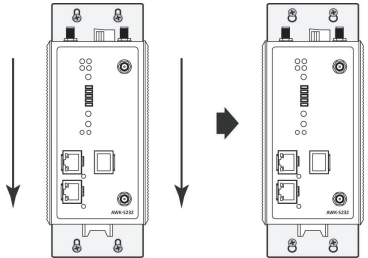

WARNING

- This equipment is intended to be used in a Restricted Access Location, such as a dedicated computer room. Access can only be gained by SERVICE PERSONS or by USERS who have been instructed about the fact that the metal chassis of the equipment is extremely hot and may cause burns.
- Service persons or users have to pay special attention and take special precaution before handling the equipment.
- Access is to be controlled through the use of a lock and key or a security identity system, controlled by the authority responsible for the location. Only authorized, well-trained professionals are allowed to access the restricted access location.
- External metal parts are hot!! Pay special attention or use special protection before handling..

Wiring Requirements



WARNING

Safety First!

Be sure to disconnect the power cord before installing and/or wiring your Moxa AWK-5232.



WARNING

Safety First!

Calculate the maximum possible current in each power wire and common wire. Observe all electrical codes dictating the maximum current allowed for each wire size.

If the current goes above the maximum ratings, the wiring could overheat, causing serious damage to your equipment.

You should also pay attention to the following items:

- Use separate paths to route wiring for power and devices. If power wiring and device wiring paths must cross, make sure the wires are perpendicular at the intersection point.
NOTE: Do not run signal or communications wiring and power wiring in the same wire conduit. To avoid interference, wires with different signal characteristics should be routed separately.
- You can use the type of signal transmitted through a wire to determine which wires should be kept separate. The rule of thumb is that wiring with similar electrical characteristics can be bundled together.
- Keep input wiring and output wiring separate.
- It is strongly advised that you label wiring to all devices in the system when necessary.



ATTENTION

This product is intended to be supplied by a Listed Power Unit marked "Class 2" or "LPS" and rated O/P: 12 to 48 VDC, max 800 mW, 25°C.



ATTENTION

Make sure the external power adaptor (includes power cords and plug assemblies) provided with the unit is certified and suitable for use in your country.

Grounding the Moxa AWK-5232

Grounding and wire routing help limit the effects of noise due to electromagnetic interference (EMI). Run the ground connection from the ground screw to the grounding surface prior to connecting devices.



ATTENTION

This product is intended to be mounted to a well-grounded mounting surface, such as a metal panel.

Wiring the Redundant Power Inputs

The top two pairs of contacts of the 10-contact terminal block connector on the AWK-5232's top panel are used for the AWK-5232's two DC inputs. Top and front views of the terminal block connector is shown here.

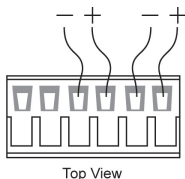

STEP 1: Insert the negative/positive DC wires into the V-/V+ terminals.

STEP 2: To keep the DC wires from pulling loose, use a small flat-blade screwdriver to tighten the wire-clamp screws on the front of the terminal block connector.

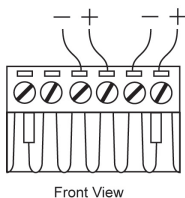

STEP 3: Insert the plastic terminal block connector prongs into the terminal block receptor, which is located on the AWK-5232's top panel.



ATTENTION

Before connecting the AWK-5232 to the DC power inputs, make sure the DC power source voltage is stable.

Wiring the Relay Contact

The AWK-5232 has one relay output, which consists of the two contacts of the terminal block on the AWK-5232's top panel. Refer to the previous section for detailed instructions on how to connect the wires to the terminal block connector, and how to attach the terminal block connector to the terminal block receptor. These relay contacts are used to indicate user-configured events. The two wires attached to the Relay contacts form an open circuit when a user-configured event is triggered. If a user-configured event does not occur, the Relay circuit will be closed.

Wiring the Digital Inputs

The AWK-5232 has two sets of digital input—DI1 and DI2. Each DI comprises two contacts of the 10-pin terminal block connector on the AWK-5232's top panel. You can refer to the "Wiring the Redundant Power Inputs" section for detailed instructions on how to connect the wires to the terminal block connector, and how to attach the terminal block connector to the terminal block receptor.

Cable Holder Installation

You can attach the cable holder to the bottom of the AWK-5232. This helps to keep cabling neat and avoid accidents that result from untidy cables.

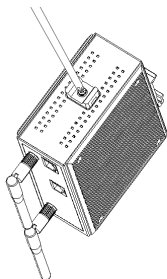

STEP 1: Screw the cable holder onto the bottom of the AWK-5232.

STEP 2: After mounting the AWK-5232 and plugging in the LAN cable, tighten the cable along the device and wall.

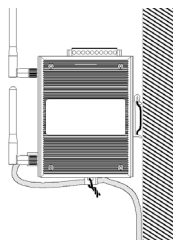
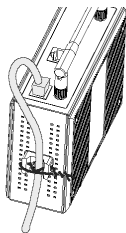
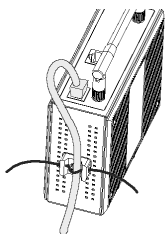

Communication Connections

10/100BaseT(X) Ethernet Port Connection

The 10/100BaseT(X) ports located on the AWK-5232's front panel are used to connect to Ethernet-enabled devices.

Below we show pinouts for both MDI (NIC-type) ports and MDI-X (HUB/Switch-type) ports.

MDI Port Pinouts

MDI-X Port Pinouts

8-pin RJ45

Pin	Signal	Pin	Signal
1	Tx+	1	Rx+
2	Tx-	2	Rx-
3	Rx+	3	Tx+
6	Rx-	6	Tx-

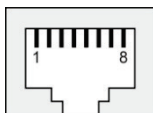

1000BaseT Ethernet Port Connection

1000BaseT data is transmitted on differential TRD+/- signal pairs over copper wires.

MDI/MDI-X Port Pinouts for 8-pin RJ45

Pin	Signal
1	TRD(0)+
2	TRD(0)-
3	TRD(1)+
4	TRD(2)+
5	TRD(2)-
6	TRD(1)-
7	TRD(3)+
8	TRD(3)-

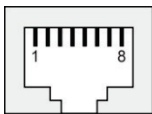

RS-232 Connection

The AWK-5232 has one RS-232 (8-pin RJ45) console port located on the front panel. Use either an RJ45-to-DB9 or RJ45-to-DB25 cable to connect the Moxa AWK-5232's console port to your PC's COM port. You may then use a console terminal program to access the AWK-5232 for console configuration.

Console Pinouts for 10-pin or 8-pin RJ45

10-Pin	Description	8-Pin
1	-----	
2	DSR	1
3	RTS	2
4	GND	3
5	TxD	4
6	RxD	5
7	DCD	6
8	CTS	7
9	DTR	8
10	-----	

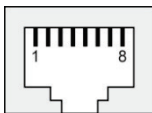

NOTE The pin numbers for male DB9 and DB25 connectors, and hole numbers for female DB9 and DB25 connectors are labeled on the connector. However, the numbers are typically quite small, so you may need to use a magnifying glass to see the numbers clearly.

The pin numbers for both 8-pin and 10-pin RJ45 connectors (and ports) are typically not labeled on the connector (or port). Refer to the Pinout diagram above to see how RJ45 pins are numbered.

LED Indicators

The front panel of the Moxa AWK-5232 contains several LED indicators. The function of each LED is described in the table below.

LED	Color	State	Description
Front Panel LED Indicators (System)			
PWR1	Green	On	Power is being supplied from power input 1.
		Off	Power is not being supplied from power input 1.
PWR2	Green	On	Power is being supplied from power input 2.
		Off	Power is not being supplied from power input 2.
PoE+	Amber	On	Power is being supplied via PoE.
		Off	Power is not being supplied via PoE.
FAULT	Red	Blinking	Cannot get an IP address from the DHCP server (interval: 1 sec)
		Off	There is no error condition.
STATE	Green/ Red	Green	Software Ready.
		Blinking Green	The AWK has been located by AWK Search Utility (interval: 1sec)
		Red	Booting or Error condition.
WLAN1	Green/ Amber	Green On	WLAN1 functions in Client mode.
		Blinking Green	WLAN1's data communication is running in Client mode.
		Amber On	WLAN1 functions in AP/Bridge mode.
		Blinking Amber	WLAN1's data communication is running in AP/Bridge mode.
		Off	WLAN1 is not in use.
WLAN2	Green/ Amber	Green On	WLAN2 function is in Client mode.
		Blinking Green	WLAN2's data communication is running in Client mode.
		Amber On	WLAN2 function is in AP/Bridge mode.
		Blinking Amber	WLAN2's data communication is running in AP/Bridge mode.
		Off	WLAN2 is not in use.
TP Port (LAN1, LAN2) LED Indicators (Port Interface)			
100M	Yellow	On	TP port's 100 Mbps link is active.
		Blinking	Data is being transmitted at 100 Mbps
		Off	TP port's 100 Mbps link is inactive.
1000M	Green	On	TP port's 1000 Mbps link is active.
		Blinking	Data is being transmitted at 1000 Mbps
		Off	TP port's 1000 Mbps link is inactive.

Specifications

WLAN Interface

Standards:

IEEE 802.11a/b/g/n for Wireless LAN
IEEE 802.11i for Wireless Security
IEEE 802.3 for 10BaseT
IEEE 802.3u 100BaseTX
IEEE 802.3ab for 1000BaseT
IEEE 802.3at for Power-over-Ethernet
IEEE 802.1D for Spanning Tree Protocol
IEEE 802.1w for Rapid STP
IEEE 802.1Q VLAN

Spread Spectrum and Modulation (typical):

- DSSS with DBPSK, DQPSK, CCK
- OFDM with BPSK, QPSK, 16QAM, 64QAM
- 802.11b: CCK @ 11/5.5 Mbps, DQPSK @ 2 Mbps, DBPSK @ 11 Mbps
- 802.11a/g: 64QAM @ 54/48 Mbps, 16QAM @ 36/24 Mbps, QPSK @ 18/12 Mbps, BPSK @ 9/6 Mbps
- 802.11n: 64QAM @ 300 Mbps to BPSK @ 6.5 Mbps (multiple rates supported)

Operating Channels (central frequency):

US:

2.412 to 2.462 GHz (11 channels)

5.18 to 5.24 GHz (4 channels)

EU:

2.412 to 2.472 GHz (13 channels)

5.18 to 5.24 GHz (4 channels)

JP:

2.412 to 2.472 GHz (13 channels, OFDM)

2.412 to 2.484 GHz (14 channels, DSSS)

5.18 to 5.24 GHz (4 channels for W52)

Security:

- SSID broadcast enable/disable
- Firewall for MAC/IP/Protocol/Port-based filtering
- 64-bit and 128-bit WEP encryption, WPA /WPA2-Personal and Enterprise (IEEE 802.1X/RADIUS, TKIP and AES)

Transmission Rates:

802.11b: 1, 2, 5.5, 11 Mbps

802.11a/g: 6, 9, 12, 18, 24, 36, 48, 54 Mbps

802.11n: 6 to 300 Mbps (multiple rates supported)

TX Transmit Power:

802.11b:

1 to 11 Mbps: Typ. 18 dBm (± 1.5 dBm)

802.11g:

6 to 24 Mbps: Typ. 18 dBm (± 1.5 dBm)

36 to 48 Mbps: Typ. 17 dBm (± 1.5 dBm)

54 Mbps: Typ. 15 dBm (± 1.5 dBm)

802.11a:

6 to 24 Mbps: Typ. 17 dBm (± 1.5 dBm)

36 to 48 Mbps: Typ. 16 dBm (± 1.5 dBm)

54 Mbps: Typ. 14 dBm (± 1.5 dBm)

TX Transmit Power MIMO:

802.11a/n (20/40 MHz):

MCS15 20 MHz: Typ. 13 dBm (± 1.5 dBm)

MCS15 40 MHz: Typ. 12 dBm (± 1.5 dBm)

802.11g/n (20/40 MHz):

MCS15 20 MHz: Typ. 14 dBm (± 1.5 dBm)

MCS15 40 MHz: Typ. 13 dBm (± 1.5 dBm)

RX Sensitivity:

802.11b:

-92 dBm @ 1 Mbps, -90 dBm @ 2 Mbps, -88 dBm @ 5.5 Mbps, -84 dBm @ 11 Mbps

802.11g:

-87 dBm @ 6 Mbps, -86 dBm @ 9 Mbps, -85 dBm @ 12 Mbps, -82 dBm @ 18 Mbps, -80 dBm @ 24 Mbps, -76 dBm @ 36 Mbps, -72 dBm @ 48 Mbps, -70 dBm @ 54 Mbps

802.11a:

-87 dBm @ 6 Mbps, -86 dBm @ 9 Mbps, -85 dBm @ 12 Mbps, -82 dBm @ 18 Mbps,

-80 dBm @ 24 Mbps, -76 dBm @ 36 Mbps, -72 dBm @ 48 Mbps, -70 dBm @ 54 Mbps

RX Sensitivity MIMO:

802.11a/n:

-68 dBm @ MCS15 40 MHz, -70 dBm @ MCS7 40 MHz, -69 dBm @ MCS15 20 MHz, -71 dBm @ MCS7 20 MHz

802.11g/n:

-68 dBm @ MCS15 40 MHz, -70 dBm @ MCS7 40 MHz, -69 dBm @ MCS15 20 MHz, -71 dBm @ MCS7 20 MHz

Protocol Support

General Protocols: Proxy ARP, DNS, HTTP, HTTPS, IP, ICMP, SNTP, TCP, UDP, RADIUS, SNMP, PPPoE, DHCP, LLDP

AP-only Protocols: ARP, BOOTP, DHCP, STP/RSTP (IEEE 802.1D/w)

Interface

Default Antennas: 4 dual-band omni-directional antennas, 2 dBi, RP-SMA (male)

Connector for External Antennas: RP-SMA (female)

LAN Ports: 2, 10/100/1000BaseT(X), auto negotiation speed (RJ45-type)

Console Port: 1, RS-232 (RJ45-type)

LED Indicators: PWR1, PWR2, PoE+, FAULT, STATE, WLAN1, WLAN2, 100M, 1000M

Alarm Contact (Digital Output): 1 relay output with current carrying capacity of 1 A @ 24 VDC

Digital Inputs: 2 electrically isolated inputs

- +13 to +30 V for state "1"
- +3 to -30 V for state "0"
- Max. input current: 8 mA

Physical Characteristics

Housing: Metal, IP30 protection

Weight: 1.2 Kg

Dimensions: 74.55 x 135 x 105 mm (2.94 x 5.31 x 4.13 in)

Installation: DIN-Rail mounting (standard), wall mounting (optional)

Environmental Limits

Operating Temperature:

Standard Models: 0 to 60°C (32 to 140°F)

Wide Temp. Models: -40 to 75°C (-40 to 167°F)

Storage Temperature: -40 to 85°C (-40 to 185°F)

Ambient Relative Humidity: 5% to 95% (non-condensing)

Power Requirements

Input Voltage: 12 to 48 VDC, redundant dual DC power inputs or 48 VDC Power-over-Ethernet (IEEE 802.3af compliant)

Connector: 10-pin removable terminal block

Power Consumption: 12 to 48 VDC, 1.5 A (max.)

Reverse Polarity Protection: Present

Standards and Certifications

Safety: UL 60950-1, EN 60950-1

EMC: EN 301 489-1/17, FCC Part 15 Subpart B Class B, EN 55022/55024, IEC 61000-6-2/4

Radio: EN 300 328, EN 301 893

Rail Traffic: EN 50155, EN 50121-1/4

Note: Please check Moxa's website for the most up-to-date certification status.

Reliability

MTBF (mean time between failures): 290,422 hrs

Warranty

Warranty Period: 5 years

Details: See www.moxa.com/warranty



ATTENTION

The AWK-5232 is **NOT** a portable mobile device and should be located at least 20 cm away from the human body. The AWK-5232 is **NOT** designed for the general public. To deploy AWK-5232s and establish a wireless network safely, a well-trained technician is required for installation.



ATTENTION

Use the antennas correctly: Two dual-band 2.4 GHz & 5 GHz antennas are included with the product. Either antenna can be installed in MAIN1 or MAIN2. If you want to use a single band antenna, please use 2.4 GHz antennas for IEEE 802.11b/g mode and 5 GHz antennas for IEEE 802.11a mode. In order to improve the quality of the signal received by the Main antennas, you may connect additional antennas to AUX1 and AUX2.



ATTENTION

This device complies with part 15 of the FCC Rules. Operation is subject to the following two conditions:

- (1) This device may not cause harmful interference, and
- (2) This device must accept any interference received, including interference that may cause undesired operation.



ATTENTION

Do not locate the antenna near overhead power lines or other electric light or power circuits, or where it can come into contact with such circuits. When installing the antenna. Take extreme care not to come into contact with such circuits, because they may cause serious injury or death. For proper installation and grounding of the antenna. please refer to national and local codes (for example, U.S.:NFPA 70, National Electrical Code, Article 810, Canada: Canadian Electrical Code, Section 54).

Technical Support Contact Information www.moxa.com/support

Moxa Americas:

Toll-free: 1-888-669-2872

Tel: 1-714-528-6777

Fax: 1-714-528-6778

Moxa China (Shanghai office):

Toll-free: 800-820-5036

Tel: +86-21-5258-9955

Fax: +86-21-5258-5505

Moxa Europe:

Tel: +49-89-3 70 03 99-0

Fax: +49-89-3 70 03 99-99

Moxa Asia-Pacific:

Tel: +886-2-8919-1230

Fax: +886-2-8919-1231