

EDS-518E Series Hardware Installation Guide

Moxa EtherDevice™ Switch

First Edition, December 2014

P/N: 1802005180020

Package Checklist

The EDS-518E is shipped with the following items. If any of these items are missing or damaged, please contact your customer service representative for assistance.

- 1 EDS-518E Ethernet switch
- USB cable
- Protective caps for unused ports
- Hardware installation guide
- Documentation and software CD
- Moxa product warranty statement

Features

- 4 Gigabit combo Ethernet ports plus 14 Fast Ethernet ports for copper and fiber
- Turbo Ring and Turbo Chain (recovery time < 20 ms @ 250 switches), RSTP/STP, and MSTP for network redundancy
- RADIUS, TACACS+, SNMPv3, IEEE 802.1x, HTTPS, and SSH to enhance network security
- EtherNet/IP, PROFINET, and Modbus/TCP protocols supported for device management and monitoring

Panel Views of EDS-518E

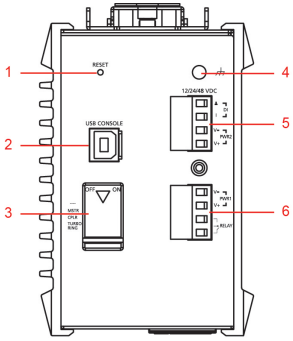

1. Reset button
2. USB console port
3. DIP switches for Turbo Ring, Ring Master, and Ring Coupler
4. Grounding screw
5. 4-pin terminal block for digital input and power input 2
6. 4-pin terminal block for relay output and power input 1
7. 10/100BaseT(X) port, ports 1 to 14
8. 100BaseT(X) LED indicator
9. 10BaseT(X) LED indicator
10. System status LED:
 - STATE LED indicator
 - PWR1 LED indicator
 - PWR2 LED indicator
 - FAULT LED indicator
 - MSTR/HEAD LED indicator
 - CPLR/TAIL LED indicator

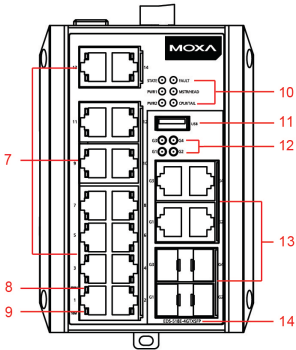

11. USB storage port
12. G1 to G4 ports LED indicator
13. 10/100/1000BaseT(X) or 100/1000BaseSFP combo port, ports G1 to G4
14. Model Name
15. Screw hole for Wall Mounting Kit
16. DIN-Rail Kit

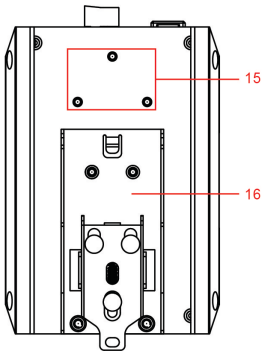

Panel Views of EDS-518E (SC/ST Type)

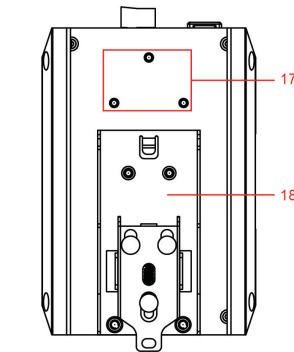
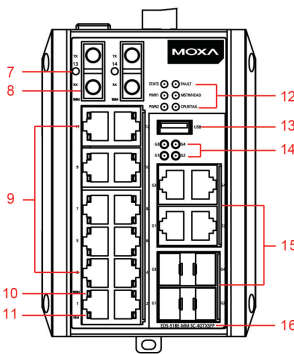
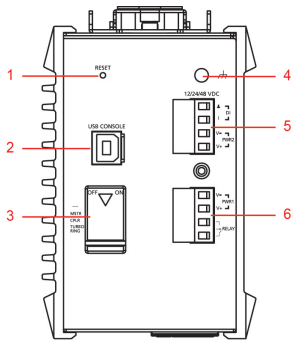

NOTE:

The appearance of EDS-518E-SS-SC is identical to EDS-518E-MM-SC. The appearance of EDS-518E-MM-ST is identical to EDS-518E-MM-SC.

1. Reset button
2. USB console port
3. DIP switches for Turbo Ring, Ring Master, and Ring Coupler
4. Grounding screw
5. 4-pin terminal block for digital input and power input 2
6. 4-pin terminal block for relay output and power input 1
7. 100BaseFX port LED indicator: 13, 14
8. 100BaseFX port (SC type), ports 13, 14
9. 10/100BaseT(X) port, ports 1 to 12
10. 100BaseT(X) LED indicator
11. 10BaseT(X) LED indicator
12. System status LED:
 - STATE LED indicator
 - PWR1 LED indicator
 - PWR2 LED indicator
 - FAULT LED indicator
 - MSTR/HEAD LED indicator
 - CPLR/TAIL LED indicator
13. USB storage port
14. G1 to G4 ports LED indicator
15. 10/100/1000BaseT(X) or 100/1000BaseSFP combo port, ports G1 to G4
16. Model Name
17. Screw hole for Wall Mounting Kit
18. DIN-Rail Kit

Mounting Dimensions

Unit = mm (inch)

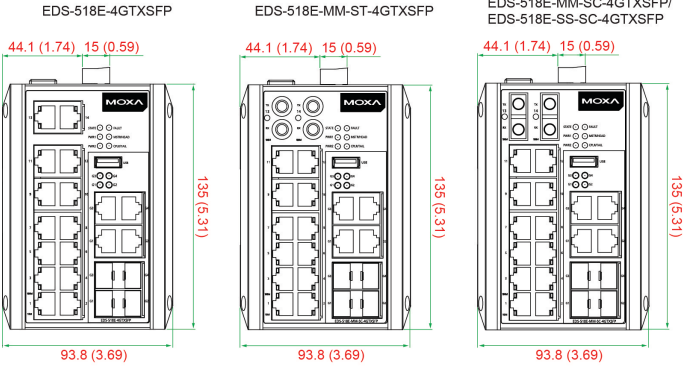

Front Views

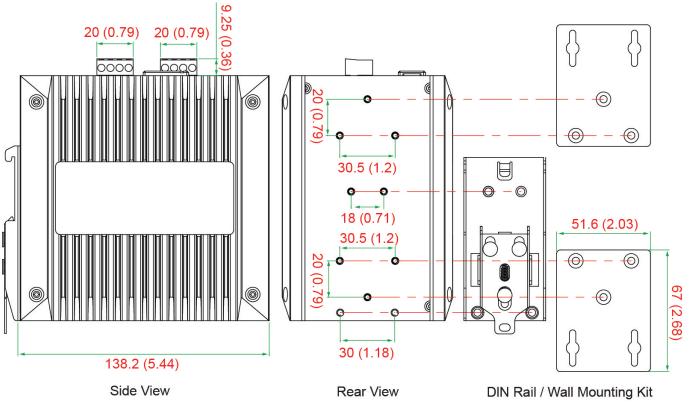

DIN-Rail Mounting

The metal DIN-rail kit is fixed to the back panel of the EDS-518E when you take it out of the box. Mount the EDS-518E on corrosion-free mounting rails that meet the EN 60715 standard.

Installation

STEP 1: Insert the upper lip of the DIN rail into the DIN-rail mounting kit.

STEP 2: Press the EDS-518E series towards the DIN rail until it snaps into place.

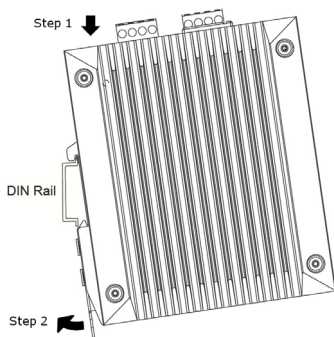

Removal

STEP 1: Pull down the latch on the mounting kit with a screwdriver.

STEPS 2 & 3: Pull the EDS-518E forward slightly and then lift up to remove it from the DIN rail.

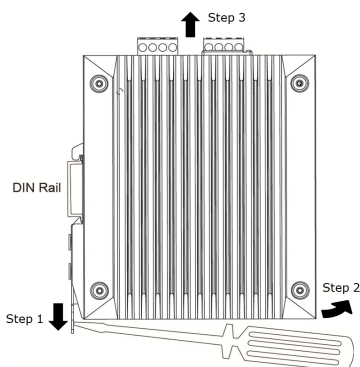

ATTENTION

1. These devices are open-type devices that are to be installed in an enclosure with tool removable cover or door suitable for the environment at that location.
2. This equipment is suitable for use in Class I, Division 2, Groups A, B, C, and D or non-hazardous locations only.

Wall Mounting (Optional)

For some applications, you will find it convenient to mount the Moxa EDS-518E on a wall, as shown in the following illustrations:

STEP 1: Remove the aluminum DIN-rail attachment plate from the rear panel of the EDS-518E, and then attach the wall mount plates with M3 screws, as shown in the figure at the right.

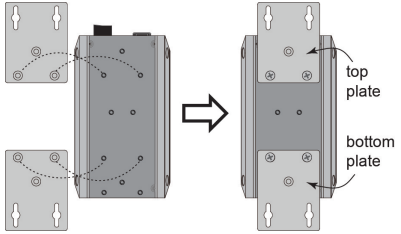

STEP 2: Mounting the EDS-518E series on a wall requires 4 screws. Use the EDS-518E, with wall mount plates attached, as a guide to mark the correct locations of the 4 screws. The heads of the screws should be less than 6.0 mm in diameter, and the shafts should be less than 3.5 mm in diameter, as shown in the figure on at the right.

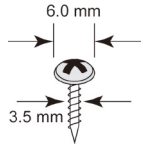

NOTE Before tightening the screws into the wall, make sure the screw head and shank size are suitable by inserting the screw through one of the keyhole-shaped apertures of the wall mount plates.

Do not screw the screws in all the way—leave about 2 mm to allow room for sliding the wall mount panel between the wall and the screws.

STEP 3: Once the screws are fixed to the wall, insert the four screw heads through the wide parts of the keyhole-shaped apertures, and then slide the EDS-518E downwards, as indicated in the figure at the right. Tighten the four screws for greater stability.

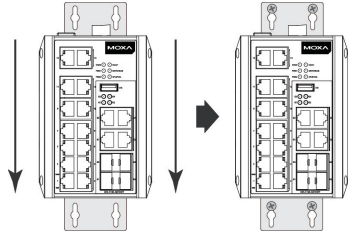

WARNING

1. EXPLOSION HAZARD—Do not disconnect equipment unless power has been removed or the area is known to be non-hazardous.
2. EXPLOSION HAZARD—Substitution of any components may impair suitability for Class I, Division 2.
3. EXPOSURE TO SOME CHEMICALS MAY DEGRADE THE SEALING PROPERTIES OF MATERIALS USED IN THE RELAY.

Wiring Requirements



WARNING

Do not disconnect modules or wires unless power has been switched off or the area is known to be non-hazardous. The devices may only be connected to the supply voltage shown on the type plate. The devices are designed for operation with a Safety Extra-Low Voltage. Thus, they may only be connected to the supply voltage connections and to the signal contact with the Safety Extra-Low Voltages (SELV) in compliance with IEC950/EN60950/ VDE0805.



ATTENTION

This unit is a built-in type. When the unit is installed in another piece of equipment, the equipment enclosing the unit must comply with fire enclosure regulation IEC 60950/EN60950 (or similar regulation).



ATTENTION

Safety First!

Be sure to disconnect the power cord before installing and/or wiring your EDS-518E.

Calculate the maximum possible current in each power wire and common wire. Observe all electrical codes dictating the maximum current allowable for each wire size.

If the current goes above the maximum ratings, the wiring could overheat, causing serious damage to your equipment.

Please read and follow these guidelines:

- Use separate paths to route wiring for power and devices. If power wiring and device wiring paths must cross, make sure the wires are perpendicular at the intersection point.
NOTE: Do not run signal or communications wiring and power wiring through the same wire conduit. To avoid interference, wires with different signal characteristics should be routed separately
- You can use the type of signal transmitted through a wire to determine which wires should be kept separate. The rule of thumb is that wiring that shares similar electrical characteristics can be bundled together
- You should separate input wiring from output wiring
- We advise that you label the wiring to all devices in the system.

Grounding the Moxa EDS-518E

Grounding and wire routing help limit the effects of noise due to electromagnetic interference (EMI). Run the ground connection from the ground screw to the grounding surface prior to connecting devices.



ATTENTION

This product is intended to be mounted to a well-grounded mounting surface such as a metal panel.

Wiring the Relay Contact

The EDS-518E series has one relay output. This relay contact uses two contacts of the terminal block on the EDS-518E's top panel. Refer to the next section for detailed instructions on how to connect the wires to the terminal block connector, and how to attach the terminal block connector to the terminal block receptor. In this section, we illustrate the meaning of the two contacts used to connect the relay contact.

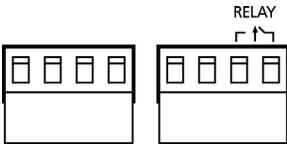

FAULT:

The two contacts of the 4-pin terminal block connector are used to detect user-configured events. The two wires attached to the fault contacts form an open circuit when a user-configured event is triggered. If a user-configured event does not occur, the fault circuit remains closed.

Wiring the Redundant Power Inputs

The EDS-518E has two sets of power inputs—power input 1 and power input 2. The top view of the terminal block connectors is shown here.

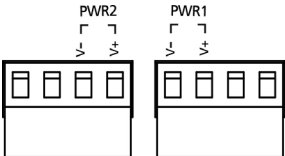

STEP 1: Insert the negative/positive DC wires into the V-/V+ terminals, respectively.

STEP 2: To keep the DC wires from pulling loose, use a small flat-blade screwdriver to tighten the wire-clamp screws on the front of the terminal block connector.

STEP 3: Insert the plastic terminal block connector prongs into the terminal block receptor, which is located on the EDS-518E's top panel.

Wiring the Digital Inputs

The EDS-518E has one digital input (DI). The DI consists of two contacts of the 4-pin terminal block connector on the EDS-518E's top panel, which are used for the two DC inputs. The top view of the terminal block connectors is shown here.

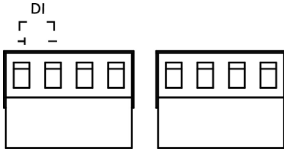

STEP 1: Insert the negative (ground)/positive DI wires into the \pm /I terminals, respectively.

STEP 2: To keep the DI wires from pulling loose, use a small flat-blade screwdriver to tighten the wire-clamp screws on the front of the terminal block connector.

STEP 3: Insert the plastic terminal block connector prongs into the terminal block receptor, which is located on the EDS-518E's top panel.

Communication Connections

Each EDS-518E switch has 4 types of communication ports:

- 1 USB console port (type B connector)
- 1 USB storage port (type A connector)
- 14 10/100BaseTX Ethernet ports (EDS-518E-4GTXSFP series) or 12 10/100BaseT(X) Ethernet ports plus 2 100BaseFX (SC/ST-type connector) fiber ports (EDS-518E-MM-SC-4GTXSFP/EDS-518E-SS-SC-4GTXSFP/EDS-518E-MM-ST-4GTXSFP)
- 4 Gigabit Ethernet combo ports:
4 10/100/1000BaseT(X) and 4 100/1000BaseSFP ports

USB Console Connection

The EDS-518E has one USB console port (type B connector) located on the top panel. Use the USB cable (provided in the product package) to connect the EDS-518E's console port to your PC's USB port and install the USB driver (available on the software CD) on the PC. You may then use a console terminal program, such as Moxa PComm Terminal Emulator, to access the EDS-518E's console configuration utility.

USB Console Port (Type B Connector) Pinouts

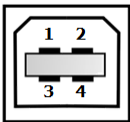

Pin	Description
1	D- (Data-)
2	VCC (+5V)
3	D+ (Data+)
4	GND (Ground)

USB Storage Connection

The EDS-518E has one USB storage port (type A connector) on the front panel. Use the Moxa ABC-02-USB-T automatic backup configurator to connect the EDS-518E's USB storage port for configuration backup, firmware upgrade, or system log file backup.

ABC-02-USB Installation

Plug the ABC-02-USB into the USB storage port of the Moxa EDS-518E. The ABC-02-USB can be secured to the wall with an M4 screw.

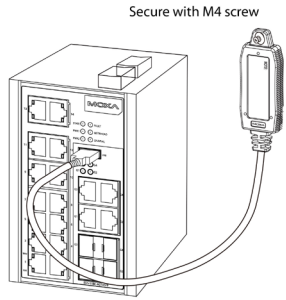

USB Storage Port (Type A Connector) Pinouts

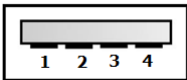

Pin	Description
1	VCC (+5V)
2	D- (Data-)
3	D+ (Data+)
4	GND (Ground)

10/100BaseT(X) Ethernet Port Connection

The 10/100BaseT(X) ports located on the EDS-518E's front panel are used to connect to Ethernet-enabled devices. Most users will choose to configure these ports for Auto MDI/MDI-X mode, in which case the port's pinouts are adjusted automatically depending on the type of Ethernet cable used (straight-through or cross-over), and the type of device (NIC-type or HUB/Switch-type) connected to the port.

In what follows, we give pinouts for both MDI (NIC-type) ports and MDI-X (HUB/Switch-type) ports. We also give cable wiring diagrams for straight-through and cross-over Ethernet cables.

10/100Base T(x) RJ45 Pinouts

MDI Port Pinouts

Pin	Signal
1	Tx+
2	Tx-
3	Rx+
6	Rx-

MDI-X Port Pinouts

Pin	Signal
1	Rx+
2	Rx-
3	Tx+
6	Tx-

8-pin RJ45

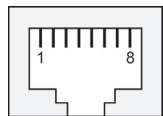

RJ45 (8-pin) to RJ45 (8-pin) Straight-Through Cable Wiring

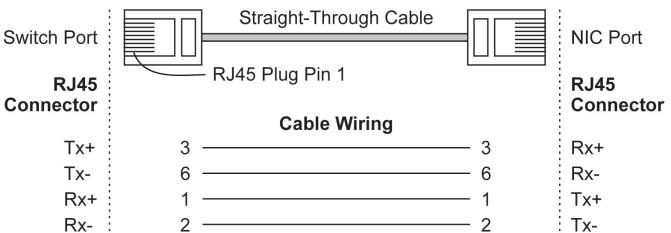

RJ45 (8-pin) to RJ45 (8-pin) Cross-Over Cable Wiring

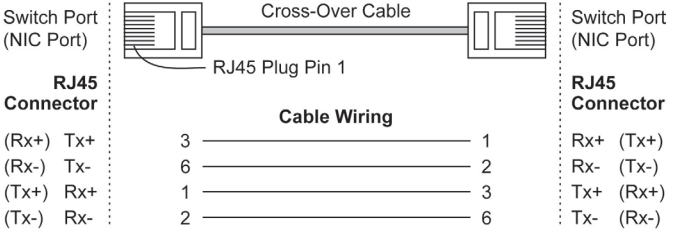

100BaseFx Ethernet Port Connection

The concept behind the SC/ST port and cable is quite straightforward. Suppose you are connecting devices I and II. As opposed to electrical signals, optical signals do not require a circuit in order to transmit data. Consequently, one of the optical lines is used to transmit data from device I to device II, and the other optical line is used transmit data from device II to device I, for full-duplex transmission.

All you need to remember is to connect the Tx (transmit) port of device I to the Rx (receive) port of device II, and the Rx (receive) port of device I to the Tx (transmit) port of device II. If you are making your own cable, we suggest labeling the two sides of the same line with the same letter (A-to-A and B-to-B, as shown by the following illustration, or A1-to-A2 and B1-to-B2).

SC-Port Pinouts

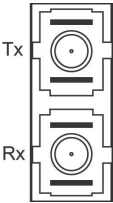

SC-Port to SC-Port Cable Wiring

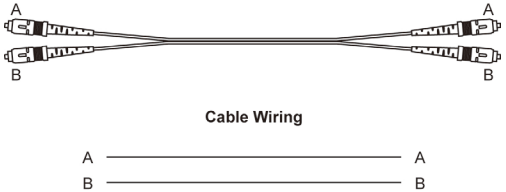

ST-Port Pinouts

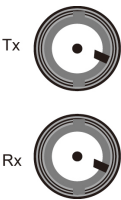

ST-Port to ST-Port Cable Wiring

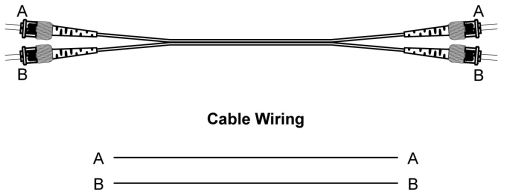

ATTENTION

This is a Class 1 Laser/LED product. To prevent damage to your eyes, do not stare directly into the laser beam.

1000BaseT Ethernet Port Connection

1000BaseT data is transmitted on differential TRD+/- signal pairs over copper wires.

MDI/MDI-X Port Pinouts

Pin	Signal
1	TRD(0)+
2	TRD(0)-
3	TRD(1)+
4	TRD(2)+
5	TRD(2)-
6	TRD(1)-
7	TRD(3)+
8	TRD(3)-

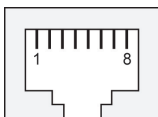

100/1000BaseSFP (mini-GBIC) Fiber Port

The Gigabit Ethernet fiber ports on the EDS-518E are 100/1000BaseSFP fiber ports, which require using 100M or 1G mini-GBIC fiber transceivers to work properly. Moxa provides a complete selection of transceiver models for different distance requirements.

The concept behind the LC port and cable is straightforward. Suppose you are connecting devices I and II; contrary to electrical signals, optical signals do not require a circuit in order to transmit data. Consequently, one of the optical lines is used to transmit data from device I to device II, and the other optical line is used to transmit data from device II to device I, for full-duplex transmission.

Remember to connect the Tx (transmit) port of device I to the Rx (receive) port of device II, and the Rx (receive) port of device I to the Tx (transmit) port of device II. If you make your own cable, we suggest labeling the two sides of the same line with the same letter (A-to-A and B-to-B, as shown below, or A1-to-A2 and B1-to-B2).

LC-Port Pinouts

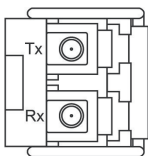

LC-Port to LC-Port Cable Wiring

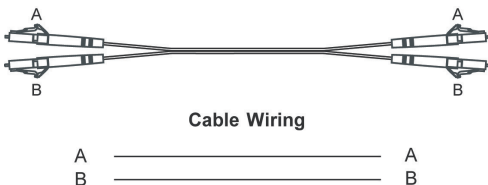

ATTENTION

This is a Class 1 Laser/LED product. To avoid causing serious damage to your eyes, do not stare directly into the Laser Beam.

Reset Button

The Reset Button supports two functions. One is to reset the Ethernet switch to factory default settings by pressing and holding the Reset button for 5 seconds. Use a pointed object, such as a straightened paper clip or toothpick, to depress the Reset button. This will cause the STATE LED to blink once a second. After depressing the button for 5 continuous seconds, the STATE LED will start to blink rapidly, indicating that factory default settings have been loaded and you can release the reset button.

When the ABC-02-USB is connected to the EDS-518E Ethernet switch, the reset button allows quick configuration and backs up log files to the ABC-02-USB. Press the Reset button on top of the EDS-518E; the Ethernet switch will start backing up the current system configuration files and event logs to the ABC-02-USB.

NOTE Do NOT power off the Ethernet switch when loading default settings.

Turbo Ring DIP Switch Settings

The EDS-518E switches are plug-and-play managed redundant Ethernet switches. The proprietary Turbo Ring protocol was developed by Moxa to provide better network reliability and faster recovery time. Moxa Turbo Ring's recovery time is less than 300 ms (**Turbo Ring**) or 20 ms (**Turbo Ring V2**)—compared to a 3- to 5-minute recovery time for commercial switches—decreasing the possible loss caused by network failures in an industrial setting.

The 4 Hardware DIP Switches located on the top panel of the EDS-518E can be used to easily configure Turbo Ring in only a few seconds. If you do not want to use a hardware DIP switch to configure Turbo Ring, you can use a web browser, Telnet, or serial console to disable the DIP switches.

NOTE Refer to the **Turbo Ring** section in the **Communication Redundancy** User's Manual for detailed information about the settings and usage of **Turbo Ring** and **Turbo Ring V2**.

EDS-518E Series DIP Switches

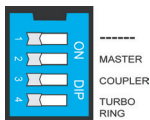

The default setting for each DIP Switch is OFF. The following table explains the effect of setting the DIP Switch to the ON position.

"Turbo Ring" DIP Switch Settings

DIP 1	DIP 2	DIP 3	DIP 4
Reserved for future use.	<u>ON</u> : Enables this EDS as the Ring Master.	<u>ON</u> : Enables the default "Ring Coupling" and "Ring Coupling Control" ports.	<u>ON</u> : Activates DIP switch 2 and 3 to configure "Turbo Ring" settings.
	<u>OFF</u> : This EDS will not be the Ring Master.	<u>OFF</u> : Do not use this EDS as the ring coupler.	<u>OFF</u> : DIP switch 1, 2, and 3 will be disabled.

“Turbo Ring V2” DIP Switch Settings

DIP 1	DIP 2	DIP 3	DIP 4
ON: Enables the default “Ring Coupling (backup)” port when DIP switch 3 is already enabled.	ON: Enables this EDS as the Ring Master.	ON: Enables the default “Ring Coupling” port.	ON: Activates DIP switch 1, 2, and 3 to configure “Turbo Ring V2” settings.
OFF: Enables the default “Ring Coupling (primary)” port when DIP switch 3 is already enabled.	OFF: This EDS will not be the Ring Master.	OFF: Do not use this EDS as a ring coupler.	OFF: DIP switches 1, 2, and 3 will be disabled.

NOTE You must enable the Turbo Ring function first before using the DIP switch to activate the Master and Coupler functions.

NOTE If you do not enable any of the EDS-518E series switches to be the Ring Master, the Turbo Ring protocol will automatically choose the EDS-518E series with the smallest MAC address range to be the Ring Master. If you accidentally enable more than one EDS-518E series to be the Ring Master, these EDS-518E series switches will auto-negotiate to determine which one will be the Ring Master.

LED Indicators

The front panel of the Moxa EDS-518E has several LED indicators. The function of each LED is described in the following table:

LED	Color	Status	Description
STATE	Green	On	The system passed the self-diagnosis test on boot-up and is ready to run.
		Blinking	<ul style="list-style-type: none"> Once every second: The switch is being reset. Once every two seconds: ABC-02-USB is connected to the switch.
	Red	On	The system failed self-diagnosis on boot-up. <ul style="list-style-type: none"> RAM Test Fail / System Info. Read Fail / Switch Initial Fail / PTP PHY Error. (+ Green MSTR lit on : HW FAIL) FW Checksum Fail / Uncompress Fail. (+ Green Coupler lit on: SW FAIL)
FAULT	Red	On	<ol style="list-style-type: none"> The signal contact is open. ABC Loading/Saving Fail. The port is being disabled because the ingress multicast and broadcast packets exceed the ingress rate limit. Incorrect loop connection in a single switch. Invalid Ring port connection.

LED	Color	Status	Description
PWR1	Amber	On	Power is being supplied to the main module's power input PWR1.
		Off	Power is not being supplied to the main module's power input PWR1.
PWR2	Amber	On	Power is being supplied to the main module's power input PWR2.
		Off	Power is not being supplied to the main module's power input PWR2.
MSTR/ HEAD	Green	On	<ol style="list-style-type: none"> The switch is set as the Master of the Turbo Ring, or as the Head of the Turbo Chain. POST H.W. Fail (+Stat on and Fault blinking).
		Blinking	<ol style="list-style-type: none"> The switch has become the Ring Master of the Turbo Ring. The switch has become the Head of the Turbo Chain, after the Turbo Ring or Turbo Chain has gone down. The switch is set as the Turbo Chain's Member and the corresponding chain port is down.
		Off	<ol style="list-style-type: none"> The switch is not the Master of this Turbo Ring. This switch is set as a Member of the Turbo Chain.
CPLR/ TAIL	Green	On	<ol style="list-style-type: none"> The switch's coupling function is enabled to form a back-up path. The switch is set as the Tail of the Turbo Chain. POST S.W. Fail (+Stat on and Fault blinking)
		Blinking	<ol style="list-style-type: none"> Turbo Chain is down. The switch is set as Turbo Chain's Member and the corresponding chain port is down.
		Off	<ol style="list-style-type: none"> This switch has disabled the coupling function. This switch is set as a Member of the Turbo Chain.
FAULT + MSTR/HEAD + CPLR/TAIL		Rotate Blinking Sequentially	ABC-02-USB is importing/exporting files.
STATE + FAULT + MSTR/HEAD + CPLR/TAIL		Blinking	Switch is being discovered/located by MXview (twice per second).
10M (TP)	Green	On	TP port's 10 Mbps link is active.
		Blinking	Data is being transmitted at 10 Mbps.
		Off	TP port's 10 Mbps link is inactive.
100M (TP/ Fixed FX)	Green	On	TP/Fixed FX port's 100 Mbps link is active.
		Blinking	Data is being transmitted at 100 Mbps.
		Off	TP/Fixed FX port's 100 Mbps link is inactive.

LED	Color	Status	Description
100M (TP/SFP combo ports)	Amber	On	TP/SFP combo port's 100 Mbps link is active.
		Blinking	Data is being transmitted at 100 Mbps.
		Off	TP/SFP combo port's 100 Mbps link is inactive.
1000M (TP/SFP combo port)	Green	On	TP/SFP combo port's 1000 Mbps link is active.
		Blinking	Data is being transmitted at 1000 Mbps.
		Off	TP/SFP combo port's 1000 Mbps link is inactive.

Specifications

Technology	
Standards	IEEE 802.3 for 10BaseT IEEE 802.3u for 100BaseT(X) and 100BaseFX IEEE 802.3ab for 1000BaseT(X) IEEE 802.3z for 1000BaseX IEEE 802.3x for Flow Control IEEE 802.1D-2004 for Spanning Tree Protocol IEEE 802.1w for Rapid STP IEEE 802.1s for Multiple Spanning Tree Protocol IEEE 802.1Q for VLAN Tagging IEEE 802.1p for Class of Service IEEE 802.1x for Authentication IEEE 802.3ad for Port Trunk with LACP
Protocols	IGMPv1/v2/v3, GMRP, GVRP, SNMPv1/v2c/v3, DHCP Server/Client, DHCP Option 66/67/82, BootP, TFTP, SNTP, SMTP, RARP, RMON, HTTP, HTTPS, Telnet, SSH, Syslog, EtherNet/IP, PROFINET, Modbus/TCP, SNMP Inform, LLDP, IEEE 1588 v2 PTP, IPv6, NTP Server/Client
MIB	MIB-II, Ethernet-Like MIB, P-BRIDGE MIB, Q-BRIDGE MIB, Bridge MIB, RSTP MIB, RMON MIB Group 1, 2, 3, 9
Flow Control	IEEE 802.3x flow control, back pressure flow control
Interface	
RJ45 Ports	EDS-518E-MM-ST/SC-4GTXSFP and EDS-518E-SS-SC-4GTXSFP: 10/100BaseT(X) ports: 12 10/100/1000BaseT(X) ports: 4 EDS-518E-4GTXSFP: 10/100BaseT(X) ports: 14 10/100/1000BaseT(X) ports: 4
Fiber Ports	EDS-518E-MM-ST/SC-4GTXSFP and EDS-518E-SS-SC-4GTXSFP: 100BaseFX ports (SC/ST connector): 2 100/1000BaseSFP slots: 4
USB Ports	USB console port (type B connector) USB storage port (type A connector)
Button	Reset button
LED Indicators	PWR1, PWR2, FAULT, STATE, 10/100M, 100/1000M, MSTR/HEAD, CPLR/TAIL

Alarm Contact	1 relay output with current carrying capacity of 1 A @ 24 VDC
Digital Input	1 input with the same ground, but electrically isolated from the electronics. +13 to +30 V for state "1" -30 to +3 V for state "0" Max. input current: 8 mA
Power	
Input Voltage	12/24/48/-48 VDC, redundant dual inputs
Input Current	EDS-518E-4GTXSFP: 0.75 A @ 24 V EDS-518E-MM-ST/SC-4GTXSFP: 0.61 A @ 24 V EDS-518E-SS-SC-4GTXSFP: 0.61 A @ 24 V
Connection	2 removable 4-contact terminal blocks
Overload Current Protection	Present
Reverse Polarity Protection	Present
Physical Characteristics	
Housing	Metal, IP30 protection
Dimensions	94 x 135 x 138 mm (3.7 x 5.31 x 5.44 in)
Installation	DIN-rail mounting, wall mounting (with optional kit)
Environmental Limits	
Operating Temperature	-10 to 60°C (14 to 140°F) for standard models -40 to 75°C (-40 to 167°F) for -T models
Storage Temperature	-40 to 85°C (-40 to 185°F)
Ambient Relative Humidity	5 to 95% (non-condensing)
Altitude	Up to 2000 m Note: Please contact Moxa if you require products guaranteed to function properly at higher altitudes.
Regulatory Approvals	
Safety	UL 508
EMI	FCC Part 15 Subpart B Class A, EN 55022 Class A
EMS	EN 61000-4-2 (ESD) Level 4, EN 61000-4-3 (RS) Level 3, EN 61000-4-4 (EFT) Level 4, EN 61000-4-5 (Surge) Level 4, EN 61000-4-6 (CS) Level 3, EN 61000-4-8
Shock	IEC 60068-2-27
Free Fall	IEC 60068-2-32
Vibration	IEC 60068-2-6
Warranty	
Warranty	5 years

Technical Support Contact Information
www.moxa.com/support

Moxa Americas:

Toll-free: 1-888-669-2872

Tel: 1-714-528-6777

Fax: 1-714-528-6778

Moxa Europe:

Tel: +49-89-3 70 03 99-0

Fax: +49-89-3 70 03 99-99

Moxa China (Shanghai office):

Toll-free: 800-820-5036

Tel: +86-21-5258-9955

Fax: +86-21-5258-5505

Moxa Asia-Pacific:

Tel: +886-2-8919-1230

Fax: +886-2-8919-1231