

# **TN-5510A-2GLSX-ODC and TN-5510A-8POE-2GLSX-ODC Hardware Installation Guide**

---

**Moxa ToughNet Switch**

**Second Edition, March 2015**

**MOXA®**

© 2015 Moxa Inc. All rights reserved.  
Reproduction without permission is prohibited.

**P/N: 1802055100061**



## Overview

The ToughNet TN-5510A-2GLSX-ODC and TN-5510A-8POE-2GLSX-ODC series M12 managed Ethernet switches are designed for industrial applications in harsh environments. The TN series switches use M12 connectors to ensure tight, robust connections, and guarantee reliable operation against environmental disturbances, such as vibration and shock. The wide 24 to 110 VDC range with dual power inputs (non-PoE series) increases the reliability of your communications.

The TN-5510A-2GLSX-ODC and TN-5510A-8PoE-2GLSX-ODC switches provide up to 8 Fast Ethernet M12 ports, and 2 ports on the down side to provide the Gigabit fiber interface with an embedded 2 km multimode fiber transceiver. Moreover, the -40 to 75°C operating temperature and IP54-rated waterproof enclosure allow deployment in harsh environments. The TN-5510A Ethernet switch is compliant with the essential sections of EN 50155 (railway applications), making it suitable for a variety of industrial applications.

## Package Checklist

The ToughNet TN-5510A-2GLSX-ODC and TN-5510A-8POE-2GLSX-ODC switches are shipped with the following items. If any of these items are missing or damaged, please contact your customer service representative for assistance.

- 1 Moxa ToughNet switch
- M12 to DB9 console port cable
- 2 protective caps for console and relay output ports
- Panel mounting screws
- CD-ROM with user's manual
- Hardware installation guide
- Warranty card

## Features

### ***Anti-Vibration Circular Connectors for Robust Links***

- M12 D-coding 4-pin female connectors for Fast Ethernet 10/100BaseT(X) ports
- Fiber-optic ODC connectors with embedded 2 km Gigabit Ethernet 1000BaseLSX
- M12 A-coding 5-pin male connectors for console and relay output
- M23 6-pin male connector for power input

### ***Dual Power Inputs***

- Supports 24-110 VDC (16.8 to 137.5 VDC)

### ***High Performance Network Switching Technology***

- IEEE 1588 PTP (Precision Time Protocol) for precise time synchronization of networks
- DHCP Option 82 for IP address assignment with different policies
- EtherNet/IP and Modbus/TCP industrial Ethernet protocols supported
- Turbo Ring and Turbo Chain (recovery time <20 ms @250 switches), and STP/RSTP/MSTP for network redundancy
- IGMP Snooping and GMRP for filtering multicast traffic from industrial Ethernet protocols
- Port-based VLAN, IEEE802.1Q VLAN, and GVRP protocol to ease network planning

- QoS (IEEE 802.1p/1Q and ToS/DiffServ) allows real-time traffic classification and prioritization
- 802.3ad, LACP for optimum bandwidth utilization
- TACACS+, SNMPv3, IEEE 802.1X, HTTPS, and SSH to enhance network security
- SNMP v1/v2c/v3 for different levels of network management
- RMON for efficient network monitoring and proactive capability
- Bandwidth management prevents unpredictable network status
- Lock port allows access by only authorized MAC addresses
- Port mirroring for online debugging
- Automatic warning by exception through email, relay output
- Automatic recovery of connected device's IP addresses
- Line-swap fast recovery
- LLDP for automatic topology discovery in network management software
- Loop protection prevents network loops
- Configurable through Web browser, Telnet/serial console, CLI, and Windows utility

### ***Designed for Industrial-Specific Applications***

- Two Gigabit fiber ports to meet high EMI immunity, long-distance, and bandwidth requirements
- Essential compliance with EN 50155
- -40 to 75°C operating temperature range
- IP54, rugged high-strength case
- Panel mounting or DIN rail mounting installation capability

### **Recommended Optional Accessories**

- CBL-M23(FF6P)Open-BK-100-IP67: 1-meter M23 to 6-pin power cable with IP67-rated female 6-pin M23 connector
- CBL-M12D(MM4P)/RJ45-100 IP67: 1-meter M12-to-RJ45 Cat-5E UTP Ethernet cable with IP67-rated male 4-pin M12 D-coded connector
- CBL-M12(FF5P)/OPEN-100 IP67: 1-meter M12-to-5-pin power cable with IP67-rated female 5-pin M12 A-coded connector
- M12D-4P-IP68: Field-installable M12 D-coded screw-in connector, male 4-pin, IP68-rated
- M12A-5P-IP68: Field-installable M12 A-coded screw-in connector, female 5-pin, IP68-rated
- CAP-M12F-M: Metal cap for M12 female connector
- DK-DC50131: DIN rail mounting kit, 50 x 131 mm

# TN-5510A-2GLSX-ODC Panel Layouts

Top View

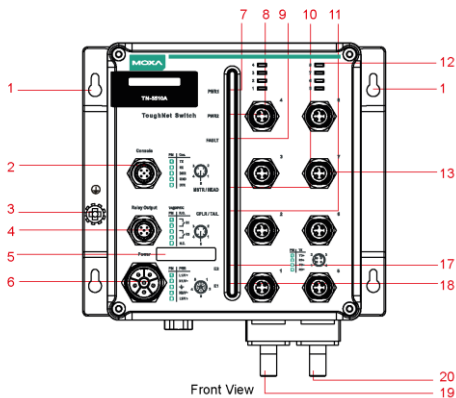
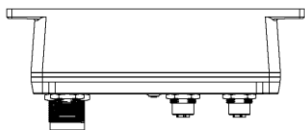

Front View

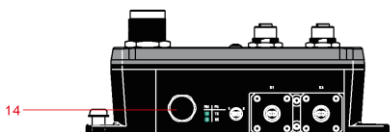

Bottom View

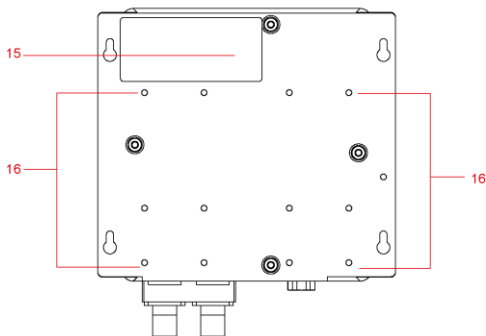

Rear View

1. Screw holes for panel mounting kit
2. Console port
3. Grounding screw
4. Relay output port
5. Power input voltage range indicator
6. Power input port (male 6-pin shielded M23 connector)
7. PWR1 LED: for power input 1

8. PWR2 LED: for power input 2
9. FAULT LED
10. MSTR/HEAD LED: for ring master or chain head
11. CPLR/TAIL LED: for ring coupler or chain tail
12. TP port's 10/100 Mbps LED
13. 10/100BaseT(X) port (female 4-pin shielded M12 connector with D coding)
14. Waterproof vent
15. Product label
16. 12 screw holes for DIN rail mounting kit
17. E2 LED: Down-side E2 Gigabit port's 1000 Mbps LED
18. E1 LED: Down-side E1 Gigabit port's 1000 Mbps LED
19. Gigabit fiber port E1 (corresponding to port 9 in the TN-5510A User's Manual)
20. Gigabit fiber port E2 (corresponding to port 10 in the TN-5510A User's Manual)



### **ATTENTION**

Please DO NOT open or remove vent **15**. The warranty will be invalid if the seal is removed.

All exposed connectors, including **3, 5, 7, and 14**, should be tightly covered by protective caps when they are not in use to ensure IP54 protection.

# Mounting Dimensions (unit = mm)

## TN-5510A-2GLSX-ODC Series

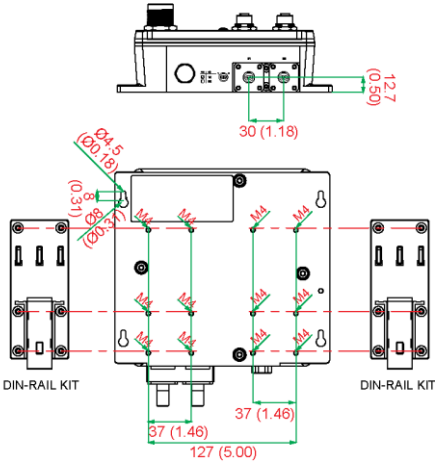
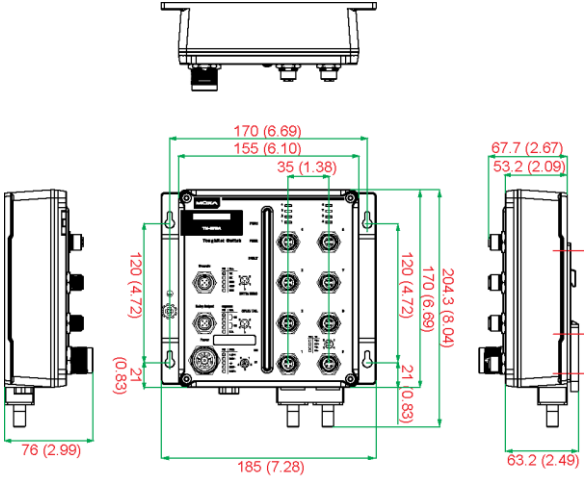



# Panel/Wall Mounting

## STEP 1:

Mounting the TN-5510A to a wall requires 4 screws. Use the ToughNet switch as a guide to mark the correct positions of the 4 screws.

## STEP 2:

Use the 4 screws in the panel mounting kit. If you would like to use your own screws, make sure the screw head is **between 6.0 mm and 7.0 mm** in diameter and the shaft is less than **4.0 mm** in diameter, as shown at the right.

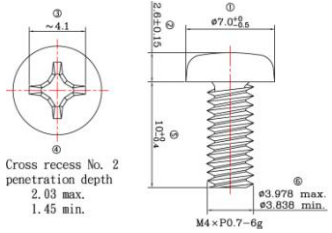

Do not screw the screws in all the way—leave a space of about 2 mm to allow room for sliding the ToughNet switch between the wall and the screws.

**NOTE** Before tightening the screws into the wall, make sure the screw head and shaft size are suitable by inserting the screw through one of the keyhole-shaped apertures of the ToughNet switch.

## STEP 3:

Once the screws are fixed in the wall, hang the ToughNet switch on the 4 screws through the large opening of the keyhole-shaped apertures, and then slide the switch downwards. Tighten the four screws for added stability.

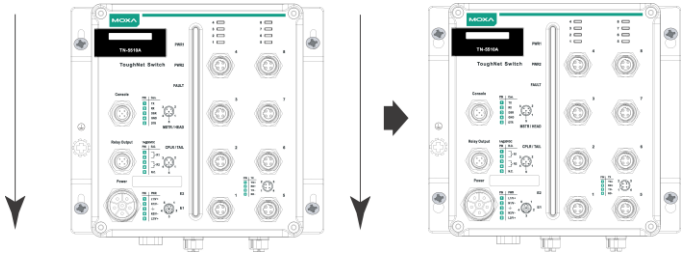

**NOTE** To provide greater protection from vibration and shock, use screws with shaft diameter between 6.0 mm and 7.0 mm, and fix the ToughNet switch onto the wall directly through the large opening of the keyhole-shaped apertures.



## DIN Rail Mounting (optional)

Use a pair of optional DK-DC50131 DIN rail mounting kits (must be purchased separately) to mount the TN-5510A on a 35 mm DIN rail.

### STEP 1:

Use 12 screws (6 screws per plate) to attach the two DIN rail attachment plates to the rear panel of the switch.

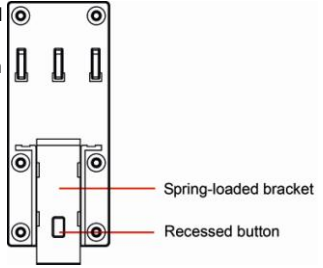

### STEP 2:

If the spring-loaded bracket is locked in place, push the recessed button to release it. Once released, you should feel some resistance from the spring as you slide the bracket up and down a few millimeters in each direction.

### STEP 3:

Insert the top of the DIN rail into the top slot of the DIN rail attachment plates.

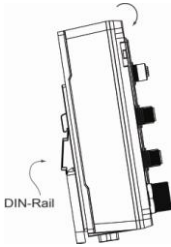

### STEP 4:

The DIN rail attachment plates will snap into position, as shown in the figure below.

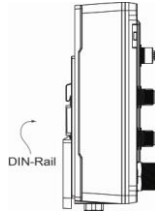

To remove the Moxa ToughNet Switch from the DIN rail, use a screwdriver to pull down the bottom parts of the two spring-loaded brackets until they are fixed in the "locked" position, and then reverse Steps 3 and 4 above.

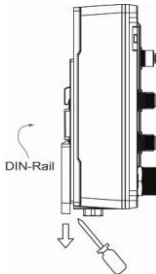

## Wiring Requirements



### WARNING

Turn the power off before disconnecting modules or wires. The correct power supply voltage is listed on the product label. Check the voltage of your power source to make sure you are using the correct voltage. Do NOT use a voltage greater than what is specified on the product label.

These devices must be supplied by a SELV source as defined in the Low Voltage Directive 2006/95/EC and 2004/108/EC.



### ATTENTION

#### Safety First!

Observe all electrical codes dictating the maximum current allowable for each wire size. If the current goes above the maximum ratings, the wiring could overheat, causing serious damage to your equipment.



### ATTENTION

#### Safety First!

Be sure to disconnect the power cord before installing and/or wiring your Moxa switch.

This device has UL 508 approval. Use copper conductors only, 60/75°C, and tighten to 4.5 pound-inches. For use in pollution degree 2 environments.

Please read and follow these guidelines:

- Use separate paths to route wiring for power and devices. If power wiring and device wiring paths must cross, make sure the wires are perpendicular at the intersection point.

**NOTE** Do not run signal or communications wiring and power wiring through the same wire conduit. To avoid interference, wires with different signal characteristics should be routed separately.

- You can use the type of signal transmitted through a wire to determine which wires should be kept separate. The rule of thumb is that wiring that shares similar electrical characteristics can be bundled together.
- Keep input wiring and output wiring separated.
- It is strongly advised that you label wiring for all devices in the system when necessary.

## Grounding the ToughNet Switch

Grounding and wire routing help limit the effects of noise due to electromagnetic interference (EMI). Run the ground connection from the grounding screw to the grounding surface prior to connecting devices.

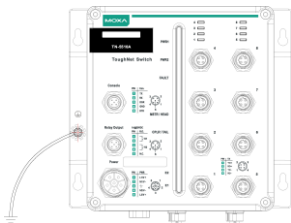

### ATTENTION

This product is intended to be mounted to a well-grounded mounting surface such as a metal panel.

## Connecting the Power Supplies

In non-PoE switches, the ToughNet TN-5510A series switches support two sets of power input—power input 1 and power input 2. The M23 6-pin male connector on the TN-5510A non-PoE switches' front panel is used for the dual power inputs.

### Pinouts for the power input port on the TN-5510A (non-PoE series)

PIN	PWR
1	L1/V+
2	N1/V-
3	$\perp$
4	N2/V-
5	L2/V+



### Pinouts for the power input port on the TN-5510A-PoE series

PIN	PWR
1	L1/V+
2	N1/V-
3	$\perp$
4	
5	

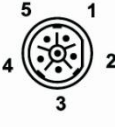

## **Pinouts for the power input port on the TN-5510A**

<b>Pin</b>	<b>Description</b>	<b>Usage</b>
1	PWR1 Live / DC +	Connect "PWR1 Live / DC +" to the positive (+) terminal when using a DC power source.
2	PWR1 Neutral / DC -	Connect "PWR1 Neutral / DC -" to the negative (-) terminal when using a DC power source. The negative inputs for the two power supplies are N1/V- and N2/V-.
3	Chassis Ground	Connect the "Chassis Ground" to the equipment ground bus for DC inputs.
4	PWR2 Neutral / DC -	Connect "PWR2 Neutral / DC -" to the negative (-) terminal when using a DC power source. The negative inputs for the two power supplies are N1/V- and N2/V-.
5	PWR2 Live / DC +	Connect "PWR2 Live / DC +" to the positive (+) terminal when using a DC power source.

### **STEP 1:**

Plug your power cord's M23 connector into the power input port of the TN-5510A switch.

### **STEP 2:**

Screw the nut on your power cord connector to the power input connector on the switch to ensure a tight connection.



## **ATTENTION**

Before connecting the TN-5510A to the power input, make sure the power source voltage is stable.

## **Connecting the Relay Outputs**

Each TN-5510A switch has two sets of relay outputs—relay output 1 and relay output 2. The M12 A-coded 5-pin male connector on the TN-5510A's front panel is used for the two relay outputs. Use a power cord with an M12 A-coded 5-pin female connector to connect the relay contacts from the switch. You may purchase an M12 power cable from Moxa. The model number of the cable, which must be purchased separately, is CBL-M12 (FF5P)/OPEN-100 IP67.

## **Pinouts for the relay output port on TN-5510A**

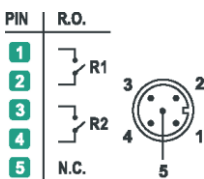

**N.C.:** Not connected

### **FAULT:**

The two sets of relay contacts of the M12 A-coded 5-pin male connector are used to detect user-configured events. The two wires attached to the fault contacts form an open circuit when a user-configured event is triggered. If a user-configured event does not occur, the fault circuit remains closed.

## RS-232 Connection

The TN switch has one RS-232 (M12 5-pin) console port, located on the front panel. Use an M12-to-DB9 console cable to connect the TN switch's console port to your PC's COM port. You may then use a console terminal program, such as Moxa PComm Terminal Emulator to access the TN switch's configuration utility.

### M12 Console Port Pinouts

PIN	Con.
1	TX
2	RX
3	DSR
4	GND
5	DTR



## Connecting the Data Lines

### 10/100BaseT(X) Ethernet Port Connection

All TN-5510A models have 8 10/100BaseT(X) Ethernet ports (4-pin shielded M12 connector with D coding). The 10/100BaseTX ports located on the TN-5510A's front panel are used to connect to Ethernet-enabled devices. Most users configure these ports for Auto MDI/MDI-X mode, in which case the port's pinouts are adjusted automatically depending on the type of Ethernet cable used (straight-through or cross-over), and the type of device (NIC-type or HUB/Switch-type) connected to the port.

In what follows, we give pinouts for both MDI (NIC-type) ports and MDI-X (HUB/Switch-type) ports. We also give cable wiring diagrams for straight-through and cross-over Ethernet cables.

### Pinouts for the 10/100BaseT(X) Ports on the TN-5510A

PIN	TX
1	TD+
2	RD+
3	TD-
4	RD-



### Pinouts for the 1000BaseLSX Q-ODC® Gigabit Fiber port

PIN	FO
1	TX
2	RX



### Mating Sequence

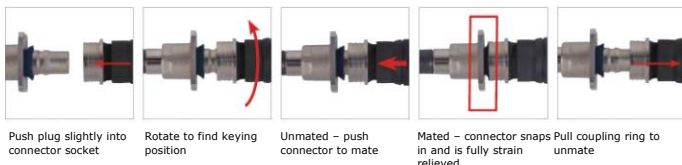

### **M12 (4-pin, M) to M12 (4-pin, M) Cross-Over Cable Wiring**

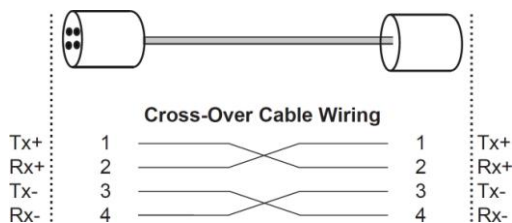

### **M12 (4-pin, M) to M12 (4-pin, M) Straight-Trough Cable Wiring**

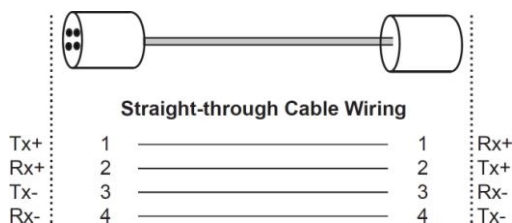

### **M12 (4-pin, M) to RJ45 (8-pin) Cross-Over Cable Wiring**

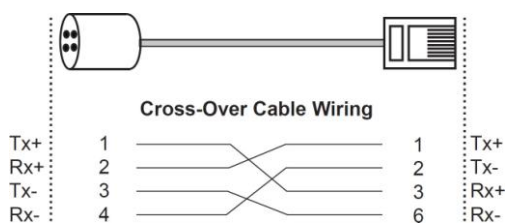

### **M12 (4-pin, M) to RJ45 (8-pin) Straight-Trough Cable Wiring**

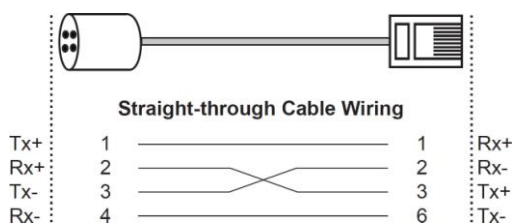

### **ATTENTION**

The protective cover must be fixed properly to ensure IP54 protection. Use a torque wrench set to a torque of 4 kgf-m when tightening the screws. Note that applying a larger torque may damage the plastic protective cover.

## LED Indicators

Several LED indicators are located on the ToughNet switch's front panel. The function of each LED is described in the following table.

LED	Color	State	Description
<b>System LEDs</b>			
PWR1	AMBER	ON	Power is being supplied to power input PWR1.
		OFF	Power is not being supplied to power input PWR1
PWR2	AMBER	ON	Power is being supplied to power input PWR2.
		OFF	Power is not being supplied to power input PWR2.
FAULT	RED	ON	When the corresponding PORT alarm is enabled, and a user-configured event is triggered.
		OFF	When the corresponding PORT alarm is enabled and a user-configured event is not triggered, or when the corresponding PORT alarm is disabled.
MSTR/ HEAD	GREEN	ON	When the TN switch is either the Master of this Turbo Ring, or the Head of this Turbo Chain.
		Blinking	When the TN switch is Ring Master of this Turbo Ring and the Turbo Ring is broken, or it is Chain Head of this Turbo Chain and the Turbo Chain is broken.
		OFF	When the TN switch is neither the Master of this Turbo Ring, nor the Head of this Turbo Chain.
CPLR/ TAIL	GREEN	ON	When the TN switch enables the coupling function to form a back-up path in this Turbo Ring, or it is the Tail of this Turbo Chain.
		Blinking	When the Turbo Chain is down.
		OFF	When the TN switch disables the coupling function of Turbo Ring, or it is not the Tail of the Turbo Chain.
<b>Ports LEDs</b>			
TP (10/ 100M)	AMBER	ON	TP port's 10 Mbps link is active.
		Blinking	Data is being transmitted at 10 Mbps.
		OFF	TP port's 10 Mbps link is inactive.
	GREEN	ON	TP port's 100 Mbps link is active.
		OFF	TP port's 100 Mbps link is inactive.
PoE Ports	AMBER	ON	Power is being supplied to a Powered Device (PD)
		OFF	Power is not being supplied to a Powered Device (PD)
E1/E2 (1000M)	GREEN	ON	TP port's 1000 Mbps link is active.
		Blinking	Data is being transmitted at 1000 Mbps.
		OFF	TP port's 1000 Mbps link is inactive.

## Specifications

<b>Technology</b>	
Standards	IEEE 802.3 for 10BaseT IEEE 802.3u for 100BaseT(X) IEEE 802.3ab for 1000BaseT(X) IEEE 802.3x for Flow Control IEEE 802.1D for Spanning Tree Protocol IEEE 802.1w for Rapid STP IEEE 802.1s for Multiple Spanning Tree Protocol IEEE 802.1Q for VLAN Tagging IEEE 802.1p for Class of Service IEEE 802.1X for Authentication IEEE 802.3ad for Port Trunk with LACP
Protocols	IGMP v1/v2 device, GMRP, GVRP, SNMP v1/v2C/v3, DHCP Server/Client, DHCP Option 66/67/82, BootP, TFTP, SNTTP, SMTP, RARP, RMON, HTTP, HTTPS, Telnet, SSH, Syslog, LLDP, IEEE 1588 PTP, IPv6, NTP Server/Client, EtherNet/IP, Modbus/TCP
MIB	MIB-II, Ethernet-like MIB, P-BRIDGE MIB, Q-BRIDGE MIB, Bridge MIB, RSTP MIB, RMON MIB Group 1, 2, 3, 9
Flow Control	IEEE802.3x flow control, back pressure flow control
<b>Switch Properties</b>	
Priority Queues	4
Max. Number of Available VLANs	64
VLAN ID Range	VID 1 to 4094
IGMP Groups	256
<b>Interface</b>	
Fast Ethernet	Front cabling, M12 connector, 10/100BaseT(X) auto negotiation speed, F/H duplex mode, and auto MDI/MDI-X connection
Gigabit Ethernet	Down cabling, M12 connector, 1000BaseLSX
Console Port	M12 A-coding 5-pin male connector
System LED Indicators	PWR1, PWR2, FAULT, MSTR/HEAD, CPLR/TAIL
Port LED Indicators	10/100M (Fast Ethernet port), 10/100/1000M (Gigabit Ethernet port), PoE
Alarm Contact	Two relay outputs in one M12 A-coding 5-pin male connector with current carrying capacity of 1 A @ 30 VDC
<b>Power Requirements</b>	
Input Voltage	WV: 24–110 VDC (16.8 to 137.5 VDC)
Input Current	TN-5510A-2GLSX-ODC Series: 0.45 A TN-5510A-8PoE-2GLSX-ODC Series: 7.8 A
Connection	M23, 6-pin male connector
Overload Current Protection	Present
Reverse Polarity Protection	Present



<b>Physical Characteristics</b>	
Housing	Metal, IP54 protection (with protective caps on unused ports)
Dimensions (W × H × D)	TN-5510A-2GLSX-ODC Series: 185 x 204.3 x 76.0 mm (7.28 x 8.04 x 2.99 in) TN-5510A-8PoE-2GLSX-ODC Series: 185 x 204.3 x 115 mm (7.28 x 8.04 x 4.53 in)
Weight	TN-5510A-2GLSX-ODC Series: 1,805 g TN-5510A-8PoE-2GLSX-ODC Series: 2,690 g
Installation	Panel mounting, DIN-Rail mounting (with optional kit)
<b>Environmental Limits</b>	
Operating Temperature	-40 to 75°C (-40 to 167°F)
Storage Temperature	-40 to 85°C (-40 to 185°F)
Operating Humidity	5 to 95% (non-condensing)
<b>Regulatory Approvals</b>	
Safety	UL/cUL 508
Rail Traffic	EN50155, EN50121-3-2, EN50121-4
EMI	FCC Part 15, CISPR (EN55022) class A
EMS	EN61000-4-2 (ESD), level 3 EN61000-4-3 (RS), level 3 EN61000-4-4 (EFT), level 3 EN61000-4-5 (Surge), level 3 EN61000-4-6 (CS), level 3 EN61000-4-8
Shock	IEC61373
Freefall	IEC60068-2-32
Vibration	IEC61373
<b>Note:</b> Please check Moxa's website for the most up-to-date certification status.	
<b>Warranty</b>	5 years Details: See <a href="http://www.moxa.com/warranty">www.moxa.com/warranty</a>

### **Technical Support Contact Information** **[www.moxa.com/support](http://www.moxa.com/support)**

Moxa Americas:

Toll-free: 1-888-669-2872

Tel: 1-714-528-6777

Fax: 1-714-528-6778

Moxa Europe:

Tel: +49-89-3 70 03 99-0

Fax: +49-89-3 70 03 99-99

Moxa China (Shanghai office):

Toll-free: 800-820-5036

Tel: +86-21-5258-9955

Fax: +86-21-5258-5505

Moxa Asia-Pacific:

Tel: +886-2-8919-1230

Fax: +886-2-8919-1231