

ioLogik E4200 User's Manual

Edition 4.1, September 2016

www.moxa.com/product



© 2016 Moxa Inc. All rights reserved.

ioLogik E4200 User's Manual

The software described in this manual is furnished under a license agreement and may be used only in accordance with the terms of that agreement.

Copyright Notice

© 2016 Moxa Inc. All rights reserved.

Trademarks

The MOXA logo is a registered trademark of Moxa Inc.
All other trademarks or registered marks in this manual belong to their respective manufacturers.

Disclaimer

Information in this document is subject to change without notice and does not represent a commitment on the part of Moxa.

Moxa provides this document as is, without warranty of any kind, either expressed or implied, including, but not limited to, its particular purpose. Moxa reserves the right to make improvements and/or changes to this manual, or to the products and/or the programs described in this manual, at any time.

Information provided in this manual is intended to be accurate and reliable. However, Moxa assumes no responsibility for its use, or for any infringements on the rights of third parties that may result from its use.

This product might include unintentional technical or typographical errors. Changes are periodically made to the information herein to correct such errors, and these changes are incorporated into new editions of the publication.

Technical Support Contact Information

www.moxa.com/support

Moxa Americas

Toll-free: 1-888-669-2872
Tel: +1-714-528-6777
Fax: +1-714-528-6778

Moxa Europe

Tel: +49-89-3 70 03 99-0
Fax: +49-89-3 70 03 99-99

Moxa India

Tel: +91-80-4172-9088
Fax: +91-80-4132-1045

Moxa China (Shanghai office)

Toll-free: 800-820-5036
Tel: +86-21-5258-9955
Fax: +86-21-5258-5505

Moxa Asia-Pacific

Tel: +886-2-8919-1230
Fax: +886-2-8919-1231

Table of Contents

1. Introduction	1-1
ioLogik Active Ethernet Modular I/O System Overview	1-2
Traditional Remote I/O	1-2
Active Ethernet Modular I/O	1-2
Product Features	1-3
Slice Form Factor, High Density Modular I/O	1-3
Greater Flexibility with Various I/O Module Choices	1-3
Expand to a Maximum of 256 Digital Input/Output Points	1-3
Auto Detection of Installed Modules	1-3
Event-based Logic with up to 80 Rules and Unicode Active Messaging	1-3
Dual Ethernet LAN Support	1-3
SMS Supported via a GPRS Modem	1-3
Built-in Web Console	1-3
Package Checklist	1-4
Product Descriptions	1-4
Network Adaptors	1-4
DC Digital Input Modules	1-4
AC Digital Input Modules	1-4
Digital Output Modules	1-4
Relay Output Modules	1-4
Analog Input Modules	1-4
Temperature Input Modules	1-5
Analog Output Modules	1-5
System Modules	1-5
Dimensions	1-5
Network Adaptor	1-5
I/O Module	1-6
Hardware Reference	1-6
Panel Guide	1-6
Hardware Specifications	1-7
LED Indicators	1-8
LED Indicators for Network Adaptors	1-8
LED Indicators for I/O Modules	1-8
2. Initial Setup	2-1
System Architecture	2-2
Installing an I/O Module on a DIN Rail	2-3
Removing the I/O Module from the DIN Rail	2-4
Removing the RTB (Removable Terminal Block) from the I/O Module	2-5
Installing the RTB on the I/O Module	2-5
Installing the System Power Module	2-5
Installing the Field Power Module	2-6
Connecting the Power System	2-7
Connecting to the Network	2-7
ioLogik E4200 Active Ethernet Network Adaptor	2-7
Configuring Your Network Architecture	2-8
3. Utilities	3-1
Introduction to Modular ioAdmin	3-2
Features of Modular ioAdmin	3-2
Getting Started	3-3
Functions on the Menu Bar	3-7
Navigation Panel	3-8
Server Context Menu	3-9
Quick Links	3-10
Main Window (General)	3-10
Administrator Functions	3-11
Using TFTP to Import/Export a Configuration	3-21
Using ioEventLog	3-22
Installing ioEventLog	3-22
Basic Functions	3-23
Main Menu	3-23
4. Using the Built-in Web Console	4-1
Overview for the ioLogik E4200	4-2
Entering the Web Console	4-2
Overview	4-3
Basic Settings	4-3
Network Settings	4-4
Adaptor Settings	4-4

Ethernet Configuration	4-4
Route Table	4-5
I/O Module	4-5
System Management	4-6
Accessible IP Settings	4-6
SNMP Agent	4-7
Network Connection	4-7
Firmware Update	4-8
Import System Config	4-8
Export System Config	4-8
Change password	4-9
Load Factory Default	4-9
Save/Restart	4-9
5. Click&Go Introduction	5-1
Overview	5-2
Features	5-3
Click&Go Logic Basics	5-3
Working with Rules	5-4
Developing Your Logic Rules	5-5
Define Global Variables	5-5
Internal Register Settings	5-5
Timer Settings	5-6
SNMP Trap Server	5-7
E-Mail Server	5-7
Active Message Settings	5-8
SMS Phone Number Book	5-9
IF/THEN/ELSE Statement	5-9
IF Conditions	5-10
THEN/ELSE Actions	5-12
Working with Click&Go Rulesets	5-16
Activating the Ruleset	5-16
Ruleset Management Bar	5-16
Ruleset Import/Export	5-16
A. Pinouts and Cable Wiring	A-1
Port Pinout Diagrams	A-1
Ethernet Port Pinouts	A-1
Serial Port Pinouts	A-1
B. Using Modbus/TCP	B-1
System Configuration Map Addresses	B-2
3xxxx Read only Registers (Support function 4)	B-2
4xxxx Read/Write Registers (support function 3, 6, 16)	B-3
I/O Image Map Addressing	B-8
Fixed mode (default mode):	B-9
Dynamic Mode	B-9
Module Configuration Map	B-10
DO Module Configuration Map	B-10
Input Register Map (R)	B-10
Holding Register Map (R/W)	B-10
Coil Map (R/W)	B-10
DI Module Configuration Map:	B-11
Input Register Map(R)	B-11
Holding Register Map(R/W)	B-11
AO Module Configuration Map	B-11
Input Register Map (R)	B-11
Holding Register Map (R/W)	B-11
AI Module Configuration Map	B-12
Input Register Map (R)	B-12
Holding Register Map (R/W)	B-12
TC Module Configuration Map:	B-12
Input Register Map (R)	B-12
Holding Register Map (R/W)	B-12
RTD Module Configuration Map	B-13
Input Register Map (R)	B-13
Holding Register Map (R/W)	B-13
Internal Registers	B-13
Function 8	B-13
C. CGI Commands	C-1
D. Network Port Numbers	D-1
E. SNMP MIB File	E-1

RFC1213 MIB-II supported SNMP variables:	E-2
Private MIB File and SNMP Variables	E-3
F. Factory Default Settings.....	F-1
G. FCC.....	G-1
FCC Statement	G-1
FCC Warning!	G-1

Introduction

The ioLogik Active Ethernet modular I/O family of advanced, slice-type network I/O products with local intelligence can connect sensors and on/off switches for automation applications over Ethernet and IP-based networks.

The following topics are covered in this chapter:

❑ **ioLogik Active Ethernet Modular I/O System Overview**

- Traditional Remote I/O
- Active Ethernet Modular I/O

❑ **Product Features**

- Slice Form Factor, High Density Modular I/O
- Greater Flexibility with Various I/O Module Choices
- Expand to a Maximum of 256 Digital Input/Output Points
- Auto Detection of Installed Modules
- Event-based Logic with up to 80 Rules and Unicode Active Messaging
- Dual Ethernet LAN Support
- SMS Supported via a GPRS Modem
- Built-in Web Console

❑ **Package Checklist**

❑ **Product Descriptions**

- Network Adaptors
- DC Digital Input Modules
- AC Digital Input Modules
- Digital Output Modules
- Relay Output Modules
- Analog Input Modules
- Temperature Input Modules
- Analog Output Modules
- System Modules

❑ **Dimensions**

- Network Adaptor
- I/O Module

❑ **Hardware Reference**

- Panel Guide

❑ **Hardware Specifications**

❑ **LED Indicators**

- LED Indicators for Network Adaptors
- LED Indicators for I/O Modules

ioLogik Active Ethernet Modular I/O System Overview

The ioLogik Active Ethernet modular I/O family of slice-type network I/O products can connect sensors and on/off devices in any combination and can transfer the captured data or device status to a host computer via an Ethernet or IP-based network.

ioLogik Active Ethernet modular I/O products consist of two main parts: (1) the network adaptor, and (2) I/O modules. The network adaptor provides system and field power to connected I/O modules. Up to 16 I/O modules can be connected to one network adaptor.

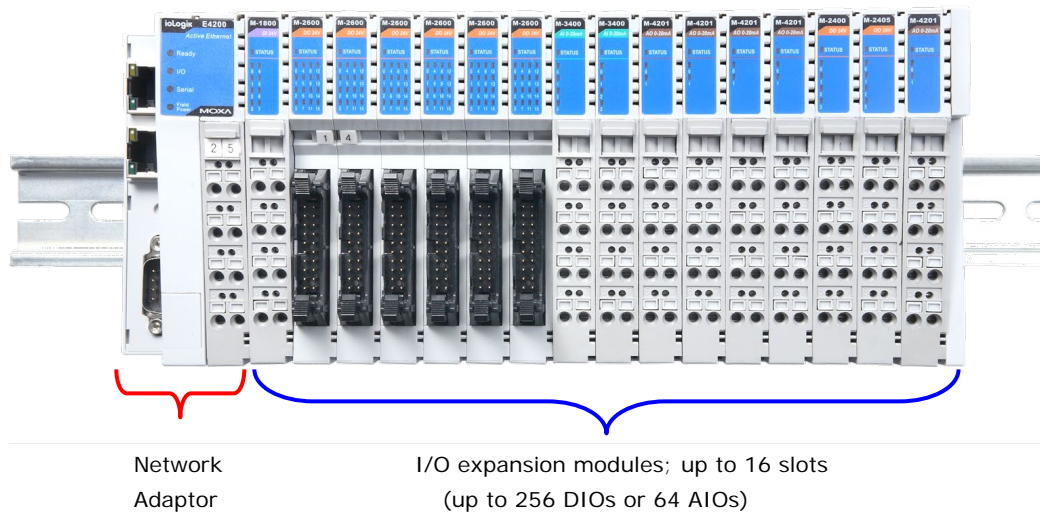

Traditional Remote I/O

Remote Ethernet modular I/O solutions have been on the market for a long time. Traditional solutions are “passive,” in the sense that I/O devices wait passively to be polled by a host computer. The response time in this type of setup, however, tends to be on the order of seconds. The “passive” remote modular I/O structure is inadequate for data acquisition and control systems that require an efficient, real-time I/O solution with a response time on the order of hundredths of a second.

Active Ethernet Modular I/O

Moxa’s Active Ethernet modular I/O solutions were developed specifically to address the limitations of the traditional passive approach. With the passive approach, the host computer polls the I/O device over the network for the status of each I/O device. With the active approach, the Active Ethernet modular I/O product intelligently sends the host computer status information only when specified events occur. Using push technology, the ioLogik I/O device greatly reduces the load on the CPU and network resources. Far fewer network packets are required and in general the packets are smaller in size since I/O information is only sent when needed, and only information from the specified I/O device is sent.

Moxa’s active I/O messaging system uses TCP or UDP for I/O messaging and supports sending messages to up to ten host computers simultaneously. In addition to providing intelligent status reporting, Active Ethernet I/O products are backwards compatible. That is, they support all of the functions and capabilities of traditional passive remote I/O products.

Product Features

Slice Form Factor, High Density Modular I/O

The ioLogik E4200's compact design is well-suited for environments with limited space. The amount of space needed at the installation site is determined by the number of modules used. For example, the I/O system's width is only 117 mm if you are using 5 I/O modules, compared to 231 mm for an I/O with an 8 slot backplane design.

Greater Flexibility with Various I/O Module Choices

The ioLogik E4200 Active Ethernet modular I/O family supports various types of I/O modules, including DC digital input, AC digital input, digital output, relay output, analog input, and analog output.

Expand to a Maximum of 256 Digital Input/Output Points

The ioLogik Active Ethernet I/O family can support up to 16 modules. In other words, the family can support up to 256 digital input/output points or 64 analog input/output points.

Auto Detection of Installed Modules

A utility provided by Moxa automatically detects and displays all of the modules that are installed. This feature allows users to see exactly what is installed.

Event-based Logic with up to 80 Rules and Unicode Active Messaging

Active Ethernet modular I/O products come pre-installed with 80 rules of event-based logic. All alarm messages also support Unicode text.

Dual Ethernet LAN Support

For reliability, ioLogik products have two independent Ethernet ports with two MAC addresses and two IP addresses.

SMS Supported via a GPRS Modem

Alarm messages can be automatically sent through the RS-232 COM port when the I/O is connected to a GPRS modem, such as Moxa's OnCell 2111 or OnCell 2151.

Built-in Web Console

The ioLogik E4200 includes a pre-installed web console that allows you to monitor the I/O status via a web browser.

Package Checklist

Each network adaptor and I/O module is packed securely in a small box.

If you ordered a network adaptor, the package includes:

- ioLogik E42xx Active Ethernet network adaptor
- End module cover
- Quick installation guide (printed)

If you ordered an I/O module, the package includes:

- M-xxxx I/O module x 1

NOTE: Please notify your sales representative if any of the above items are missing or damaged.

Product Descriptions

Detailed specifications for the ioLogik E4200 are available in the software's product specification help file. Refer to the help file for more information. Models supported by this manual are:

Network Adaptors

ioLogik E4200	Dual Ethernet LAN, RS-232, Active Ethernet network adaptor
----------------------	--

DC Digital Input Modules

M-1800	8 digital inputs, sink, 24 VDC, removable terminal block
M-1801	8 digital inputs, source, 24 VDC, removable terminal block
M-1600	16 digital inputs, sink, 24 VDC, 20-pin header
M-1601	16 digital inputs, source, 24 VDC, 20-pin header

AC Digital Input Modules

M-1450	4 digital inputs, 110 VAC, removable terminal block
M-1451	4 digital inputs, 220 VAC, removable terminal block

Digital Output Modules

M-2800	8 digital outputs, sink, 24 VDC, 0.5 A, removable terminal block
M-2801	8 digital outputs, source, 24 VDC, 0.5 A, removable terminal block
M-2600	16 digital outputs, sink, 24 VDC, 0.3 A, 20-pin header
M-2601	16 digital outputs, sink, 24 VDC, 0.3 A, 20-pin header

Relay Output Modules

M-2250	2 relay outputs, Form A (N.O.), 2 A, removable terminal block (phased out in May 2009)
M2450	4 relay outputs, Form A (N.O.), 2 A, removable terminal block

Analog Input Modules

M-3802	8 analog inputs, 4 to 20 mA, 12-bit, removable terminal block
M-3810	8 analog inputs, 0 to 10 V, 12-bit, removable terminal block

Temperature Input Modules

M-6200	2 analog inputs, RTD, removable terminal block
M-6201	2 analog inputs, thermocouple, removable terminal block

Analog Output Modules

M-4202	2 analog outputs, 4 to 20 mA, 12-bit, removable terminal block (phased out in May 2009)
M-4210	2 analog outputs, 0 to 10 V, 12-bit, removable terminal block (phased out in May 2009)
M-4202	2 analog outputs, 4 to 20 mA, 12-bit, removable terminal block
M-4210	2 analog outputs, 0 to 10 V, 12-bit, removable terminal block

System Modules

M-7001	System expansion power supply, 1.0 A (5 VDC)
M-7002	Field power distributor, 10 A (24/48 VDC, 110/220 VDC)
M-7804	Potential distributor, 8-ch, 0 VDC
M-7805	Potential distributor, 8-ch, 24 VDC

Dimensions

Network Adaptor

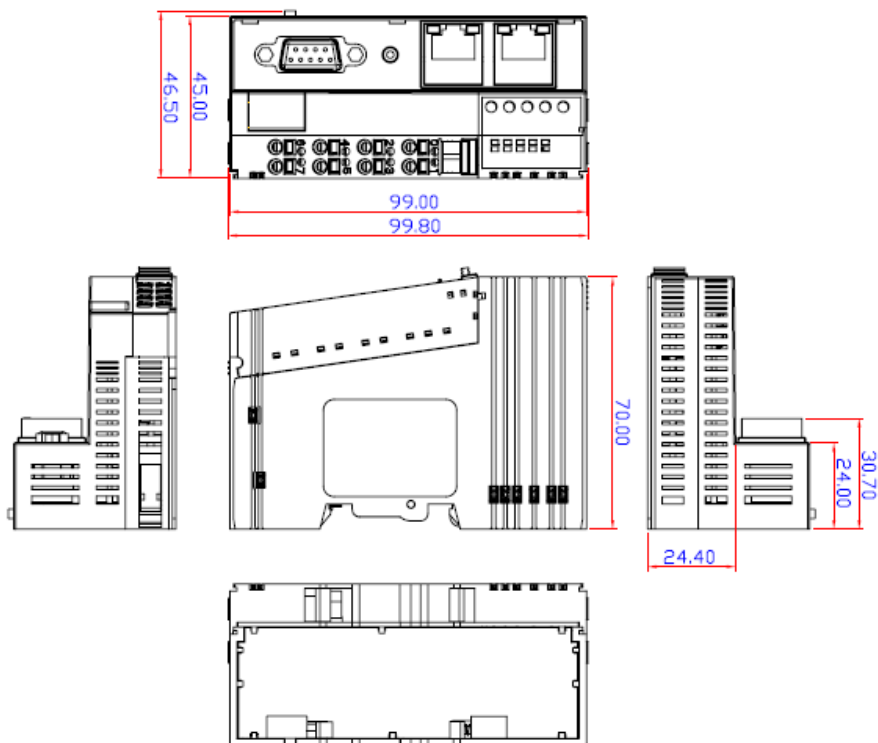

Unit: mm; W x H x D: 45 x 99.8 x 70 mm

I/O Module

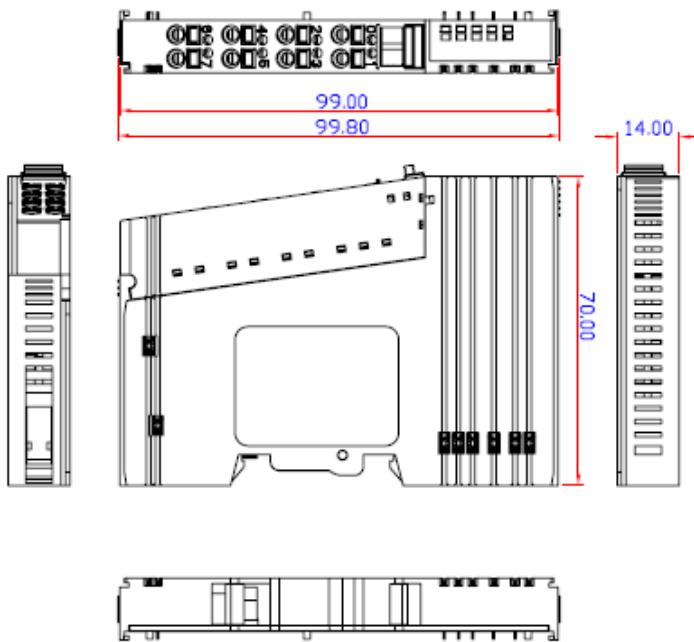

Unit: mm; W x H x D: 14 x 99.8 x 70 mm

Hardware Reference

Panel Guide

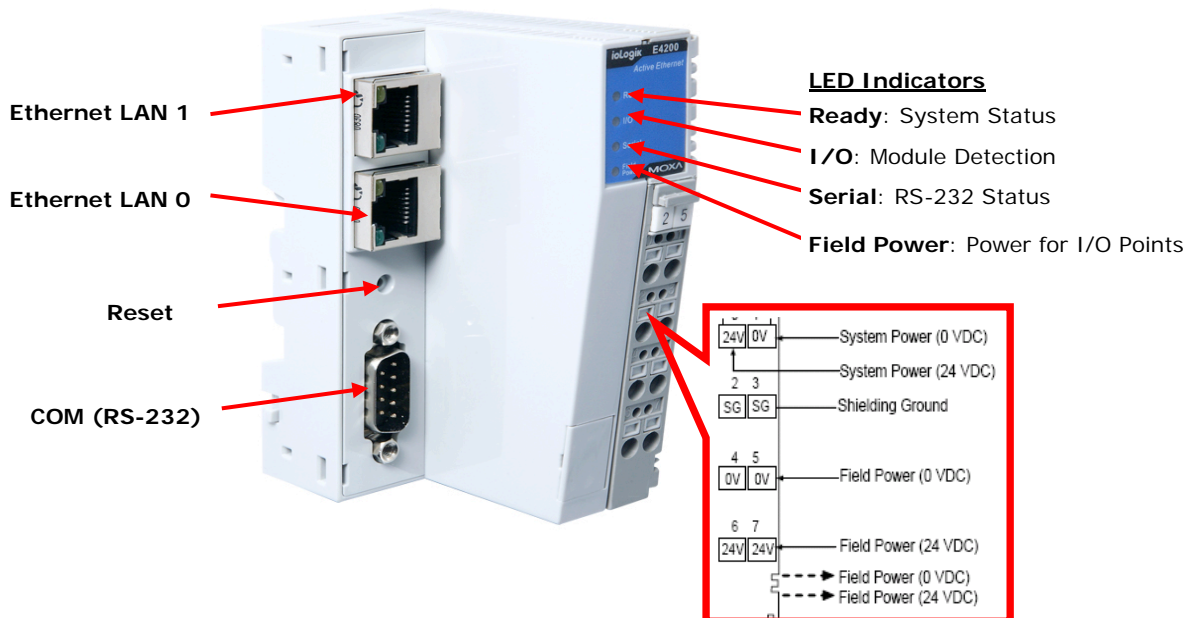

NOTE The reset button restarts the system and resets all settings to factory defaults. Use a pointed object such as a straightened paper clip to hold in the reset button down for 5 sec. The READY LED will turn red as you are holding the reset button down. The factory defaults will be loaded once the READY LED turns green again. You may then release the reset button.

Hardware Specifications

LAN

Ethernet: 2 x 10/100 Mbps: 2 MACs, 2 IPs, RJ45 connectors

Protection: 1.5 KV magnetic isolation

Protocols: Modbus/TCP, TCP/IP, UDP, DHCP, Bootp, SNMP, HTTP, SNTP, SMTP

Serial Communication

Interface: 1 x RS-232 (9-pin D-Sub, male)

Parameters: N, 8, 1

Baudrate: 115,200 bps

Power Requirements

Power Input: 24 VDC nominal, 12 to 36 VDC

Power Consumption: 175 mA @ 24 VDC

Current for I/O Modules: Max. 1.5A @ 5 VDC

Field Power

Rated Voltage: 11 to 28.8 VDC, 24 VDC typical

Current in Field Power Contact: Max. 10 A

Isolation

System Power to I/O Driver: Optical isolation, 3k VDC or 2k Vrms

Physical Characteristics

Dimensions: 45 x 99 x 70 mm (1.77 x 3.90 x 2.76 in)

Note: Please see pages 15-23 for the dimensions diagram.

Weight: 180 g

Mounting: DIN rail

Environmental Limits

Operating Temperature: -10 to 60°C (14 to 140°F)

Storage Temperature: -40 to 85°C (-40 to 185°F)

Ambient Relative Humidity: 5 to 95% (non-condensing)

Altitude: Up to 2000 m

Note: Please contact Moxa if you require products guaranteed to function properly at higher altitudes.

Standards and Certifications

Safety: UL 508

EMI:

61000-3-2; EN 61000-3-3; EN 61000-6-4; FCC Part 15, Subpart B, Class A

EMS:

EN 61000-4-2, EN 61000-4-3, EN 61000-4-4,

EN 61000-4-5, EN 61000-4-6, EN 61000-4-8,

EN 61000-6-2, IEC 61000-4-11

Shock: IEC 60068-2-27

Freefall: IEC 60068-2-32

Vibration: IEC 60068-2-6

Green Product: RoHS, CRoHS, WEEE

Note: Please check Moxa's website for the most up-to-date certification status.

MTBF (mean time between failure)

Time: 357,000 hrs

Database: Telcordia (Bellcore)

Warranty

Warranty Period: 2 years

Details: See www.moxa.com/warranty

LED Indicators

LED Indicators for Network Adaptors

Group	Pins/Description	Printed label
Ethernet	On the Plug	
Ready	Green: The power is on and the system is working normally Green-Flashing: Click&Go is active Red-Flashing: System error Off: No power	Ready
I/O	OFF: The I/O module is not installed Green: Connecting to the I/O module Green-Flashing: Data is being transmitted Red: Safe mode (implies host connection failure) Red-Flashing: Safe mode (implies I/O module failure)	I/O
Serial	Green: Tx Yellow: Rx Red: Data transmission failure	Serial
Field Power	Green: Normal input of 11 to 28.8 V Red: Voltage out of range	Field power

LED Indicators for I/O Modules

Each DIO or AIO module is equipped with a Module Status LED indicating operation status.

LED Name	LED Color	LED Function
Status	Off	Was not powered on during initialization
	Green	Steady On: System ready Flashing: I/O module ready for data transmission
	Red	Steady On: I/O module hardware problem Flashing: System bus data transmission error

In this chapter, we explain how to install the Ethernet network adaptor and I/O modules.

The following topics are covered in this chapter:

- ❑ **System Architecture**
- ❑ **Installing an I/O Module on a DIN Rail**
- ❑ **Removing the I/O Module from the DIN Rail**
- ❑ **Removing the RTB (Removable Terminal Block) from the I/O Module**
- ❑ **Installing the RTB on the I/O Module**
- ❑ **Installing the System Power Module**
- ❑ **Installing the Field Power Module**
- ❑ **Connecting the Power System**
- ❑ **Connecting to the Network**
 - ioLogik E4200 Active Ethernet Network Adaptor
 - Configuring Your Network Architecture

System Architecture

The ioLogik E4200 modular I/O consists of a network adaptor that supports Ethernet and up to 16 I/O modules.

- The ioLogik E4200 Active Ethernet network adaptor is the brains of the system. It is responsible for collecting information from each I/O module and deciding what parameters to use to operate the I/O module. Communication between the network adaptor and I/O modules is achieved by a system communication bus.
- Modbus addresses for each I/O channel are arranged dynamically by the network adaptor according to the installed I/O modules.
- The network adaptor requires two sets of 24 VDC power inputs. One is for the internal logic circuit, and the other is for field I/O circuits.
- The network adaptor provides 5 VDC power to all connected I/O modules. When the total current consumption of the I/O modules exceeds 1.5 A, you will need to insert an extra power expansion module. To determine how many power expansion modules are required, refer to the spreadsheet in **Program Files** → **MOXA** → **IO Server** → **HELP**.

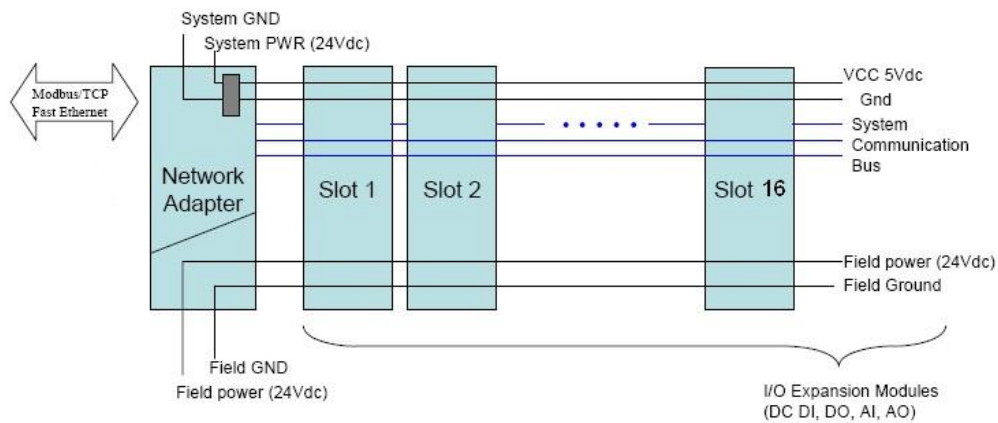

Installing an I/O Module on a DIN Rail

Step 1: Align the I/O module side by side with the network adaptor, making sure that the upper and lower rails are hooked together.

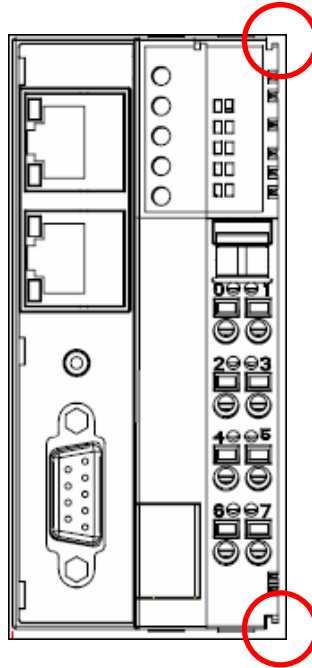

Step 2: Align the I/O module side by side with the network module and then push the I/O module until it touches the DIN rail. Next, apply more force until the module clips on to the DIN rail.

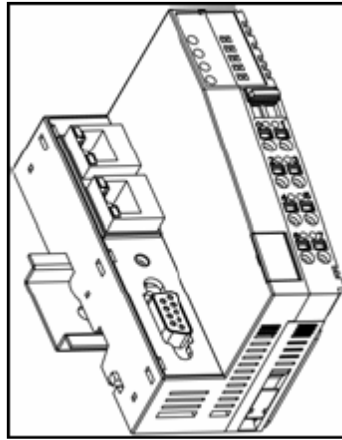
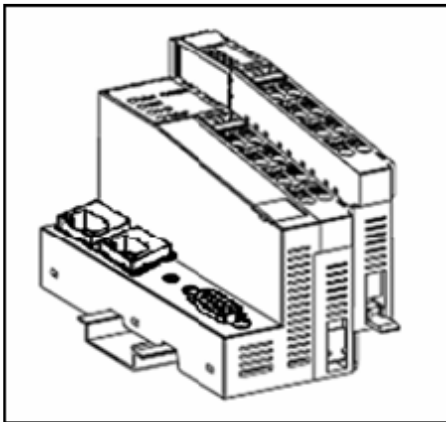

Removing the I/O Module from the DIN Rail

Step1: Use your finger or a screw driver to pull down the tab on the lower part of the module.

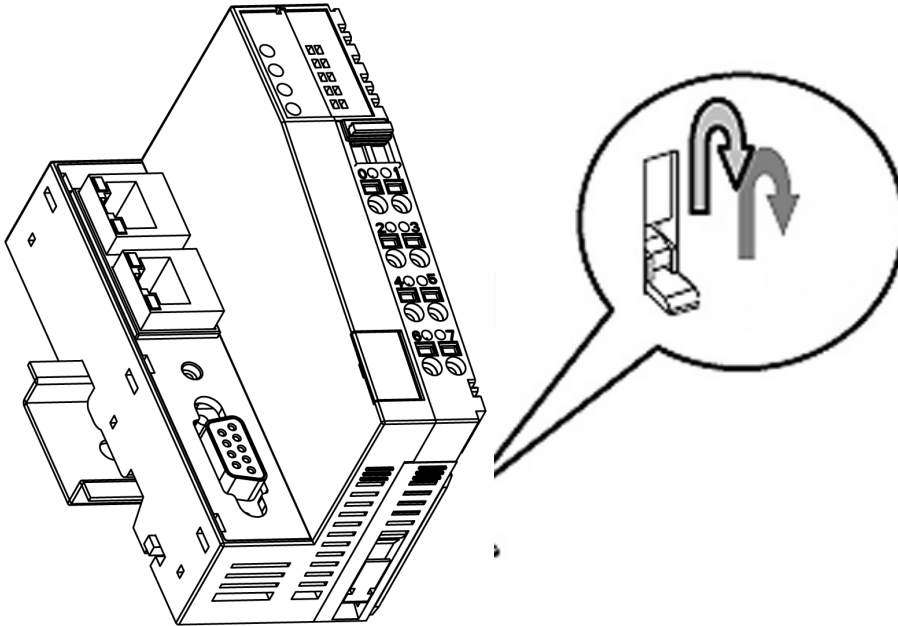

Step2: While still holding down the tab, pull out the module.

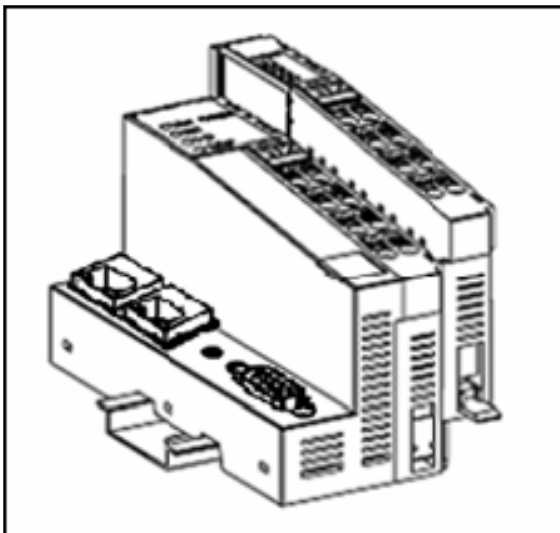

Removing the RTB (Removable Terminal Block) from the I/O Module

Pull out the plastic belt from the RTB, and then apply more force until the I/O module is pulled away from the I/O module.

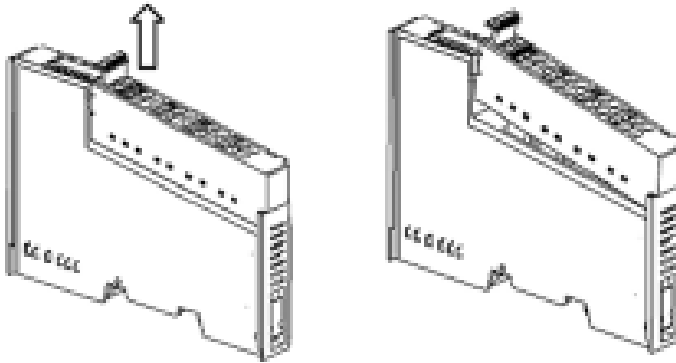

Installing the RTB on the I/O Module

Step1: Hook the bottom end of the RTB to the I/O module.

Step2: Push down the RTB until it fits snugly on the I/O module, and then push in the plastic belt.

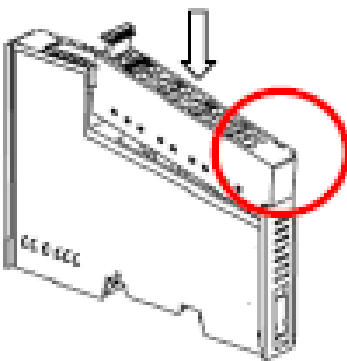

Installing the System Power Module

The system power expansion module is designed to provide extra power when additional I/O expansion modules are connected. Each ioLogik E4200 can provide 1.5 A @ 5 VDC. If you require more power for your installed I/O modules, you will need to use an M-7001 module. However, please note that the M-7001 can only provide 1 A @ 5 VDC.

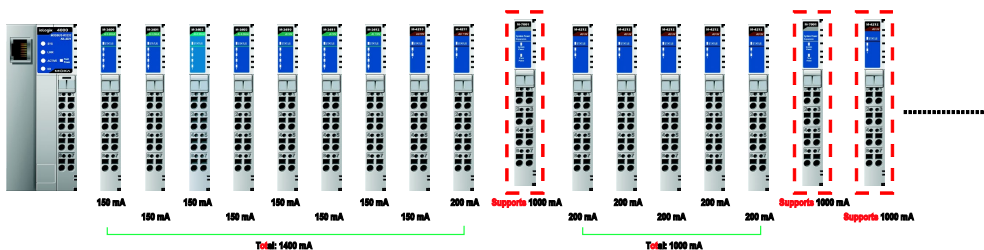



ATTENTION

When the total current consumption for connected I/O modules exceeds 1.5A, an M-7001 power expansion module is required.

To determine if an additional power expansion module is needed, open the Power Consumption Spreadsheet located here: **Program Files → MOXA → IO Server → HELP**. The spreadsheet requires Microsoft Excel to operate. Once you enter the I/O module quantity, the spreadsheet will compute automatically how many power expansion modules are required.

When extra power expansion modules are installed, restart the system in the following sequence to ensure a proper start-up.

Power Off Sequence

1. Unplug the network adaptor's removable terminal block.
2. Unplug the expansion module's removable terminal block.

Power Up Sequence

1. Plug in the power expansion module's removable terminal block.
2. Plug in the network adaptor's removable terminal block.



ATTENTION

The "End Module" should be covered to prevent unexpected damage to exposed data pins.

Installing the Field Power Module

The field power distributor is designed to isolate different field voltages. Most of the field power DIO/AIO modules for the ioLogik E4200 series are 24 VDC. If you need to connect 110 VAC, 230 VAC digital input or output modules, you must use the Field Power Distributor to isolate different field powers within a single ioLogik E4200 system.

If all of the DIO modules are 110 VAC, you will need at least one field power distributor to isolate the field power from the network adaptor (likewise when using 24 VDC or 230 VAC). For example, before you connect a 110 VDC or 220 VAC AC digital input module to a 24 VDC DI/O module, you will need an M-7002 field power distributor.

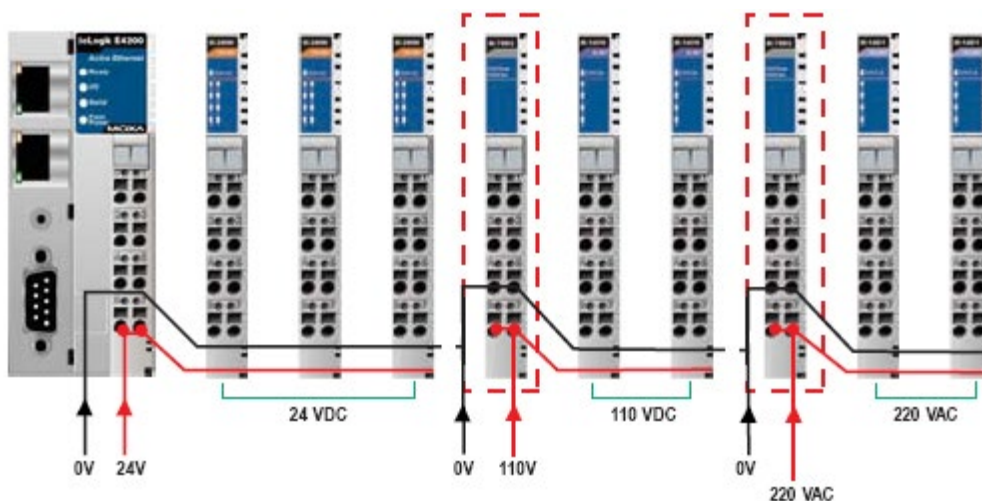

Some types of Potential Distributor modules provide extra wiring points such as shielding ground, 0 V field power, and 24 V field power. For example, the 8-channel digital input (sink type) module itself does not have a 24 V wiring point, but you can add a 24 V potential distributor for easy wiring.

Connecting the Power System

Two 24 VDC power sources are required to power the ioLogik E4200. One 24 VDC power input is for system power, and the other 24 VDC power input is for the field I/O. For field installation, system power and field power are provided by different power supply systems.

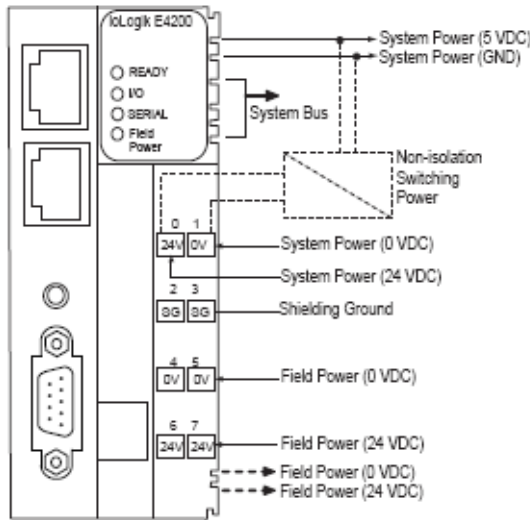

System power:

24 VDC nominal, 11 to 28.8 VDC

Power dissipation:

60 mA @ 24 VDC

Current for I/O module:

1.5 A @ 5 VDC

Field power:

11 to 28.8 VDC

Max. current for field power contact:

DC 10 A max.

I/O Cable Gauge:

AWG14 to AWG28



ATTENTION

Determine the maximum possible current for each power wire and common wire. Observe all electrical codes dictating the maximum current allowed for each wire size. If the current exceeds the maximum rating, the wiring could overheat, causing serious damage to your equipment. For safety reasons, we recommend an average cable size of 22 AWG. However, you may want to use a different cable size depending on the current load (the maximum wire size for power connectors is 2 mm).

Connecting to the Network

ioLogik E4200 Active Ethernet Network Adaptor

The ioLogik E4200 Active Ethernet network adaptor supports standard 10/100 Mbps Ethernet. For first time users, we recommend that you link from your host computer to the ioLogik E4200 over a local Ethernet network to take care of IP and system configuration. Once the installation is done, you may move the entire I/O system to the field. Note that you can insert any LAN port to make the configuration setting work.

1. Connect the ioLogik E4200 to the host PC with an Ethernet cable. For initial setup of the ioLogik E4200, we recommend configuring the ioLogik E4200 using a direct connection to a host computer, rather than remotely over the network.

Note: While configuring the device, only use one connection. To prevent unexpected errors from occurring, do not use two connections to connect the ioLogik E4200.

2. If you connect to the host PC through LAN 0, configure the host PC's IP address to 192.168.127.xxx, with xxx ranging from 001 to 253). If you connect to the host PC through LAN 1, configure the host PC's IP address to 192.168.126.xxx, with xxx ranging from 001 to 253).

In Windows, you will need to do this from the Control Panel.

LAN Port	Default IP Address	Default Netmask	Default Gateway
LAN 0	192.168.127.254	255.255.255.0	None
LAN 1	192.168.126.254	255.255.255.0	None

- Use Modular ioAdmin or the web console to detect the ioLogik E4200. Once the ioLogik E4200 has been detected, modify the settings as needed for your network environment, and then restart the I/O.

Configuring Your Network Architecture

After connecting the ioLogik E4200, you will need to configure the network. Refer to the following figure for an example.

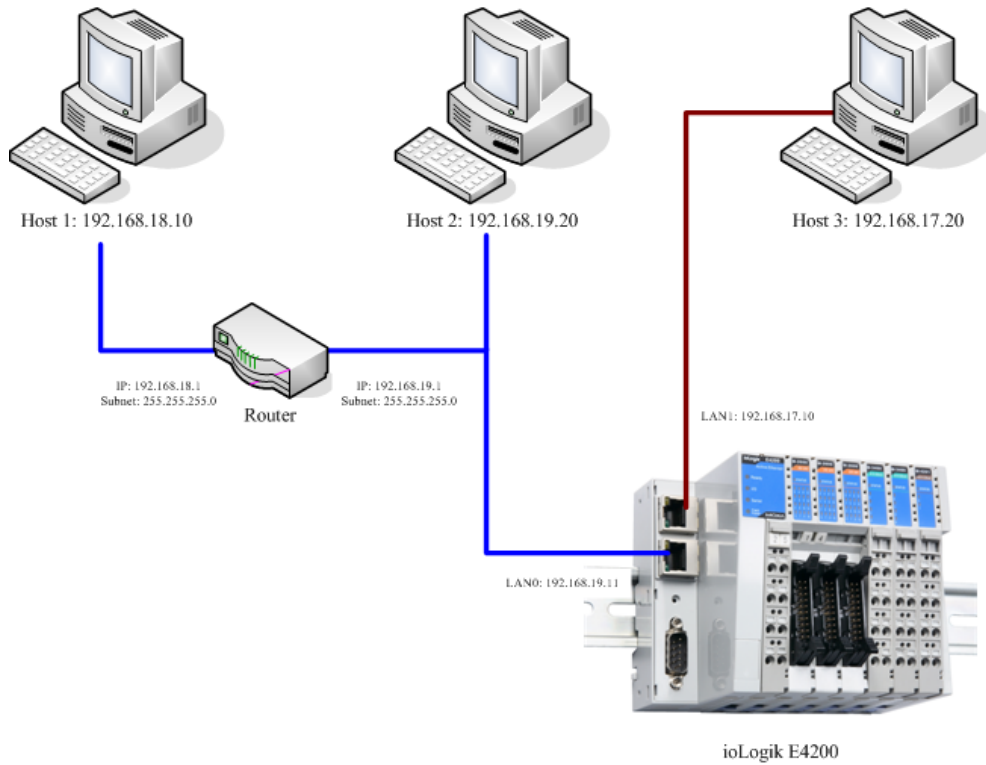

To manage the ioLogik E4200 from Host 1, use the parameters in the following table to add a routing rule to the ioLogik E4200's routing table:

Destination	192.168.18.10
Network-Mask	255.255.255.255
Gateway	192.168.19.1
Interface	LAN-0

To allow all hosts on subnet 192.168.18.x to connect to this ioLogik E4200, use the parameters in the following table to add a routing rule to the ioLogik E4200's routing table:

Destination	192.168.18.0
Network-Mask	255.255.255.0
Gateway	192.168.19.1
Interface	LAN-0

In this chapter, we introduce software utilities you can use when configuring the Windows-based ioLogik Active Ethernet modular I/O system. The software utilities include:

1. **Modular ioAdmin:** The main utility that allows you to configure, monitor, and edit Click&Go.
2. **TFTP:** The utility that allows you to mass deploy the configuration file.
3. **ioEventLog:** The utility that allows you to determine the system cold-start/warm-start status and time.

The following topics are covered in this chapter:

▣ Introduction to Modular ioAdmin

- Features of Modular ioAdmin
- Getting Started
- Functions on the Menu Bar
- Navigation Panel
- Server Context Menu
- Quick Links
- Main Window (General)
- Administrator Functions

▣ Using TFTP to Import/Export a Configuration

▣ Using ioEventLog

- Installing ioEventLog
- Basic Functions
- Main Menu

Introduction to Modular ioAdmin

The ioLogik Modular I/O can be managed and configured over the Ethernet using Modular ioAdmin, a Windows utility provided with your ioLogik E4200. Modular ioAdmin's graphical user interface gives you easy access to all status information and settings. Although the ioLogik E4200 also supports configuration by web console, full configuration and management is only available through Modular ioAdmin. It has the following functions:

- **Full function setting**
- **Click&Go Logic**
- **The Wiring Guide**

Features of Modular ioAdmin

Auto Search and Detection

When you connect to the ioLogik E4200, the utility can automatically determine how many devices are connected to the network. A picture of each installed module will be displayed on the screen after successfully logging in. You do not need to add I/O modules manually one by one. All of the devices you've installed will appear onscreen. In addition, ioAdmin will resolve any IP conflicts that arise from installing two or more ioLogik Active Ethernet modular I/Os at the same time.

Remote Management

Over an Ethernet network, Modular ioAdmin allows users to find and configure multiple ioLogik systems, and monitor and configure attached I/O devices. You can also test I/O devices and reset the system.

Click&Go Logic Editor

Click&Go is an event-based, front-end intelligent logic that allows you to make your I/O system smarter. Modular ioAdmin also includes a Click&Go event logic editor for configuring the control logic of your Active Ethernet I/O system.

On-line Wiring Guide

An on-line wiring guide can be opened from within Modular ioAdmin. The easily accessible wiring guide can significantly reduce the amount of time administrators need to devote to planning and troubleshooting.

Import/Export files

Modular ioAdmin can generate three types of files automatically: (1) system configuration files, (2) server lists, and (3) Modbus tables.

- This function can import/export configuration files and server management lists.
- Modular ioAdmin allows the entire configuration of the ioLogik I/O system to be saved as a file. The file is viewable as text and can serve as a record for configuration backup, or as a template for configuring other ioLogik devices.
- The file includes title, date, time, model information, and Click&Go rules.
- Modular ioAdmin can also import and export a list of ioLogik devices that are being managed. The list makes it easier to manage all devices on the network, and includes server name, module type, IP address, and unit ID.
- This function can also export the Modbus tables, which are generated automatically.

If two or more I/O systems with the same IP address are found, Modular ioAdmin will ask you to modify IP addresses in a pop-up window, and then reboot the I/O system. For example, if multiple ioLogik E4200 units are initially installed on the same network, each unit has the same default IP address. You will need to assign a different IP address to each unit to avoid IP conflicts. Modular ioAdmin automatically detects IP conflicts and gives you a chance to modify each unit's IP address in the **IP Address** column. Click the **Set** button to reboot the corresponding unit with its new IP address. Click the **Re-Search** button to refresh the list of units found by Modular ioAdmin.

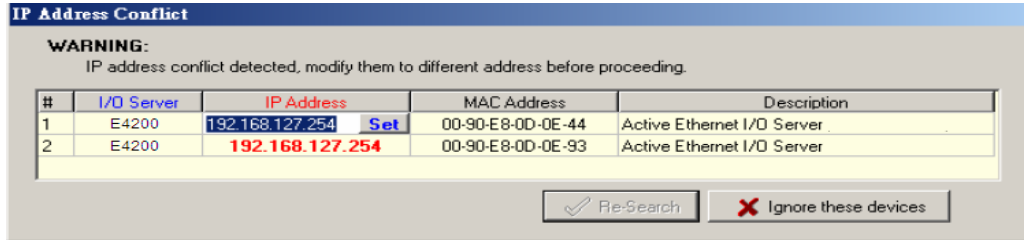

In certain situations, Modular ioAdmin will be unable to detect the existing I/O system, such as when the I/O system is not on the same network segment. In these cases, you can add the systems manually. Right click the tag of the **ioLogik** in the Navigation Panel, and then choose **Add ioLogik I/O Adaptor** in the pop-up window and key in the correct I/O system IP address.



ATTENTION

If multiple network interfaces are installed on a host computer, be sure to select the correct one before searching from **menu bar** → **system** → **Network Interface**.

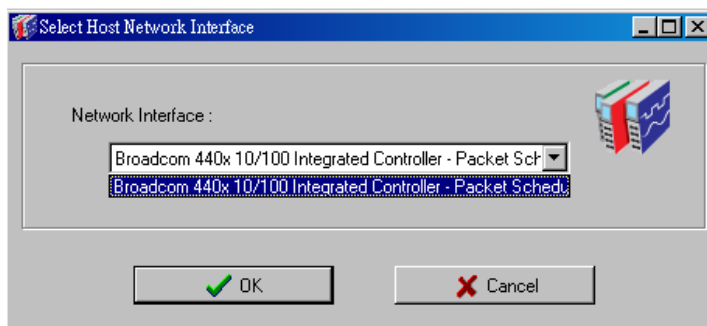

After the ioLogik E4200 is displayed in the main window, select **Adaptor Settings** and then click **login**. The I/O modules will be automatically detected and shown on the main window of the **I/O configuration** tab.



ATTENTION

If this is not a first-time installation, the **Module Order Error** window might appear. If the initial installation is successful, the ioLogik E4200 will memorize all settings and current module combinations. If the module combination changes, the ioLogik E4200 will detect an unmatched module combination event and show a warning window as pictured below.

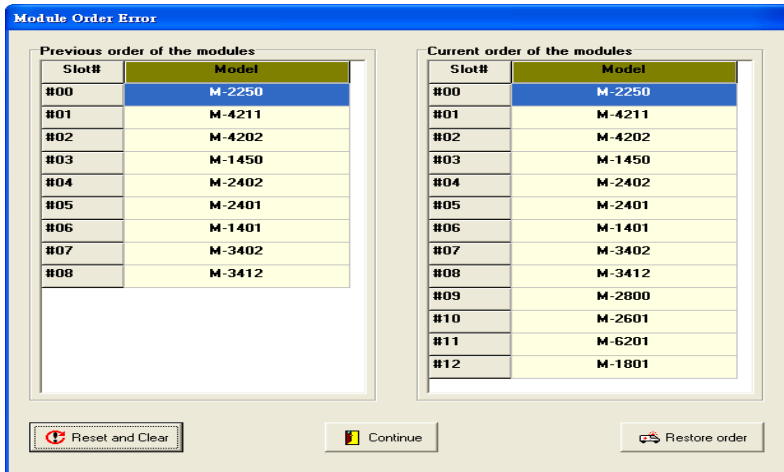

Three options are available for handling unmatched module combination events:

Reset and Clear:

If you know the I/O modules combination has changed, then choose this option. This action resets all module configurations, clears all Click&Go logic, and restarts the system.

Continue:

If you have just added new I/O modules onto the end of the existing I/O system, then choose this option. This action does not clear Click&Go settings, it only stops it; you can still re-start it, but at your own risk. All configurations of previously installed modules are preserved, and newly added modules will be applied with default settings.

Restore order (recover the previous module combination)

If you **don't** know why the I/O modules combination has changed, then choose this option. You need to shut down the system's power, and then reset the module combination to the previous settings individually.

Modular ioAdmin Main Screen

This is Modular ioAdmin's main screen. The main window defaults to the **I/O Configuration** tab, which displays a figure of the ioLogik E4200 and the status of every I/O channel below it. The other tabs in the main window take you to device and network settings, and further functions are available when you log on as an administrator. Note that configuration options are not available until you log on as an administrator.

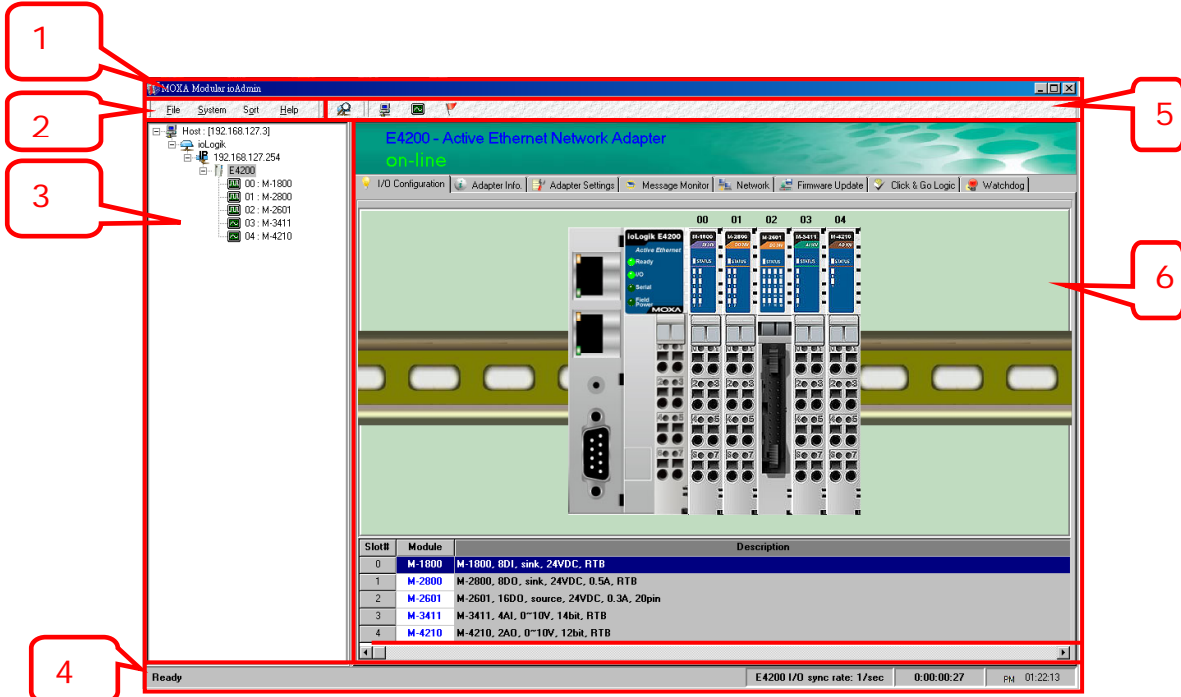

1	Modular ioAdmin Title
2	Menu Bar
3	Navigation Panel
4	Status Bar
5	Quick Link
6	Main Window

Wiring Guide

Modular ioAdmin provides a wiring guide to the ioLogik Active Ethernet modular I/O. You may access the wiring guide by right-clicking the figure of the ioLogik E4200 or **I/O Module** in the **I/O Configuration** tab. Select **Wiring Guide** in the submenu to open a help file showing the wiring information and electrical characteristics of the ioLogik E4200.

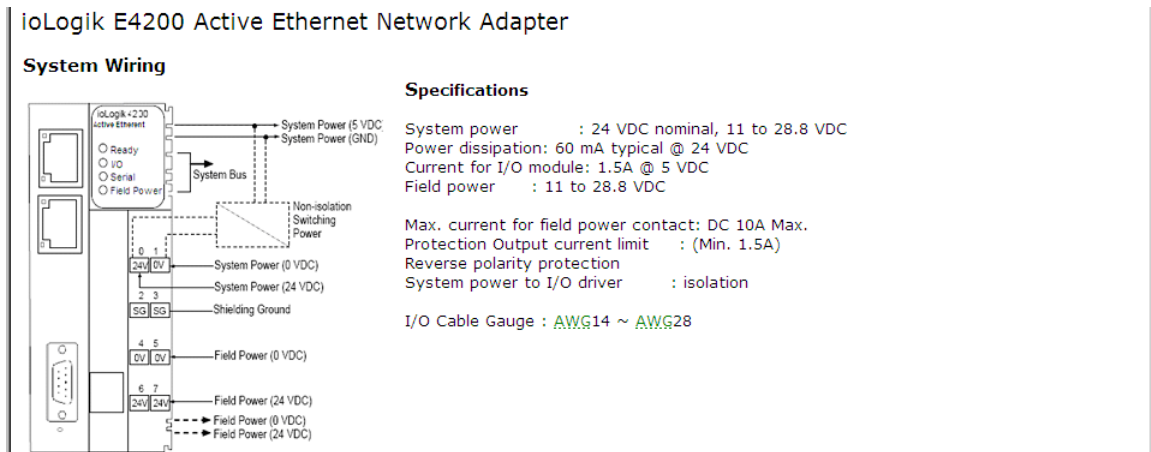

Functions on the Menu Bar



File

From the **File** menu, you can export the **Server List**, which contains a list of ioLogik devices that are currently displayed in the navigation panel. You also can import a list of ioLogik I/Os into Modular ioAdmin.

When importing a server list, you will be prompted to select which I/O devices on the list need to be imported. The file will have an .SLT extension and can be opened as a text file.

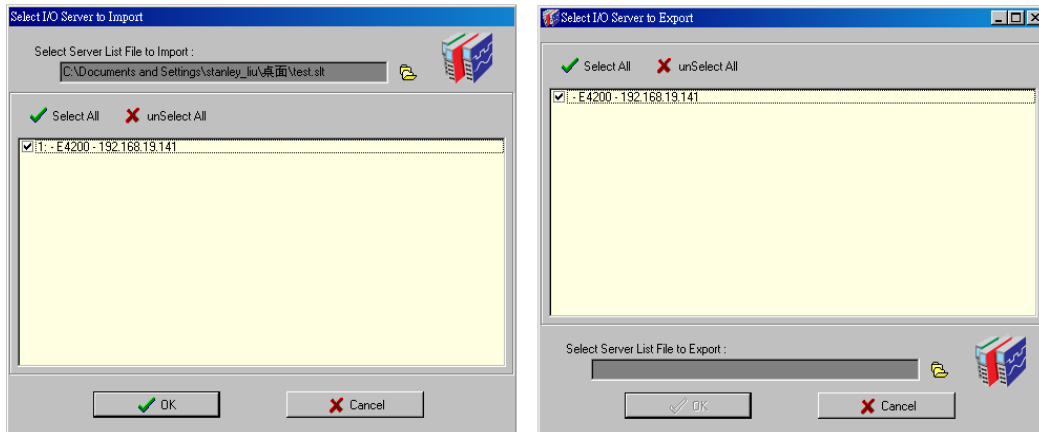

The server list will provide the following information for each adaptor:

- Adaptor name
- Module type
- IP address

System

Several operations are possible from the **System** menu.

Auto Scan Active Ethernet Network Adaptor will search for ioLogik devices on the network. When connecting for the first time or recovering from a network disconnection, you can use this command to find I/O systems that are on the network.

Network Interface allows you to select a network to use if the PC has multiple network adaptors installed.

If you can't find the Network Adaptor, try specifying the network interface the host uses to connect to the Network Adaptor.

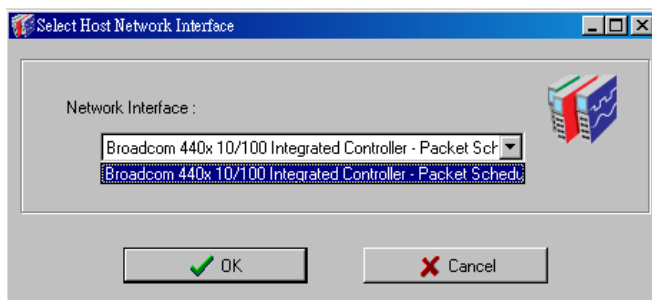

I/O Status Refresh Interval is used to adjust how often the I/O system synchronizes with Modular ioAdmin for I/O system status. The current rate is displayed on **Sync. Rate Information** at the bottom of the window. Note that higher sync rates result in higher loads on the network. The default value is 50 (500 msec.). To

change the configuration, click **I/O Status Refresh Interval** under the **System** menu, and then adjust the data refresh rate. Note that the unit is in 10 msec increments, so if you enter 100, the refresh rate becomes 1 sec.

TCP Socket Timeout Interval allows you to select the preferred timeout value for TCP socket communication.

Active Message Listen Port specifies the port number to use for Active Ethernet I/O messages. If your network uses a firewall, you can coordinate this setting with your firewall settings to ensure that active messages get through. The default Listen Port is 9001.

Sort

The **Sort** menu allows the server list in the navigation panel to be sorted by connection, type, and location.

They are sorted by Adaptor Location by default. You can also change the sorting method through the sorting function or Quick Link. You can sort by connection, location, or type.

Help

Use the **Help** menu to can view wiring guides and information about Modular ioAdmin.

Navigation Panel

On this panel, Modular ioAdmin will show you the information for the Host IP, and how many I/Os are in your system.

Right clicking on the ioLogik tag will allow you to manually add ioLogik Adaptor. Choose **Add ioLogik I/O Adaptor** and then in the pop-up window key in the I/O system IP address that you want to add.

Right click on the E4200 tag and the Server Context Menu will pop up. This allows you to execute Connect/Disconnect, Delete I/O Adaptor, Restart System, Reset to Default, and Import/Export file functions.

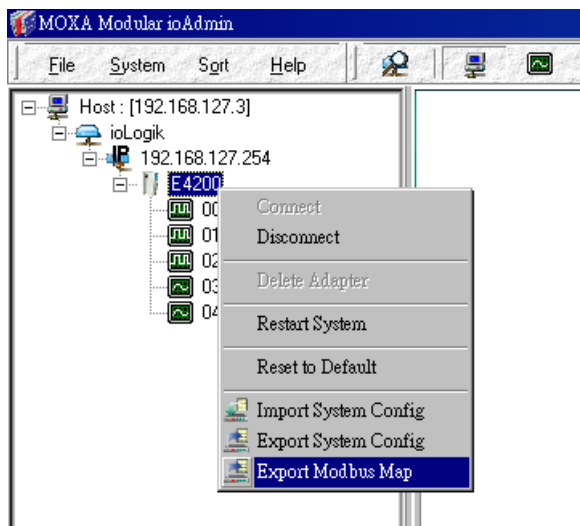

Server Context Menu

The server context menu is accessed by right clicking on the server model name in the navigation panel.

Connect

Select this command if you want Modular ioAdmin to attempt to reconnect over the network to the selected ioLogik I/O.

Disconnect

Select this command if you want Modular ioAdmin to drop the network connection with the selected ioLogik I/O.

Delete Adaptor

Select this command if you want Modular ioAdmin to remove the selected I/O system.

Restart System (Administrator Function)

Select this command to restart your ioLogik I/O system from a remote site. You will need to log in as administrator to use this function.

Reset to Default (Administrator Function)

Select this command to reset all settings, including the console password, to factory default values. You will need to log in as administrator to use this function.

Import/Export System Config (Administrator Function)

Select this command to reload a configuration that was imported /exported to a text file. You will need to log in as administrator to use this function, and restart the ioLogik I/O system in order for the new configuration to take effect. This command may be used to restore a configuration after loading the factory defaults, or to duplicate a configuration to multiple ioLogik servers.

Export Modbus Map

Select this command to export the Modbus Map of the ioLogik I/O system to a .CSV file. You will need to log in as administrator to use this function. We strongly recommend using this method to record your Modbus Map after you have finished configuring the ioLogik I/O system for your application.

NOTE: The I/O Modbus table is in *.csv format, it can be easily read both in a text editor or the Windows Excel program.

Quick Links



Quick links are provided to search for I/O servers on the network and sort the server list.

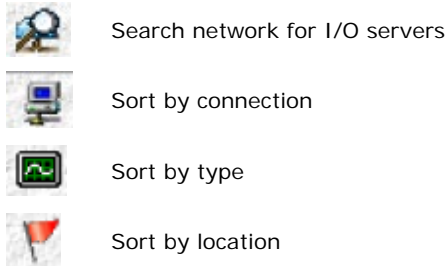

Main Window (General)

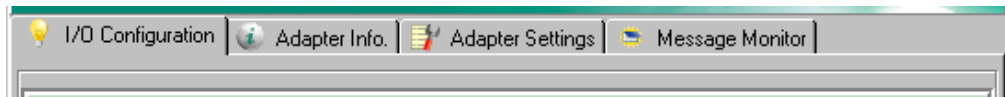

I/O Configuration Tab (General)

If you are not logged in, the I/O Configuration tab shows the picture of the ioLogik E4200 without I/O modules. This is the default tab when you first open Modular ioAdmin.

Adaptor Info Tab

Adaptor information, such as firmware revision, is displayed in the Adaptor Info tab.

Adaptor Settings Tab (General)

Use the Adaptor Settings tab to log in as administrator, which is required to gain access to the ioLogik E4200 configuration options. If an administrator password has not been configured, simply click on Login and leave the Password field blank. More details are provided later in this chapter.

Message Monitor Tab

The Message Monitor tab will display any TCP/UDP I/O messages received from the ioLogik E4200. When you install the ioLogik E4200 for the first time, the Active I/O messaging ruleset will not have been defined yet, so there will be no messages in the Message Monitor Tab. Refer to Chapter 5 for information on how to program the ioLogik E4200's Active I/O messaging system.

Once the active I/O messaging system has been configured and activated, TCP/UDP messages sent from the ioLogik E4200 will be viewable in the Message Monitor tab.

Messages can be displayed in ASCII, UNICODE, or HEX. To display messages in HEX, checkmark **Toggle HEX**. To display messages in UNICODE, checkmark **UNICODE (UCS-2)**.

Administrator Functions



For full access to all configuration options, log in as administrator from the Adaptor Settings tab. This is required whenever you start up ioAdmin or boot up/restart the ioLogik E4200. When you install the ioLogik E4200 for the first time, the password will be blank; in this case, click on **Login** to proceed.

Additional functions will be available after logging in, including the following new tabs:

- Network
- Firmware Update
- Click&Go Logic
- Watchdog
- Active Tags



ATTENTION

You must log in to access administrator functions, including Network, Communication Watchdog Timer, and Firmware Update tabs. If you forget the password, you may hold down the ioLogik’s reset button to clear the password and load factory defaults. **This will result in the loss of all configuration settings and your Click&Go Logic Active I/O messaging program!**

When making configuration changes, you will need to click on **Update** or **Apply** to save the changes. Some changes will require a restart of the ioLogik I/O system in order to take effect, and you will be given the option to restart the computer if necessary.

I/O Configuration Tab (Administrator)

When logged on as administrator, click on an IO Module figure in the **I/O Configuration** tab or click the module name displayed on the Navigation Panel, and then double click on a channel to configure that channel’s settings. A window will open with Modbus Address, I/O status, and Config options (for output modules only) for that module.

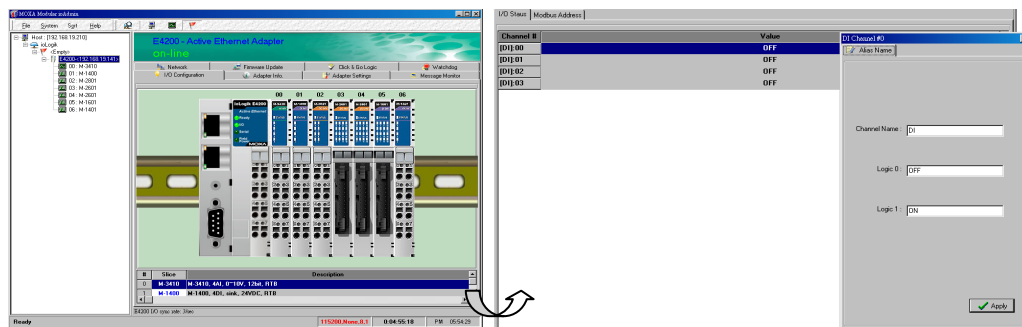

Modbus Address

This sub-tab includes a part for **Address** and another for **Module Information**. The **Address** section shows your channel’s Modbus type: Discrete Input, Coil, or Register. **Module Information** allows you to check the module firmware version.

I/O Status

I/O Status shows the value of the channel and channel name. It also allows you to assign an alias name to the channel, and ON and OFF statuses. Drag the vertical line to enlarge or reduce the column width.

Channel #	Value
[DI]:00	OFF
[DI]:01	OFF
[DI]:02	OFF
[DI]:03	OFF
[DI]:04	OFF
[DI]:05	OFF
[DI]:06	OFF
[DI]:07	OFF

Config (For output modules only)

The list in this tab shows you the module's **Safe Mode Settings** for Power On, Disconnecting, and System Failure.

Channel #	Safe Mode Setting	Fault Value	Power On Setting
[DO]:00	Fault Value	OFF	OFF
[DO]:01	Fault Value	OFF	OFF
[DO]:02	Fault Value	OFF	OFF
[DO]:03	Fault Value	OFF	OFF
[DO]:04	Fault Value	OFF	OFF
[DO]:05	Fault Value	OFF	OFF
[DO]:06	Fault Value	OFF	OFF
[DO]:07	Fault Value	OFF	OFF

Double click to enter the setting. After you double click, the channel setting window will pop up.

You can set safe mode, power on status, test I/O, and alias name.

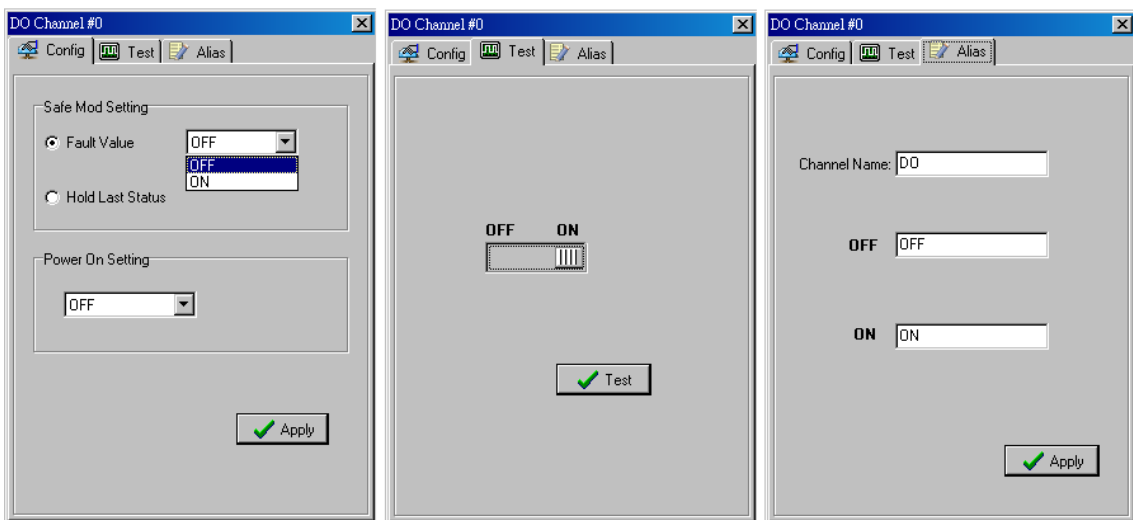

Power on Settings

Use this field to set the initial behavior of the DO/AO channel when the ioLogik system is powered on. For DO channels, you may configure whether or not the DO is set to OFF or ON at power up. For AO channels, you may configure whether or not the AO is set to pre-defined values at power up.

Safe Status Settings

Use this field to specify how the I/O channel behaves when the network connection is lost. When the network connection is lost for the amount of time specified in the Host Connection Watchdog, the ioLogik E4200 enters Safe Status, and each I/O channel's Safe Status settings will go into effect.



ATTENTION

Two situations will prompt the Active Ethernet modular I/O to enter Safe Status. One is Host Connection Lost and the other is Internal I/O Bus Failed. When the ioLogik E4200 is in safe mode, you cannot start Click&Go logic or change the module configuration.

1. Host Connection Lost: The "I/O" LED shows a steady red.

The Host Connection Watchdog is disabled by default. If the Host Connection Watchdog is disabled, the ioLogik I/O system will never enter Safe Status and the Safe Status settings will have no effect.

2. Internal I/O Bus Failed: The "I/O" LED flashes red. Check your I/O system installation.

Test I/O

Modular ioAdmin can be used to test a DO or AO channel.

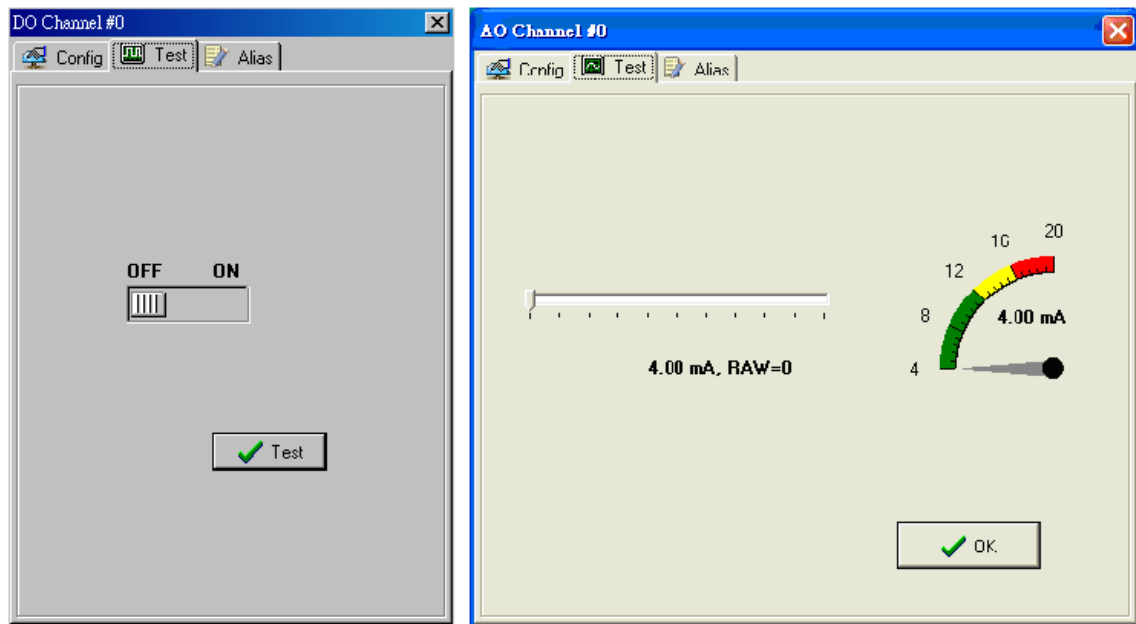

Adaptor Settings Tab (Administrator)

There are five parts to this TAB: Password, Management Settings, Time settings, System Log, and Modbus Address Mode. You can set up a password, adaptor name, location, date, time zone, and time server in the Adaptor Settings tab. Modular ioAdmin supports long adaptor names and a location description of up to 58 characters.

If you will be using ioEventLog to receive system status reports, such as for warm or cold starts, indicate the IP address and port number for the PC that will be running ioEventLog in the **System Log** field. The default port number is 4040. For additional information, refer to the ioEventLog section later in this chapter.

Modular ioAdmin also provides different Modbus address modes, including **Fixed** mode (the default) and **Dynamic** mode. For detailed information, refer to the appendix.

The screenshot shows the Utilities web interface with the following sections:

- Management Settings:** Includes fields for Change Password (8 char max.), Reconfirm Password, Adapter Name, and Adapter Location, each with an Update button.
- Time Settings:** Includes Local, Date (2000/1/1), Time (0:1:20), Time Zone (GMT), and Time Server, with an Update button.
- System Log:** Includes Log Server Address, Port (4040), and an Update button.
- Modbus Addressing Mode:** Includes radio buttons for Fixed Mode (selected) and Dynamic Mode, with an Update button.
- A Refresh button is located at the bottom right.

Network Tab (Administrator)

Use the **Network** tab to configure IP settings, Modbus/TCP Alive Check Timeout settings, DNS settings, SNMP settings, and Web Access settings for the ioLogik E4200.

The screenshot shows the Network configuration page with the following sections:

- IP Settings:** Shows LAN0 and LAN1 configurations. Both are set to Static IP. LAN0 IP is 192.168.127.254 and LAN1 IP is 192.168.126.254. Subnet Mask for both is 255.255.255.0. MAC addresses are 00-90-E8-00-42-30 for LAN0 and 00-90-E8-00-42-31 for LAN1. Default Gateway is 192.168.126.1, with LAN1 selected as the active interface.
- Modbus/TCP Alive Check Timeout:** Includes a checkbox for 'Enable Modbus/TCP idle connection' and a timeout interval of 60 seconds.
- DNS Settings:** Includes fields for DNS #1 and DNS #2, both set to 255.255.255.255.
- SNMP Settings:** Includes a checkbox for 'Enable SNMP', Read Community (public), Write Community (private), Contact, and Location.
- Web Access Settings:** Includes a checkbox for 'Enable'.

IP Settings: You can set up a static or dynamic IP address for the ioLogik E4200's two LAN ports, and also configure the subnet mask and gateway address.

In the following example, we configure the dual Ethernet ports to connect to two independent networks. LAN1 connects through router R1 to network 192.168.1.0, and LAN0 connects through router R2 to network 192.168.2.0. Router R1 acts as the default gateway.

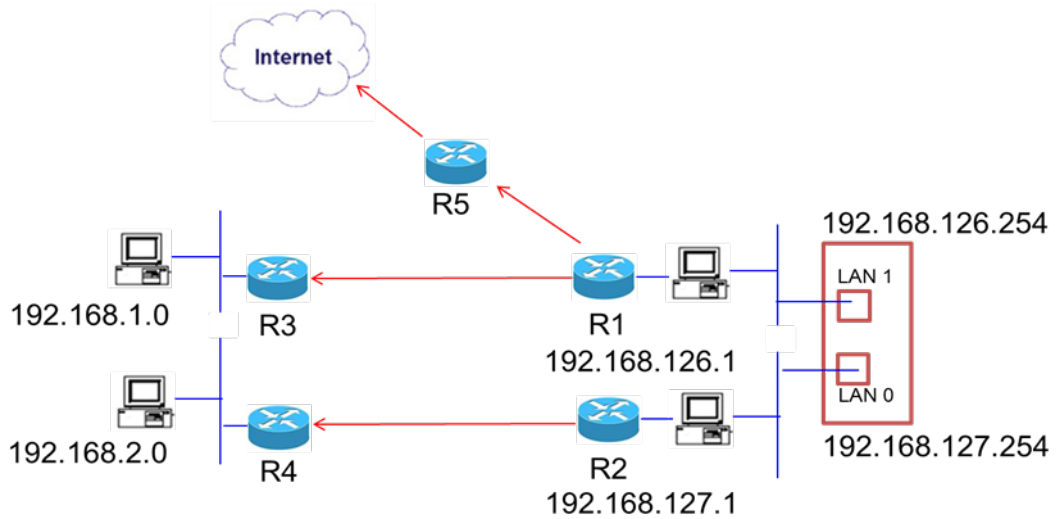

- 1. Configure the IP address and subnet mask.

IP Settings

LAN0 IP Configuration : Static	LAN1 IP Configuration : Static
IP Address : 192.168.127.254	IP Address : 192.168.126.254
Subnet Mask : 255.255.255.0	Subnet Mask : 255.255.255.0
MAC : 00-90-E8-00-42-30	MAC : 00-90-E8-00-42-31
Default Gateway Gateway : 0.0.0.0	
<input checked="" type="radio"/> LAN0 <input type="radio"/> LAN1	
Accessible IP	Route Table <input checked="" type="button" value="Update"/>

- 2. Click **Route Table** to set up the routing table.

IP Settings

LAN0 IP Configuration : Static	LAN1 IP Configuration : Static
IP Address : 192.168.127.254	IP Address : 192.168.126.254
Subnet Mask : 255.255.255.0	Subnet Mask : 255.255.255.0
MAC : 00-90-E8-00-42-30	MAC : 00-90-E8-00-42-31
Default Gateway Gateway : 0.0.0.0	
<input checked="" type="radio"/> LAN0 <input type="radio"/> LAN1	
Accessible IP	Route Table <input checked="" type="button" value="Update"/>

- Fill in the routing table information and then click **Add**.

Route Table Configuration

Add/Delete Route Entry

Destination	Netmask	Gateway	Interface	Metric
192.168.1.0	255.255.255.0	192.168.126.1	LAN-1	1

Network Route Table

Destination	Netmask	Gateway	Interface	Metric
192.168.1.0	255.255.255.0	192.168.126.1	LAN-1	1
192.168.2.0	255.255.255.0	192.168.127.1	LAN-0	1
192.168.126.0	255.255.255.0	192.168.126.254	LAN-1	1
192.168.127.0	255.255.255.0	192.168.127.254	LAN-0	1

- Configure the Default Gateway, and then use the radio buttons to select LAN0 or LAN1 as the default gateway.

IP Settings

<p>LAN0</p> <p>IP Configuration : <input type="text" value="Static"/></p> <p>IP Address : <input type="text" value="192.168.127.254"/></p> <p>Subnet Mask : <input type="text" value="255.255.255.0"/></p> <p>MAC : 00-90-E8-00-42-30</p>	<p>LAN1</p> <p>IP Configuration : <input type="text" value="Static"/></p> <p>IP Address : <input type="text" value="192.168.126.254"/></p> <p>Subnet Mask : <input type="text" value="255.255.255.0"/></p> <p>MAC : 00-90-E8-00-42-31</p>
<p>Default Gateway</p> <p>Gateway : <input type="text" value="192.168.126.1"/> <input type="radio"/> LAN0 <input checked="" type="radio"/> LAN1</p>	
<p><input type="button" value="Accessible IP"/> <input type="button" value="Route Table"/> <input type="button" value="Update"/></p>	

- Click **Update** to update the configuration, and then restart the ioLogik E4200 to activate the new network settings.

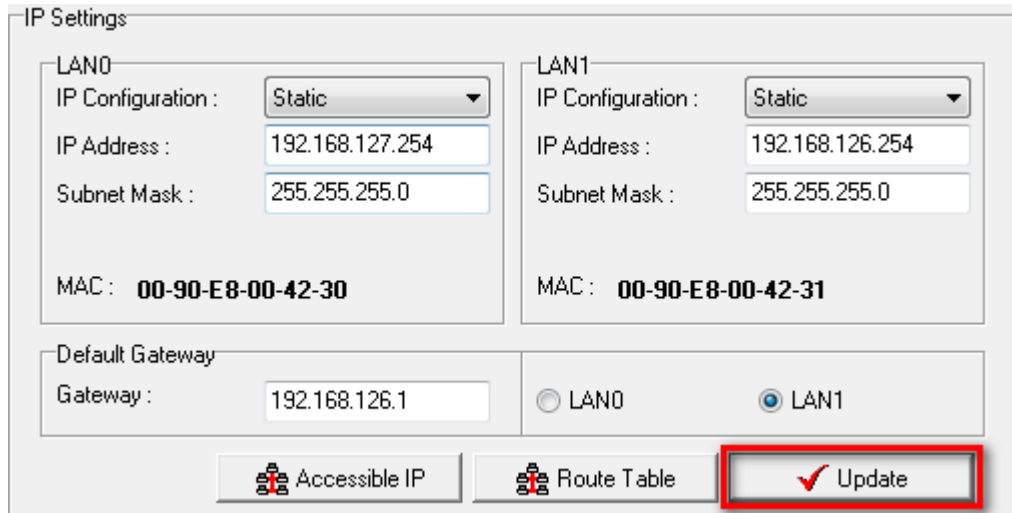

- Click **Route Table** again to verify that the setup was successful. The New Route Table will appear as follows if the configuration was done correctly.

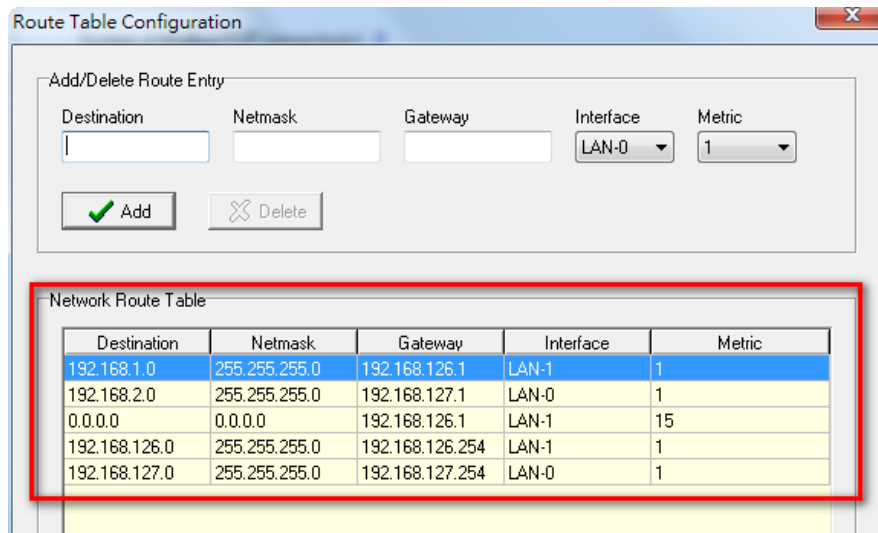

Destination	Netmask	Gateway	Interface	Metric
192.168.1.0	255.255.255.0	192.168.126.1	LAN-1	1
192.168.2.0	255.255.255.0	192.168.127.1	LAN-0	1
0.0.0.0	0.0.0.0	192.168.126.1	LAN-1	15
192.168.126.0	255.255.255.0	192.168.126.254	LAN-1	1
192.168.127.0	255.255.255.0	192.168.127.254	LAN-0	1

NOTE You should avoid setting up two IPs on the same physical network and subnet, since doing so could cause unpredictable results.

The **Accessible IP** screen can be used to control network access to the ioLogik E4200 and attached sensors. Network requests that originate from sources that are not listed in the accessible IP list will be unable to use Modbus/TCP or Modular ioAdmin to access the ioLogik E4200.

Note: You also can create your own Route Table by clicking the “Route Table” button.

Modbus/TCP Alive Check Timeout Settings: The Modbus/TCP Alive Check Timeout is designed to avoid TCP connection failure. When the host is down, the ioLogik E4200 will continue to wait for a response from the host. This will cause the TCP port to be indefinitely occupied by the host. When the Modbus/TCP idle connection timeout interval is enabled, the ioLogik E4200 will close the TCP connection automatically if there is no TCP activity for the specified time. Please note that Modbus/TCP connections will be blocked when setting up Accessible IP.

DNS Settings: Use this field to specify the IP addresses for up to 2 DNS servers. These two DNS servers may be used to automatically find available e-mail addresses when configuring for Active Ethernet I/O e-mail messaging.

SNMP Settings: The ioLogik E4200 provides SNMPv2 (Simple Network Management Protocol) to monitor the network and I/O devices with SNMP Network Management software. It is useful in building automation and telecom applications. Use these fields to enable SNMP and set the read and write community strings.

Web Access Settings: This field enables and disables the ioLogik E4200's web console. The web console allows the configuration of many settings using a web browser that is directed to the I/O device's IP address. If the web console is not enabled in this field, you will not be able to access the web console.

Firmware Update Tab (Administrator)

The ioLogik E4200 supports remote firmware updates through the **Firmware Update** tab. Enter the path to the firmware file or click on the icon to browse for the file. Click **Update** to update the firmware. The wizard will lead you through the process until the I/O device is restarted.

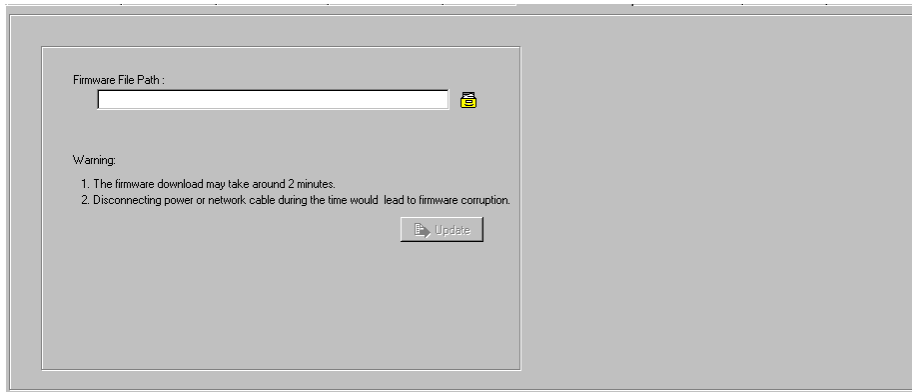

Firmware File Path: 

Warning:

1. The firmware download may take around 2 minutes.
2. Disconnecting power or network cable during the time would lead to firmware corruption.





ATTENTION

Do not interrupt the firmware update process! An interruption in the process may result in your device becoming unrecoverable. After the firmware is updated, the ioLogik will restart and you will need to log in again to access administrator functions.

Watchdog Tab (Administrator)

Use the **Watchdog** tab to configure the Host Connection Watchdog, which is used with the Safe Status settings to define each I/O channel's response to a lost network connection. When the ioLogik E4200 loses its network connection for the amount of time specified in the timeout, the Host Connection Watchdog will switch the ioLogik E4200 to Safe Status and the I/O channels will reset to their Safe Status settings. By default, the Watchdog is disabled. To enable the Watchdog, make sure **Enable Host Connection Watchdog** is checked, set the Timeout value, and then click the **Update** button.

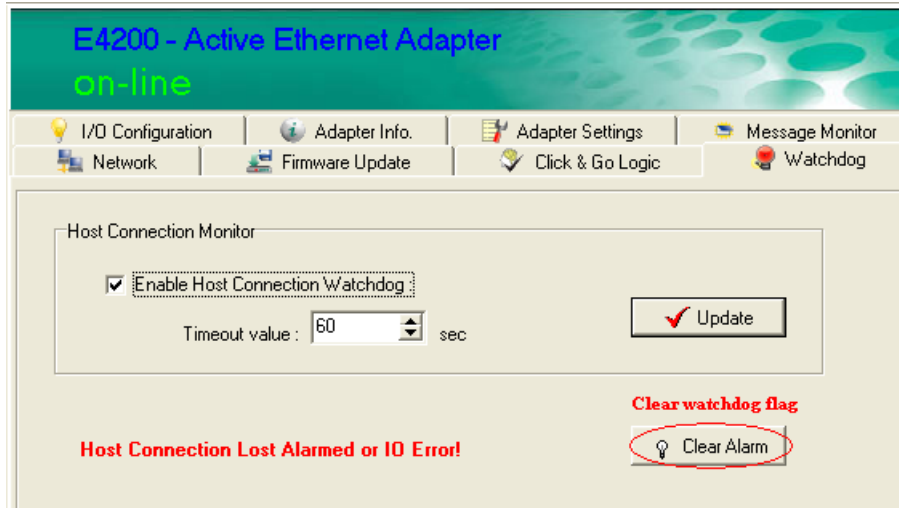

After the Watchdog is enabled, the ioLogik E4200 will enter safe status if the network connection is lost. Once the connection has been restored, you will need to return to the Watchdog Tab in order to exit safe status. You will see a "Host Connection Lost" message indicating that the I/O device is in safe status. Click **Clear Alarm** to exit safe status and return to normal operation.

Active Tags (Administrator)

Click the **Active Tags** tab to configure the I/O channels to report their status to a Moxa proprietary Active OPC Server package. The Active Tags and the Moxa Active OPC Server package provide I/O status reports by event via TCP packets. This allows the ioLogik to provide the OPC-SCADA architecture with better I/O monitoring and control. Specify the IP address of the Active OPC Server, select the I/O channel that needs to be updated, and then click the "Create Tag" button. The tags will be created automatically. In other words, users only need to launch the Active OPC Server program, and the I/O channels selected by the user will be "pushed" from the ioLogik to Active OPC Server.

1. Download Active OPC Server Lite from Moxa's website and install it.
2. Log in to the Modular ioAdmin utility and go to the Active Tags tab.
3. Specify the Active OPC Server IP Address by clicking on the IP button. After clicking OK, Modular ioAdmin will ask you to restart the ioLogik E4200.
4. Click the Active Tags tab to specify which I/O modules and channels need to be updated.
5. After clicking the Active Tags tab, we recommend specifying the Heartbeat Interval so that the Active OPC Server is able to detect when the ioLogik E4200 is disconnected.
6. Next, click on the Create Tags button.
7. Launch the Active OPC Server program from the PC; all of the tags will be generated automatically.

Slot#	Module	Channel Selection	Percent(%)
0	M-4211		
1	M-4211		
2	M-3402		1
3	M-3414		1
4	M-3403		1
5	M-2404		
6	M-4210		

ALL AI Channels
 CH-00 CH-01 CH-02 CH-03

On change : %

Heartbeat Interval : sec (1~65535)

All slot Channels enabled (default range: 1%)



ATTENTION

When the ioLogik E4200 is in safe mode, you cannot start Click&Go logic and cannot change the module configuration. The Host Connection Watchdog is disabled by default. If the Host Connection Watchdog is disabled, the ioLogik I/O system will never enter Safe Status and the Safe Status settings will have no effect. During Host Connection Lost, the "I/O" LED will show a steady red to indicate that it is in Safe Mode. After clearing the alarm, you must restart the system. If you see the I/O LED indicator flashing Red, power off the system and power it on again to return to normal operation.

Click&Go Logic Tab (Administrator)

The **Click&Go** logic tab is used by the administrator to set up the ioLogik E4200's Active I/O messaging logic. Instead of the I/O device reacting passively to repeated polling requests from a host for I/O data, the ioLogik E4200 can actively send I/O information to the host when an I/O channel satisfies conditions that you specify. Click&Go logic was developed by Moxa to provide a powerful and easy-to-use tool for defining the conditions under which I/O information will be sent over the network. Refer to Chapter 5 for detailed information.

Changes made on the Click&Go logic tab are not effective until you download the logic and the ioLogik E4200 is restarted, as with changes made to other tabs.



ATTENTION

Note that when Click&Go logic is being used, the range and units of I/O channels being used in Click&Go logic cannot be modified.

Using TFTP to Import/Export a Configuration

TFTP (Trivial File Transfer Protocol) was defined in 1980 to provide basic FTP functionality in a very simple protocol. Due to TFTP's simplicity, it can be implemented using a very small amount of memory, an important consideration when it was first developed. The ioLogik E4200 I/O supports the use of TFTP to import or export configuration files.

The following example uses Windows TFTP and an ioLogik E4200 with an IP address of 192.168.127.254:

1. Enter "TFTP 192.168.127.254 GET ik4200.txt" to get the ioLogik's configuration file.
2. Enter "TFTP 192.168.127.254 PUT ik4200.txt" to load a configuration file onto the ioLogik

```
Transfers files to and from a remote computer running the TFTP service.

TFTP [-i] host [GET | PUT] source [destination]

-i          Specifies binary image transfer mode (also called
           octet). In binary image mode the file is moved
           literally, byte by byte. Use this mode when
           transferring binary files.

host        Specifies the local or remote host.

GET         Transfers the file destination on the remote host to
           the file source on the local host.

PUT         Transfers the file source on the local host to
           the file destination on the remote host.

source      Specifies the file to transfer.

destination Specifies where to transfer the file.
```

You must use "ik4200.txt" as the destination filename when copying a configuration file to the ioLogik E4200 unit. Otherwise, you will receive the error message shown below:

```
Error on server : ioServer - Fail to write file !!cess Protocol
pcmail-srv      158/tcp          #PCMail Server
snmp             161/udp          #SNMP
snmptrap        162/udp          snmp-trap      #SNMP trap
print-srv       170/tcp          #Network PostScript
bgp             179/tcp          #Border Gateway Protocol
irc             194/tcp          #Internet Relay Chat Protocol
|
ipx             213/udp          #IPX over IP
ldap            389/tcp          #Lightweight Directory Acces
s Protocol
https           443/tcp          MCom
https           443/udp          MCo
https           443/tcp          MCom
https           443/udp          MCo? █
```

You can use TFTP in a batch file to transfer configuration files for different units. For example, you might have two configuration files that need to be copied to two different I/O devices: **ik4200_1.txt** for 192.168.127.253, and **ik4200_2.txt** for 192.168.127.254. A batch file could be written as follows:

```
tftp 192.168.127.253 put ik4200_1.txt ik4200.txt
```

```
tftp 192.168.127.254 put ik4200_2.txt ik4200.txt
```



ATTENTION

You can also run TFTP client software, open the configuration file, and enter the remote I/O's IP. Note that both ASCII and Octet mode are supported. When the download process is complete, the I/O will reboot.

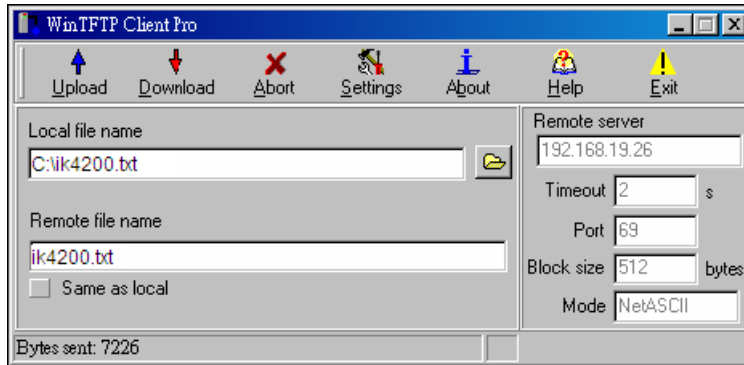

Trade Mark Notice: WinTFTP Client Pro is a trademark of WinTFTP. All rights reserved.

Using ioEventLog

Installing ioEventLog

ioEventLog is a Windows utility that can be used anywhere on the network to monitor the ioLogik E4200.

ioEventLog can be downloaded from Moxa's website.

1. Installing ioEventLog from website:

- a. First click on the following link to access the website's search utility:
<http://www.moxa.com/support/search.aspx?type=soft>
- b. When the web page opens, enter the model name of your product in the search box.
- c. Click the model name and navigate to the product page, and then click on ioEventLog, located in the box titled Software.
- d. Download and then unzip the file. Run **SETUP.EXE** from that location.
 The installation program will guide you through the installation process and install the software.

2. Open ioEventLog: After installation is finished, run ioEventLog from **Start → Program Files → MOXA → IO Server → Utility → ioEventLog**.



3. The main window will appear as shown below.

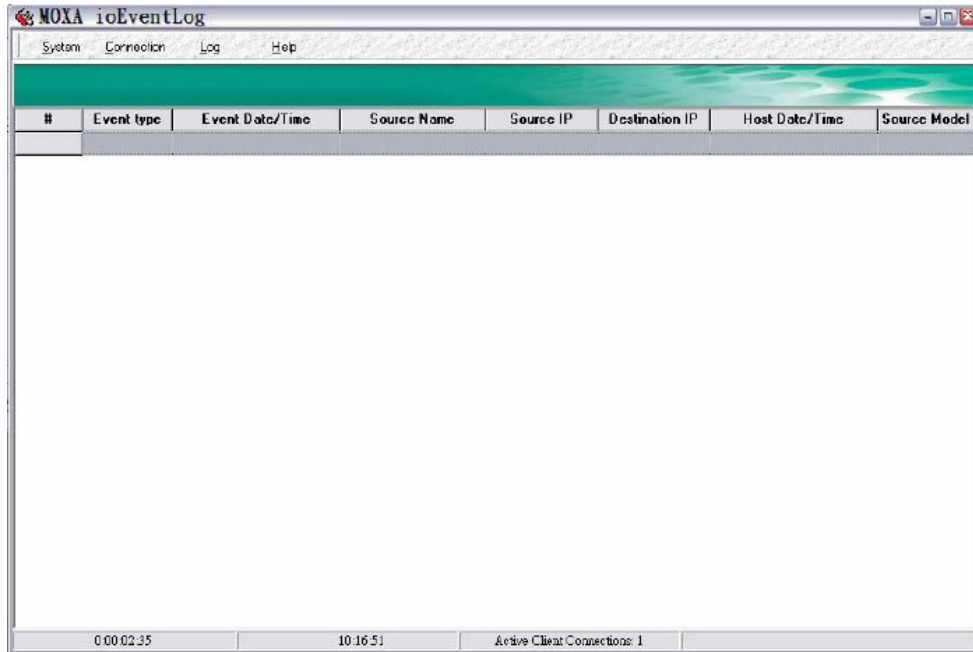

Basic Functions

ioEventLog is installed along with ioAdmin. It is designed to help you keep a record of ioLogik status events over the network. The log is stored on the Windows PC. You will need to set up your ioLogik to send status events to the PC's IP address. The following events are monitored:

- cold start
- warm start

For each event, the following information is provided. The log can be sorted by any of seven fields:

#	Event type	Event Date/Time	Source Name	Source IP	Destination IP	Host Date/Time	Source Model
---	------------	-----------------	-------------	-----------	----------------	----------------	--------------

Main Menu



System

Select **Settings** from the System menu to configure ioEventLog.

The Alarm Listen Port is the TCP port number that will be monitored for status events. You can modify this setting as necessary to receive signals through a firewall. It must match the settings for the ioLogik that is being monitored. The Log Directory is where the log files will be stored. The default directory is C:\Program Files\Moxa\ioEventLog\log. A separate log file is created for each day, with file names assigned automatically.

You can also select the color of each event type in the log.

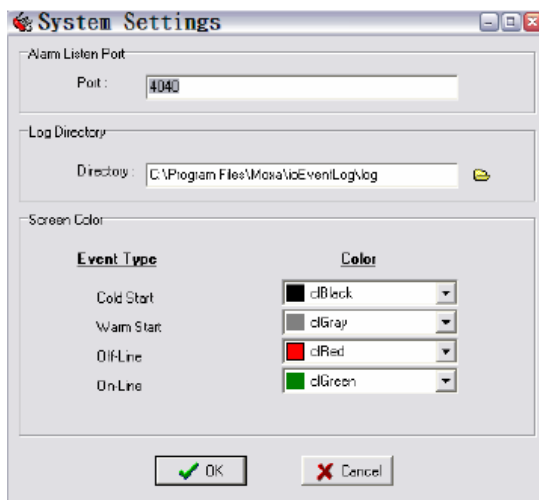

Connection

Checking Connected Devices

You can see which I/O devices are already connected to ioEventLog by selecting Connected Device List from the Connection menu.



Log

Opening Log Files

You can view previously saved logs by selecting **Open** from the Log menu. You will be prompted for the data that you wish to view.

The logs for the selected day will be displayed.

Clearing the Log

If you wish to clear the log, you can select Clear from the Log menu. This will clear all events for the current day. The cleared events will not be saved in that day's logs. After the logs are cleared, new events will be displayed and recorded as usual.

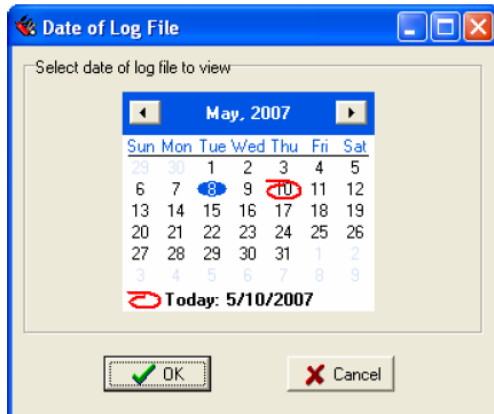

Help

Check the information of ioEventLog here, including version.

Using the Built-in Web Console

In this chapter, we introduce the built-in web console, used to monitor the ioLogik Active Ethernet modular I/O system.

The following topics are covered in this chapter:

❑ **Overview for the ioLogik E4200**

❑ **Entering the Web Console**

❑ **Overview**

❑ **Basic Settings**

❑ **Network Settings**

- Adaptor Settings
- Ethernet Configuration
- Route Table

❑ **I/O Module**

❑ **System Management**

- Accessible IP Settings
- SNMP Agent
- Network Connection
- Firmware Update
- Import System Config
- Export System Config

❑ **Change password**

❑ **Load Factory Default**

❑ **Save/Restart**

Overview for the ioLogik E4200

The ioLogik Active Ethernet modular I/O web console is a browser-based configuration utility built in to the ioLogik E4200. When the ioLogik Active Ethernet modular I/O is connected to your network, you may enter the I/O's IP address in your web browser to access the web console. Note that although most configuration options are available in the web console, some settings are only available through Modular ioAdmin. Furthermore, the web console can be disabled under Web Access Settings in Modular ioAdmin. If you are unable to access the web console, check the Web Access Settings in Modular ioAdmin.

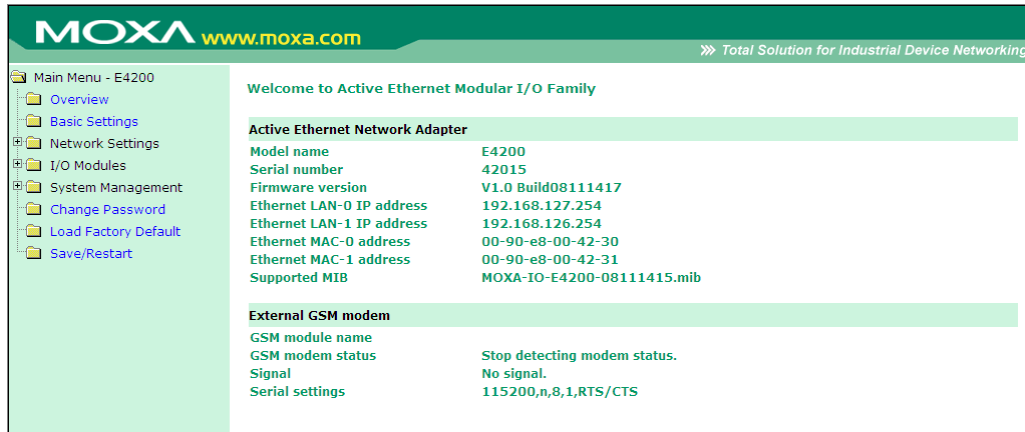

The left navigation panel contains an expandable tree menu for navigating among the various settings and categories. When you click on a menu item in the navigation panel, the main window will display the corresponding options for that item. Configuration changes can then be made in the main window. For example, if you click on **Basic Settings** in the navigation panel, the main window will show a page of basic settings that you can configure.

You must click on the **Submit** button after making configuration changes. The **Submit** button will be located at the bottom of every page that has configurable settings. If you navigate to another page without clicking the **Submit** button, your changes will not be retained. **Submitted changes will not take effect until they are saved and the ioLogik E4200 is restarted!**

You may save and restart the ioLogik in one step by clicking on the **Save/Restart** button after you submit a change. If you need to make several changes before restarting, you may save your changes without restarting by selecting **Save** in the navigation panel. If you restart the ioLogik E4200 without saving your configuration, the ioLogik E4200 will discard all submitted changes.

Entering the Web Console

Modular ioAdmin utility is the main configuration interface for the ioLogik Active Ethernet modular I/O. However, for the ioLogik E4200 Active Ethernet network adaptor's web console, information for basic system status is available.

Enter the IP address of the Active Ethernet Modular I/O in Internet Explorer.

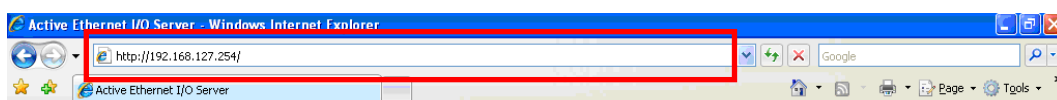

The default IPs are listed below:

LAN Port	Default IP Address	Default Netmask	Default Gateway
LAN 0	192.168.127.254	255.255.255.0	None
LAN 1	192.168.126.254	255.255.255.0	None

Overview

When you log in to the web console with the ioLogik E4200 IP address, you will see the welcome page. The page includes basic information about the ioLogik E4200, such as network adaptor model name, serial number, firmware version, and IP and MAC addresses. It also shows you the information of the GSM modem and status.



ATTENTION

The web console only supports Moxa OnCell 2111 and 2151 GPRS modem. In addition, auto detection is only available for the GSM modem when using SMS in the Click&Go ruleset. The default serial baudrate is 115200 bps, and parameters are N, 8, 1.

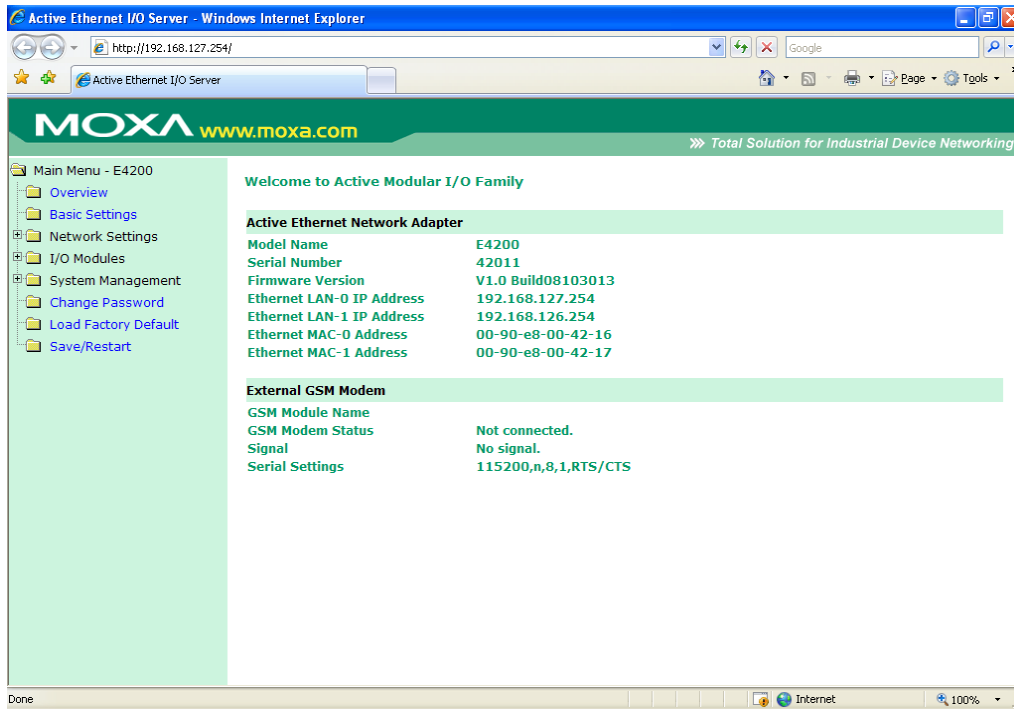

Basic Settings

On the Basic Settings page, you may set the ioLogik E4200's system time or provide the IP address of a time server for time synchronization.

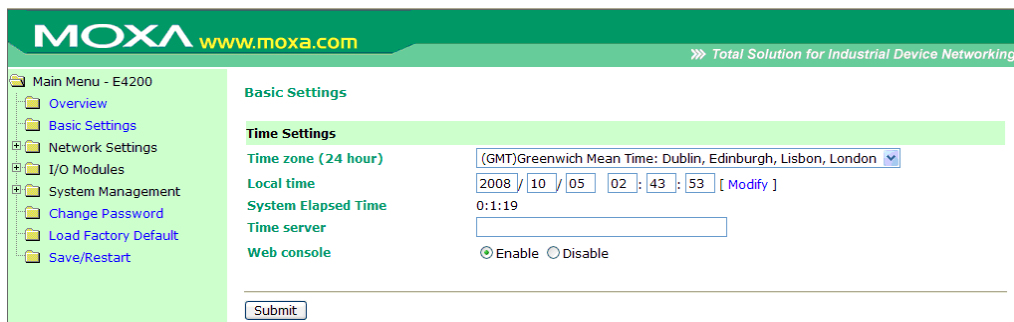

Network Settings

Adaptor Settings

On the Adaptor Settings page, you may assign an adaptor name and location to assist you in differentiating between different network adaptors. You may also enable the Host Communication Watchdog and define the timeout value.

The screenshot shows the Moxa web console interface. The top header displays the Moxa logo and website URL. A navigation menu on the left lists various settings categories. The main content area is titled 'Adaptor Settings' and contains the following fields:

I/O Adapter Settings	
Adapter name	<input type="text"/>
Adapter location	<input type="text"/>
DNS server 1	<input type="text" value="255.255.255.255"/>
DNS server 2	<input type="text" value="255.255.255.255"/>
<input type="checkbox"/> Enable communication watchdog	<input type="text" value="0"/> sec

A 'Submit' button is located at the bottom of the form.

The Host Connection Watchdog activates Safe Status when the ioLogik E4200 loses its network connection for the specified amount of time. By default, the Watchdog is disabled. When the Watchdog is enabled and a timeout occurs, the ioLogik E4200 will enter Safe Status. You may use Modular ioAdmin to configure how each output channel responds under that channel's Safe Status settings. To enable the Watchdog, check off **Enable connection watchdog**, set the timeout value, and restart the I/O system. With Watchdog enabled, the ioLogik E4200 will enter Safe Status after a disruption in communication that exceeds the specified time.

Ethernet Configuration

On the Ethernet Configuration page, you may set up a static or dynamic IP address for the ioLogik I/O system, as well as the subnet mask and gateway address.

The screenshot shows the Moxa web console interface. The top header displays the Moxa logo and website URL. A navigation menu on the left lists various settings categories. The main content area is titled 'Ethernet Configurations' and contains the following sections:

LAN-0 Ethernet Parameters	
IP Configuration	Static
IP Address	<input type="text" value="192.168.127.254"/>
Subnet Mask	<input type="text" value="255.255.255.0"/>
Gateway	<input type="text" value="0.0.0.0"/>

LAN-1 Ethernet Parameters	
IP Configuration	Static
IP Address	<input type="text" value="192.168.126.254"/>
Subnet Mask	<input type="text" value="255.255.255.0"/>
Gateway	<input type="text" value="0.0.0.0"/>

A 'Submit' button is located at the bottom of the form.

Route Table

The ioLogik E4200 has two independent Ethernet ports (2 MACs and 2 IPs). Appropriate routing is needed to make sure the network works properly. You can define your network route table through the network administrator.

MOXA www.moxa.com » Total Solution for Industrial Device Networking

Main Menu - E4200

- Overview
- Basic Settings
- Network Settings
 - General Settings
 - Ethernet Configurations
 - Route Table
- I/O Modules
- System Management
 - Accessible IP Settings
 - SNMP Agent
 - Network Connection
 - Firmware Update
 - Import System Config
 - Export System Config
 - Change Password
 - Load Factory Default
 - Save/Restart

Route Table Configuration

Add/Delete a route entry

Destination	Netmask	Gateway	Interface	Metric
<input type="text"/>	<input type="text"/>	<input type="text"/>	LAN-0	14

Network Route Table

Destination	Netmask	Gateway	Interface	Metric
192.168.126.0	255.255.255.0	192.168.126.254	LAN-1	1
192.168.127.0	255.255.255.0	192.168.127.254	LAN-0	1

I/O Module

On this page, you can find the modules you installed in this I/O system. They are displayed in sequence according to the module Name you installed. With different modules, you are allowed to configure various channels. For details, see Chapter 3.

The following example illustrates configuring an Analog Output channel:

MOXA www.moxa.com » Total Solution for Industrial Device Networking

Main Menu - E4200

- Overview
- Basic Settings
- Network Settings
- I/O Modules
 - 00 : M-2250
 - 01 : M-4211
 - Configuration
 - I/O Status
 - 02 : M-4202
 - 03 : M-1450
 - 04 : M-2402
 - 05 : M-2401
 - 06 : M-1401
 - 07 : M-3402
 - 08 : M-3412
 - 09 : M-2800
 - 10 : M-2601

M-4211 AO Module, 2 channels, -10~10V, 12bit

Channel #	Power On Setting	Safe Mode Setting
[AO-00]	0.00V	0.00V
[AO-01]		

[NOTE]: * channel is locked
[NOTE]: ** system is in safe mode

http://192.168.127.254 - AI Channel Settings - Microsoft In...

AO Channel #00 Settings

PowerOn Value(HEX)

Safe Action
Fault Value

Fault Value(HEX)

The following example illustrates configuring a Digital Output channel:

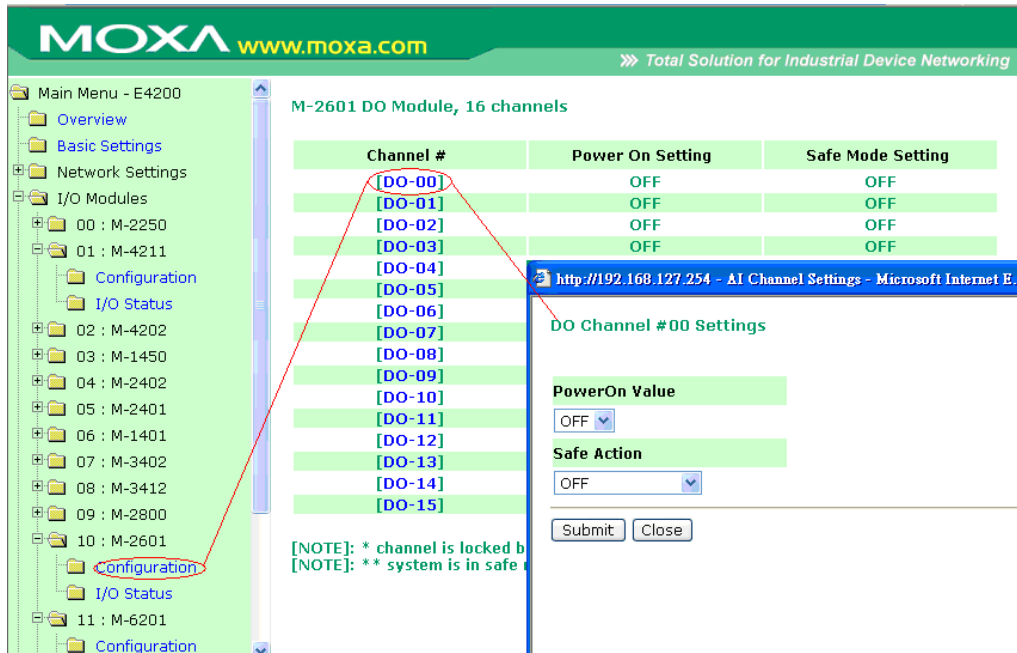

You may use the **PowerOn Value** field to specify the channel's settings when the ioLogik system is powered on, and the **Safe Status Setting** field to specify channel's settings when the ioLogik system enters Safe Status. Note that Safe Status is controlled by the Host Connection Watchdog, which is disabled by default. If the Host Connection Watchdog is disabled, the ioLogik system will never enter Safe Status and your Safe Status settings will have no effect.

System Management

Accessible IP Settings

You may add a specific address or range of addresses (up to 10) using a combination of IP address and netmask, as follows:

To allow access to a specific IP address

Enter the IP address in the corresponding field; enter **255.255.255.255** for the netmask.

To allow access to hosts on a specific subnet

For both the IP address and netmask, use **0** for the last digit (e.g., **192.168.1.0** and **255.255.255.0**).

To allow unrestricted access

Deselect the **Enable the accessible IP list** option.

Refer to the following table for additional configuration examples.

Allowed Hosts	IP Address/Netmask
Any host	Disable
192.168.1.120	192.168.1.120 / 255.255.255.255
192.168.1.1 to 192.168.1.254	192.168.1.0 / 255.255.255.0
192.168.0.1 to 192.168.255.254	192.168.0.0 / 255.255.0.0
192.168.1.1 to 192.168.1.126	192.168.1.0 / 255.255.255.128
192.168.1.129 to 192.168.1.254	192.168.1.128 / 255.255.255.128

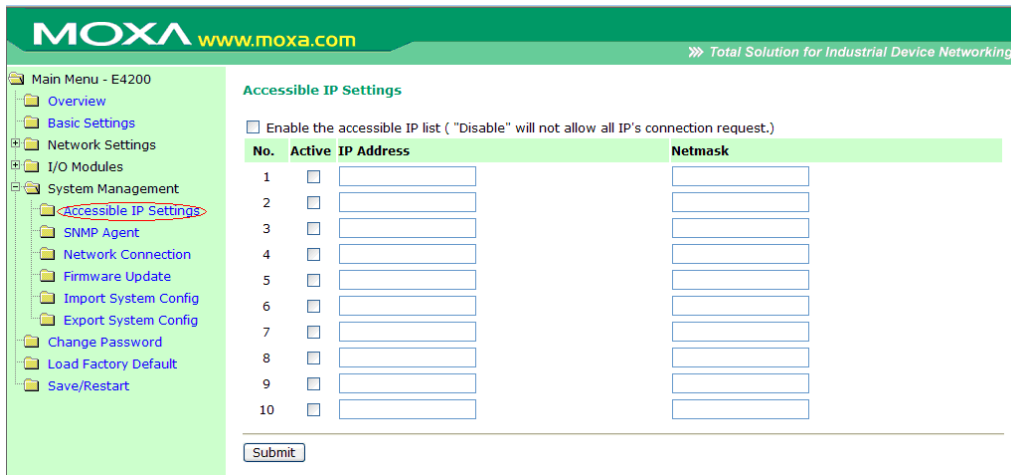

SNMP Agent

On the SNMP Agent page, you can enable SNMP and set the read and write community strings. The ioLogik E4200 supports SNMPv2 (Simple Network Management Protocol) to allow monitoring of network and I/O devices with SNMP Network Management software. It is useful in building automation and telecom applications.



Network Connection

On the Network Connection page, you can view the TCP connections from other hosts, which can assist you with the management of your devices.

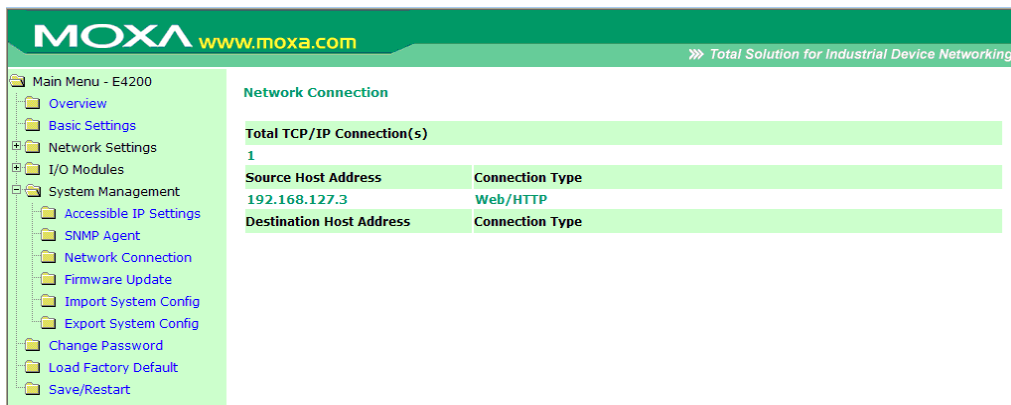

Firmware Update

On the Firmware Update page, you can load new or updated firmware to the ioLogik.

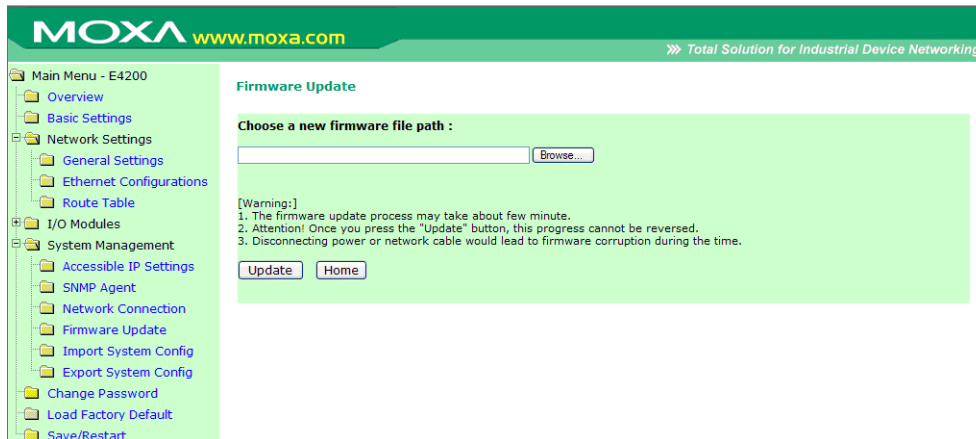

Import System Config

On the Import System Config page, you can import a configuration to the ioLogik system. The configuration file can be generated by ioAdmin or through the web console. This function can be used to duplicate settings between ioLogik systems. You will be prompted for the location of the configuration file (i.e., "ik4200.txt") and if you wish to overwrite network settings.

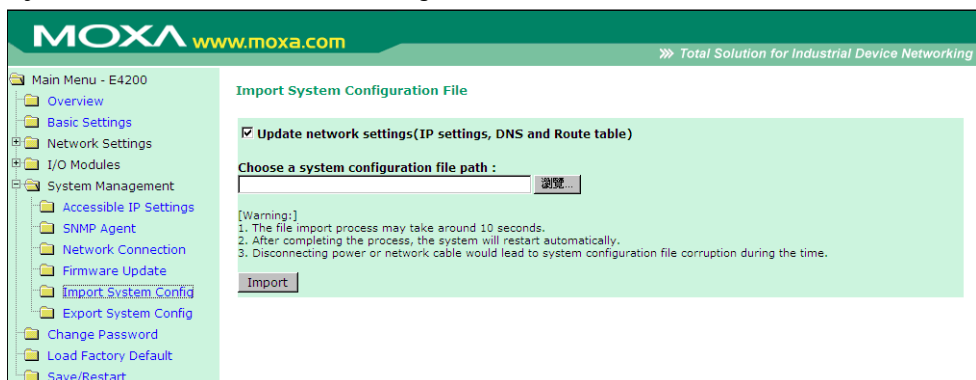

Export System Config

On the Export System Config page, you can click the file name "ik4200.txt" to save the ioLogik's configuration to a file for backup or for importing into another ioLogik system. Note that the system will specify the filename as **ik4200.txt**.

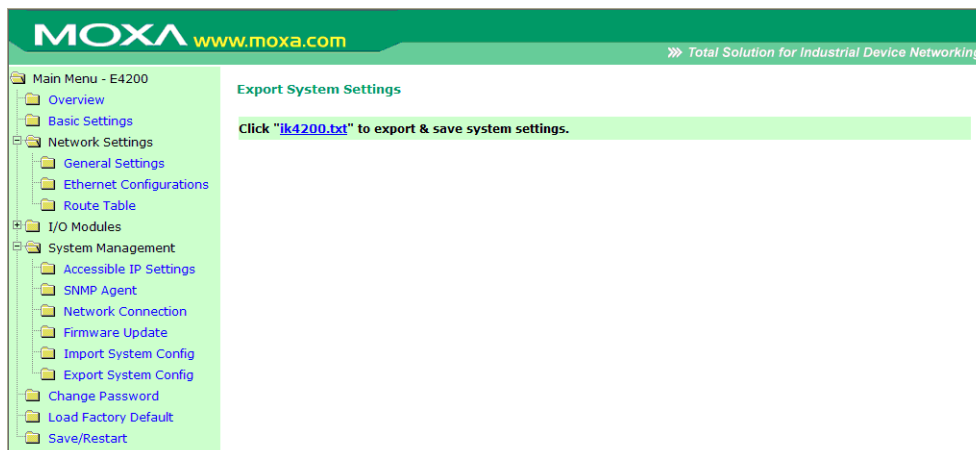

Change password

For all changes to the ioLogik E4200's password protection settings, you will first need to enter the existing password. Leave this blank if you are setting up password protection for the first time. To set up a new password or change the existing password, enter your desired password under both New password and Confirm password. To remove password protection, leave the New password and Confirm password fields blank.

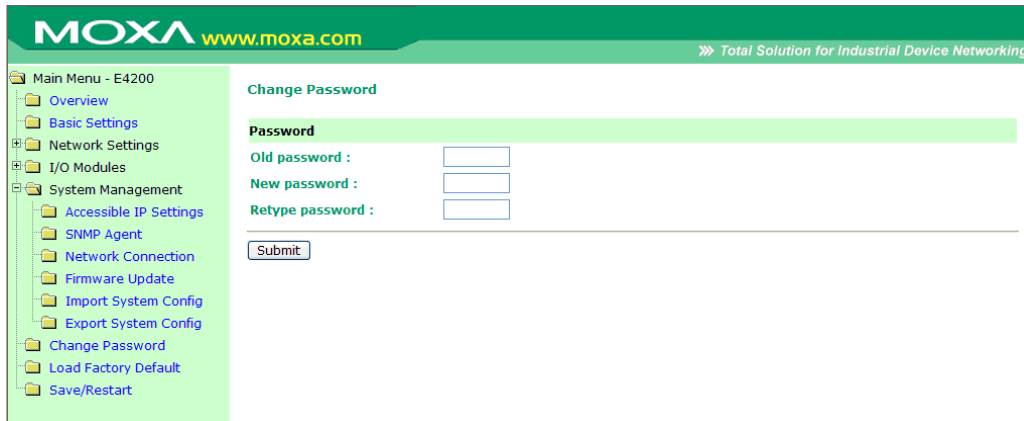

The screenshot shows the Moxa web console interface. The top header is green with the Moxa logo and the text 'www.moxa.com' and 'Total Solution for Industrial Device Networking'. On the left, there is a navigation menu with 'Main Menu - E4200' expanded to show 'System Management' and 'Change Password' selected. The main content area is titled 'Change Password' and contains a 'Password' section with three input fields: 'Old password', 'New password', and 'Retype password'. A 'Submit' button is located below the fields.



ATTENTION

If you forget the password, the ONLY way to configure the ioLogik E4200 is by using the reset button to load the factory defaults.

Before you set a password for the first time, it is a good idea to export the configuration to a file when you have finished setting up your ioLogik E4200. Your configuration can then be easily imported back in to the ioLogik E4200 if you need to reset the ioLogik E4200 due to a forgotten password or for other reasons.

Load Factory Default

This function will reset all of the ioLogik E4200's settings to the factory default values. All previous settings, including the console password will be lost.

Save/Restart

If you change the configuration, do not forget to reboot the system.

Click&Go Introduction

Click&Go logic was developed by Moxa to provide an easy way to set your ioLogik E4200 for Active I/O messaging. In this chapter, we will show you how Click&Go logic works and how to use it to develop your Active I/O messaging program.

The following topics are covered in this chapter:

- ❑ **Overview**
- ❑ **Features**
- ❑ **Click&Go Logic Basics**
- ❑ **Working with Rules**
 - Developing Your Logic Rules
- ❑ **Define Global Variables**
 - Internal Register Settings
 - Timer Settings
 - SNMP Trap Server
 - E-Mail Server
 - Active Message Settings
 - SMS Phone Number Book
- ❑ **IF/THEN/ELSE Statement**
 - IF Conditions
 - THEN/ELSE Actions
- ❑ **Working with Click&Go Rulesets**
 - Activating the Ruleset
 - Ruleset Management Bar
 - Ruleset Import/Export

Overview



Everybody can be a programmer! Moxa's Click&Go event-based control logic for the ioLogik Active Ethernet I/O eliminates the cumbersome programming generally required for data acquisition, alarm messaging, and local control tasks. No knowledge of C-language or PLC ladder is required for field applications. Instead, users familiar with

IF-THEN-ELSE statements will have no problem understanding the Click&Go interface and will be able to control I/O channels and alarm messaging after a few simple steps. The configuration utility also makes the control process easy to define and configure. Simply download the logic to the ioLogik Active Ethernet I/O device and Click&Go will be ready-to-go in no time. Click&Go performs various functions including local I/O status, remote output control, alarm generation and messaging, and event-driven or time-based I/O status reporting. Click&Go eliminates the need for host computers to continually poll I/O devices for status. Instead, the device itself is able to monitor the status of each I/O device and take the appropriate action when the I/O status satisfies a user-defined condition. For example, users may need to configure the ioLogik to send a TCP/UDP message only when the switch attached to DI-0 is turned on. This event-based structure results in a much improved response time and a much reduced load on the host computer's CPU and on network bandwidth. Simple IF-THEN-ELSE statements are used to specify conditions that are required for certain actions to take place. Up to three conditions, three actions and three opposite actions (ELSE), can be combined in a rule, and you can define up to 80 rules. Supported actions include sending SNMP traps or TCP/UDP messages to up to 10 hosts at a time.

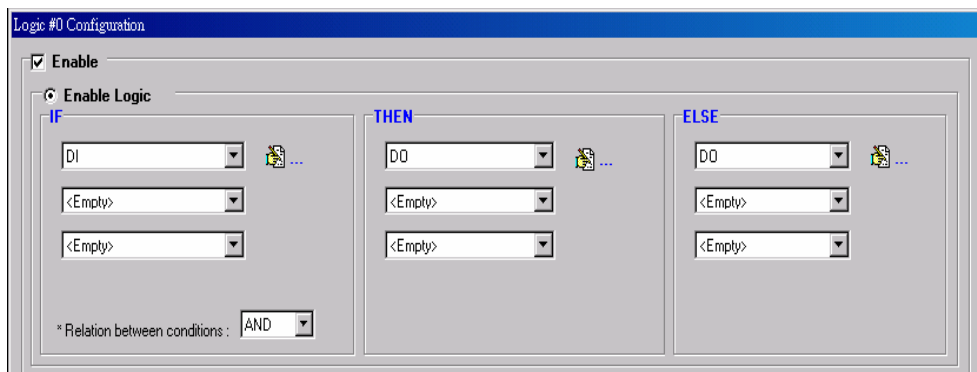

The ioLogik E4200's Active Ethernet I/O system eliminates the need for host computers to continually poll I/O devices for status. Instead, the ioLogik itself is able to monitor the status of each I/O channel and take the appropriate action when the I/O status satisfies a user-defined condition. For example, the ioLogik E4200 could be configured to send a TCP/UDP message only when a temperature sensor attached to TC-00 channel reports a reading of 85°C. This structure results in a much improved response time and a much reduced load on the host computer's CPU and on network bandwidth.

Click&Go Logic was developed to provide an easy and intuitive way to configure when and how I/O information is transmitted over the network. Using simple IF-Then-Else statements, you set the conditions that need to be satisfied and the resulting actions. Up to three conditions and three actions can be combined in any one rule, and up to 80 rules can be defined in a ruleset. Each SNMP trap, TCP/UDP message, up to 10 hosts, and SMS can be transmitted to up to 5 hosts simultaneously.

Features

Click&Go logic's key features are as follows:

80 Rules for Intuitive IF-THEN-ELSE Style Logic

Users do not need any programming experience to use Click&Go. The easy and straightforward IF-THEN-ELSE programming style greatly simplifies the development and installation of I/O applications. With 80 IF-THEN-ELSE rules pre-installed and up to 3 IF conditions and 3 THEN/ELSE outputs or network actions per rule, Click&Go is suitable for most remote monitoring and alarm applications.

Local Monitoring and Local Intelligence

Click&Go can continually monitor the local I/O status for each input channel, trigger the status, or direct it to local output channels.

Remote Control and Control by Remote

Click&Go is capable of accepting control commands from a remote host or an ioLogik. In addition, it can send out commands to remotely control another ioLogik.

Time-stamped Active Messaging

All alarms, messages, e-mail notices, and TCP, UDP, SNMP traps, and SMS are time-stamped with the exact time of the events.

Unicode Active Messaging

All alarms, messages, e-mail notices, and TCP, UDP, SNMP traps, and SMS can be defined in different languages based on the events' context.

Click&Go Logic Basics

To use Click&Go logic, open Modular ioAdmin and log on as administrator from the Adaptor Settings tab. Once you are logged on, go to the Click&Go logic tab. It should appear as follows:

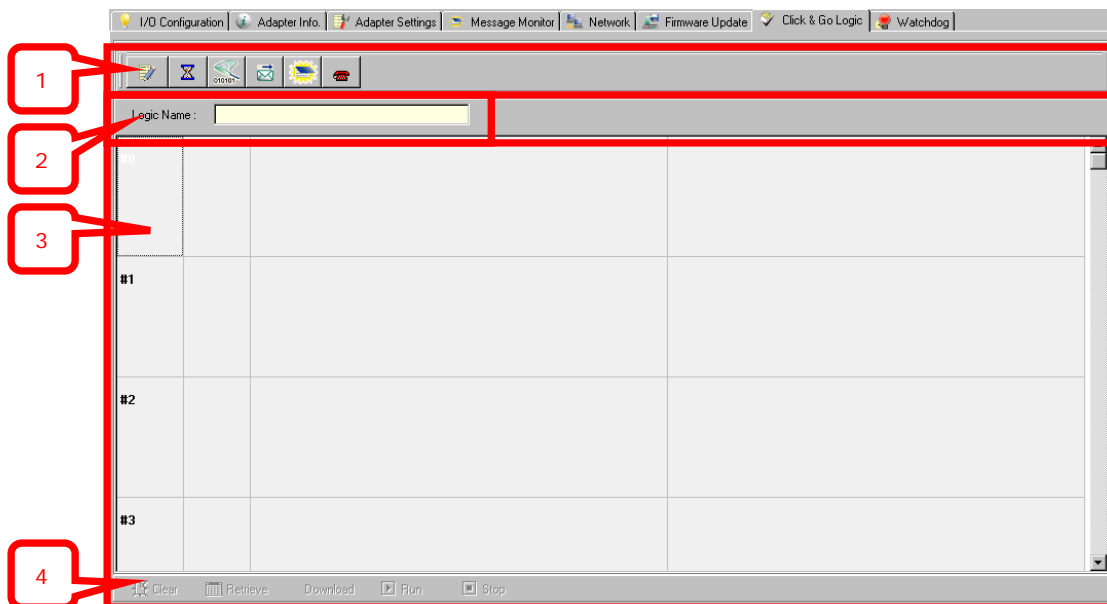

1. **Global Variables:** In this field, you can assign variables for all rules used.
2. **Logic Name:** In this field, you can assign a name for the set of rules.
3. **Rules List:** In this area, each rule's conditions, actions, and status are displayed.
4. **Ruleset Management Bar:** In this area, you manage the ruleset

Working with Rules

Rules are the building blocks of your Active Ethernet I/O system. With rules, you define the exact trigger conditions for transmission of I/O information as well as the content and destination of that information. Output channel operation can also be automated based on input channel trigger conditions.

In the main screen, you will see the list of rules in the current ruleset. Double click on a rule to open that rule's configuration window, or double click on an empty rule to start a new rule.

Logic #0 Configuration

Enable

IF

DI

<Empty>

<Empty>

THEN

AO

<Empty>

<Empty>

ELSE

Remote Action

<Empty>

<Empty>

* Relation between conditions : AND

Equivalent Logic Statement :

```
<IF>
  (Slot0: M-1800 DI-0 OFF)
<THEN>
  (Slot4: M-4210 AO-0 = 0.00 V)
<ELSE>
  (Send Remote Cmd. Set #1 To ... every 0 sec.)
```

OK Cancel

Under Relation between conditions, select AND to specify that all conditions must be satisfied for the actions to take place; select OR to specify that any one of the conditions can be satisfied for the actions to take place.

The configuration window is where the rule is defined. Basic IF-THEN-ELSE logic is used to set up event-based triggers.

The Equivalent Logic Statement at the bottom shows a real-time text-based summary of the rule that you are defining. It can be a useful way to make sure that the rule is designed as you intended.



ATTENTION

The unit of measurement and alias name of I/O channel is defined on the I/O configuration tab. When an I/O channel is used in a Click&Go logic rule, the channel's range, units, and alias name cannot be modified. We strongly recommend configuring these parameters for the I/O channel being used before performing any further configuration or programming.

Developing Your Logic Rules

Each rule consists of three columns. The "IF" column defines I/O conditions, the "THEN" and "ELSE" column defines actions. When the ioLogik detects that the IF conditions have been satisfied, the THEN or ELSE actions will be performed.

After searching and setting up the IP address for an ioLogik Active Ethernet device, Click&Go logic can be developed with the following procedure:

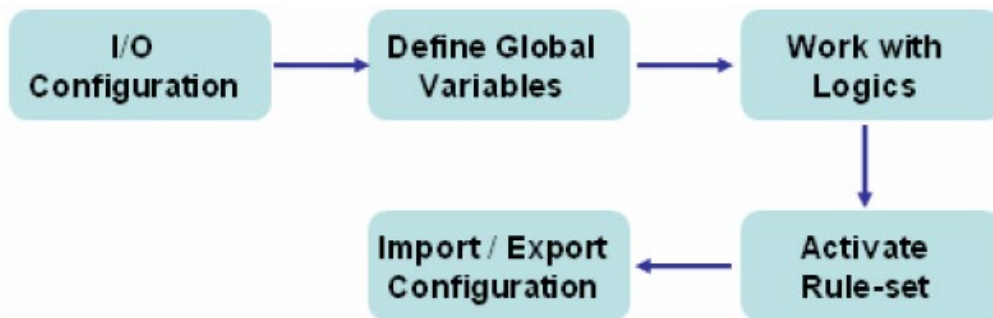

Define Global Variables

Global Variables include **Internal Register Settings**, **Timer Settings**, **SNMP Trap Server**, **E-Mail Server**, and **Active Message Server** and **SMS Phone Number Book**. If these functions are going to be used in a Click&Go ruleset, the default configuration must first be set in the Global Variable Menu Bar.

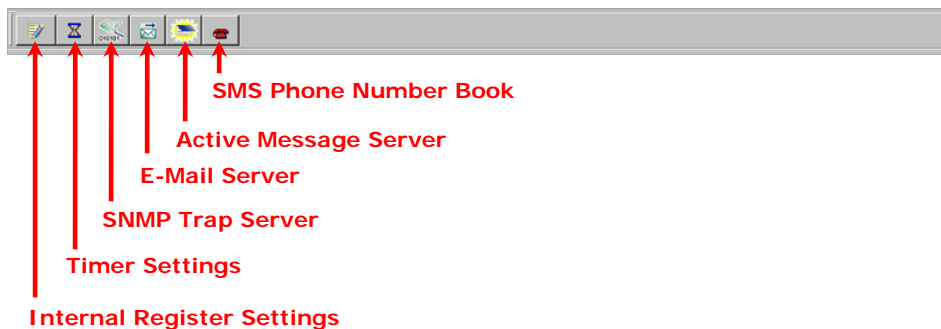

Internal Register Settings

Internal Register is a flag that can be used with the Click&Go logic internally or externally. It allows you to control an output channel used in the Click&Go rule from a remote site. It is useful for database control systems, such as a door access system. The 80 sets of internal registers can be polled and controlled by SCADA software using standard Modbus/TCP format, or can be implemented to redirect the result of one Click&Go logic to another.

The initial value (power-on value) of an internal register is **0**. There are 80 Internal Registers, Reg-0 to Reg-79, which can be assigned values from 0 to 255 during runtime (working value). Detailed Modbus addresses can be retrieved from Modular ioAdmin's exported Modbus Table.

Note that the Modbus address of the internal registers are divided into two parts: (1) the initial value, and (2) the runtime value. The initial value is first activated when the system is powered up, and the runtime value can be changed when Click&Go is running.

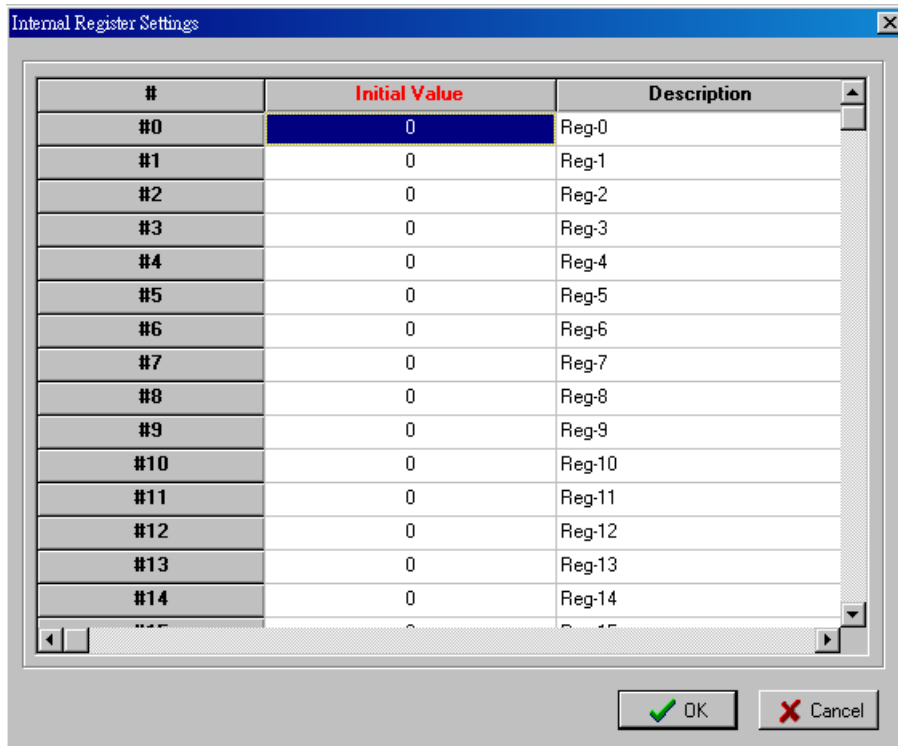

Timer Settings

The **Timer** function allows users to delay an action, to trigger an action to run, or repeat an action. A timer is activated by a change of the logic event. After the timed interval has expired, the output will be performed. There are 80 timers that can be implemented using Click&Go logic, and the default value of their interval is set to **5 seconds** in the **STOP** state. Configure the interval before using them. If the default state is set to **START**, the timer will start when the Click&Go logic is activated. There are 80 Timers, labeled Timer-0 to Timer-79, which can be assigned an initial status of either **START** or **STOP**.

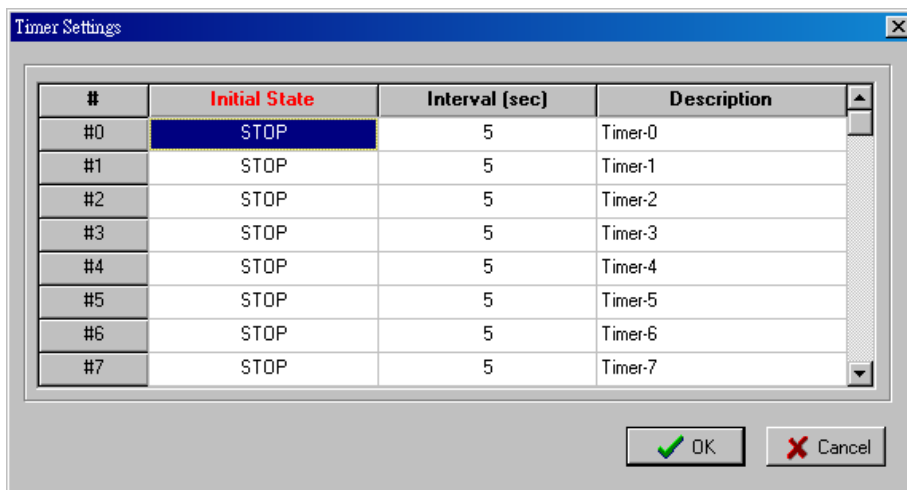

SNMP Trap Server

The ioLogik Active Ethernet Modular I/O provides SNMPv2 (Simple Network Management Protocol) to allow monitoring of the network and I/O devices with SNMP Network Management software. It is useful for building automation and telecom applications. When the system information of an ioLogik is required to be monitored, or a Click &Go logic is defined to update the I/O status via SNMP traps, one or up to 10 SNMP trap servers must be defined.

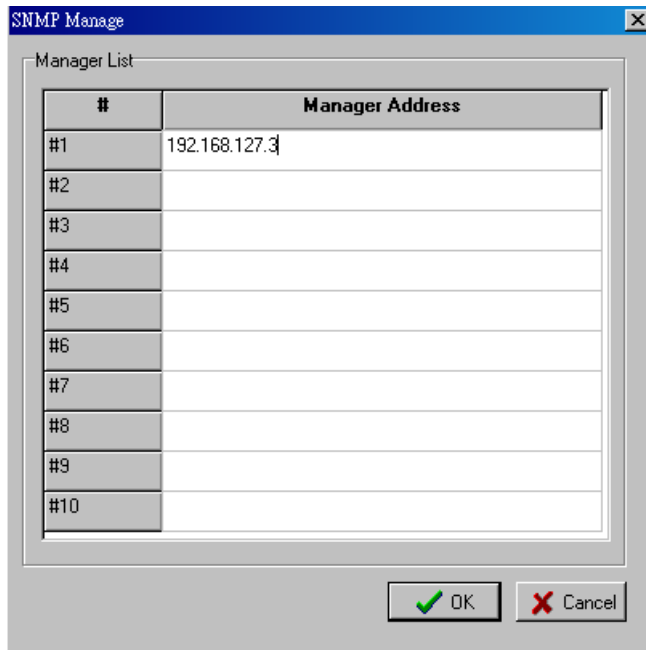

E-Mail Server

The **E-mail Server** configures the parameters of the target e-mail servers and the recipient e-mail addresses. The **Recipient Database** should contain a list of available e-mail addresses for your network environment. The e-mail message defined in the Click&Go logic will be sent to all addresses listed in the **Receiver(s) list**. To add e-mail addresses to the **Available receiver(s) list**, enter the **Name** and **Mail Address** and click the **Add** finger icons to move addresses to the **Recipient Database**; use the **Remove** finger icon to remove it. Under Mail Server Settings, you must configure the address of the SMTP server with your username and password.

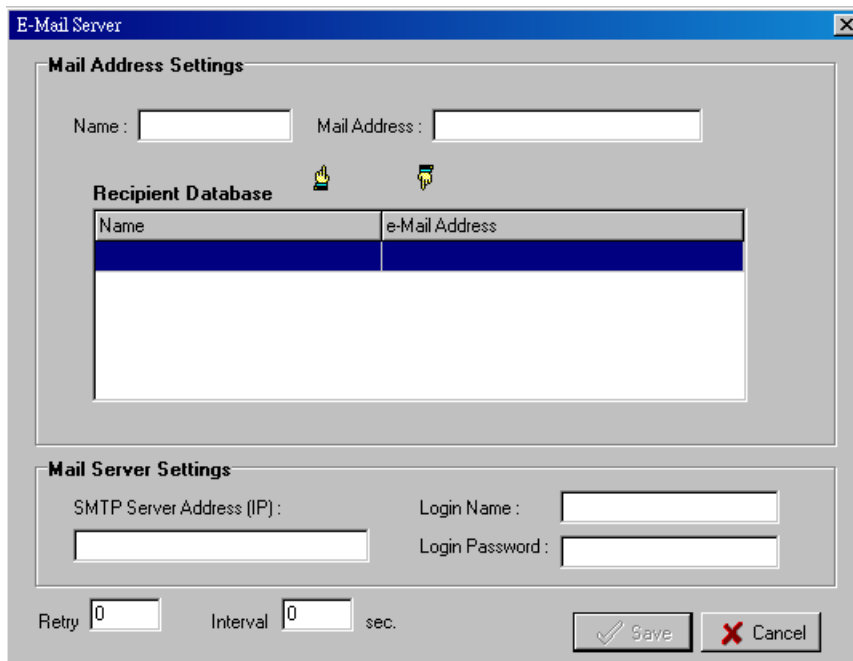

NOTE When using an FQDN (Fully Qualified Domain Name) address, such as ms.moxa.com, users must specify the DNS settings in the ioLogik.

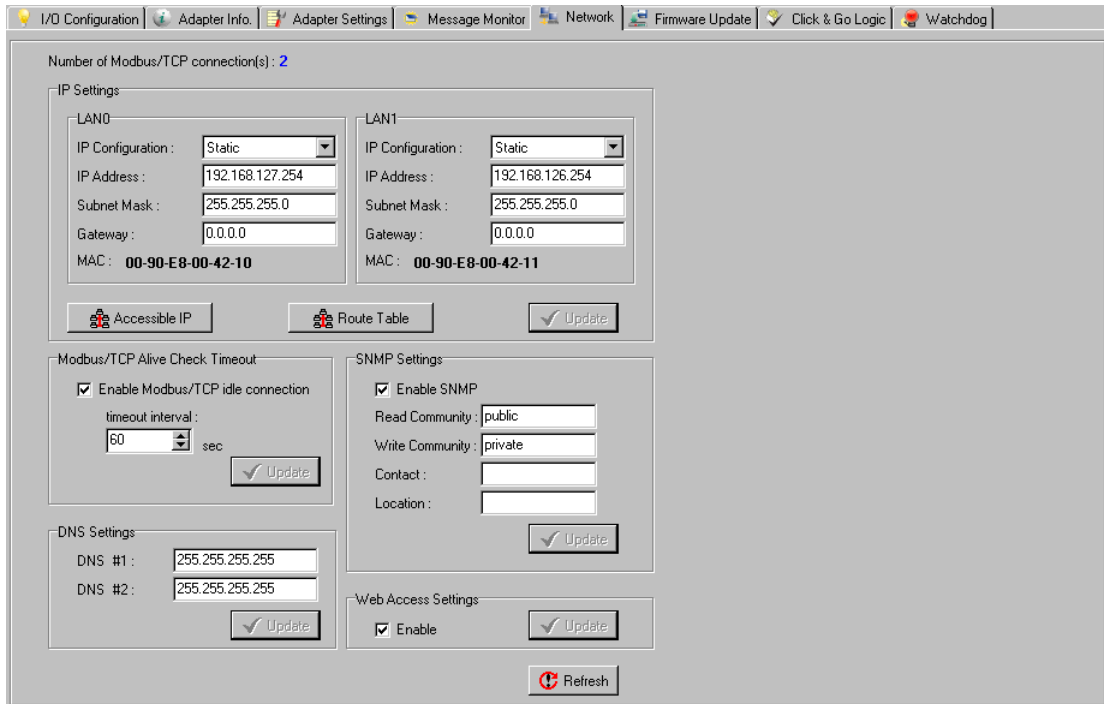

Active Message Settings

Active Message Settings is used to configure one or more destination IP addresses of the Message Servers that receive the event messages generated by the Click&Go logic. Message protocol (TCP or UDP) and the message socket port also need to be configured here. The active message defined in the Click&Go logic will be sent to all addresses listed in the **Message Recipient List**.

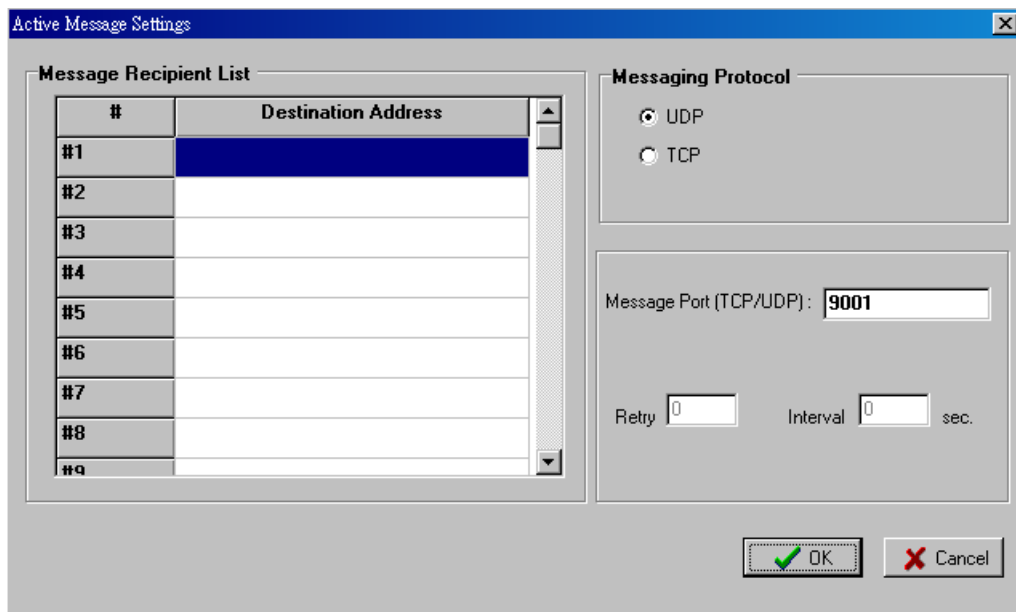

SMS Phone Number Book

The **SMS Phone Number Book** configures 1 to 5 destination Phone Numbers that receive SMS event messages generated by the Click&Go logic. The active message defined in the Click&Go logic will be sent to all phone numbers listed in the **Phone Number List**

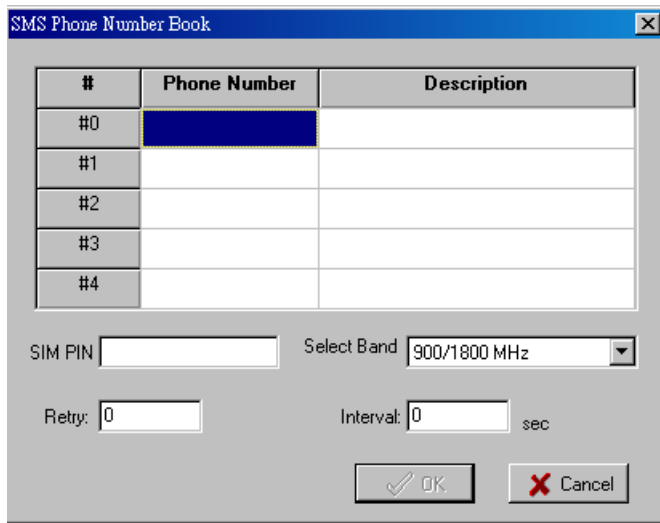

IF/THEN/ELSE Statement

Rules are the building blocks of your ioLogik system. With rules, you define the exact trigger conditions for transmission of I/O information as well as the content and destination of that information.

Click&Go Logic can be defined with the following manner:

IF "A" THEN "B", ELSE "C"

For one control logic rule, three "A"s can be configured, where "A" refers to the IF conditions that trigger an action. These three conditions can be operated on by "AND" or "OR" logic. When using "AND," all three conditions must be true for the result to be true. When using "OR," the result is true if one or more of the three conditions are true.

A1	A2	A3	Result of AND Logic	A1	A2	A3	Result of OR Logic
0	0	0	0	0	0	0	0
0	0	1	0	0	0	1	1
0	1	0	0	0	1	0	1
0	1	1	0	0	1	1	1
1	0	0	0	1	0	0	1
1	0	1	0	1	0	1	1
1	1	0	0	1	1	0	1
1	1	1	1	1	1	1	1

All 80 rules are defined individually and are executed one by one in a loop. The 2nd rule can only be processed after running the 1st rule and the entire ruleset will run from the beginning after the last rule is processed.

Note: Refer to the Click&Go V2 Users Manual for more details.

IF Conditions

IF conditions are events that trigger the THEN/ELSE actions. In the IF column, you can set up to 3 conditions that must be satisfied for the actions under the THEN/ELSE columns to take place. As soon as the IF conditions are satisfied, the specified THEN/ELSE action is performed. For example, an alarm can be activated when a door is opened. Use the dropdown menus to specify the conditions and units of measurement (e.g., DI-0=OFF).

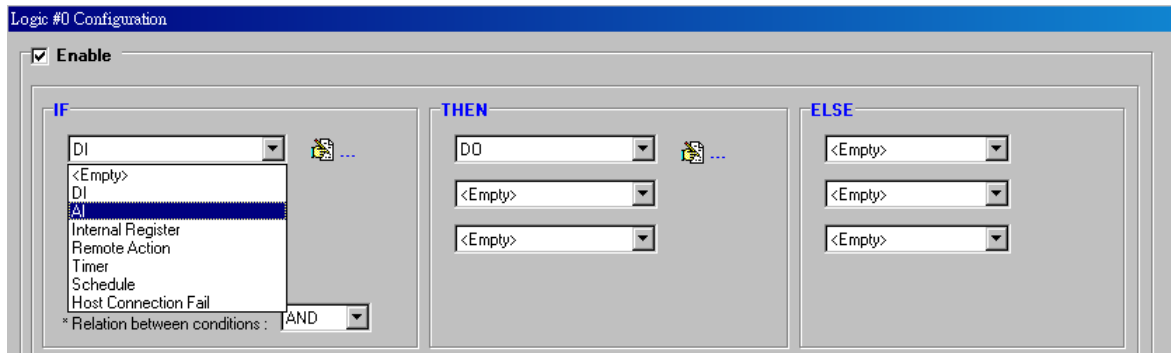

DI

DI refers to the status of a digital input channel. Edge detection can be used to refine the conditions. For example, the condition DI-0=OFF is satisfied for as long as DI-0 remains off. The condition DI-0=ON to OFF, however, is only satisfied the instant the DI-0 turns off. The transition of the status change can also be indicated using the **Change** operator. In this case, it will trigger the related action depending on whether it is ON-to-OFF or OFF-to-ON. Set the IF condition to DI and click the property button to enter the DI Settings window.

AI

AI refers to the readings of an analog input channel. An analog input value is specified to trigger an action. Units of the value are defined by the selected analog modes (voltage or current), or the scaling results. For example, AI-0 > 15 mA could represent the highest allowed level of a water tank.

RTD

RTD refers to the readings of an RTD channel. RTD channels are used to measure temperature. For example, an alarm could be triggered when the temperature reaches 40°C (RTD-0 > 40). Celsius or Fahrenheit temperature units can be selected in the I/O Configuration tab after logging in as administrator.

TC

TC refers to the readings of a TC channel. TC channels are used to measure temperature. For example, an alarm could be triggered when the temperature reaches 500°C (TC-0 > 500). Celsius or Fahrenheit temperature units can be selected in the I/O Configuration tab after logging in as administrator.

Internal Register

Internal Register represents a status flag to link the status of the first logic to the second one. It is most often used with the Timer function or to combine other input statuses together. The Internal Register function also allows a PC to control the ioLogik's local output when the remote output is controlled by the Click&Go log (e.g., digital output, active message, e-mail, or SNMP Trap). Select the IF condition for the Internal Register and click on the property button to enter the **Set Internal Register** window.

The **Used in:** column indicates that this Internal Register is also used in Rule-0, which helps the user to identify the relationship between the rules. The Set Internal Register button allows the user to define the default value of all Internal Registers.

NOTE Internal Registers can be controlled by the Modbus/TCP protocol. Refer to the exported Modbus file for the address list for all the Internal Registers.

Remote Action

In IF conditions, **Remote Action** receives the command from one or more remote ioLogik units. Specifying the ID and the source IP addresses can create an event. For example, a remote push button connected to an ioLogik can trigger a local siren. Select the IF condition for Remote Action and click on the property button to enter the Remote Action Settings window.

Timer

The Timer function can be used to control the timing of a logic rule in the IF conditions. **TIMEOUT** is the only operator here. Possible uses include delaying the triggering of an action, or repeating an action periodically. Select the IF condition for Timer and click on the property button to enter the Internal Register Settings window.

The **Used in:** column indicates that this Timer is also used in Rule-0, which helps the user identify the relationship between rules. The Set Timer button helps define the default value for the Timer.

Schedule

The Schedule function allows users to set a starting point or time period for a task. For example, if a pump is required to start at 9: 00 PM and stop at 11:00 PM every Monday, Wednesday, and Friday, select the IF condition for Schedule and click on the property button to enter the settings window. For recurrent actions, select the Recurrence checkbox and select the appropriate weekdays. If a time period needs to be defined, specify the stop date in the range column.

Host Connection Fail

The Host Connection Fail function refers to when an ioLogik detects the timeout from a remote Modbus/TCP host and directs it to one of the IF conditions of the Click&Go logic. Timeout can be used to trigger an action such as resetting the attached power line on a DO or relay channel to reboot the device. Select the IF condition for Host Connection Fail and click on the property button to enter the settings window. The **Host Connection Fail** condition means that the two ioLogik E4200 connections were lost at same time after a specific period.

THEN/ELSE Actions

Under the THEN column, you can specify up to 3 actions that will be performed when the IF conditions are satisfied; 3 actions under the ELSE column will also be performed when the IF condition is NOT satisfied. Possible actions include changing the status of a DO channel, or sending a message by SNMP trap, TCP, UDP, SMS, or e-mail.

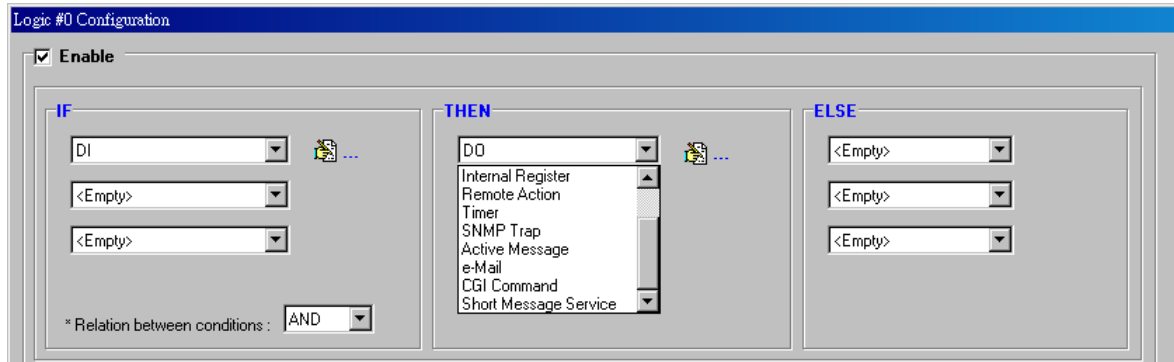

DO

DO refers to the action of controlling the local digital output channels that react to the IF conditions. Select the THEN/ELSE action for DO and click on the property button to enter the DO Settings window.

NOTE A Relay output channel is also referred to as a DO channel in the THEN/ELSE action fields.

AO

AO refers to the local control of the analog output channels, including voltage and current. Analog output can be used to control the open angle of a valve that controls the movement of a solar panel.

Internal Register

The Internal Register represents a status flag to link the status of the first logic to the second one by specifying other actions in the THEN/ELSE fields. Values from 0 to 255 can be configured here. Select the THEN/ELSE action to Internal Register and click on the property button to enter the Internal Register Settings window. In the above figure, the **Used in:** column indicates that this Internal Register is also used in Rule-0, which helps the user identify the relationship between the rules. The Set Internal Register button will help to define the default value of all the registers.

NOTE Internal Register can be controlled by Modbus/TCP protocol, refer to the appendix for the address list for all the Internal Registers.

Remote Action

When responding to a proper IF condition, Remote Action in the THEN/ELSE action fields sends out a specific command ID to the remote ioLogik to create a remote IF condition. Select the THEN/ELSE action for Remote Action and click on the property button to enter the Remote Action Settings window. After specifying the command ID, click on the Remote IP button to fill in the target ioLogik IP addresses.

Timer

The Timer function can be used to control the time settings of a logic rule. Actions such as **START**, **STOP**, and **RESTART** can be configured here. Select the IF condition to Timer and click on the property button to enter the Internal Register Settings window. In the above figure, the **Used in:** column indicates that this Timer is also used in Rule-0, which helps the user identify the relationship between the rules. The Set Timer button defines the default value for the Timer.

NOTE The **STOP** operator stops the timer and returns to **0**; the **RESTART** operator clears and restarts the timer.



ATTENTION

STOP or **RESTART** should always be used to reset or restart the timer. If you do not use these operators, the Timer function will only be triggered once.

SNMP Trap

The SNMP Trap function sends an SNMP trap to one or more IP destinations. You can select a trap number between 1 and 80. (You may need to consult with your network administrator to determine how trap numbers are used and defined on your network.) Select the THEN/ELSE action for the SNMP Trap and click on the property button to enter the SNMP Trap Settings window. You can also bind the status of up to three I/O channels within each trap. Click the Set SNMP button to specify up to 10 recipients for the SNMP trap.

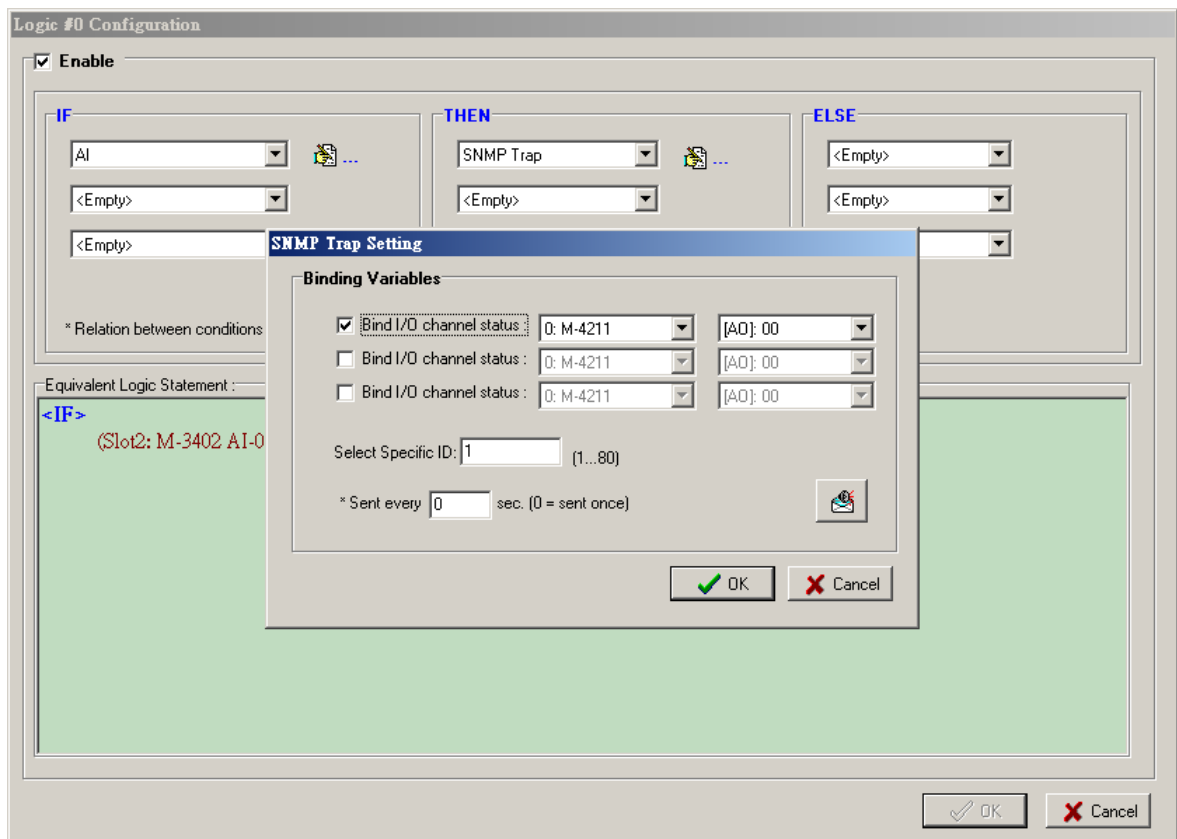

Active Message

In response to a proper IF condition, the Active Message function sends a customized message to one or more IP destinations using TCP or UDP packets. Select the THEN/ELSE action to Active Message and click on the property button to enter the Message Content Settings window.

Enter your desired message in the Message Content column. Dynamic fields such as time, date, IP address, and I/O status can be inserted in your message by clicking Keyword Lookup. Messages are sent in ASCII by default, but can be sent in HEX by selecting the **Message Format** as **HEX (separated by ',')** checkbox or sent in Unicode by selecting the **Message Format** as **UNICODE (UCS-2)** checkbox. Click the Set Active Message button to configure the default parameters, such as the messaging protocol (TCP or UDP), socket port (9001 by default), and up to 10 target message servers.

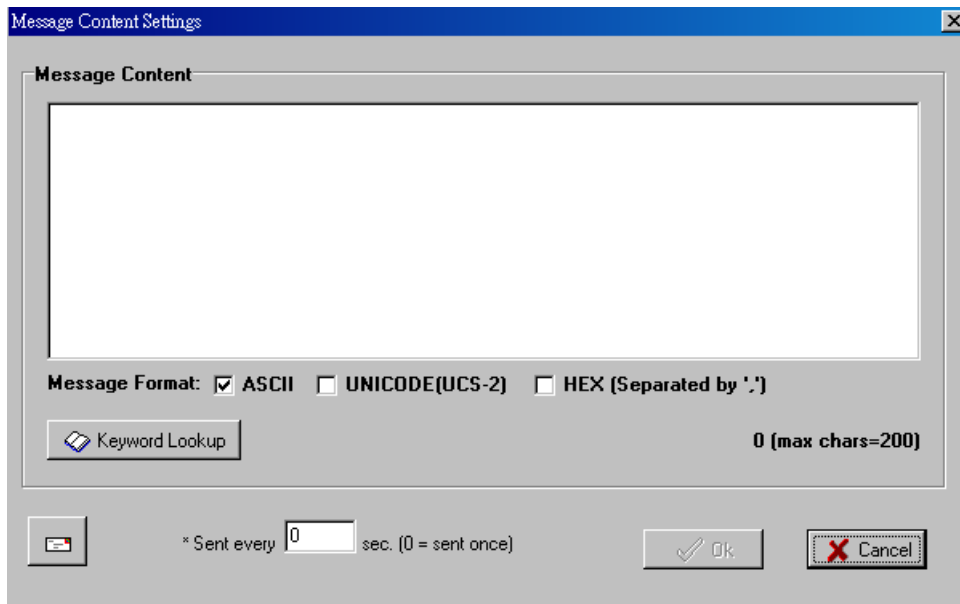

Messages can be received by a program using standard sockets, the Moxa MXIO library, or ioAdmin's Message Monitor.

When sending a message in HEX, each HEX value must be delimited by commas. View the incoming message in the **Message Monitor** tab and select the **Toggle HEX** checkbox. Note numbers that are control characters will not show up in the Message Monitor.

E-mail

The E-mail function sends a customizable e-mail to one or more mail boxes or Blackberrys. Select the THEN/ELSE action to e-mail and click on the property button to enter the Mail Settings window. After entering the subject of an e-mail, enter the message in the Mail Content area. Dynamic fields such as time, date, IP address, and I/O status can be inserted in your message by clicking Keyword Lookup.

NOTE Content in the same logic entry can be sent by either Active Message or e-mail, in which case the content of the messages will be the same. If you would like to send an Active Message and e-mail based on the same event, but with different content, you will need to use two separate logic entries, one for the Active Message and one for the e-mail.

SMTP server information, including username/password and the recipient database, can be configured by clicking the Set Mail Address button. Clicking the finger icon can move the selected address from the Recipient Database to the Recipient List. To manually add e-mail addresses to the Recipient Database, enter the Name and Mail Address and click Add. Once the address has been added to the Recipient Database, use the finger icons to move it to or from the Recipient List.

CGI Command

Not only do the ioLogik products support CGI commands, they also allow the Click&Go logic to interact with proper IF conditions and send out CGI commands to IP Video devices such as the Moxa V351 video server or VPort 25 IP camera. Support for user-defined CGI commands in the Click&Go THEN/ELSE action turns the ioLogik product into the expansion I/O controller for these video devices. For example, setting a trigger to focus and taking a snapshot when there is an intrusion. Select the THEN/ELSE actions for the CGI command and click on the property button to enter the CGI Command Settings window.

Short Message Service (SMS)

The SMS function sends a customizable SMS to up to 5 mobile phones. Select the THEN/ELSE action to Short Message Service and click on the property button to enter the Phone setting window. After entering the subject of an SMS, enter the message in the Message Content area. Dynamic fields such as time, date, IP address, and I/O status can be inserted in your message by clicking Keyword Lookup

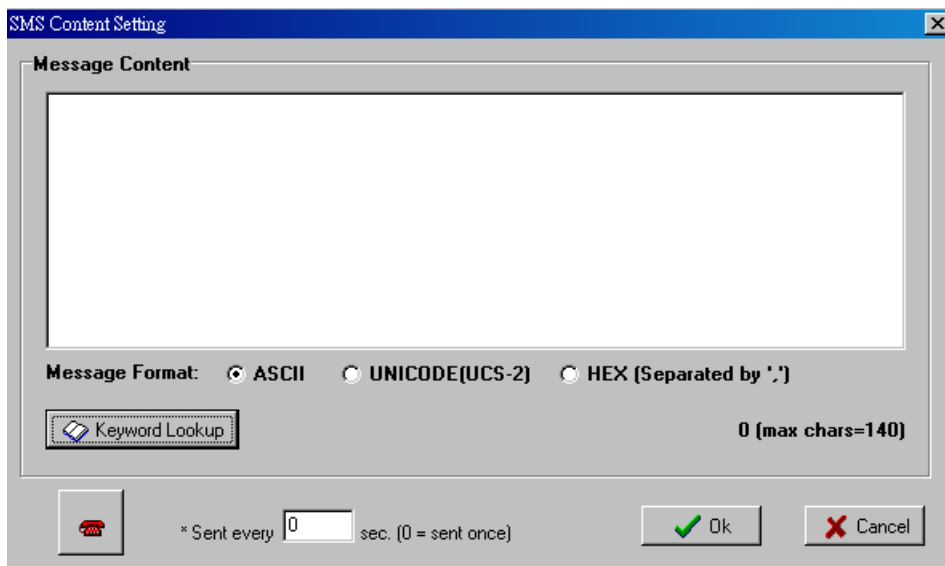

Working with Click&Go Rulesets

Activating the Ruleset

In the Click&Go tab, the rules that are displayed in the Click&Go Logic tab comprise the current ruleset, which acts as the brains of your ioLogik system. The ruleset must be activated for the ioLogik to commence local control operation, as follows:

1. The ruleset must first be downloaded from Modular ioAdmin to the ioLogik. To download the ruleset, click Download from the Ruleset Management bar.
2. After the ruleset has been downloaded, Modular ioAdmin will prompt to restart the ioLogik automatically after clicking **yes** to confirm. Do not use the reset button, as that will load all factory defaults and erase your ruleset from memory.



3. After the ioLogik has been restarted, the ruleset must be activated. After logging in to Modular ioAdmin as administrator, go to the Click&Go Logic tab and click Run in the Ruleset Management bar to activate the ruleset.

When the ruleset has been activated, it will remain active even when the ioLogik is disconnected from the host computer or from the network. If the ioLogik is turned off, Active Ethernet I/O operation will resume when it is turned back on. This allows you to use the ioLogik I/O for PC-independent automation.

Ruleset Management Bar

On the Click&Go tab, when the ruleset has been activated it will remain active even when the ioLogik is disconnected from the host computer or from the network. If the ioLogik is turned off, Active Ethernet I/O operation will resume when it is turned back on. This allows you to use the ioLogik E4200 for PC-independent automation.

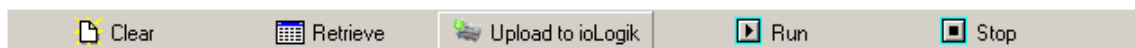

- **Clear:** Erases the ruleset in both Modular ioAdmin and the ioLogik I/O series.
- **Retrieve:** Copies the ruleset from the ioLogik I/O series into Modular ioAdmin.
- **Upload to ioLogik:** Copies the ruleset from Modular ioAdmin onto the ioLogik I/O series.
- **Run:** Activates the ruleset that the ioLogik booted up with.
- **Stop:** De-activates the Click&Go ruleset and returns the ioLogik to normal, passive operation.

Ruleset Import/Export

Although rulesets alone cannot be imported and exported, the entire system configuration, including the current ruleset, can be imported and exported. As you make changes to a ruleset, you can export the system configuration in order to save that ruleset.

Pinouts and Cable Wiring

Port Pinout Diagrams

Ethernet Port Pinouts

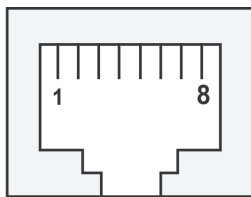

Pin	Signal
1	Tx+
2	Tx-
3	Rx+
6	Rx-

Serial Port Pinouts

RS-232 Network Adaptor Pin Assignment.

Pin	RS-232 Signal
1	DCD (in)
2	RxD (in)
3	TxD (out)
4	DTR (out)
5	GND
6	DSR (in)
7	RTS (out)
8	CTS (in)
9	---

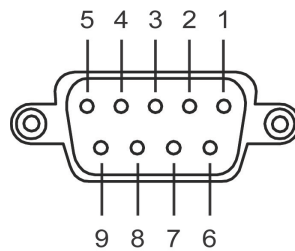

Using Modbus/TCP

The ioLogik E4200 Modbus map has three categories:

1. **IO image map:** For all input and output channels installed in the system.
2. **Module configuration map:** Settings for each module.
3. **System configuration map:** Settings for the entire I/O system.

The following topics are covered in this appendix:

❑ System Configuration Map Addresses

- 3xxxx Read only Registers (Support function 4)
- 4xxxx Read/Write Registers (support function 3, 6, 16)

❑ I/O Image Map Addressing

❑ Fixed mode (default mode):

❑ Dynamic Mode

❑ Module Configuration Map

❑ DO Module Configuration Map

- Input Register Map (R)
- Holding Register Map (R/W)
- Coil Map (R/W)

❑ DI Module Configuration Map:

- Input Register Map(R)
- Holding Register Map(R/W)

❑ AO Module Configuration Map

- Input Register Map (R)
- Holding Register Map (R/W)

❑ AI Module Configuration Map

- Input Register Map (R)
- Holding Register Map (R/W)

❑ TC Module Configuration Map:

- Input Register Map (R)
- Holding Register Map (R/W)

❑ RTD Module Configuration Map

- Input Register Map (R)
- Holding Register Map (R/W)

❑ Internal Registers

❑ Function 8

System Configuration Map Addresses

3xxxx Read only Registers (Support function 4)

System information			
Reference	Address	Data Type	Description
324577	0x6000	1 word	Reserved
324578	0x6001	1 word	Unit ID (Ethernet=1)
324579	0x6002	1 word	Product Code=0x4200
324580	0x6003 to 0x6016	20 word	Reserved
324600	0x6017 to 0x602A	20 word	Product name string="E4200 Active Ethernet Network Adaptor"
324620	0x602B to 0x602C	2 word	Product serial number (decimal)
324622	0x602D to 0x602E	2 word	Firmware revision: Word 0 Hi byte = major (A) Word 0 Lo byte = minor (B) Word 1 Hi byte = release (C) Word 1 Lo byte = build (D) format is A.B.C.D
324624	0x602F to 0x6030	2 word	Firmware release date High word = 0x2006 Low word = 0x1101 firmware release date is Nov. 1, 2006
324626	0x6031	1 word	Number of TCP connected
324627	0x6032	1 word	Ethernet Interface-0 speed, 0x10(10Mbps) or 0x100(100Mbps)
324628	0x6033	1 word	Ethernet Interface-1 speed, 0x10(10Mbps) or 0x100(100Mbps)
324629	0x6034	3 word	Ethernet Interface-0 MAC
324632	0x6037	3 word	Ethernet Interface-1 MAC
324635	0x603A	1 word	Reserved
324636	0x603B	1 word	Reserved
324637	0x603C	1 word	Reserved
324638	0x603D to 0x603E	2 word	System Elapsed Time (in sec)
324640	0x603F	1 word	Modbus/RTU Unit ID=1
324641	0x6040 to 0x6041	2 word	Reserved
324643	0x6042	1 word	Reserved
324644	0x6043to0x6062	32 word	Reserved
324676	0x6063	1 word	Reserved
324677	0x6064	1 word	Number of attached modules
324678	0x6065	1 word	Reserved
324679	0x6066	1 word	Reserved
324680	0x6067	1 word	LEDs status Low-byte: SYS-LED High-byte: IO-LED bit0: OFF→0x01 bit1: Green→0x02 bit2: Red→0x04 bit3: Flashing Green→0x08 bit4: Flashing Red→0x10 bit5: Green&Read→0x20(reserved)
324681	0x6068	1 word	Reserved

324682	0x6069	1 word	GSM modem error code: 0:OK 1:No SIM 2:Error PIN 3:Not connected 4:Can't register to GSM 5:don't care 6: Init modem error
324683	0x606A	1 word	GSM RSSI 99: Invalid 0 to 12: Low 13 to 20: Average >20: Good
324684	0x606B	1 word	Reserved
324685	0x606C to 0x607C	16 word	Moxa code of each attached module: Address 0x606C: Slot0 Address 0x606D: Slot1 Address 0x606E: Slot2 Address 0x607C: Slot15
324681	0x6086 to 0x612E	144 word	Reserved
324903	0x6146	1 word	Modbus working addressing mode: 0: Fixed mode 1: Dynamic mode

4xxxx Read/Write Registers (support function 3, 6, 16)

System information			
Reference	Address	Data Type	Description
424577	0x6000 to 0x6001	2 word	LAN-0 IP address (need reboot) Word 0 Hi byte = 192 (0xC0) Word 0 Lo byte = 168 (0xA8) Word 1 Hi byte = 15 (0x0F) Word 1 Lo byte = 1 (0x01) IP address is "192.168.15.1"
424579	0x6002 to 0x6003	2 word	LAN-1 IP address (need reboot) Word 0 Hi byte = 192 (0xC0) Word 0 Lo byte = 168 (0xA8) Word 1 Hi byte = 14 (0x0E) Word 1 Lo byte = 2 (0x02) IP address is "192.168.14.2"
424581	0x6004 to 0x6005	2 word	LAN-0 Subnet mask (need reboot) Word 0 Hi byte = 255 Word 0 Lo byte = 255 Word 1 Hi byte = 255 Word 1 Lo byte = 0 Subnet mask is "255.255.255.0"
424583	0x6006 to 0x6007	2 word	LAN-1 Subnet mask (need reboot) Word 0 Hi byte = 255 Word 0 Lo byte = 255 Word 1 Hi byte = 255 Word 1 Lo byte = 0 Subnet mask is "255.255.255.0"
424585	0x6008 to 0x6009	2 word	LAN-0 Geteway (need reboot)

			Word 0 Hi byte = 192 Word 0 Lo byte = 168 Word 1 Hi byte = 15 Word 1 Lo byte = 1 Geteway is "192.168.15.1"
424587	0x600A to 0x600B	2 word	LAN-1 Geteway (need reboot) Word 0 Hi byte = 192 Word 0 Lo byte = 168 Word 1 Hi byte = 15 Word 1 Lo byte = 1 Geteway is "192.168.15.1"
424589	0x600C	1 word	LAN-0 IP Acquisition mode
424590	0x600D	1 word	LAN-1 IP Acquisition mode
424591	0x600E to 0x6011	4 word	DNS Server 1/ Server 2 IP Address Word 0 Hi byte = 192 Word 0 Lo byte = 168 Word 1 Hi byte = 15 Word 1 Lo byte = 1 Word 2 Hi byte = 192 Word 2 Lo byte = 168 Word 3 Hi byte = 15 Word 3 Lo byte = 2 DNS Server 1 IP Address is "192.168.15.1" DNS Server 2 IP Address is "192.168.15.2"
424595	0x6012	1 word	Timeout for idle TCP/IP connection In sec
424596	0x6013 to 0x6018	6 word	System Local Time: Word 0= Sec: 00-59 Word 1= Min: 00-59 Word 2= Hour: 00-23 Word 3= Day: 01-31 Word 4= Month: 01-12 Word 5= Year: 2000-2099
424602	0x6019	1 word	System Local Time zone (1 to 63), refer to appendix time zone code.
424603	0x601A to 0x601F	6 word	Reserved
424609	0x6020	1 word	Enable/disable web access Enable=1, disable=0
424610	0x6021 to 0x6034	20 word	Reserved
424630	0x6035	5 word	Reserved
424635	0x603A	1 word	Host connection loss Time Out value (enter safe state)
424636	0x603B	1 word	Host connection loss Time Out flag (enter safe state)
424637	0x603C	1 word	SNMP Enable
424638	0x603D to 0x6046	10 word	SNMP community
424648	0x6047 to 0x605A	20 word	SNMP Contact
424669	0x605C to 0x606F	20 word	SNMP Location
424690	0x6071	1 word	Reserved
424691	0x6072 to 0x607B	10 word	Reserved
424701	0x607C to 0x608F	20 word	Reserved
424721	0x6090 to 0x60A3	20 word	IP Allow Mask List
424741	0x60A4 to 0x60A5	2 word	System Time Server Address

			Word 0 Hi byte = 192 Word 0 Lo byte = 168 Word 1 Hi byte = 15 Word 1 Lo byte = 1 Time Server Address is "192.168.15.1"
424761	0x60B8 to 0x60CB	20 word	Log server
424781	0x60CC	1 word	Log server port
424782	0x60CD to 0x60EA	30 word	Adaptor location
424812	0x60EB to 0x6108	30 word	Adaptor name
424842	0x6109	1 word	Reserved
424843	0x610A	1 word	Modbus addressing mode 0:Fixed mode 1:Dynamic mode
424844	0x610B to 0x611A	16 word	Reserved
424860	0x611B	1 word	Reserved
424861	0x611C to 0x611D	2 word	Reserved
424863	0x611E	1 word	Reserved
424864	0x611F	1 word	Reserved
424865	0x6120 to 0x6184	101 word	Reserved
424966	0x6185 to 0x6194	16 word	Reserved
432769	0x8000	1 word	Reserved
432850	0x8051 to 0x8058	8 word	Logic & Go Name
434422	0x8675	1 word	Internal Register 00 Value (Power On)
434423	0x8676	1 word	Internal Register 01 Value (Power On)
434424	0x8677	1 word	Internal Register 02 Value (Power On)
434425	0x8678	1 word	Internal Register 03 Value (Power On)
434426	0x8679	1 word	Internal Register 04 Value (Power On)
434427	0x867A	1 word	Internal Register 05 Value (Power On)
434428	0x867B	1 word	Internal Register 06 Value (Power On)
434429	0x867C	1 word	Internal Register 07 Value (Power On)
434430	0x867D	1 word	Internal Register 08 Value (Power On)
434431	0x867E	1 word	Internal Register 09 Value (Power On)
434432	0x867F	1 word	Internal Register 10 Value (Power On)
434433	0x8680	1 word	Internal Register 11 Value (Power On)
434434	0x8681	1 word	Internal Register 12 Value (Power On)
434435	0x8682	1 word	Internal Register 13 Value (Power On)
434436	0x8683	1 word	Internal Register 14 Value (Power On)
434437	0x8684	1 word	Internal Register 15 Value (Power On)
434438	0x8685	1 word	Internal Register 16 Value (Power On)
434439	0x8686	1 word	Internal Register 17 Value (Power On)
434440	0x8687	1 word	Internal Register 18 Value (Power On)
434441	0x8688	1 word	Internal Register 19 Value (Power On)
434442	0x8689	1 word	Internal Register 20 Value (Power On)
434443	0x868A	1 word	Internal Register 21 Value (Power On)
434444	0x868B	1 word	Internal Register 22 Value (Power On)
434445	0x868C	1 word	Internal Register 23 Value (Power On)
434446	0x868D	1 word	Internal Register 24 Value (Power On)
434447	0x868E	1 word	Internal Register 25 Value (Power On)
434448	0x868F	1 word	Internal Register 26 Value (Power On)
434449	0x8690	1 word	Internal Register 27 Value (Power On)
434450	0x8691	1 word	Internal Register 28 Value (Power On)
434451	0x8692	1 word	Internal Register 29 Value (Power On)
434452	0x8693	1 word	Internal Register 30 Value (Power On)

434453	0x8694	1 word	Internal Register 31 Value (Power On)
434454	0x8695	1 word	Internal Register 32 Value (Power On)
434455	0x8696	1 word	Internal Register 33 Value (Power On)
434456	0x8697	1 word	Internal Register 34 Value (Power On)
434457	0x8698	1 word	Internal Register 35 Value (Power On)
434458	0x8699	1 word	Internal Register 36 Value (Power On)
434459	0x869A	1 word	Internal Register 37 Value (Power On)
434460	0x869B	1 word	Internal Register 38 Value (Power On)
434461	0x869C	1 word	Internal Register 39 Value (Power On)
434462	0x869D	1 word	Internal Register 40 Value (Power On)
434463	0x869E	1 word	Internal Register 41 Value (Power On)
434464	0x869F	1 word	Internal Register 42 Value (Power On)
434465	0x86A0	1 word	Internal Register 43 Value (Power On)
434466	0x86A1	1 word	Internal Register 44 Value (Power On)
434467	0x86A2	1 word	Internal Register 45 Value (Power On)
434468	0x86A3	1 word	Internal Register 46 Value (Power On)
434469	0x86A4	1 word	Internal Register 47 Value (Power On)
434470	0x86A5	1 word	Internal Register 48 Value (Power On)
434471	0x86A6	1 word	Internal Register 49 Value (Power On)
434472	0x86A7	1 word	Internal Register 50 Value (Power On)
434473	0x86A8	1 word	Internal Register 51 Value (Power On)
434474	0x86A9	1 word	Internal Register 52 Value (Power On)
434475	0x86AA	1 word	Internal Register 53 Value (Power On)
434476	0x86AB	1 word	Internal Register 54 Value (Power On)
434477	0x86AC	1 word	Internal Register 55 Value (Power On)
434478	0x86AD	1 word	Internal Register 56 Value (Power On)
434479	0x86AE	1 word	Internal Register 57 Value (Power On)
434480	0x86AF	1 word	Internal Register 58 Value (Power On)
434481	0x86B0	1 word	Internal Register 59 Value (Power On)
434482	0x86B1	1 word	Internal Register 60 Value (Power On)
434483	0x86B2	1 word	Internal Register 61 Value (Power On)
434484	0x86B3	1 word	Internal Register 62 Value (Power On)
434485	0x86B4	1 word	Internal Register 63 Value (Power On)
434486	0x86B5	1 word	Internal Register 64 Value (Power On)
434487	0x86B6	1 word	Internal Register 65 Value (Power On)
434488	0x86B7	1 word	Internal Register 66 Value (Power On)
434489	0x86B8	1 word	Internal Register 67 Value (Power On)
434490	0x86B9	1 word	Internal Register 68 Value (Power On)
434491	0x86BA	1 word	Internal Register 69 Value (Power On)
434492	0x86BB	1 word	Internal Register 70 Value (Power On)
434493	0x86BC	1 word	Internal Register 71 Value (Power On)
434494	0x86BD	1 word	Internal Register 72 Value (Power On)
434495	0x86BE	1 word	Internal Register 73 Value (Power On)
434496	0x86BF	1 word	Internal Register 74 Value (Power On)
434497	0x86C0	1 word	Internal Register 75 Value (Power On)
434498	0x86C1	1 word	Internal Register 76 Value (Power On)
434499	0x86C2	1 word	Internal Register 77 Value (Power On)
434500	0x86C3	1 word	Internal Register 78 Value (Power On)
434501	0x86C4	1 word	Internal Register 79 Value (Power On)
434945	0x8880	1 word	Internal Register 00 Value (Working)
434946	0x8881	1 word	Internal Register 01 Value (Working)
434947	0x8882	1 word	Internal Register 02 Value (Working)
434948	0x8883	1 word	Internal Register 03 Value (Working)

434949	0x8884	1 word	Internal Register 04 Value (Working)
434950	0x8885	1 word	Internal Register 05 Value (Working)
434951	0x8886	1 word	Internal Register 06 Value (Working)
434952	0x8887	1 word	Internal Register 07 Value (Working)
434953	0x8888	1 word	Internal Register 08 Value (Working)
434954	0x8889	1 word	Internal Register 09 Value (Working)
434955	0x888A	1 word	Internal Register 10 Value (Working)
434956	0x888B	1 word	Internal Register 11 Value (Working)
434957	0x888C	1 word	Internal Register 12 Value (Working)
434958	0x888D	1 word	Internal Register 13 Value (Working)
434959	0x888E	1 word	Internal Register 14 Value (Working)
434960	0x888F	1 word	Internal Register 15 Value (Working)
434961	0x8890	1 word	Internal Register 16 Value (Working)
434962	0x8891	1 word	Internal Register 17 Value (Working)
434963	0x8892	1 word	Internal Register 18 Value (Working)
434964	0x8893	1 word	Internal Register 19 Value (Working)
434965	0x8894	1 word	Internal Register 20 Value (Working)
434966	0x8895	1 word	Internal Register 21 Value (Working)
434967	0x8896	1 word	Internal Register 22 Value (Working)
434968	0x8897	1 word	Internal Register 23 Value (Working)
434969	0x8898	1 word	Internal Register 24 Value (Working)
434970	0x8899	1 word	Internal Register 25 Value (Working)
434971	0x889A	1 word	Internal Register 26 Value (Working)
434972	0x889B	1 word	Internal Register 27 Value (Working)
434973	0x889C	1 word	Internal Register 28 Value (Working)
434974	0x889D	1 word	Internal Register 29 Value (Working)
434975	0x889E	1 word	Internal Register 30 Value (Working)
434976	0x889F	1 word	Internal Register 31 Value (Working)
434977	0x88A0	1 word	Internal Register 32 Value (Working)
434978	0x88A1	1 word	Internal Register 33 Value (Working)
434979	0x88A2	1 word	Internal Register 34 Value (Working)
434980	0x88A3	1 word	Internal Register 35 Value (Working)
434981	0x88A4	1 word	Internal Register 36 Value (Working)
434982	0x88A5	1 word	Internal Register 37 Value (Working)
434983	0x88A6	1 word	Internal Register 38 Value (Working)
434984	0x88A7	1 word	Internal Register 39 Value (Working)
434985	0x88A8	1 word	Internal Register 40 Value (Working)
434986	0x88A9	1 word	Internal Register 41 Value (Working)
434987	0x88AA	1 word	Internal Register 42 Value (Working)
434988	0x88AB	1 word	Internal Register 43 Value (Working)
434989	0x88AC	1 word	Internal Register 44 Value (Working)
434990	0x88AD	1 word	Internal Register 45 Value (Working)
434991	0x88AE	1 word	Internal Register 46 Value (Working)
434992	0x88AF	1 word	Internal Register 47 Value (Working)
434993	0x88B0	1 word	Internal Register 48 Value (Working)
434994	0x88B1	1 word	Internal Register 49 Value (Working)
434995	0x88B2	1 word	Internal Register 50 Value (Working)
434996	0x88B3	1 word	Internal Register 51 Value (Working)
434997	0x88B4	1 word	Internal Register 52 Value (Working)
434998	0x88B5	1 word	Internal Register 53 Value (Working)
434999	0x88B6	1 word	Internal Register 54 Value (Working)
435000	0x88B7	1 word	Internal Register 55 Value (Working)
435001	0x88B8	1 word	Internal Register 56 Value (Working)

435002	0x88B9	1 word	Internal Register 57 Value (Working)
435003	0x88BA	1 word	Internal Register 58 Value (Working)
435004	0x88BB	1 word	Internal Register 59 Value (Working)
435005	0x88BC	1 word	Internal Register 60 Value (Working)
435006	0x88BD	1 word	Internal Register 61 Value (Working)
435007	0x88BE	1 word	Internal Register 62 Value (Working)
435008	0x88BF	1 word	Internal Register 63 Value (Working)
435009	0x88C0	1 word	Internal Register 64 Value (Working)
435010	0x88C1	1 word	Internal Register 65 Value (Working)
435011	0x88C2	1 word	Internal Register 66 Value (Working)
435012	0x88C3	1 word	Internal Register 67 Value (Working)
435013	0x88C4	1 word	Internal Register 68 Value (Working)
435014	0x88C5	1 word	Internal Register 69 Value (Working)
435015	0x88C6	1 word	Internal Register 70 Value (Working)
435016	0x88C7	1 word	Internal Register 71 Value (Working)
435017	0x88C8	1 word	Internal Register 72 Value (Working)
435018	0x88C9	1 word	Internal Register 73 Value (Working)
435019	0x88CA	1 word	Internal Register 74 Value (Working)
435020	0x88CB	1 word	Internal Register 75 Value (Working)
435021	0x88CC	1 word	Internal Register 76 Value (Working)
435022	0x88CD	1 word	Internal Register 77 Value (Working)
435023	0x88CE	1 word	Internal Register 78 Value (Working)
435024	0x88CF	1 word	Internal Register 79 Value (Working)

I/O Image Map Addressing

Modular ioAdmin allocates I/O channels into four groups.

1. **DI:** Modbus input coil map (read-only)
2. **DO:** Modbus coil map (read/write)
3. **AI:** Modbus input register map (read-only)
4. **AO:** Modbus holding register map (read/write)

There are two ways to arrange the I/O image Map, which is set on the Adaptor Settings Tab.

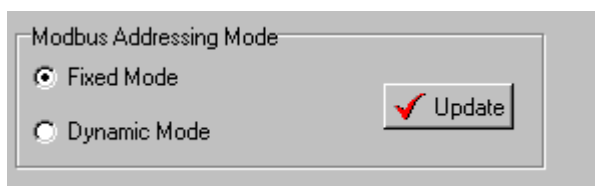

1. **Fixed mode (Default):** Every slot has its own memory bank. This is easy way to understand, but is less efficient due to the fact that a larger memory size is required.
2. **Dynamic mode:** Modular ioAdmin will try to group the same type of input/output channels together to reduce memory size and increase efficiency.

NOTE You can easily find the Modbus address with the Modular ioAdmin utility. After clicking the I/O Configuration tab, select the I/O modules, and then click the **Modbus Address** tab.

Note that you can right click the selected ioLogik E4200 in the Modular ioAdmin utility to export the Modbus address table to a CSV (Microsoft Excel) file.

Fixed mode (default mode):

Modular ioAdmin allocates 512 memory address sizes based on each I/O module's sequence in the I/O system. Slot 0 will range from 0x0000 to 0x01FF and slot 1 will range from 0x0200 to 0x03FF. For example:

If the M-3402 is in position 5 (the 6th slot), then

Channel-0: $(0x0200 * 5 + 0) = 0x0A00$ (input register map)

Channel-1: $(0x0200 * 5 + 1) = 0x0A01$ (input register map)

Channel-2: $(0x0200 * 5 + 2) = 0x0A02$ (input register map)

Channel-3: $(0x0200 * 5 + 3) = 0x0A03$ (input register map)

If the M-4202 is in position 0 (the 1st slot), then

Channel-0: $(0x0200 * 0 + 0) = 0x0000$ (holding register map)

Channel-1: $(0x0200 * 0 + 1) = 0x0001$ (holding register map)

Dynamic Mode

To improve the fragmented memory size and increase performance efficiency, dynamic mode forces Modular ioAdmin to arrange the same I/O types together, without memory holes. If you have developed your own program, you can use it to continually retrieve I/O status. The starting memory address is 0x0000. For example:

If M-2800 (8 channel DO) is in position 0 (the 1st slot), then

Channel-0: 0x0000 (coil map)

Channel-1: 0x0001 (coil map)

Channel-8: 0x0007 (coil map)

If the 1st M-3402 (a 4 channel AI) is in position 2 (the 3rd slot), then

Channel-0: 0x0000 (input register map)

Channel-1: 0x0001 (input register map)

Channel-2: 0x0002 (input register map)

Channel-3: 0x0003 (input register map)

If the 2nd M-3402 (a 4 channel AI) is in position 4 (the 5th slot), then

Channel-0: 0x0004 (input register map)

Channel-1: 0x0005 (input register map)

Channel-2: 0x0006 (input register map)

Channel-3: 0x0007 (input register map)

If M-2801 (an 8 channel DO) is in position 3 (the 4th slot), then

Channel-0: 0x0008 (coil map)

Channel-1: 0x0009 (coil map)

Channel-2: 0x000A (coil map)

Channel-3: 0x000B (coil map)

Channel-4: 0x000C (coil map)

Channel-5: 0x000D (coil map)

Channel-6: 0x000E (coil map)

Channel-7: 0x000F (coil map)

Module Configuration Map

The module configuration map is defined in Fixed mode, starting from 0x3000. Each module occupies a 0x200 (512) address. For example:

1. If there is one module in position 0 (the 1st Slot), its module configuration address will start from $(0x3000+0x200*0) = 12288$
2. If there is one module in position 1 (the 2nd Slot), its module configuration address will start from $(0x3000+0x200*1) = 12800$
3. If there is one module in position 2 (the 3rd Slot), its module configuration address will start from $(0x3000+0x200*2) = 13312$

DO Module Configuration Map

Note: **N** = the number of channels.

Input Register Map (R)

Addrss offset	Access	Word	Description
0x0000	Read-only	1	Moxa code, (If M-2801, the value is 0x2801)
0x0001 to 0x0002	Read-only	2	Reserved
0x0003	Read-only	1	Number of channels
0x0004	Read-only	1	Channel occupied list. (bit-wise)
0x0005	Read-only	1	Firmware version

Holding Register Map (R/W)

Addrss offset	Access	Word	Description
0x0000 to 8N-1	R/W	N*8	Channel alias name (Alias Name is 8 word)
8N to 16N-1	R/W	N*8	Alias for ON status (Alias Name is 8 word)
16N to 24N-1	R/W	N*8	Alias for OFF status (Alias Name is 8 word)

Coil Map (R/W)

Addrss offset	Access	Bit	Description
0x0000 to N-1	R/W	N	Safe mode action (0: fault value, 1: hold last state)
N to 2N-1	R/W	N	Fault value
2N to 3N-1	R/W	N	Power-on status

DI Module Configuration Map:

Note: **N** = then number of channels.

Input Register Map(R)

Addrss offset	Access	Word	Description
0x0000	Read-only	1	Moxa code, (If M-2801, the value is 0x2801)
0x0001 to 0x0002	Read-only	2	Reserved
0x0003	Read-only	1	Number of channels
0x0004	Read-only	1	Channel occupied list. (bit-wise)
0x0005	Read-only	1	Firmware version

Holding Register Map(R/W)

Addrss offset	Access	Word	Description
0x0000 to 8N-1	R/W	N*8	Channel alias name (Alias Name is 8 word)
8N to 16N-1	R/W	N*8	Alias for ON status (Alias Name is 8 word)
16N to 24N-1	R/W	N*8	Alias for OFF status (Alias Name is 8 word)

AO Module Configuration Map

Note: **N** = then number of channels.

Input Register Map (R)

Addrss offset	Access	Word	Description
0x0000	Read-only	1	Moxa code, (If M-2801, the value is 0x2801)
0x0001 to 0x0002	Read-only	2	Reserved
0x0003	Read-only	1	Number of channels
0x0004	Read-only	1	Channel occupied list. (bit-wise)
0x0005	Read-only	1	Firmware version

Holding Register Map (R/W)

Addrss offset	Access	Word	Description
0x0000 to 8N-1	R/W	N*8	Channel alias name (Alias Name is 8 word)
8N to 9N-1	R/W	N	Fault action (Each channel 1 word)
9N to 10N-1	R/W	N	00: fault value, 01: hold last value
10N to 11N-1	R/W	N	10: low limit, 11: high limit

AI Module Configuration Map

Note: **N** = then number of channels.

Input Register Map (R)

Addrss offset	Access	Word	Description
0x0000	Read-only	1	Moxa code, (If M-2801, the value is 0x2801)
0x0001 to 0x0002	Read-only	2	Reserved
0x0003	Read-only	1	Number of channels
0x0004	Read-only	1	Channel occupied list. (bit-wise)
0x0005	Read-only	1	Firmware version

Holding Register Map (R/W)

Addrss offset	Access	Word	Description
0x0000 to 8N-1	R/W	N*8	Channel alias name (Alias Name is 8 word)
8N to 16N-1	R/W	N*8	Reserved

TC Module Configuration Map:

Note: **N** = then number of channels.

Input Register Map (R)

Addrss offset	Access	Word	Description
0x0000	Read-only	1	Moxa code, (If M-2801, the value is 0x2801)
0x0001 to 0x0002	Read-only	2	Reserved
0x0003	Read-only	1	Number of channels
0x0004	Read-only	1	Channel occupied list. (bit-wise)
0x0005	Read-only	1	Firmware version
0x0006	Read-only	1	CJC value

Holding Register Map (R/W)

Addrss offset	Access	Word	Description
0x0000 to 8N-1	R/W	N*8	Channel alias name (Alias Name is 8 word)
8N to 16N-1	R/W	N*8	Reserved
16N	R/W	1	Sensor type
16N+1	R/W	1	Temperature type
16N+2	R/W	1	Enable/Disable Filter (0: Normal, 1: Enhanced)
16N+3	R/W	1	Enable/Disable CJC (0: on, 1: off)
16N+4	R	1	Reserved

RTD Module Configuration Map

Note: **N** = then number of channels.

Input Register Map (R)

Addrss offset	Access	Word	Description
0x0000	Read-only	1	Moxa code, (If M-2801, the value is 0x2801)
0x0001 to 0x0002	Read-only	2	Reserved
0x0003	Read-only	1	Number of channels
0x0004	Read-only	1	Channel occupied list. (bit-wise)
0x0005	Read-only	1	Firmware version

Holding Register Map (R/W)

Addrss offset	Access	Word	Description
0x0000 to 8N-1	R/W	N*8	Channel alias name (Alias Name is 8 word)
8N to 16N-1	R/W	N*8	Reserved
16N	R/W	1	Sensor type
16N+1	R/W	1	Temperature type
16N+2	R/W	1	Enable/Disable Filter (0:normal, 1:enchanced)

Internal Registers

Refer to the exported Modbus address file for details.

Function 8

Sub-function	Data Field (Request)	Data Field (Response)	Description
0x0001	0x0000	Echo Request Data	Reboot
0x0001	0xFF00	Echo Request Data	Reset with Factory default

CGI Commands

Using a web browser or standard HTTP protocol makes it easier for a Security SCADA system to monitor and control an ioLogik via CGI commands.

To get all the syntax of the CGI Commands on line, open a web browser and connect to the ioLogik E4200 using the following syntax. Replace **IP** with the IP address of the target ioLogik E4200.

<http://IP/Help.cgi>

Use the following syntax to get the settings. Start with the ioLogik's IP or URL followed by **getParam.cgi** and a question mark. Next, specify the command followed by another question mark. The commands are case sensitive, and the **&** (ampersand) symbol is used to combine multiple commands.

[http://IP/getParam.cgi?command_channel=?&command_channel=?&.....\(Max 200 char\)](http://IP/getParam.cgi?command_channel=?&command_channel=?&.....(Max 200 char))

"get" command example	Description
SLOT00CH00_STATUS	Get the slot-0 channel-0 status
SLOT00CH01_STATUS	Get the slot-0 channel-1 status
SLOT00CH02_STATUS	Get the slot-0 channel-2 status
SLOT01CH00_STATUS	Get the slot-1 channel-0 status
SLOT02CH00_STATUS	Get the slot-2 channel-0 status
SLOT03CH00_STATUS	Get the slot-3 channel-0 status
SLOT00_MOXA	Get the slot-0 moxa code
SLOT00_CHANNEL	Get the slot-0 number of channels
NUM_SLOTS	Get the number of modules attached
FWR_V	Get firmware version
SN_NUM	Get system serial number
TIME	Get system time
DATE	Get system date

Use the following syntax to set the parameters. Start with the ioLogik's IP or URL followed by **setParam.cgi** and a question mark. Next, specify the command followed by another question mark. The commands are case sensitive, and the **&** (ampersand) symbol is used to combine multiple commands.

[http://IP/setParam.cgi?command_channel=?&command_channel=?&.....\(Max 200 char\)](http://IP/setParam.cgi?command_channel=?&command_channel=?&.....(Max 200 char))

"set" command example	Description
SLOT00CH00_STATUS=1	Set the slot-0 channel-0 output raw data 1(unsigned decimal)
SLOT00CH01_STATUS=50	Set the slot-1 channel-2 output raw data 50(unsigned decimal)

D

Network Port Numbers

E4200 Network Port Usage:

Port	Type	Usage
80	TCP	Web Server
502	TCP	Modbus Communication
161	TCP	SNMP
68	UDP	BOOTPC
68	UDP	DHCP
4801	UDP	Auto search
4040	TCP	ioEventLog
9001	TCP	Active Message
9900	TCP	Active Tags updates (default)

SNMP MIB File

The ioLogik E4200 has SNMP (Simple Network Management Protocol) agent software built in. The software supports SNMP traps, RFC1317 RS-232-like groups, and RFC 1213 MIB-II. The following table lists the standard MIB-II groups, as well as how the variables are implemented for the ioLogik E4200.

- ❑ **RFC1213 MIB-II supported SNMP variables:**
- ❑ **Private MIB File and SNMP Variables**

RFC1213 MIB-II supported SNMP variables:

System MIB	Interfaces MIB	IP MIB	ICMP MIB
SysDescr	ifNumber	ipForwarding	IcmpInMsgs
SysObjectID	ifIndex	ipDefaultTTL	IcmpInErrors
SysUpTime	ifDescr	ipInreceives	IcmpInDestUnreachs
SysContact	ifType	ipInHdrErrors	IcmpInTimeExcds
SysName	ifMtu	ipInAddrErrors	IcmpInParmProbs
SysLocation	ifSpeed	ipForwDatagrams	IcmpInSrcQuenchs
SysServices	ifPhysAddress	ipInUnknownProtos	IcmpInRedirects
	ifAdminStatus	ipInDiscards	IcmpInEchos
	ifOperStatus	ipInDelivers	IcmpInEchoReps
	ifLastChange	ipOutRequests	IcmpInTimestamps
	ifInOctets	ipOutDiscards	IcmpTimestampReps
	ifInUcastPkts	ipOutNoRoutes	IcmpInAddrMasks
	ifInNUcastPkts	ipReasmTimeout	IcmpOutMsgs
	ifInDiscards	ipReasmReqds	IcmpOutErrors
	ifInErrors	ipReasmOKs	IcmpOutDestUnreachs
	ifInUnknownProtos	ipReasmFails	IcmpOutTimeExcds
	ifOutOctets	ipFragOKs	IcmpOutParmProbs
	ifOutUcastPkts	ipFragFails	IcmpOutSrcQuenchs
	ifOutNUcastPkts	ipFragCreates	IcmpOutRedirects
	ifOutDiscards	ipAdEntAddr	IcmpOutEchos
	ifOutErrors	ipAdEntIfIndex	IcmpOutEchoReps
	ifOutQLen	ipAdEntNetMask	IcmpOutTimestamps
	ifSpecific	ipAdEntBcastAddr	IcmpOutTimestampReps
		ipAdEntReasmMaxSize	IcmpOutAddrMasks
		ipRouteDest	IcmpOutAddrMaskReps
		ipRouteIfIndex	
		ipRouteMetric1	
		ipRouteMetric2	
		ipRouteMetric3	
		ipRouteMetric4	
		ipRouteNextHop	
		ipRouteType	
		ipRouteProto	
		ipRouteAge	
		ipRouteMask	
		ipRouteMetric5	
		ipRouteInfo	
		IpNetToMediaIfIndex	
		IpNetToMediaPhysAddress	
		IpNetToMediaNetAddress	
		IpNetToMediaType	
		IpRoutingDiscards	

UDP MIB	TCP MIB	SNMP MIB
UdpInDatagrams	tcpRtoAlgorithm	snmpInPkts
UdpNoPorts	tcpRtoMin	snmpOutPkts
UdpInErrors	tcpRtoMax	snmpInBadVersions
UdpOutDatagrams	tcpMaxConn	snmpInBadCommunityNames
UdpLocalAddress	tcpActiveOpens	snmpInBadCommunityUses
UdpLocalPort	tcpPassiveOpens	snmpInASNParseErrs
	tcpAttemptFails	snmpInTooBigs
	tcpEstabResets	snmpInNoSuchNames
Address Translation MIB	tcpCurrEstab	snmpInBadValues
AtIfIndex	tcpInSegs	snmpInReadOnlys
AtPhysAddress	tcpOutSegs	snmpInGenErrs
AtNetAddress	tcpRetransSegs	snmpInTotalReqVars
AtNetAddress	tcpConnState	snmpInTotalSetVars
	tcpConnLocalAddress	snmpInGetRequests
	tcpConnLocalPort	snmpInGetNexts
	tcpConnRemAddress	snmpInSetRequests
	tcpConnRemPort	snmpInGetResponses
	tcpInErrs	snmpInTraps
	tcpOutRsts	snmpOutTooBigs
		snmpOutNoSuchNames
		snmpOutBadValues
		snmpOutGenErrs
		snmpOutGetRequests
		snmpOutGetNexts
		snmpOutSetRequests
		snmpOutGetResponses
		snmpOutTraps
		snmpEnableAuthenTraps

Private MIB File and SNMP Variables

Moxa also provides an SNMP for the I/O MIB file to help you monitor I/O status with SNMP software. You can find the MIB file from Moxa's website.

Moxa Modular IO MIB

moduleName0	moduleName1	moduleName2
ioType0	ioType1	ioType2
numberOfChannels0	numberOfChannels1	numberOfChannels2
ioRange0	ioRange1	ioRange2
temperatureType0	temperatureType1	temperatureType2
sensorType0	sensorType1	sensorType2
cjcSwitch0	cjcSwitch1	cjcSwitch2
output-0-index	output-1-index	output-2-index
output-0-status	output-1-status	output-2-status
output-0-power-on-status	output-1-power-on-status	output-2-power-on-status
output-0-safe-action	output-1-safe-action	output-2-safe-action
output-0-fault-value	output-1-fault-value	output-2-fault-value
input-0-index	input-1-index	input-2-index
input-0-status	input-1-status	input-2-status

moduleName3	moduleName4	moduleName5
ioType3	ioType4	ioType5
numberOfChannels3	numberOfChannels4	numberOfChannels5
ioRange3	ioRange4	ioRange5
temperatureType3	temperatureType4	temperatureType5
sensorType3	sensorType4	sensorType5
cjcSwitch3	cjcSwitch4	cjcSwitch5
output-3-index	output-4-index	output-5-index
output-3-status	output-4-status	output-5-status
output-3-power-on-status	output-4-power-on-status	output-5-power-on-status
output-3-safe-action	output-4-safe-action	output-5-safe-action
output-3-fault-value	output-4-fault-value	output-5-fault-value
input-3-index	input-4-index	input-5-index
input-3-status	input-4-status	input-5-status

moduleName6	moduleName7	moduleName8
ioType6	ioType7	ioType8
numberOfChannels6	numberOfChannels7	numberOfChannels8
ioRange6	ioRange7	ioRange8
temperatureType6	temperatureType7	temperatureType8
sensorType6	sensorType7	sensorType8
cjcSwitch6	cjcSwitch7	cjcSwitch8
output-6-index	output-7-index	output-8-index
output-6-status	output-7-status	output-8-status
output-6-power-on-status	output-7-power-on-status	output-8-power-on-status
output-6-safe-action	output-7-safe-action	output-8-safe-action
output-6-fault-value	output-7-fault-value	output-8-fault-value
input-6-index	input-7-index	input-8-index
input-6-status	input-7-status	input-8-status

moduleName9	moduleName10	moduleName11
ioType9	ioType10	ioType11
numberOfChannels9	numberOfChannels10	numberOfChannels11
ioRange9	ioRange10	ioRange11
temperatureType9	temperatureType10	temperatureType11
sensorType9	sensorType10	sensorType11
cjcSwitch9	cjcSwitch10	cjcSwitch11
output-9-index	output-10-index	output-11-index
output-9-status	output-10-status	output-11-status
output-9-power-on-status	output-10-power-on-status	output-11-power-on-status
output-9-safe-action	output-10-safe-action	output-11-safe-action
output-9-fault-value	output-10-fault-value	output-11-fault-value
input-9-index	input-10-index	input-11-index
input-9-status	input-10-status	input-11-status

moduleName12	moduleName13	moduleName14
ioType12	ioType13	ioType14
numberOfChannels12	numberOfChannels13	numberOfChannels14
ioRange12	ioRange13	ioRange14
temperatureType12	temperatureType13	temperatureType14
sensorType12	sensorType13	sensorType14
cjcSwitch12	cjcSwitch13	cjcSwitch14
output-12-index	output-13-index	output-14-index
output-12-status	output-13-status	output-14-status
output-12-power-on-status	output-13-power-on-status	output-14-power-on-status
output-12-safe-action	output-13-safe-action	output-14-safe-action
output-12-fault-value	output-13-fault-value	output-14-fault-value
input-12-index	input-13-index	input-14-index
input-12-status	input-13-status	input-14-status

moduleName15		
ioType15		
numberOfChannels15		
ioRange15		
temperatureType15		
sensorType15		
cjcSwitch15		
output-15-index		
output-15-status		
output-15-power-on-status		
output-15-safe-action		
output-15-fault-value		
input-15-index		
input-15-status		

Factory Default Settings

The ioLogik E4200 is configured with the following default private IP addresses:

LAN-0 Default IP address:	192.168.127.254
LAN-0 Default Netmask:	255.255.255.0
LAN-0 Default Gateway:	0.0.0.0 (None)
LAN-1 Default IP address:	192.168.126.254
LAN-1 Default Netmask:	255.255.255.0
LAN-1 Default Gateway:	0.0.0.0 (None)
IP Filter:	Disable
Time Zone	23 (Greenwich)
Time server:	None
Communication watchdog	Disable
Watchdog Timeout:	60 secs
Password:	empty
Module Name:	empty
Module Location:	empty
Web Console:	Enable
SNMP:	Enable
Read Community:	"public"
Write Community:	"private"
Contact:	empty
Location:	empty
Modbus Addressing Mode:	Fixed mode
Click&Go Power-on Status:	Stop
DO Power-on Status:	Off
AO Power-on Status:	0x0000
TC Power-on sensor type:	K-Type
TC Power-on CJC:	Enable
RTD Power-on sensor type:	PT100
TC/RTD Power-on Temperature Type:	Celsius
DO Safe Action:	Fault value
DO Fault value:	Off
AO Safe Action:	Fault value
AO Fault value:	0x0000
Alias name of DO:	"DO"
Alias name of DI:	"DI"
Alias name of AO:	"AO"
Alias name of AI:	"AI"
Alias name of TC:	"TC"
Alias name of RTD:	"RTD"

FCC Statement

This device complies with part 15 of the FCC Rules. Operation is subject to the following two conditions: (1) This device may not cause harmful interference, and (2) this device must accept any interference received, including interference that may cause undesired operation.

FCC Warning!

This equipment has been tested and found to comply with the limits for a Class A digital device, pursuant to part 15 of the FCC Rules. These limits are designed to provide reasonable protection against harmful interference when the equipment is operated in a commercial environment. This equipment generates, uses, and can radiate radio frequency energy and, if not installed and used in accordance with the instruction manual, may cause harmful interference to radio communications. Operation of this equipment in a residential area is likely to cause harmful interference in which case the user will be required to correct the interference at his own expense.



ATTENTION

Installation and Cabling Precautions

- Check the rated voltage and current for the products before wiring.
- Use the rated power supply and specified cables. Using the wrong power supply could cause a fire.
- Cabling should be done by a certified electrician according to the Electricity Engineering Regulations.
- Improper cabling could cause a fire, or electric shock.

Operating Precautions

- Do not touch the terminal when the power is on to avoid electric shock
- Do not assemble the product when the power is on.
- Do not modify the wiring while operating the product.
- Pay attention to the power linkage procedure. An incorrect process flow could lead to mechanical damage or other hazards.