

# GMT Series G01/G02

## User Manual v1.0.0



## Table of Contents

Chapter1. Overview .....	1
1.1. Specification .....	1
1.2. Dimensions.....	2
1.3. Connector pin designations .....	4
1.4. Restoring factory default .....	4
1.5. LED indicator .....	5
1.6. Battery.....	6
1.7. Power connection .....	6
Chapter2. cMT-G01/G02 System Setting .....	7
2.1. Search for cMT-G01/G02's IP address .....	7
2.2. Set in internet browser .....	7
2.3. System Setting.....	8
2.3.1. Network .....	8
2.3.2. Wi-Fi (cMT-G02).....	9
2.3.3. Date/Time .....	9
2.3.4. HMI Name.....	10
2.3.5. History.....	10
2.3.6. Email .....	11
2.3.7. Project Management .....	12
2.3.8. System Password .....	12
2.3.9. Enhanced Security .....	13
2.3.10. EasyAccess 2.0 .....	13
2.3.11. OPA UA .....	14
2.3.12. Communication .....	14
Chapter3. Updating Web Package and OS .....	15
3.1 Updating Web Package .....	15
3.2 Updating OS .....	16
Chapter4. How to create a cMT-G01/G02 project .....	18
4.1. Create a new project.....	18
4.2. Download project to cMT-G01/G02 .....	20
4.3. Monitoring OPC UA Client.....	21
4.4. On-line/Off-line Simulation.....	21
Chapter5. Functions supported by cMT-G01/G02 .....	23
Chapter6. OPC UA Web Management Interface .....	24
6.1. Introduction .....	24
6.2. Startup / Shut Down .....	25
6.3. Server Settings .....	25

- 6.4. Edit Node..... 27
- 6.5. Certificates ..... 28
- 6.6. Discovery..... 29
- 6.7. Advanced..... 30

## Chapter1. Overview

### 1.1. Specification



#### IIoT Gateway

##### Features

- Supports OPC UA
- Supports MQTT
- Supports MODBUS TCP/IP Gateway
- Compact Design and DIN-rail Mountable
- Fan-less Cooling System
- Built-in 256 MB Flash Memory
- Supports MPI 187.5K
- Built-in Power Isolator
- cMT-G02 supports Wi-Fi

Model		cMT-G01	cMT-G02	
Memory	Flash	256 MB		
	RAM	256 MB		
Processor		32 bits RISC Cortex-A8 600MHz		
I/O Port	SD Card Slot	N/A		
	USB Host	N/A		
	USB Client	N/A		
	Ethernet		10/100/1000 Base-T x 1	WiFi IEEE 802.11 b/g/n
			10/100 Base-T x 1	10/100 Base-T x 1
	COM Port	COM1: RS-232 2W, COM2: RS-485 2W/4W, COM3: RS-485 2W		
	RS-485 Built-in Isolation	N/A		
	CAN Bus	N/A		
	HDMI	N/A		
	Audio Output	N/A		
Video Input	N/A			
RTC		Built-in		
Power	Input Power	24±20%VDC	10.5~28VDC	
	Power Isolation	Built-in		
	Power Consumption	230mA@24VDC	230mA@12VDC; 115mA@24VDC	
	Voltage Resistance	500VAC (1 min.)		
	Isolation Resistance	Exceed 50MΩ at 500VDC		
	Vibration Endurance	10 to 25Hz (X, Y, Z direction 2G 30 minutes)		
Specification	PCB Coating	Yes		
	Enclosure	Plastic		
	Dimensions WxHxD	109 x 81 x 27 mm		
	Weight	Approx. 0.14 kg		
	Mount	35 mm DIN rail mounting		
Environment	Protection Structure	IP20		
	Storage Temperature	-20° ~ 60°C (-4° ~ 140°F)		
	Operating Temperature	0° ~ 50°C (32° ~ 122°F)		
	Relative Humidity	10% ~ 90% (non-condensing)		
Certificate	CE	CE marked		
	UL	cULus Listed	Application in progress	
Software		EasyBuilder Pro V5.06.01	EasyBuilder Pro V6.00.01	

1.2. Dimensions  
cMT-G01

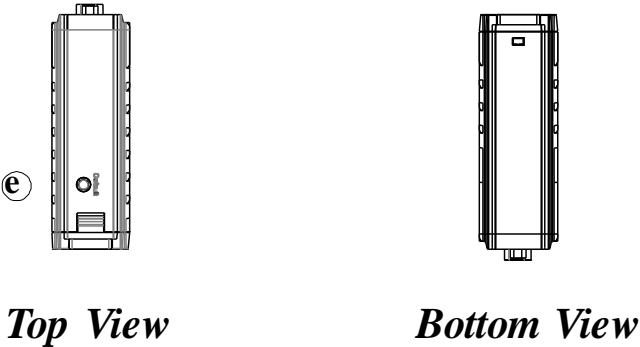
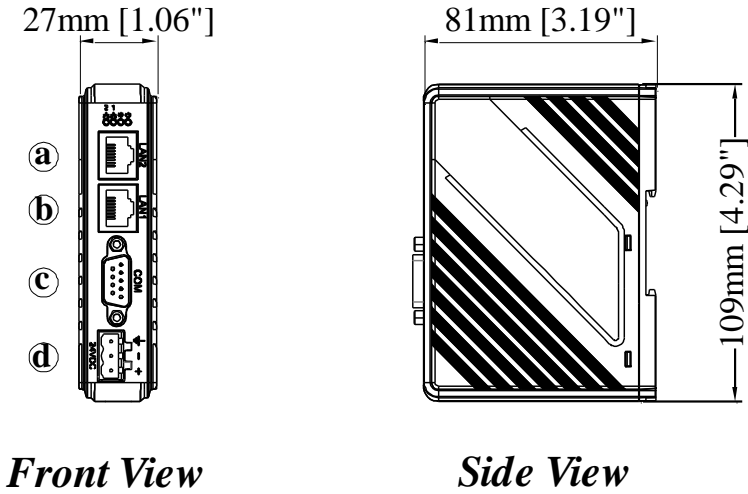

<b>a</b>	LAN 2 Port (10M/100M)
<b>b</b>	LAN 1 Port (10M/100M/1G)
<b>c</b>	COM1: RS-232 2W COM2: RS-485 2W/4W COM3: RS-485 2W
<b>d</b>	Power Connector
<b>e</b>	Default Button

**cMT-G02**

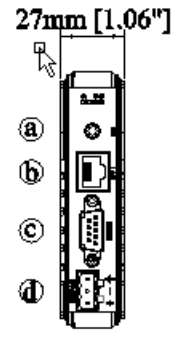

**Front View**

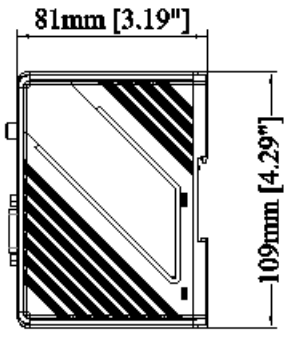

**Side View**

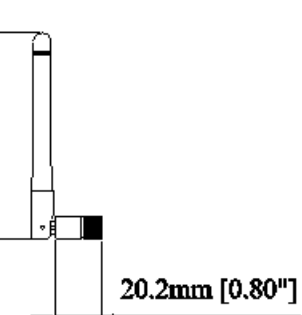
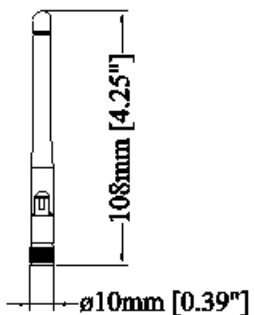

**Antenna**



**Top View**

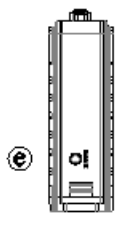

**Bottom View**

<b>a</b>	Wi-Fi
<b>b</b>	LAN 1 Port (10M/100M)
<b>c</b>	COM1: RS-232 2W COM2: RS-485 2W/4W COM3: RS-485 2W
<b>d</b>	Power Connector
<b>e</b>	Default Button

### 1.3. Connector pin designations

COM1 RS-232, COM2 RS-485 2W/4W, COM3 RS-485 2W 9 Pin, Male, D-sub

PIN#	COM1 RS-232	COM2 RS-485		COM3 RS-485
		2W	4W	
1				Data+
2	RxD			
3	TxD			
4				Data-
5	GND			
6		Data+	RX+	
7		Data-	RX-	
8			TX+	
9			TX-	

### 1.4. Restoring factory default

Press and hold on the Default button on the unit for more than 15 seconds to restore factory default.

The IP setting will be restored to default:

cMT-G01:

Ethernet 1: DHCP

Ethernet 2: 192.168.100.1

cMT-G02

Wi-Fi: DHCP

Ethernet: DHCP

Please note that the projects and data stored in the unit are all cleared after pressing the Default button.

### 1.5. LED indicator

LED indicators show the status of IloT Gateway.

cMT-G01



Icon	Color	Meaning
	Blue	LAN 1 Communication Status
	Blue	LAN 2 Communication Status
	Orange	Power Status
	Green	Helps the operator to find the cMT-G01. Triggering system register LB-11959 can turn this indicator on/off. Blink LED function in Web/Download interface can also control this indicator.

cMT-G02



Icon	Color	Meaning
	Blue	LAN Communication Status
	Orange	Power Status
	Green	Helps the operator to find the cMT-G02. Triggering system register LB-11959 can turn this indicator on/off. Blink LED function in Web/Download interface can also control this indicator.

**Note:** The second LED indicator from the left is reserved.



## 1.6. Battery

IIoT Gateway requires a CR1220 lithium battery to keep the RTC running.

## 1.7. Power connection

**Power:** The unit can be powered by DC power only, the voltage range is compatible with most controller DC systems. The power conditioning circuitry inside the unit is accomplished by a switching power supply. The peak starting current can be as high as 500mA.

cMT-G01 voltage range:  $24 \pm 20\%$  VDC

cMT-G02 voltage range: 10.5~28 VDC

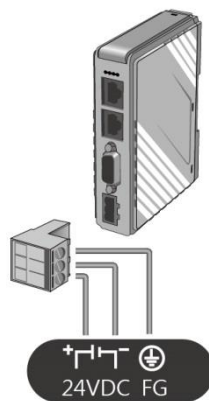

**Note:** Connect positive DC line to the '+' terminal and the DC ground to the '-' terminal.

## Chapter2. cMT-G01/G02 System Setting

Connect cMT-G01/G02 via Ethernet cable, and then configure system settings by using web interface.

### 2.1. Search for cMT-G01/G02's IP address

Launch UtilityManagerEX, select a cMT Series model, and then select a function from Reboot, Download, or Upload. The cMT Series HMI model or cMT-G01/G02 can be found in the IP/HMI Name groupbox by using the model's IP address, even if the PC or laptop is not on the same network. UtilityManagerEX can find and change cMT-G01/G02's IP address. The following settings can be carried out after obtaining the IP address.

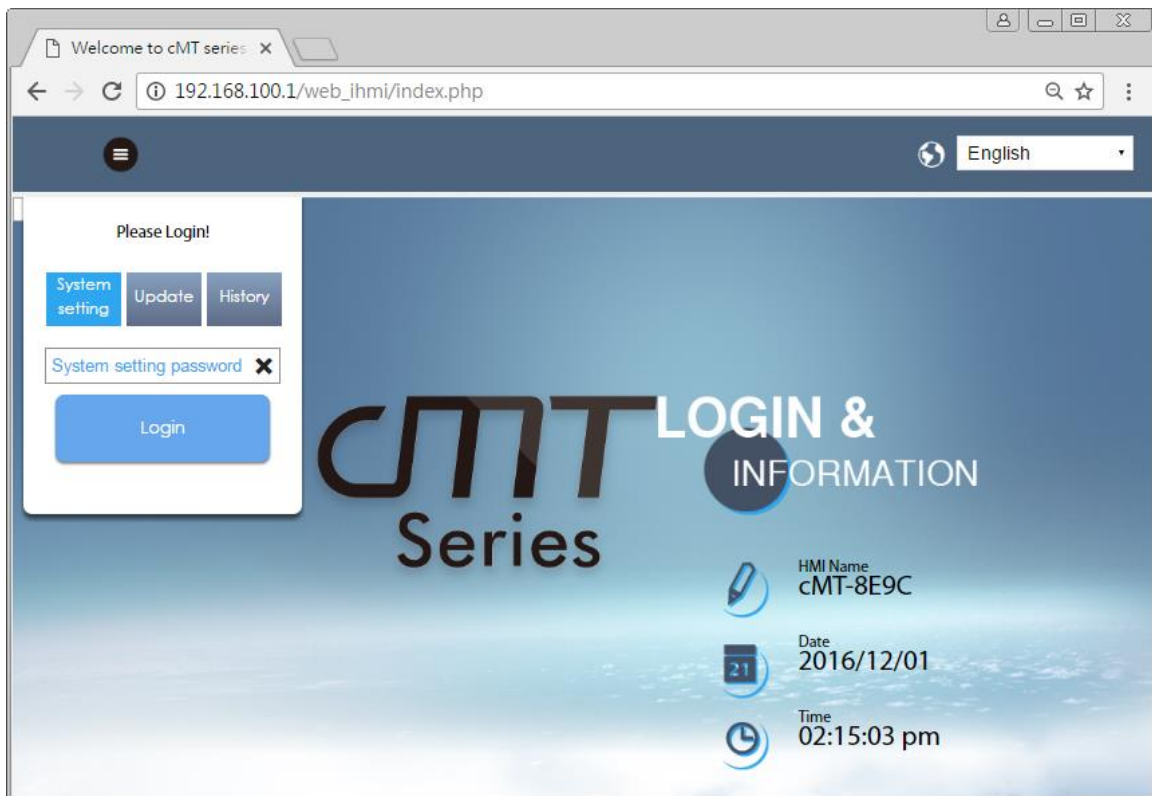

### 2.2. Set in internet browser

Open internet browser (IE, Chrome, or Firefox), and enter cMT-G01/G02's IP address (for example: 192.168.100.1) to configure cMT-G01/G02.



The default IP: Ethernet 1: DHCP, Ethernet 2: 192.168.100.1  
cMT-G01/G02 system information is shown in the Login page.

Icon	Description
	Displays HMI name.

 Date 2016/12/01	Displays system date.
 Time 02:15:17 pm	Displays system time.

### 2.3. System Setting

The following part introduces cMT-G01/G02 system settings.

Please Login!

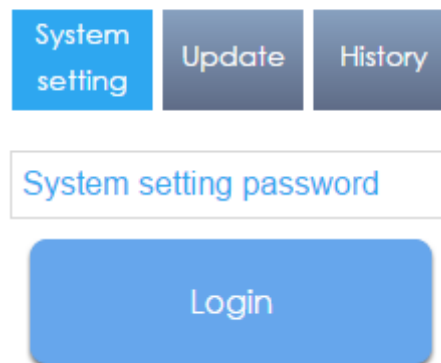

Three levels of privileges can be found:

[System Setting]: Controls all the settings

[Update]: Controls limited items.

[History]: Downloads history data (Recipes and Event Logs).

#### 2.3.1. Network

Configure Ethernet ports: IP, Mask, Gateway, and DNS.

cMT-G01 has two Ethernet ports. The default IP address of Ethernet 1 is DHCP, and the static IP address of Ethernet 2 is 192.168.100.1.

cMT-G02 has one Ethernet port, and is assigned from DHCP by default.

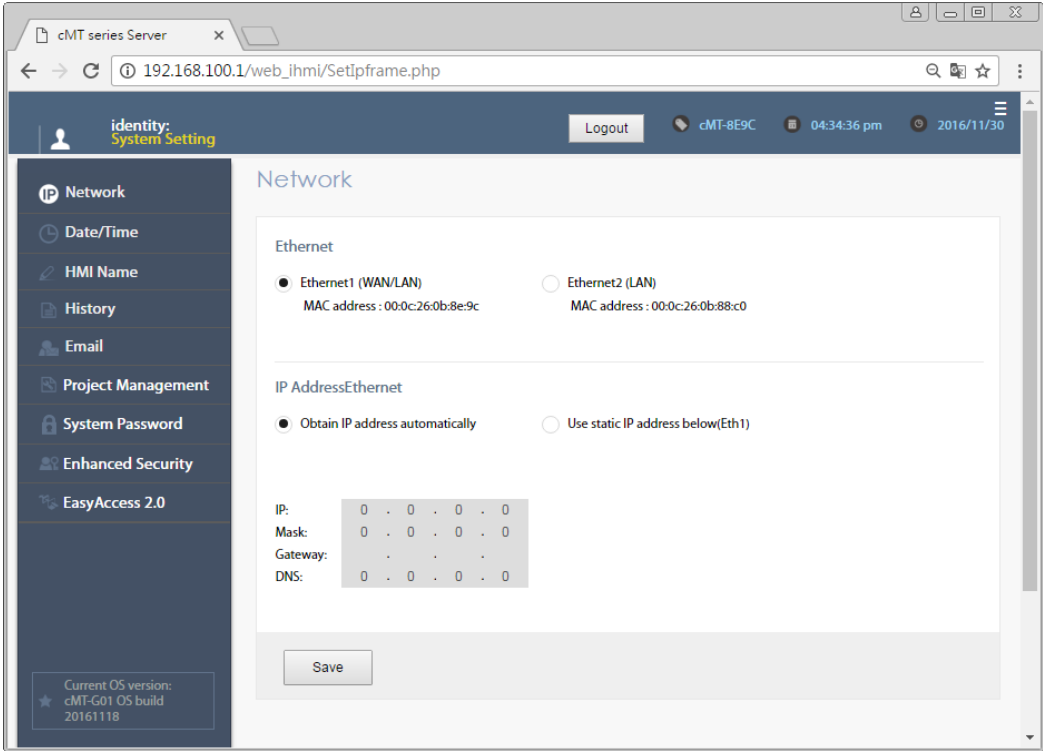

2.3.2. Wi-Fi (cMT-G02)

Enable/Disable Wi-Fi and related settings: search for AP, configuring IP, Mask, Gateway, and DNS.

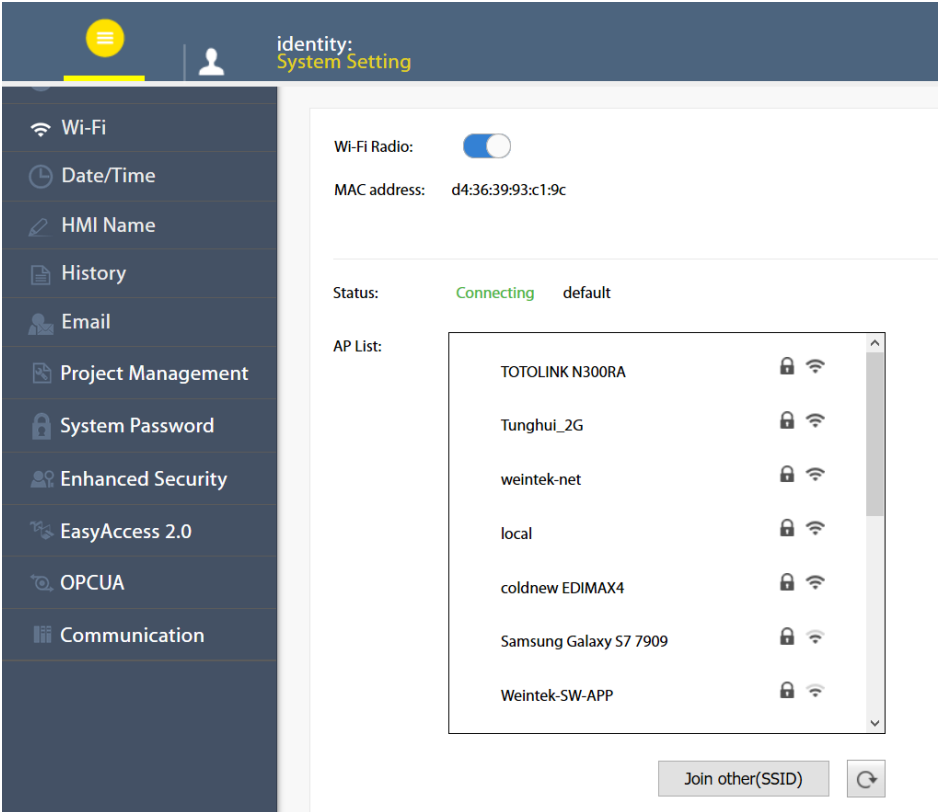

2.3.3. Date/Time

Set RTC date and time. Select [Sync. with host] and then click [Save] to synchronize cMT-G01/G02 time with the computer time.

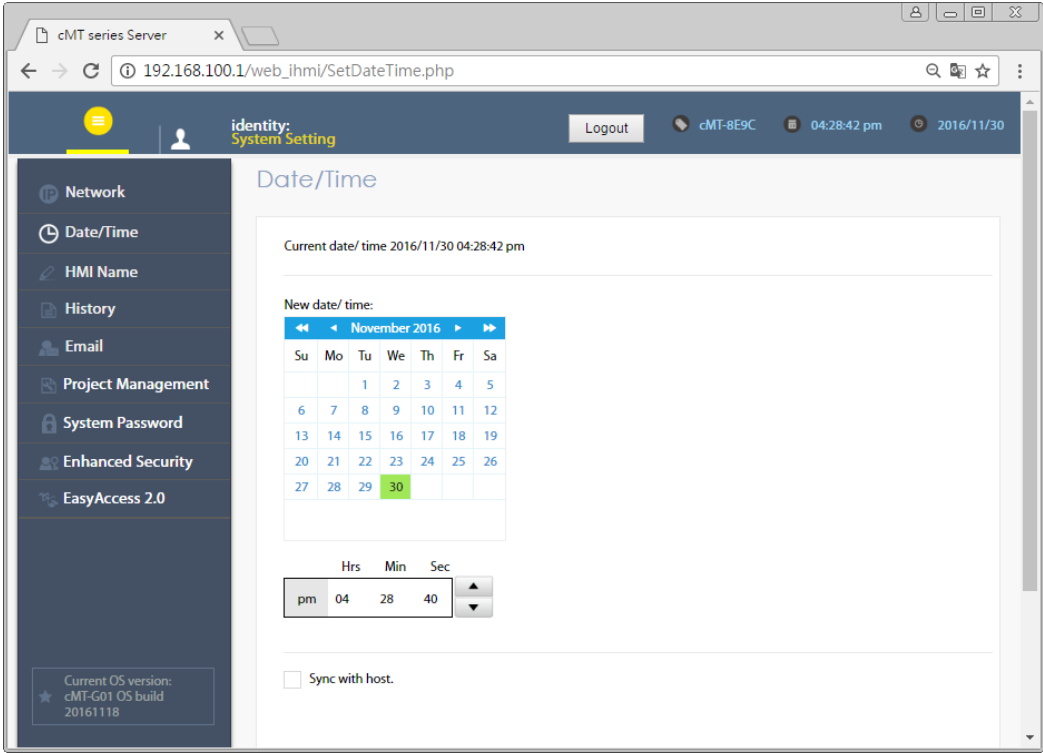

2.3.4. HMI Name

Enter a name to identify the unit.

[Identification light]: The green LED indicator  of the unit will flash three times when this button is clicked, helping user to find the unit.

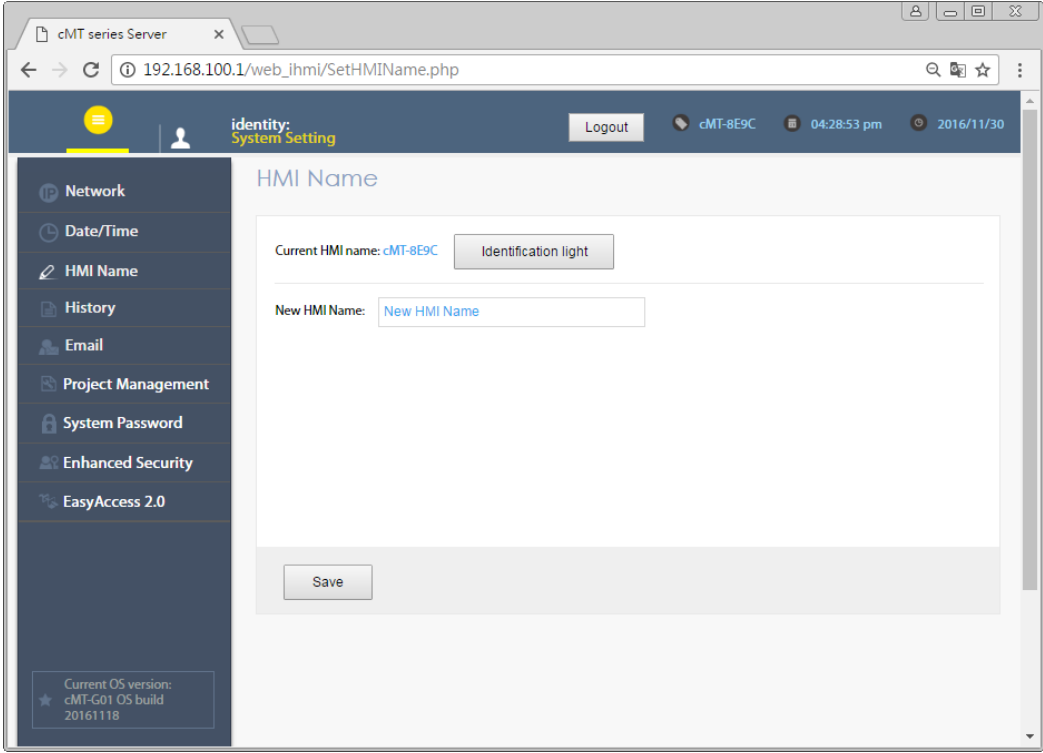

2.3.5. History

This tab offers settings related to historical data.

[Clear]: Clears history data.

[Backup]: Downloads history data in the unit to this computer.

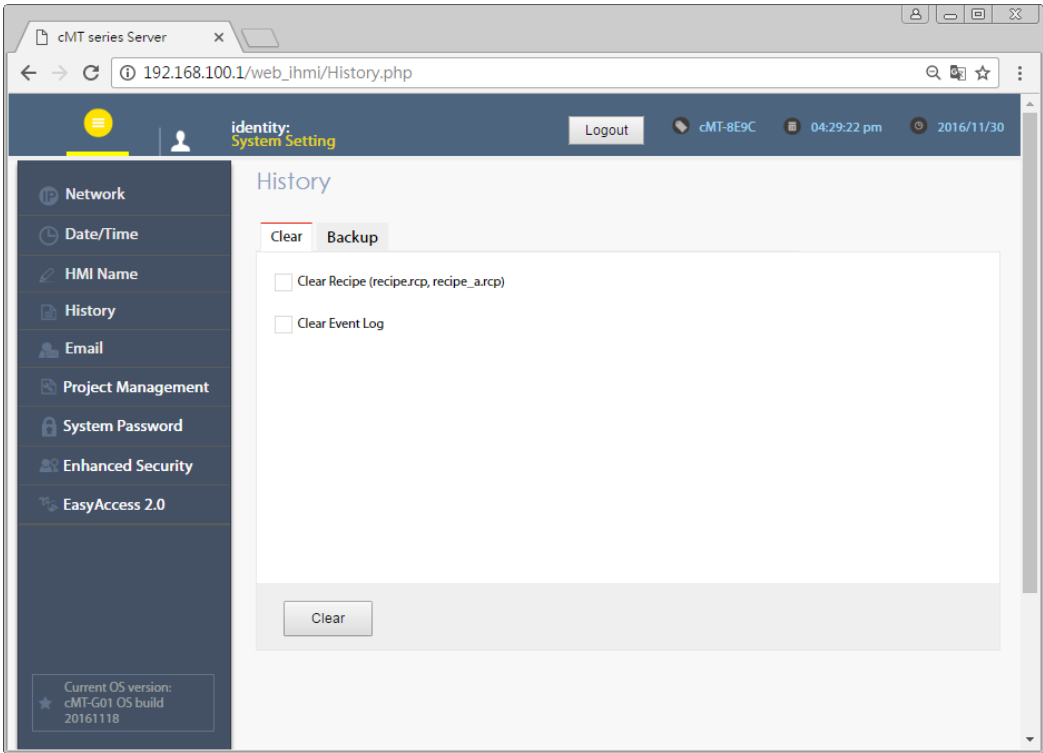

### 2.3.6. Email

This tab offers settings related to email.

[SMTP]: Configure email server and relevant settings.

[Contacts]: Set email contacts in this tab.

[Update Email Contacts]: Import the email contacts built using Administrator Tools.

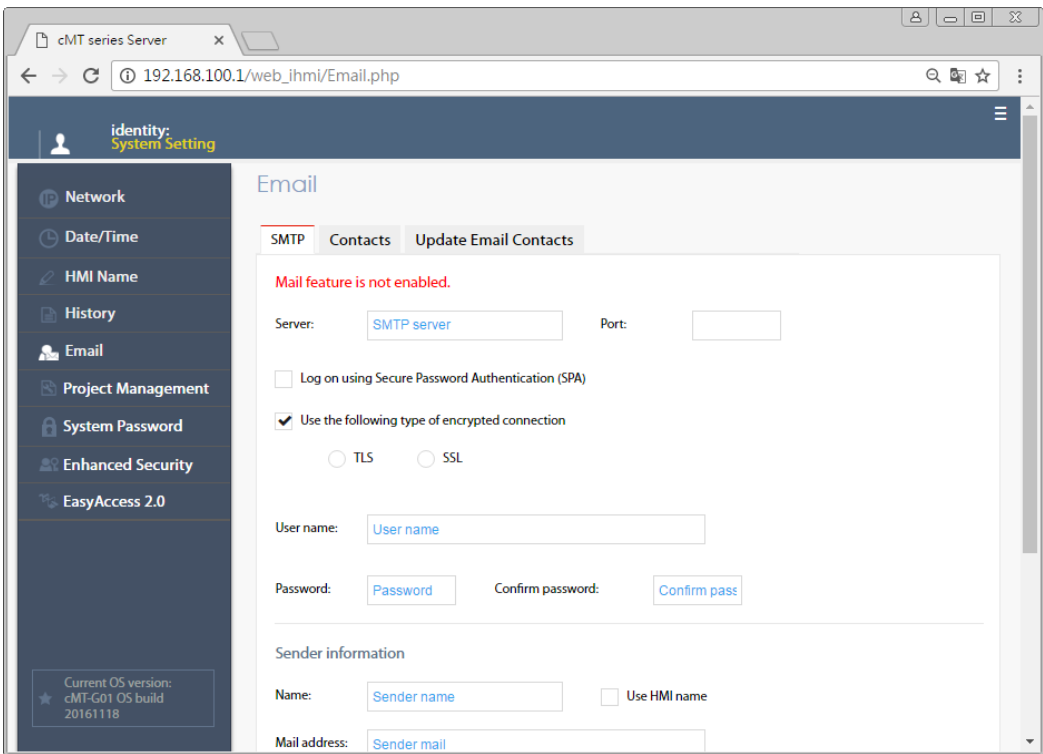

### 2.3.7. Project Management

This tab offers settings related to project management.

[Restart Project]: Restart cMT-G01/G02 project.

[Update Project]: Upload the project's \*.cxob file to cMT-G01/G02.

[Backup Project]: Backup the project file to this computer.

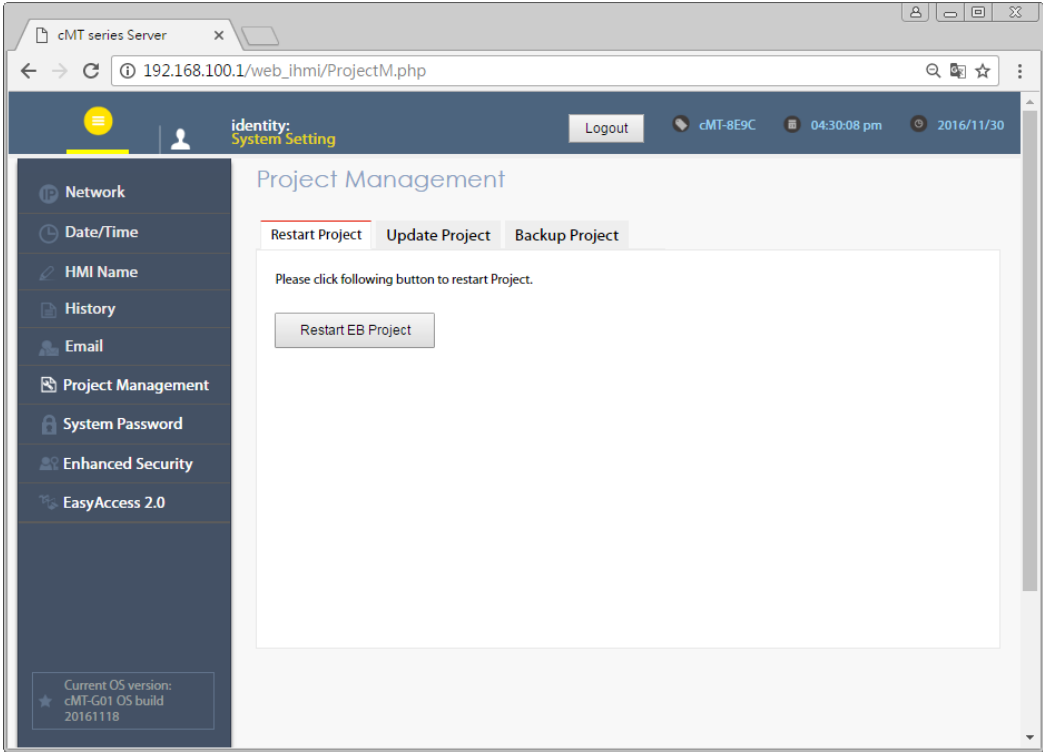

### 2.3.8. System Password

Set login password and the password for transferring project file.

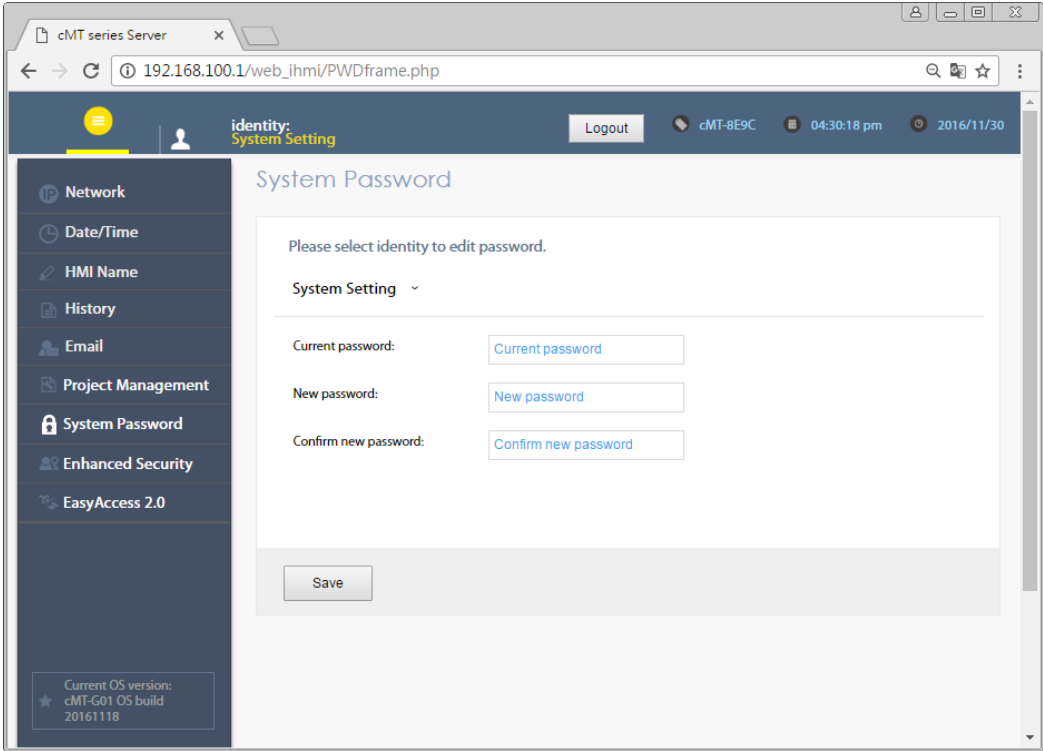

### 2.3.9. Enhanced Security

The account setting in this tab can determine the accounts that can log in OPC UA.

[Accounts]: Add user or change user password and operable classes.

[Import User Account]: Import the user accounts built in Administrator Tools.

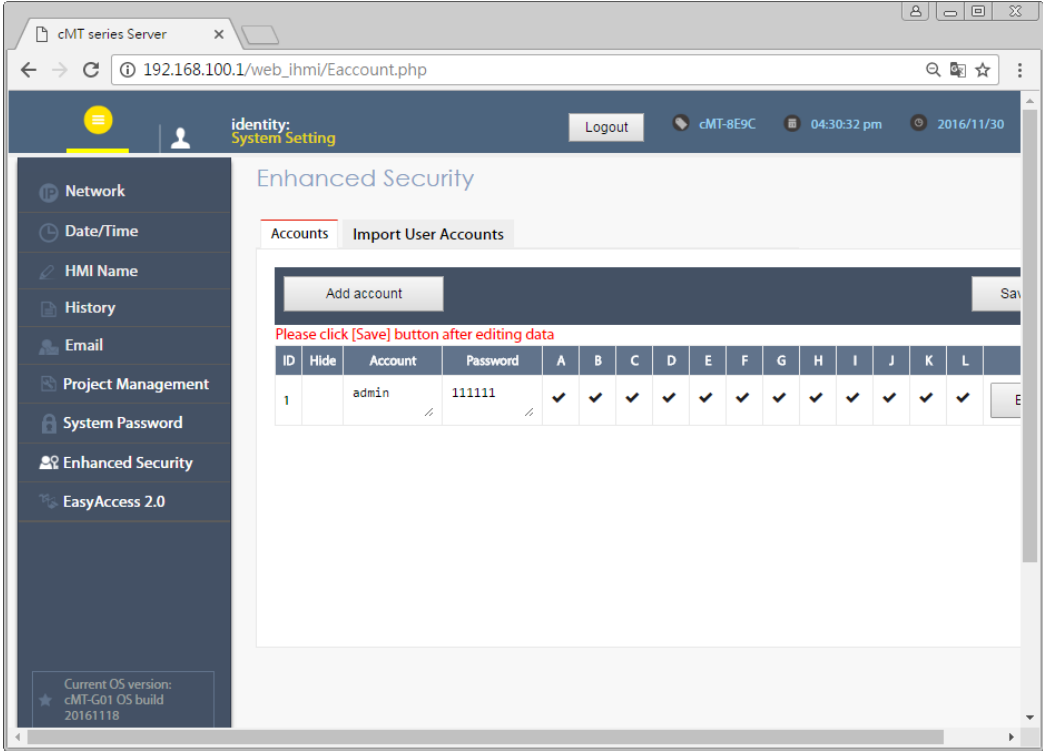

### 2.3.10. EasyAccess 2.0

This tab shows Hardware Key, EasyAccess 2.0 activate status, and proxy settings.

For more information on EasyAccess 2.0, please see EasyAccess 2.0 User Manual.

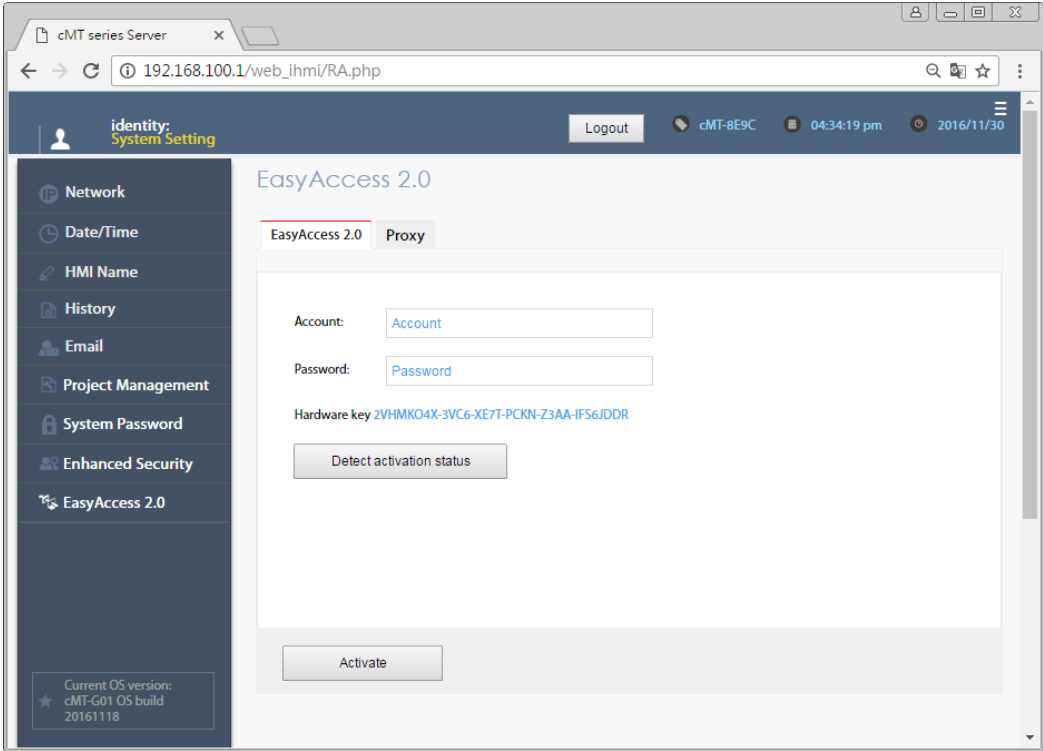



2.3.11. OPA UA

Configure OPC UA settings. Please see Chapter 6 in this manual for more information.

2.3.12. Communication

This tab displays the communication parameters of the device connected to cMT-G01/G02. The parameters can be changed.

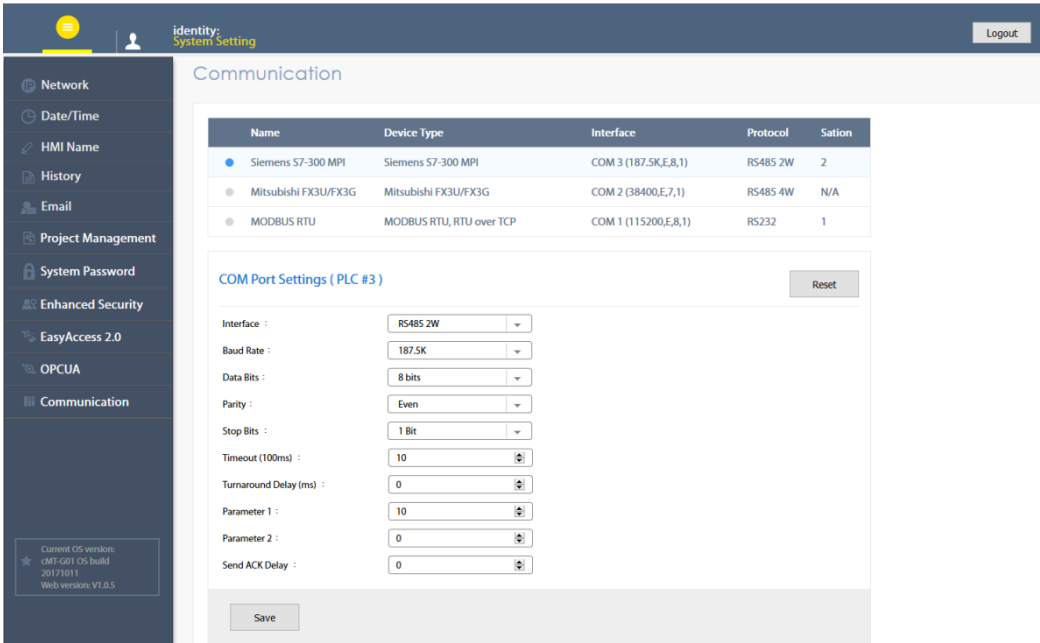

Parameter list for the device connected via Serial Port.

- English
- Interface
- Baud rate
- Data Bits
- Parity
- Stop Bits
- Timeout
- Parameter 1
- Parameter 2
- Send ACK Delay

Parameter list for the device connected via Ethernet Port.

- English
- IP Address
- Port
- Timeout
- Turnaround Delay
- Parameter 1
- Parameter 2
- Send ACK Delay

### Chapter3. Updating Web Package and OS

cMT-G01/G02 Web Package and OS can be updated through Ethernet. Launch Utility ManagerEX, select [cMT Series] » [Maintenance] » [cMT-G01 OS Upgrade].

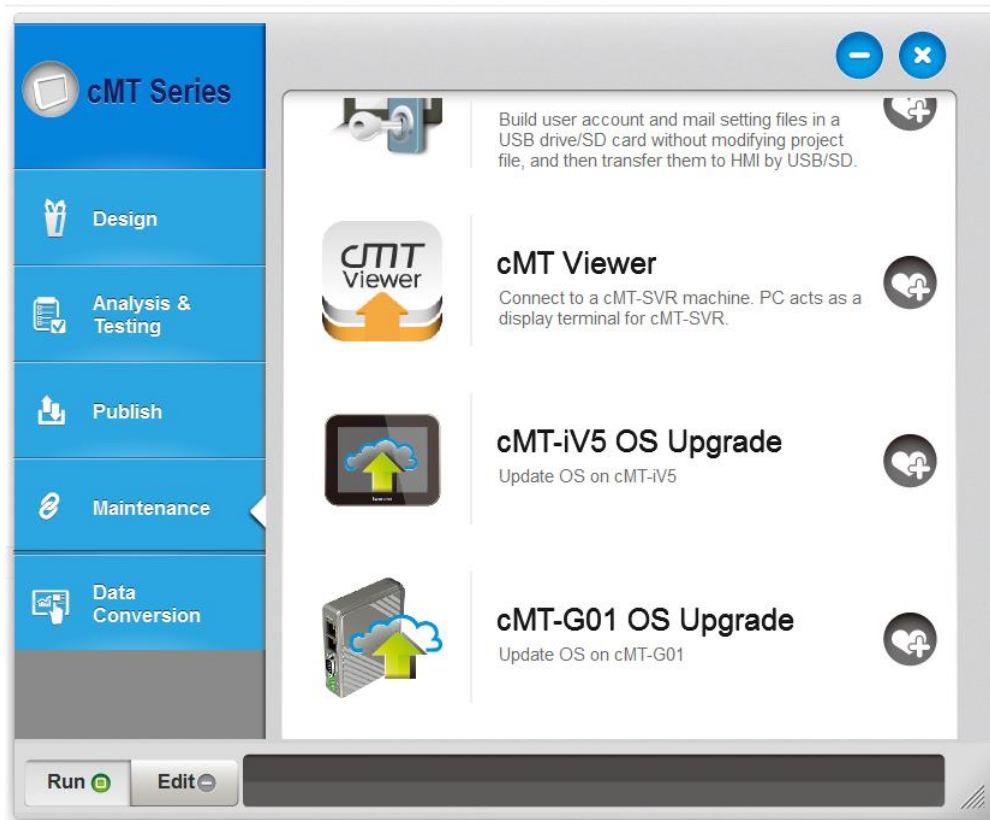

#### 3.1 Updating Web Package

1. Select an HMI to update OS.
2. Select [Web package] and browse for the source file.
3. Click [Update].

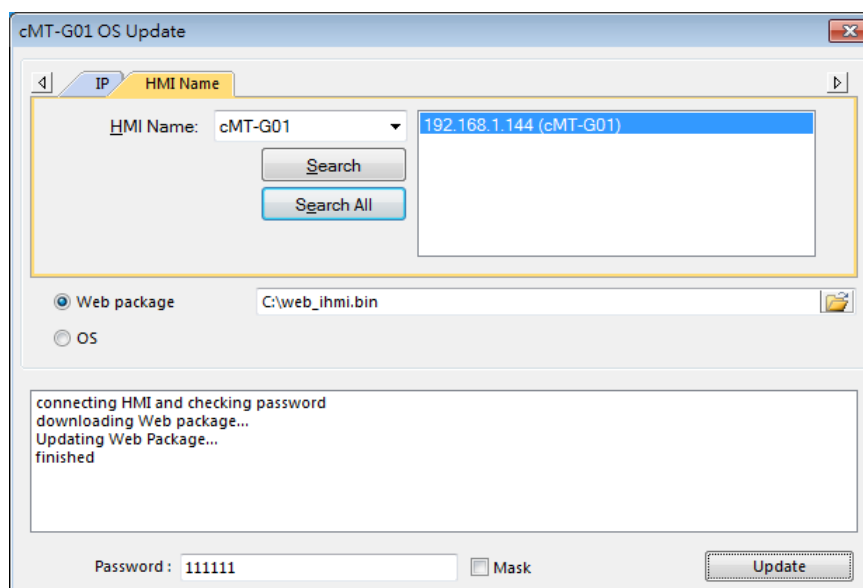

### 3.2 Updating OS

1. Select an HMI to update OS.
2. Select [OS], a Warning message shows, please read this message carefully before you click [OK].

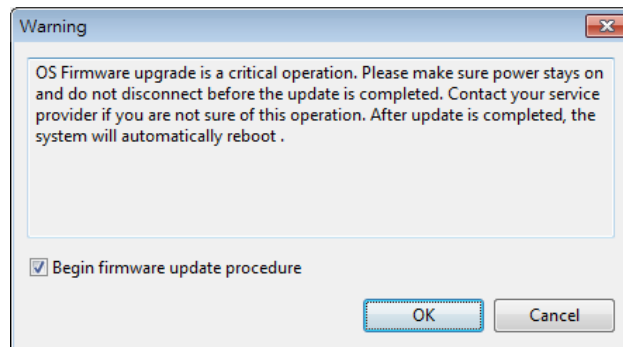

3. If you click [OK], the cMT-G01 OS Update window opens again, browse for the source file, and then click [Update].

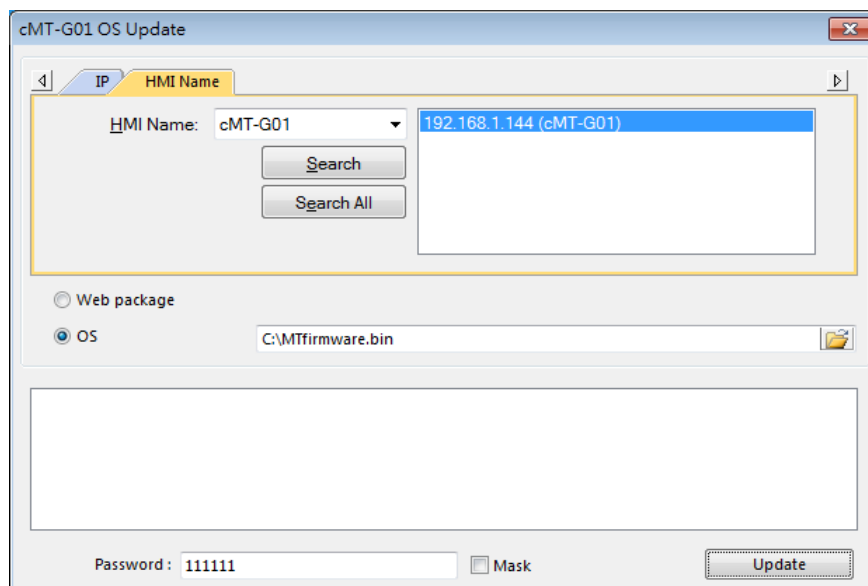

4. The message window below opens, please do not turn off the power while upgrading.

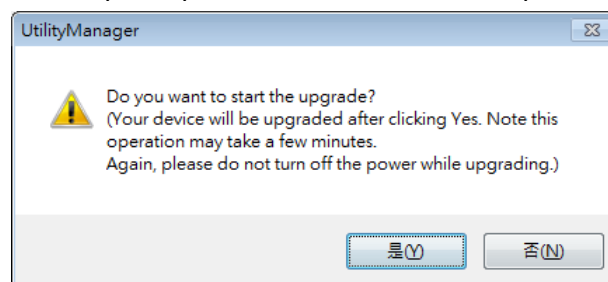

5. When finished, cMT-G01 OS Update window shows "finished".

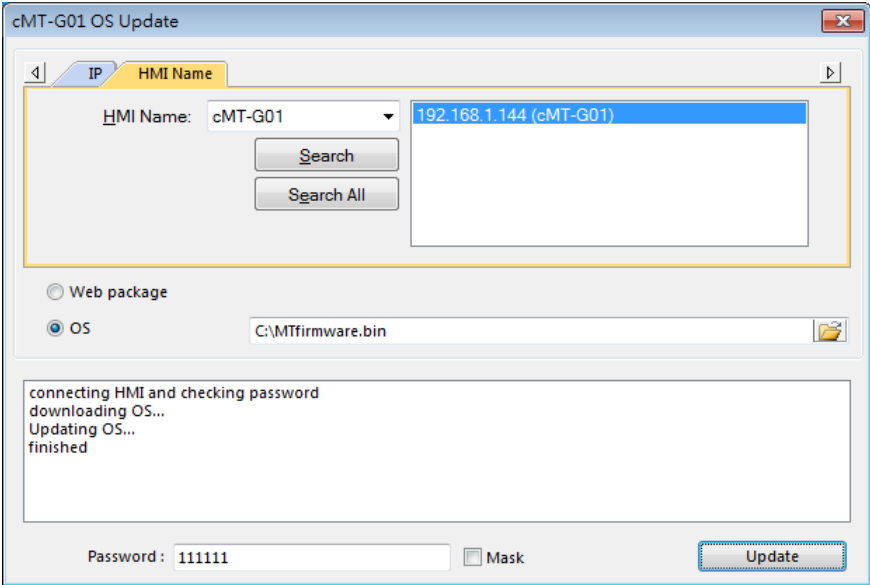

## Chapter4. How to create a cMT-G01/G02 project

This chapter explains how to create a project when cMT-G01/G02 is used as an OPC UA Server, and how to set the addresses used to communicate with OPC UA Clients. The basic steps are:

1. Add a driver into Device List in EasyBuilder Pro.
2. Enable OPC UA Server and designate communication address.
3. Download the project to HMI.

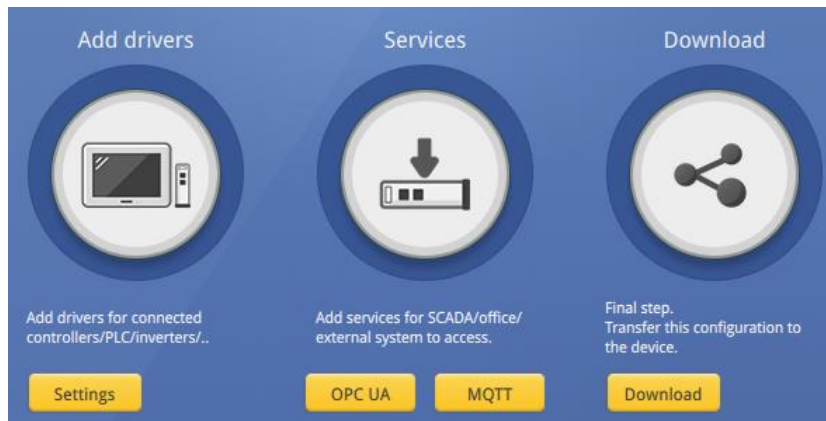

The following explains how to set up OPC UA Server in the project.

### 4.1. Create a new project

- Step 1. Launch EasyBuilder Pro and select a cMT-G01/G02.

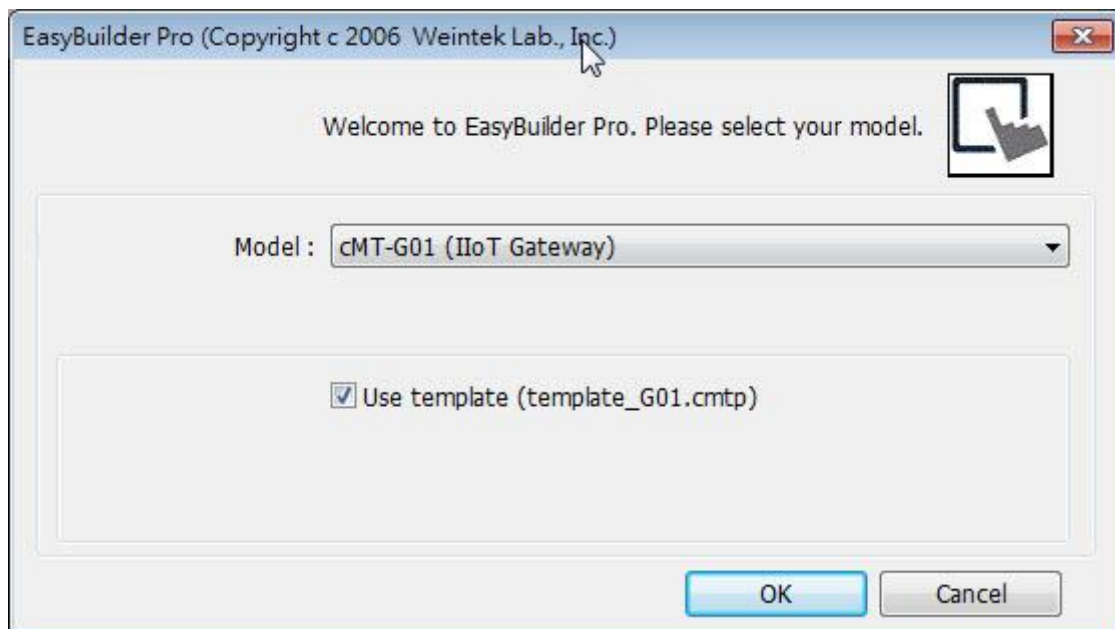

- Step 2. Add a PLC into the Device List.

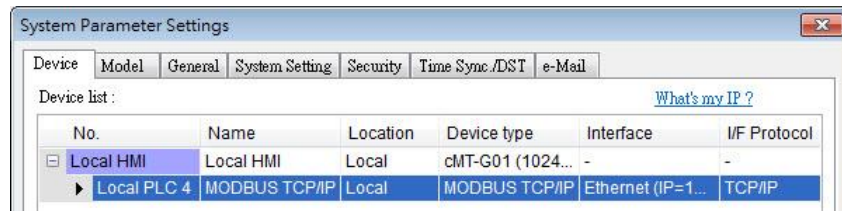

Step 3. Click [IIoT] » [OPC UA Server], and select [Enable] check box to enable OPC UA Server.



Step 4. Click [Tags] of the device and then click [New Tag] to add tags monitored using OPC UA. When finished, click [OK] to leave.

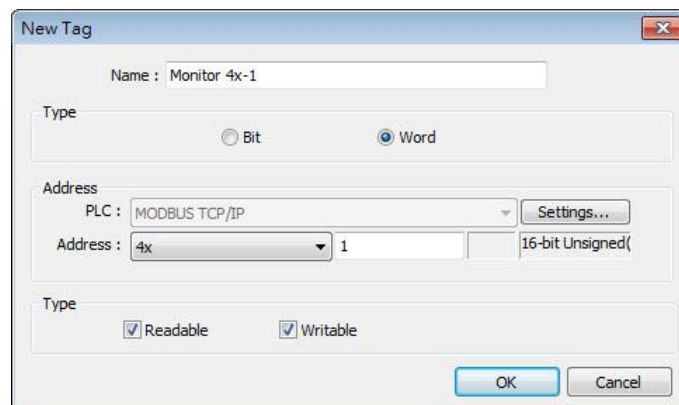

Step 5. Find the created tags in OPC UA Server window. Larger quantity of tags can be exported as csv/excel file and then imported for editing.



## 4.2. Download project to cMT-G01/G02

The format of the project file run on cMT-G01/G02 is \*.cxob. In EasyBuilder Pro, click [Project] » [Compile] to compile the project into \*.cxob format. When finish compiling, you can download the project to cMT-G01/G02 by two ways.

Way 1: Download using EasyBuilder Pro. Click [Project] » [Download], and set HMI IP address. The project can be downloaded via Ethernet.

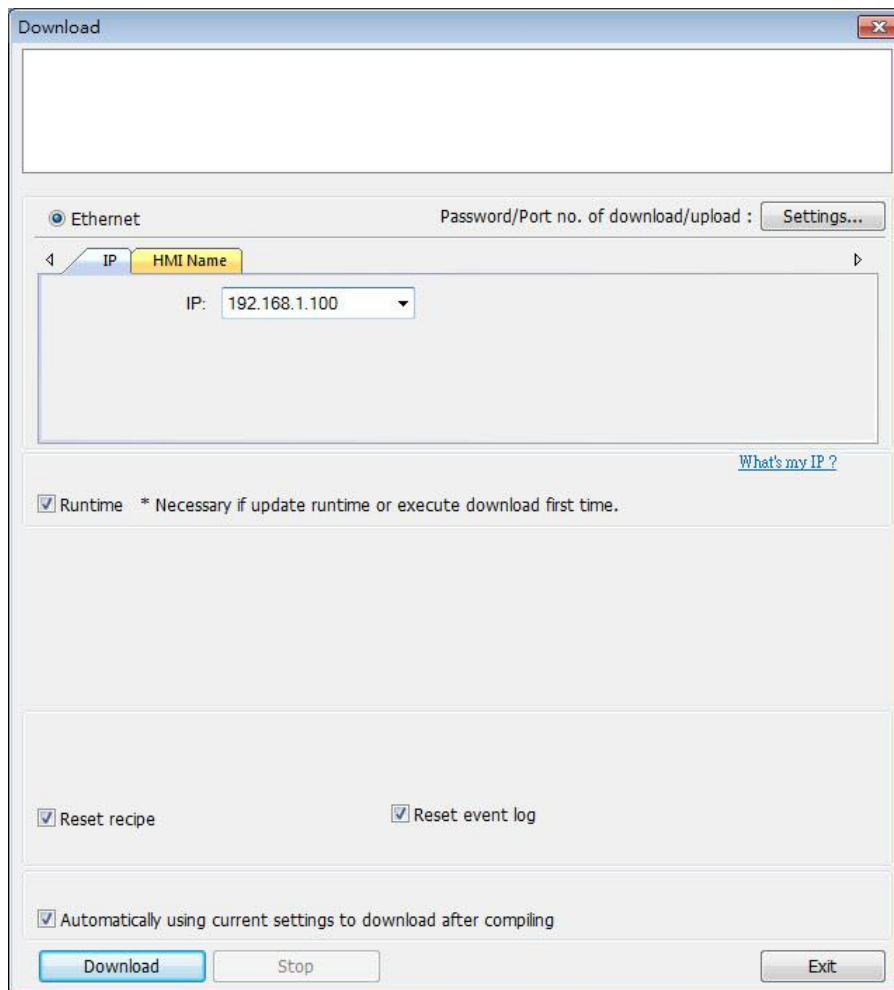

Way 2: Download using website. Open internet browser (IE, Chrome, Firefox), enter cMT-G01/G02 IP address (for example: 192.168.100.1), click System Setting, enter password, and then configure cMT-G01/G02 settings. Go to [Project Management] page and open [Upload Project] tab to download the project file from the computer to cMT-G01/G02.

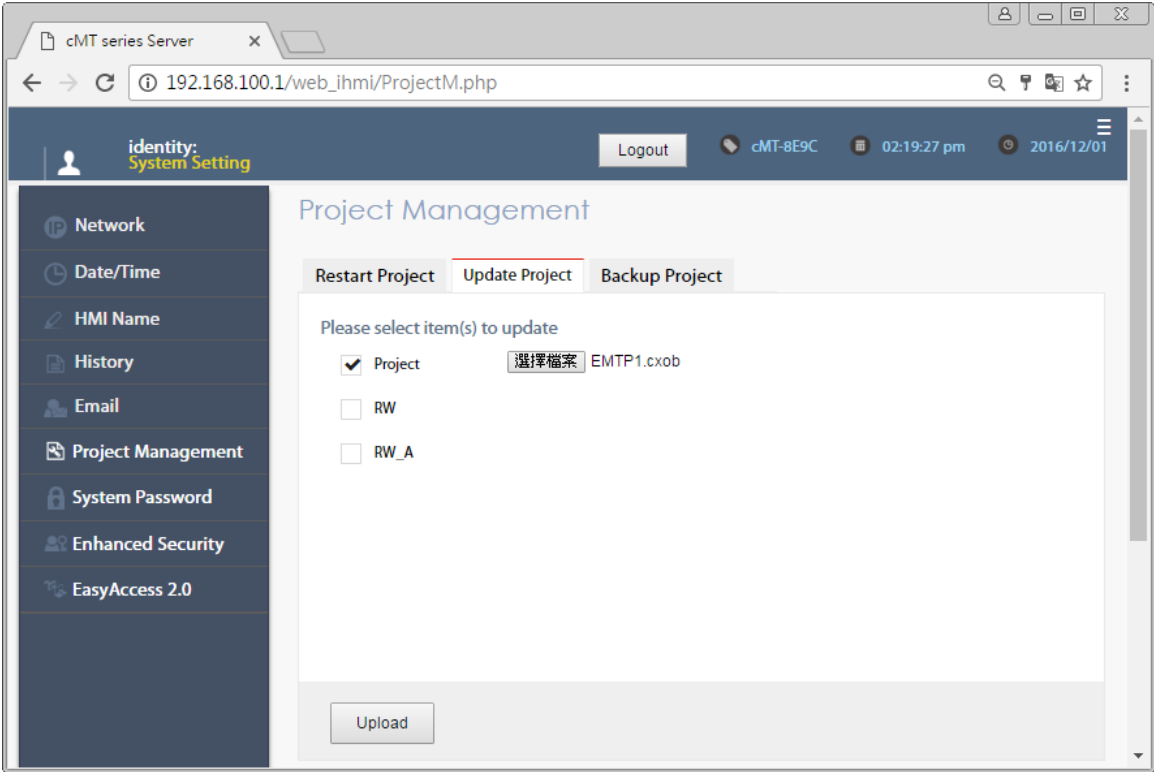

### 4.3. Monitoring OPC UA Client

After downloading the project file to HMI, use OPC UA Client software to connect with cMT-G01/G02 to monitor PLC data.

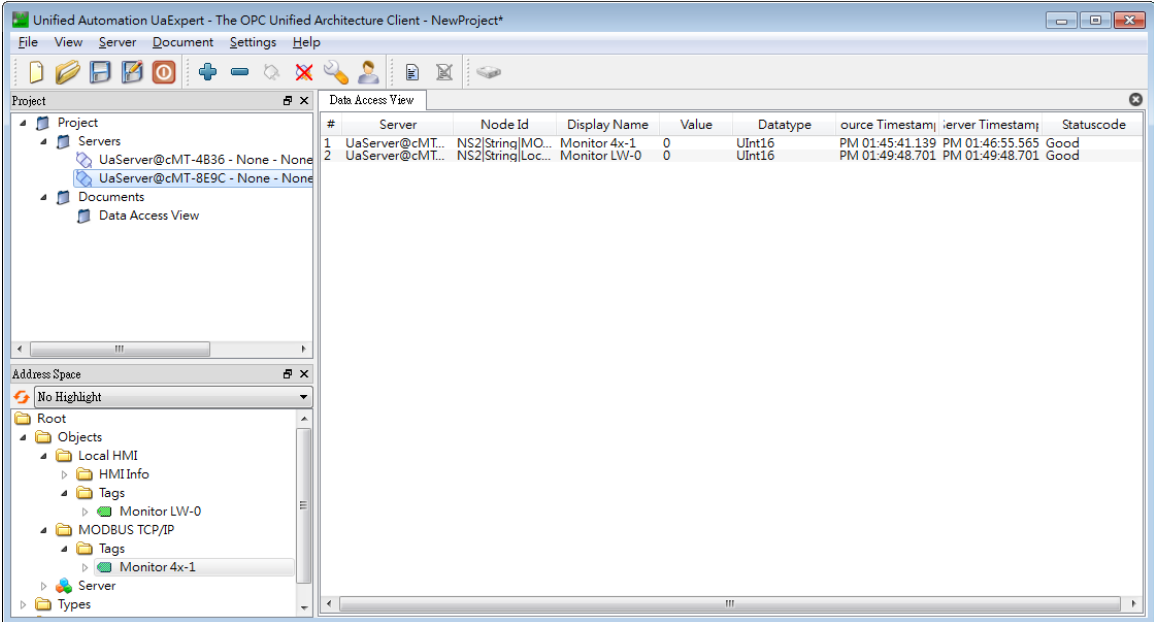

Note: The above is a screenshot of UaExport settings window, for more information on OPC UA Client software settings, please see software’s manual.

### 4.4. On-line/Off-line Simulation

Running On-line or Off-line simulation in EasyBuilder Pro helps you examine OPC UA Tag settings. In



On-line simulation, cMT Gateway Viewer can read from / write to PLC. Please note that On-line simulation is limited to 10 minutes.

Step 1. In EasyBuilder Pro click [Project] » [On-line Simulation] / [Off-line Simulation] to open cMT Gateway Viewer window.

Step 2. Add the tags to be previewed into the Monitor list on the right side.

Step 3. In On-line Simulation, data in PLC tags will also change.

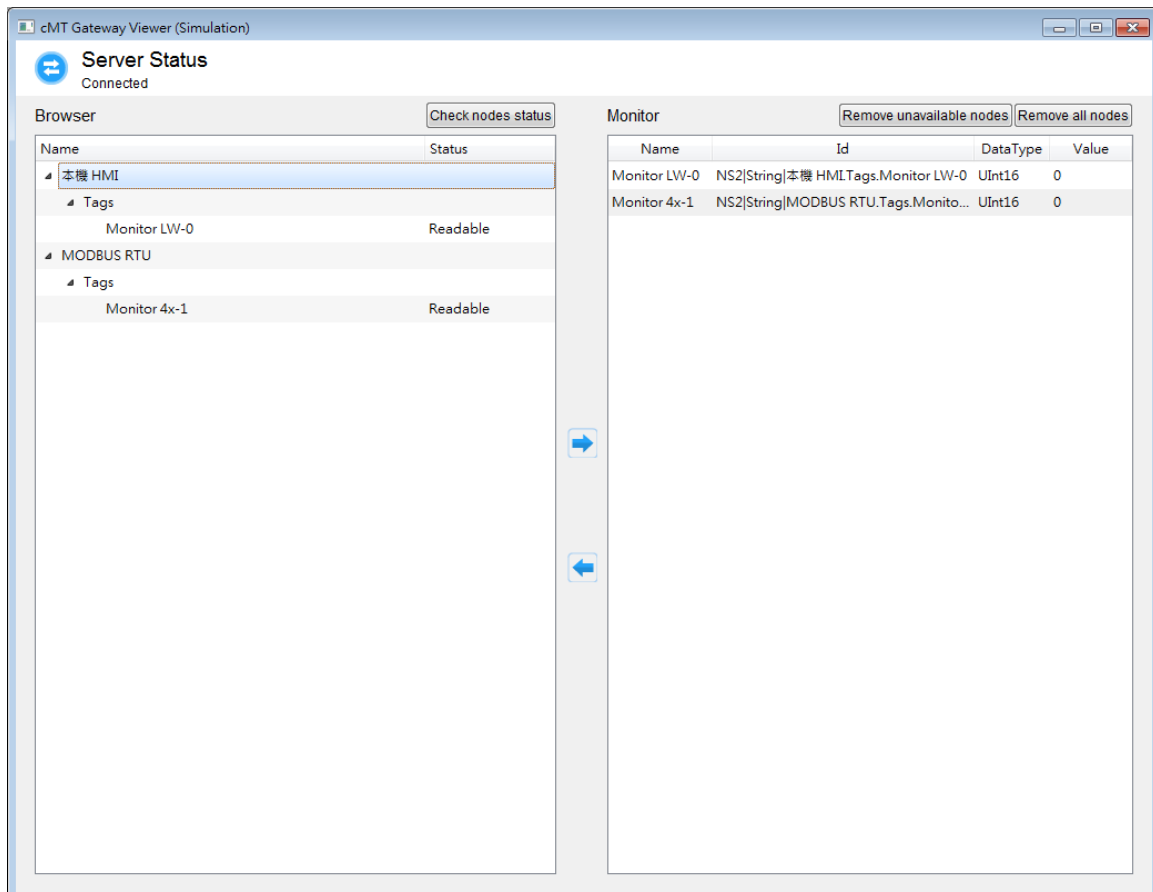

## Chapter5. Functions supported by cMT-G01/G02

- OPC UA Server  
<http://www.weintek.com/download/EBPro/Document/UM016009E OPC UA UserManual en .pdf>
- EasyAccess 2.0
- <http://www.weintek.com/download/EasyAccess20/Manual/eng/EasyAccess2 UserManual en. pdf>
- Modbus TCP/IP Gateway
- MQTT
- Administrator Tools
- Time synchronization (NTP)
- Macro
- Project protection
- Communication with iE/XE/eMT/mTV HMI models.
- Pass-through
- Data Transfer (Global) object
- Off-line / On-line Simulation
- Recipes (RW, RW\_A)
- Event Log (please note that cMT-G01/G02 cannot read history data saved in an external device)
- E-Mail
- Scheduler
- Managing OPC UA and communication parameters using Web interface.

## Chapter6. OPC UA Web Management Interface

### 6.1. Introduction

cMT-G01/G02 provides a web-based tool for convenient access to OPC UA configurations.

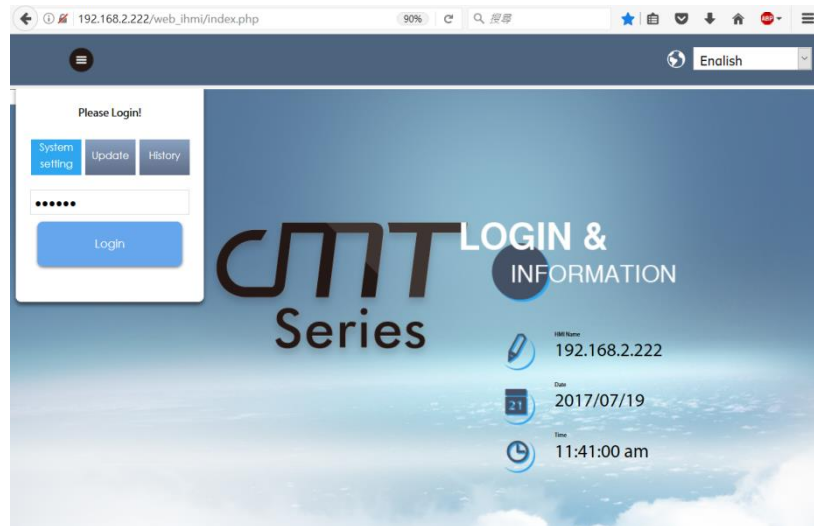

Open cMT-G01/G02's webpage by entering its IP address into the address bar of a web browser. At the entry page, log in with System setting's password. Factory default of the password is 111111. (Suggested resolution: 1024x768 or higher)

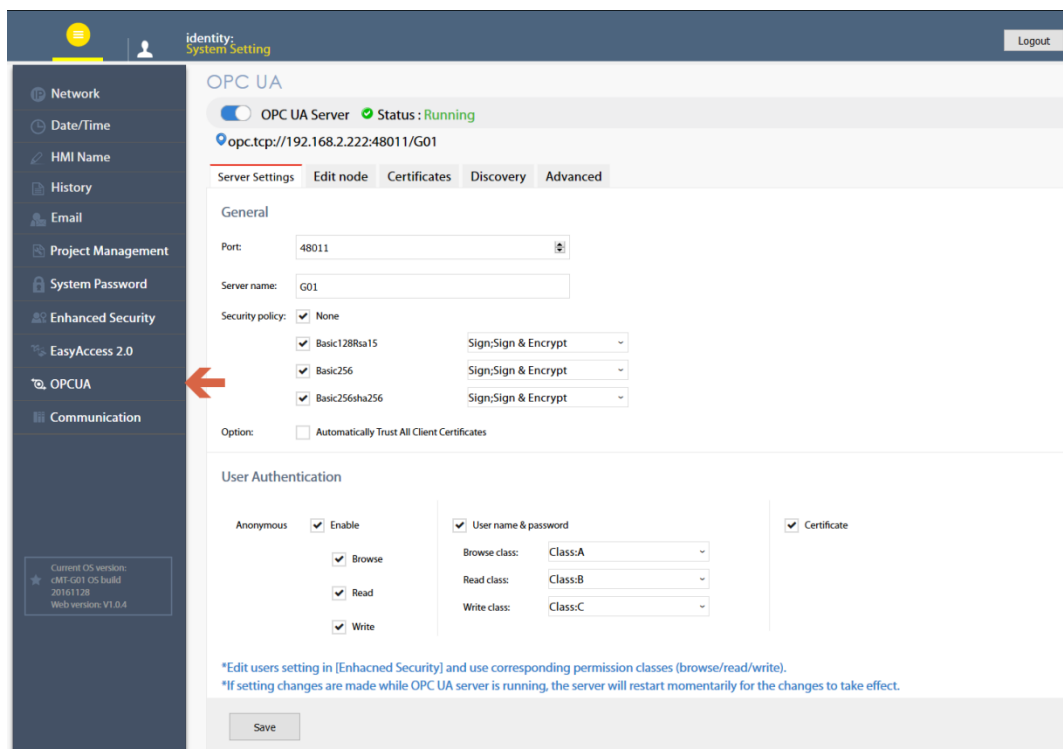

Navigate to the OPC UA configuration page from the context menu on the left.

The OPC UA configuration page consists of a Startup/Shutdown control with status bar and tabbed windows including: Server settings, Edit node, Certificates, Discovery, and Advanced.

Usage of each window tab:

Tab	Description
<b>Server settings</b>	Configure server settings such as port, name, security, user authentication.....etc.
<b>Edit node</b>	Manage tags used by OPC UA server.
<b>Certificates</b>	Manage certificates used by OPC UA server.
<b>Discovery</b>	Manage list of discovery server.
<b>Advanced</b>	Advanced options and features.

## 6.2. Startup / Shut Down

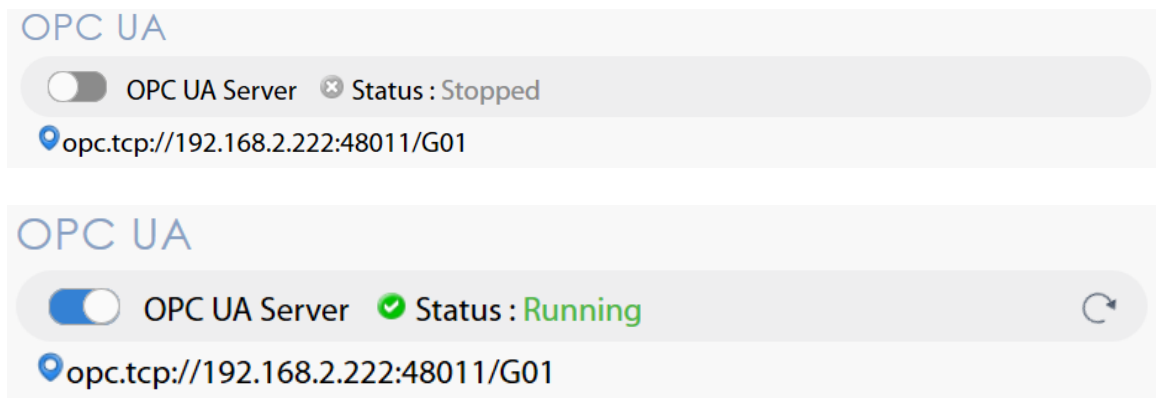

Use the toggle button to start up or shut down the OPC UA server. If there is active client connection, when shutting down, the server will wait for a few seconds before closing off completely.

In addition, both the toggle button and a line of text also indicate the status of the server. The status is refreshed approximately every 10 seconds. An icon on the right  indicates that the status is being refreshed.

Endpoint URL is also displayed for user's reference.

\*Whenever a page refresh is desired, use the menu on the left. Avoid using the browser's refresh button to reload a tab as you may be asked to enter the password to log in again.

## 6.3. Server Settings

The Server settings page shows general configurations of the OPC UA server.

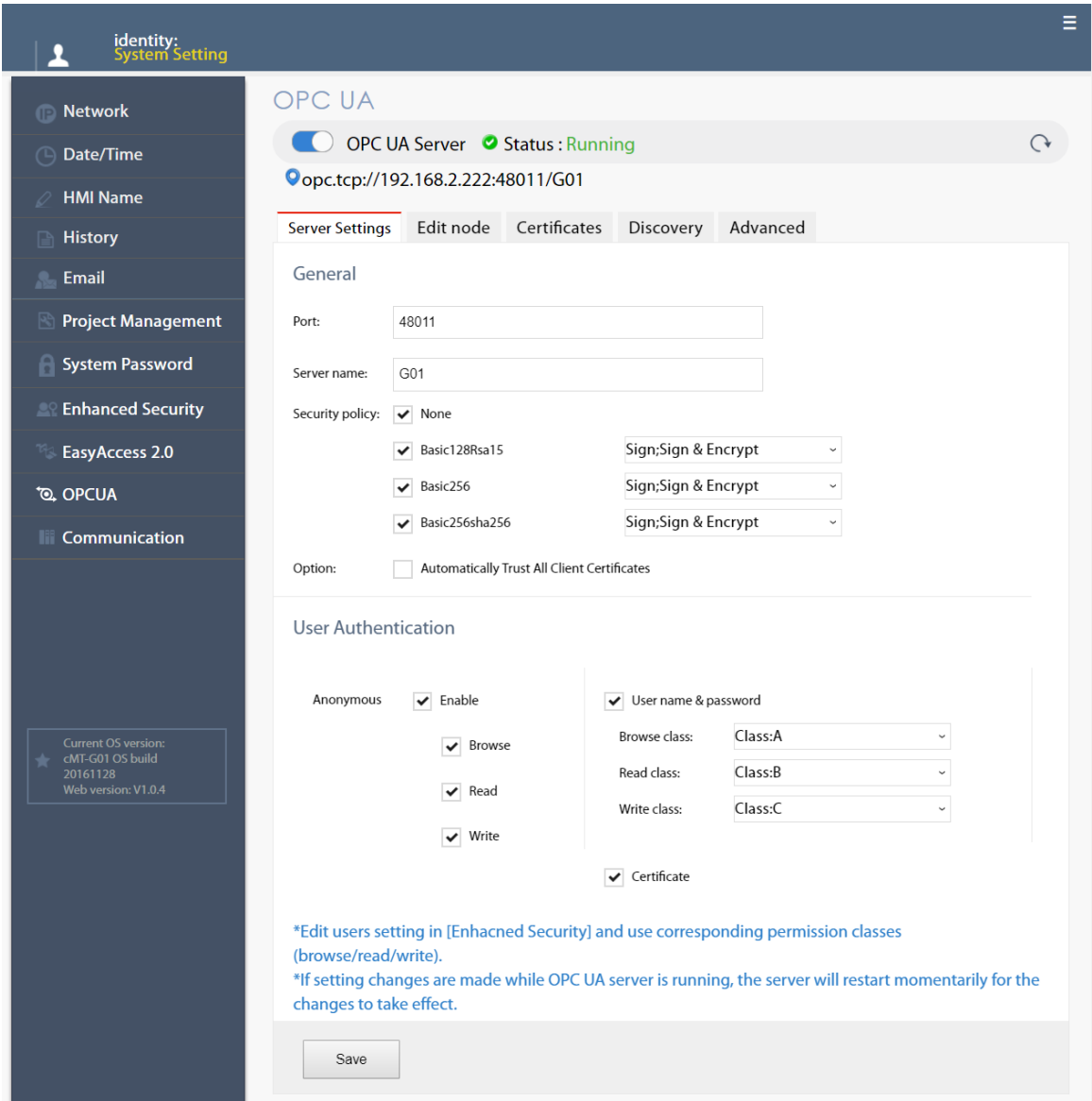

General	Function
<b>Port</b>	Access port of the OPC UA server
<b>Server name</b>	Server name of the OPC UA server
<b>Security policy</b>	Supported security policies. At least one must be selected. Supported Policy: None, Basic128Rsa15, Basic256, Basic256sha256 Mode: Sign, Sign & Encrypt
<b>Option</b>	Automatically Trust all client certificates: by enabling this option, the OPC UA server will trust the certificate from any client connection.

OPC UA server must be configured with at least one user authentication mode as listed in the following table.

Authentication	Descriptions
<b>Anonymous</b>	Allow anonymous client connection. At least one of Browse, Read, or Write modes must be selected.
<b>User name &amp; Password</b>	Allow user authentication with username and password. Each access mode, browse, read, and write can be assigned to a user class. User classes are configured in the Enhanced Security mode on the web interface or in EasyBuilder Pro.
<b>Certificate</b>	User authentication with X.509 certificate

After completing settings, click the Save button to save the changes. OPC UA server will shut down momentarily and then restart for the changes to take effect.

### 6.4. Edit Node

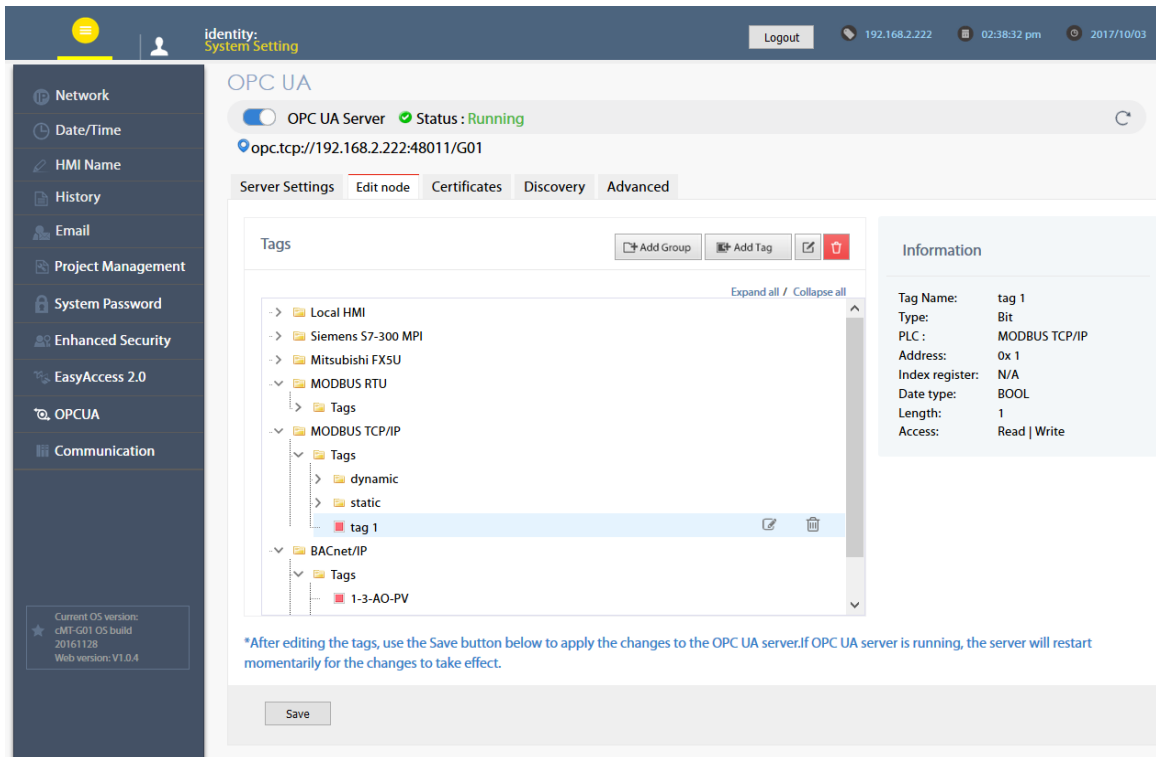

In this page, the user can view and manage the tags currently available in the OPC UA server. New nodes and groups can be added, while existing nodes and groups can be edited or deleted. For ease of navigation, detail information of the currently selected node/group is displayed on the right. After completing settings, it is necessary to click the Save button to save the changes. OPC UA server will shut down momentarily and then restart for the changes to take effect. Changes will be lost if one exits this page without saving.

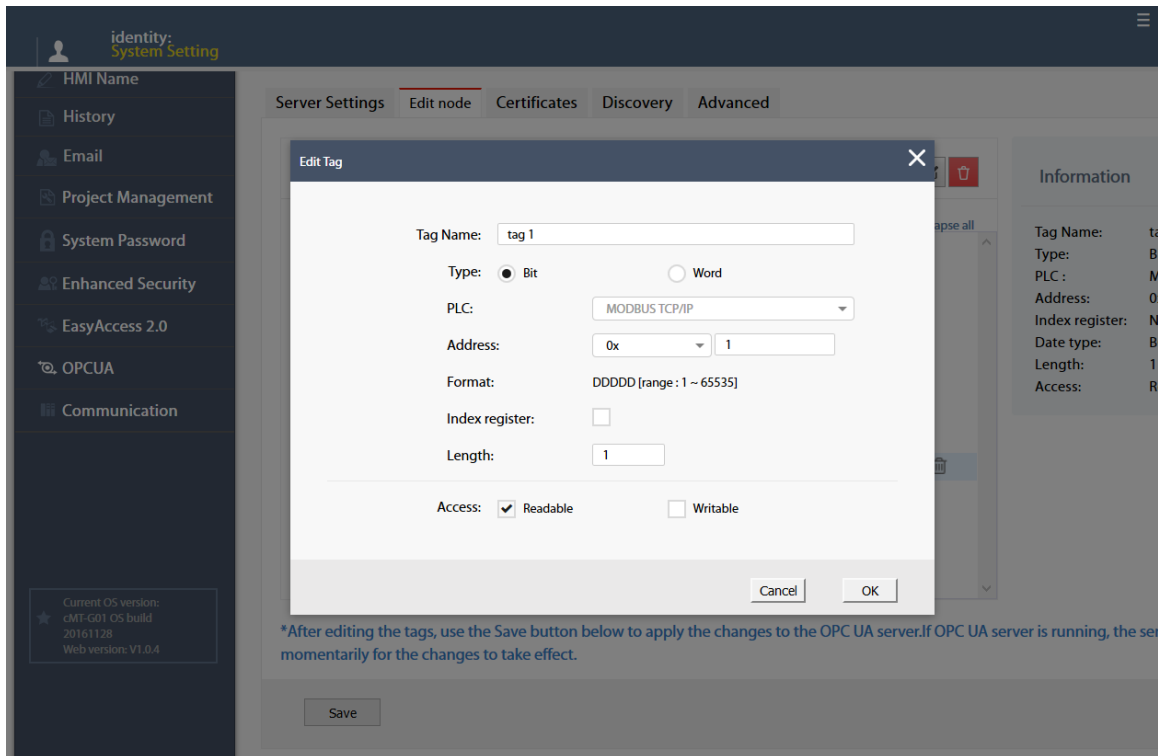

Note that all modifications can only be made for existing drivers. It is not possible to change or add other drivers that are not already available. It is also not possible to edit the nodes used by tag PLCs\*.

\*Tag PLCs are characterized by their use of name tags as device memory address as opposed to using device name with indices. Examples of tag PLCs include: BACnet, Rockwell Free Tag Names , Siemens S7-1200,...etc.

## 6.5. Certificates

In this page, the user can manage certificates and revocation lists of the OPC UA server. Use the dropdown menu to access each page.

If “Allow anonymous client connection” (in the Server settings tab ) option is not active, OPC UA server will reject all client connections and place their certificates in the untrusted list. User may manually “trust” them in this page. Use the reload button  to repopulate the list of certificates if necessary.

Similarly, currently trusted certificates can be manually rejected on the same page.

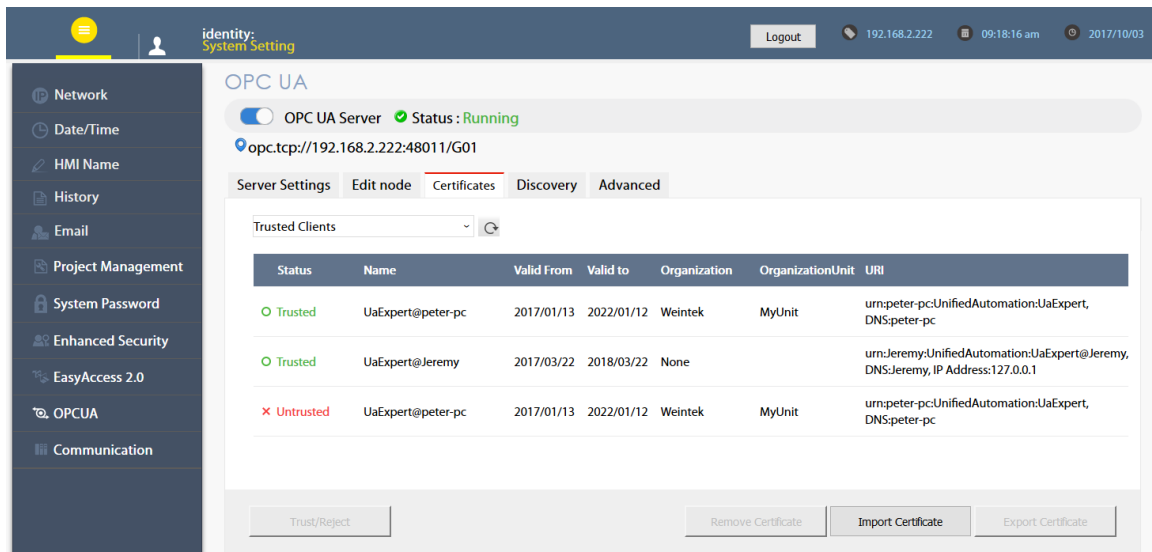

Page	Description
<b>Trusted Clients</b>	Lists of trusted/rejected client certificates on the server. Supported operation: Trust/Reject, Remove, Import, Export.
<b>Trusted Users</b>	Lists of trusted/rejected user certificates on the server. Supported operation: Trust/Reject, Remove, Import, Export.
<b>Own</b>	Server's own certificate. Supported operation: Update, Remove. When updating own certificate, matching certificate and Private Key must be uploaded together; otherwise, update will fail. A self-signed, 20-year validity certificate will be generated automatically if own certificate is absent when server starts up.
<b>Trusted Client Issuers</b>	List of trusted client issuer certificates. Supported operation: Import, Remove, Export.
<b>Trusted User Issues</b>	List of trusted client issuer certificates. Supported operation: Import, Remove, Export.
<b>Certificate Revocation List</b>	Certificate revocation lists for client, user, client issuer, and user issuer. Supported operation: Import, Remove, Export

## 6.6. Discovery

OPC UA server can register itself with Local Discovery Servers. In this page, the user can maintain the list of discovery servers that OPC UA server will register with during startup. Should the discovery server be unavailable during server shutdown, the shutdown process will be slightly delayed.



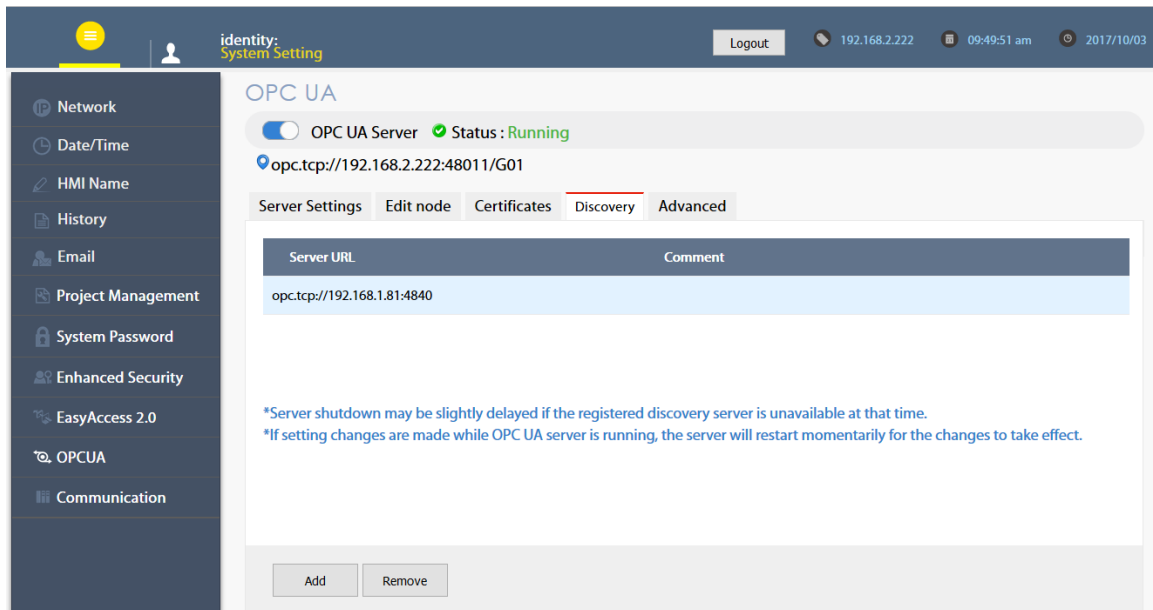

After completing settings, click the Save button to save the changes. OPC UA server will shut down momentarily and then restart for the changes to take effect.

## 6.7. Advanced

Additional settings can be configured in the Advanced tab. The user can set the trace logging level and specific startup behavior of the OPC UA server. Furthermore, the trace log can be downloaded.

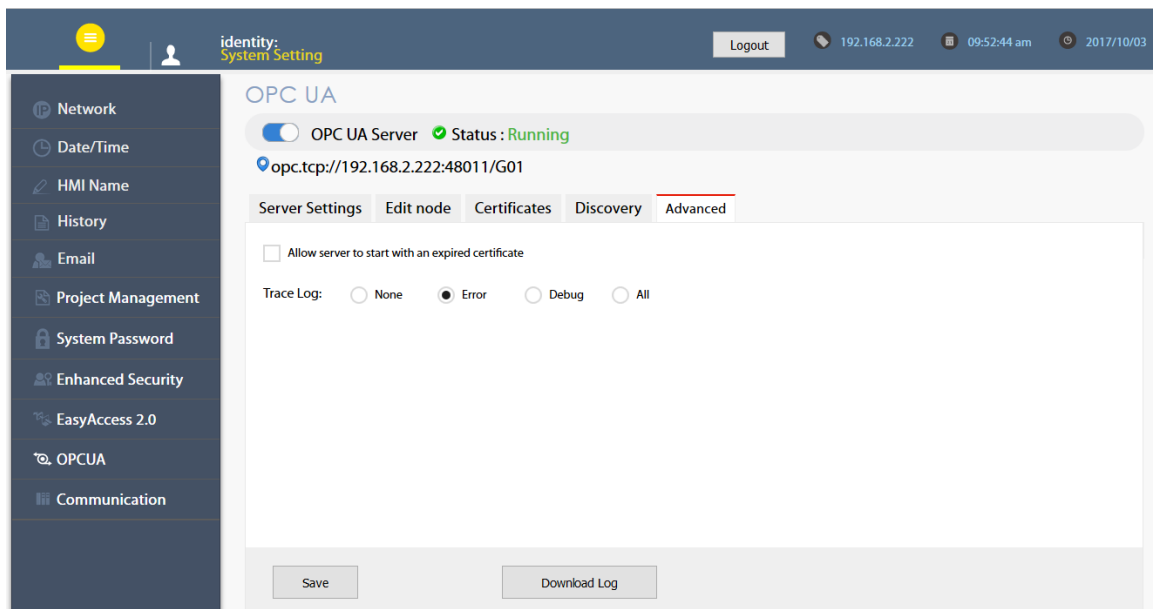

After completing settings, click the Save button to save the changes. OPC UA server will shut down momentarily and then restart for the changes to take effect.